

# Small- signal Transistors

DATA HANDBOOK

B | O | O | K | S | C | O | 4 | 1 | 9 | 9 | 3

Philips Semiconductors



**PHILIPS**

## **QUALITY ASSURED**

Our quality system focuses on the continuing high quality of our components and the best possible service for our customers. We have a three-sided quality strategy: we apply a system of total quality control and assurance; we operate customer-oriented dynamic improvement programmes; and we promote a partnering relationship with our customers and suppliers.

## **PRODUCT SAFETY**

In striving for state-of-the-art perfection, we continuously improve components and processes with respect to environmental demands. Our components offer no hazard to the environment in normal use when operated or stored within the limits specified in the data sheet.

Some components unavoidably contain substances that, if exposed by accident or misuse, are potentially hazardous to health. Users of these components are informed of the danger by warning notices in the data sheets supporting the components. Where necessary the warning notices also indicate safety precautions to be taken and disposal instructions to be followed. Obviously users of these components, in general the set-making industry, assume responsibility towards the consumer with respect to safety matters and environmental demands.

All used or obsolete components should be disposed of according to the regulations applying at the disposal location. Depending on the location, electronic components are considered to be 'chemical', 'special' or sometimes 'industrial' waste. Disposal as domestic waste is usually not permitted.



	page
<b>SELECTION GUIDE</b>	
General purpose applications	4
HF applications	12
Switching applications	14
High voltage applications	22
Programmable unijunction transistors	24
Silicon controlled switches	24
<b>CONVERSION LIST (lead to SMD type numbers)</b>	28
<b>GENERAL</b>	
Pro-electron type numbering system for semiconductor devices	37
Rating systems	39
Letter symbols for transistors and signal diodes	41
Transistor safe operating area	47
Soldering recommendations	63
Packing	64
<b>DEVICE DATA (in alphanumeric sequence)</b>	71
<b>INDEX</b>	829
<b>DATA HANDBOOK SYSTEM</b>	

## DEFINITIONS

<b>Data sheet status</b>	
Objective specification	This data sheet contains target or goal specifications for product development.
Preliminary specification	This data sheet contains preliminary data; supplementary data may be published later.
Product specification	This data sheet contains final product specifications.
<b>Limiting values</b>	
Limiting values given are in accordance with the Absolute Maximum Rating System (IEC 134). Stress above one or more of the limiting values may cause permanent damage to the device. These are stress ratings only and operation of the device at these or at any other conditions above those given in the Characteristics sections of this specification is not implied. Exposure to limiting values for extended periods may affect device reliability.	
<b>Application information</b>	
Where application information is given, it is advisory and does not form part of the specification.	

## SELECTION GUIDE

## Small-signal Transistors

## Selection guide

## GENERAL PURPOSE APPLICATIONS

TYPE	POLARITY	CASE	$V_{CE0}$ (V)	$I_c$ (mA)	$P_{tot}$ (mW)	at $T_{amb}$ ( $T_{case}$ ) (°C)
BC107	NPN	TO-18	45	100	300	25
BC108	NPN	TO-18	20	100	300	25
BC109	NPN	TO-18	20	100	300	25
BC140	NPN	TO-39	40	1000	3700	(45)
BC141	NPN	TO-39	60	1000	3700	(45)
BC160	PNP	TO-39	40	1000	3700	(45)
BC161	PNP	TO-39	60	1000	3700	(45)
BC177	PNP	TO-18	45	100	300	25
BC178	PNP	TO-18	25	100	300	25
BC179	PNP	TO-18	20	100	300	25
BC327	PNP	TO-92	45	500	800	25
BC327A	PNP	TO-92	60	500	800	25
BC328	PNP	TO-92	25	500	800	25
BC337	NPN	TO-92	45	500	800	25
BC337A	NPN	TO-92	60	500	800	25
BC338	NPN	TO-92	25	500	800	25
BC368	NPN	TO-92	20	1000	800	25
BC369	PNP	TO-92	20	1000	800	25
BC375	NPN	TO-92	30	1000	800	25
BC376	PNP	TO-92	30	1000	800	25
BC516	PNP	TO-92	30	400	625	25
BC517	NPN	TO-92	30	400	625	25
BC546	NPN	TO-92	65	100	500	25
BC547	NPN	TO-92	45	100	500	25
BC548	NPN	TO-92	30	100	500	25
BC549	NPN	TO-92	30	100	500	25
BC550	NPN	TO-92	45	100	500	25
BC556	PNP	TO-92	65	100	500	25
BC557	PNP	TO-92	45	100	500	25
BC558	PNP	TO-92	30	100	500	25
BC559	PNP	TO-92	30	100	500	25
BC560	PNP	TO-92	45	100	500	25
BC617	NPN	TO-92	40	1000	625	25
BC618	NPN	TO-92	55	1000	625	25
BC635	NPN	TO-92	45	1000	1000	25
BC637	NPN	TO-92	60	1000	1000	25
BC639	NPN	TO-92	80	1000	1000	25

## Small-signal Transistors

## Selection guide

TYPE	$h_{FE}$ ( $h_{ie}$ )	at $I_C$ (mA)	$f_T$ typ. (MHz)	F typ. (dB)	REMARKS	PAGE
BC107	(125 - 500)	2	300	2		71
BC108	(125 - 900)	2	300	2		71
BC109	(240 - 900)	2	300	1.2	low-noise type	71
BC140	100 - 250	100	> 50	-		85
BC141	100 - 250	100	> 50	-		85
BC160	100 - 250	100	> 50	-		89
BC161	100 - 250	100	> 50	-		89
BC177	(75 - 260)	2	150	-		93
BC178	(125 - 500)	2	150	-		93
BC179	(125 - 500)	2	150	1.2	low-noise type	93
BC327	100 - 600	100	100	-	driver and output stage	105
BC327A	100 - 600	100	100	-	driver and output stage	105
BC328	100 - 600	100	100	-	driver and output stage	105
BC337	100 - 600	100	100	-	driver and output stage	111
BC337A	100 - 600	100	100	-	driver and output stage	111
BC338	100 - 600	100	100	-	driver and output stage	111
BC368	85 - 375	500	40	-	class-B audio output stage	117
BC369	85 - 375	500	40	-	class-B audio output stage	125
BC375	60 - 340	150	150	-	output stage	133
BC376	60 - 340	150	100	-	output stage	135
BC516	> 30 000	20	220	-	Darlington transistors	137
BC517	> 30 000	20	220	-	Darlington transistors	139
BC546	110 - 450	2	300	2	driver stage audio amplifier	141
BC547	110 - 800	2	300	2	driver stage audio amplifier	141
BC548	110 - 800	2	300	2	driver stage audio amplifier	141
BC549	200 - 800	2	300	1.4	low-noise stage	149
BC550	200 - 800	2	300	1.4	low-noise stage	149
BC556	75 - 475	2	200	2	driver stage audio amplifier	159
BC557	75 - 800	2	200	2	driver stage audio amplifier	159
BC558	75 - 800	2	200	2	driver stage audio amplifier	159
BC559	125 - 800	2	200	1.2	low-noise type	165
BC560	125 - 800	2	200	1.0	low-noise type	165
BC617	> 4000	1	>155	-	driver stage	173
BC618	> 2000	1	>155	-	driver stage	173
BC635	40 - 250	150	130	-	driver stage	175
BC637	40 - 160	150	130	-	driver stage	175
BC639	40 - 160	150	130	-	driver stage	175

## Small-signal Transistors

## Selection guide

## GENERAL PURPOSE APPLICATIONS (Continued)

TYPE	POLARITY	CASE	$V_{CE0}$ (V)	$I_C$ (mA)	$P_{tot}$ (mW)	at $T_{amb}$ ( $T_{case}$ ) (°C)
BC636	PNP	TO-92	45	1000	1000	25
BC638	PNP	TO-92	60	1000	1000	25
BC640	PNP	TO-92	80	1000	1000	25
BC875	NPN	TO-92	45	1000	800	25
BC877	NPN	TO-92	60	1000	800	25
BC879	NPN	TO-92	80	1000	800	25
BC876	PNP	TO-92	45	1000	800	25
BC878	PNP	TO-92	60	1000	800	25
BC880	PNP	TO-92	80	1000	800	25
BCX22	NPN	TO-18	125	800	450	25
BCX23	NPN	TO-18	125	800	450	25
BCY56	NPN	TO-18	45	100	300	25
BCY57	NPN	TO-18	20	100	300	25
BCY58	NPN	TO-18	32	200	330	45
BCY59	NPN	TO-18	45	200	330	45
BCY70	PNP	TO-18	40	200	350	25
BCY71	PNP	TO-18	45	200	350	25
BCY72	PNP	TO-18	25	200	350	25
BCY78	PNP	TO-18	32	200	345	45
BCY79	PNP	TO-18	45	200	345	45
BCY87	NPN	TO-71	40	30	150	25
BCY88	NPN	TO-71	40	30	150	25
BCY89 (note 1)	NPN	TO-71	40	30	150	25
JA100	PNP	TO-92	25	100	500	25
JA101	PNP	TO-92	45	100	500	25
JC327	PNP	TO-92	45	1000	800	25
JC327A	PNP	TO-92	60	1000	800	25
JC328	PNP	TO-92	25	1000	800	25
JC337	NPN	TO-92	45	1000	800	25
JC337A	NPN	TO-92	60	1000	800	25
JC338	NPN	TO-92	25	1000	800	25
JC500	NPN	TO-92	25	100	500	25
JC501	NPN	TO-92	45	100	500	25
JC546	NPN	TO-92	65	100	500	25
JC547	NPN	TO-92	45	100	500	25
JC548	NPN	TO-92	30	100	500	25

## Small-signal Transistors

## Selection guide

TYPE	$h_{FE}$ ( $h_{ie}$ )	at $I_C$ (mA)	$f_T$ typ. (MHz)	F typ. (dB)	REMARKS	PAGE
BC636	40 - 250	150	50	-	driver stage	181
BC638	40 - 250	150	50	-	driver stage	181
BC640	40 - 250	150	50	-	driver stage	181
BC875	> 1000	150	200	-	driver stage	187
BC877	> 1000	150	200	-	driver stage	187
BC879	> 1000	150	200	-	driver stage	187
BC876	> 1000	150	200	-	driver stage	191
BC878	> 1000	150	200	-	driver stage	191
BC880	> 1000	150	200	-	driver stage	191
BCX22	>63	100	100	-		195
BCX23	>63	100	100	-		199
BCY56	100 - 450	2	85	1.5	low-noise type	211
BCY57	200 - 800	2	100	1.5	low-noise type	211
BCY58	(125 - 700)	2	> 150	2.0	switching	215
BCY59	(125 - 700)	2	> 150	2.0	switching	215
BCY70	> 100	10	> 250	< 6	low-noise type	229
BCY71	> 100	10	> 250	< 2	low-noise type	229
BCY72	> 100	10	> 250	< 6	low-noise type	229
BCY78	(125 - 700)	2	180	2.0	switching	245
BCY79	(125 - 700)	2	180	2.0	switching	245
BCY87	100 - 450	0.05	> 10	< 3	pre-stages of differential amplifier	253
BCY88	100 - 450	0.05	> 10	< 4	long-tailed pairs	253
BCY89	100 - 450	0.05	> 10	< 4		253
JA100	90 - 600	1	130	< 10	centre collector	569
JA101	90 - 600	1	130	< 10	centre collector	569
JC327	100 - 600	100	100	-	centre collector	573
JC327A	100 - 600	100	100	-	centre collector	573
JC328	100 - 600	100	100	-	centre collector	573
JC337	100 - 600	100	100	-	centre collector	577
JC337A	100 - 600	100	100	-	centre collector	577
JC338	100 - 600	100	100	-	centre collector	577
JC500	90 - 600	1	130	< 10	centre collector	581
JC501	90 - 600	1	130	< 10	centre collector	581
JC546	110 - 450	2	300	2.0	centre collector	585
JC547	110 - 800	2	300	2.0	centre collector	585
JC548	110 - 800	2	300	2.0	centre collector	585

## Small-signal Transistors

## Selection guide

## GENERAL PURPOSE APPLICATIONS (Continued)

TYPE	POLARITY	CASE	$V_{CE0}$ (V)	$I_C$ (mA)	$P_{tot}$ (mW)	at $T_{amb}$ ( $T_{case}$ ) (°C)
JC549	NPN	TO-92	30	200	500	25
JC550	NPN	TO-92	45	200	500	25
JC556	PNP	TO-92	65	100	500	25
JC557	PNP	TO-92	45	100	500	25
JC558	PNP	TO-92	30	100	500	25
JC559	PNP	TO-92	30	200	500	25
JC560	PNP	TO-92	45	200	500	25
MPS3702	PNP	TO-92	25	600	625	25
MPS3703	PNP	TO-92	30	600	625	25
MPS3704	NPN	TO-92	30	600	625	25
MPS3705	NPN	TO-92	30	600	625	25
MPS3706	NPN	TO-92	20	600	625	25
MPS6513	NPN	TO-92	30	100	625	25
MPS6514	NPN	TO-92	25	100	625	25
MPS6515	NPN	TO-92	25	100	625	25
MPS6517	PNP	TO-92	40	100	625	25
MPS6518	PNP	TO-92	40	100	625	25
MPS6519	PNP	TO-92	25	100	625	25
MPS6520	NPN	TO-92	25	100	625	25
MPS6521	NPN	TO-92	25	100	625	25
MPS6522	PNP	TO-92	25	100	625	25
MPS6523	PNP	TO-92	25	100	625	25
MPS6531	NPN	TO-92	40	30	625	25
MPS6532	NPN	TO-92	40	30	625	25
MPS6534	PNP	TO-92	40	30	625	25
MPS6535	PNP	TO-92	30	30	625	25
MPSA05	NPN	TO-92	60	500	625	25
MPSA06	NPN	TO-92	80	500	625	25
MPSA55	PNP	TO-92	60	500	625	25
MPSA56	PNP	TO-92	80	500	625	25
2N930	NPN	TO-18	45	30	300	25
2N2483	NPN	TO-18	60	50 (note 2)	360	25
2N2484	NPN	TO-18	60	50 (note 2)	360	25



## Small-signal Transistors

## Selection guide

TYPE	$h_{FE}$ ( $h_{fe}$ )	at $I_C$ (mA)	$f_T$ typ. (MHz)	F typ. (dB)	REMARKS	PAGE
JC549	200 - 800	2	300	1.4	centre collector	595
JC550	200 - 800	2	300	1.4	centre collector	595
JC556	75 - 475	2	200	2.0	centre collector	599
JC557	75 - 800	2	200	2.0	centre collector	599
JC558	75 - 800	2	200	2.0	centre collector	599
JC559	125 - 800	2	200	1.2	centre collector	603
JC560	125 - 800	2	200	1.0	centre collector	603
MPS3702	60 - 300	50	>100	-		609
MPS3703	30 - 150	50	>100	-		609
MPS3704	100 - 300	50	100	-		611
MPS3705	50 - 150	50	100	-		611
MPS3706	30 - 600	50	100	-		611
MPS6513	> 60	100	-	-		621
MPS6514	> 90	100	-	-		621
MPS6515	> 150	100	-	-		621
MPS6517	> 60	100	-	-		623
MPS6518	> 90	100	-	-		623
MPS6519	> 150	100	-	-		623
MPS6520	200 - 400	2	-	< 3	low-noise amplifier	625
MPS6521	300 - 600	2	-	< 3	low-noise amplifier	625
MPS6522	200 - 400	2	-	< 3	low-noise amplifier	627
MPS6523	400 - 600	2	-	< 3	low-noise amplifier	627
MPS6531	90 - 270	100	-	-		629
MPS6532	> 30	100	-	-		629
MPS6534	90 - 270	100	-	-		631
MPS6535	> 30	100	-	-		631
MPSA05	> 50	10	> 100	-	driver stage	633
MPSA06	> 50	10	> 100	-	driver stage	633
MPSA55	> 50	10	> 50	-	driver stage	641
MPSA56	> 50	10	> 50	-	driver stage	641
2N930	150 - 600	10	80	2.0	low-level, low-noise amplifier	685
2N2483	< 500	10	80	4	low-level, low-noise amplifier	729
2N2484	< 800	10	80	3	low-level, low-noise amplifier	729

## Small-signal Transistors

## Selection guide

## GENERAL PURPOSE APPLICATIONS (Continued)

TYPE	POLARITY	CASE	$V_{CE0}$ (V)	$I_C$ (mA)	$P_{tot}$ (mW)	at $T_{amb}$ ( $T_{case}$ ) (°C)
2N4030	PNP	TO-39	60	1000	800	25
2N4031	PNP	TO-39	80	1000	800	25
2N4032	PNP	TO-39	60	1000	800	25
2N4033	PNP	TO-39	80	1000	800	25
2N4123	NPN	TO-92	30	200	350	25
2N4124	NPN	TO-92	25	200	350	25
2N4125	PNP	TO-92	30	200	350	25
2N4126	PNP	TO-92	25	200	350	25
2N4400	NPN	TO-92	40	600	625	25
2N4401	NPN	TO-92	40	600	625	25
2N4402	PNP	TO-92	40	600	625	25
2N4403	PNP	TO-92	40	600	625	25
2N5086	PNP	TO-92	50	50	625	25
2N5087	PNP	TO-92	50	50	625	25
2N5088	NPN	TO-92	30	50	625	25
2N5680	PNP	TO-39	120	1000	1000	25
2PA733	PNP	TO-92	50	100	500	25
2PA1015	PNP	TO-92	50	150	500	25
2PA1015L	PNP	TO-92	50	150	500	25
2PC945	NPN	TO-92	50	100	500	25
2PC1815	NPN	TO-92	50	150	500	25
2PC1815L	NPN	TO-92	50	150	500	25

## Small-signal Transistors

## Selection guide

TYPE	$h_{FE}$ ( $h_{fe}$ )	at $I_C$ (mA)	$f_T$ typ. (MHz)	F typ. (dB)	REMARKS	PAGE
2N4030	40 - 120	100	> 100	-	large-signal, low-noise, low-power	779
2N4031	40 - 120	100	> 100	-	large-signal, low-noise, low-power	779
2N4032	100 - 300	150	> 150	-	large-signal, low-noise, low-power	779
2N4033	100 - 300	150	> 150	-	large-signal, low-noise, low-power	779
2N4123	(50 - 200)	2	> 250	6	small-signal, low-power	785
2N4124	(120 - 480)	2	> 300	5	small-signal, low-power	785
2N4125	(50 - 200)	2	> 200	5	small-signal, low-power	787
2N4126	(120 - 480)	2	> 250	4	small-signal, low-power	787
2N4400	50 - 150	100	> 200	-	driver stage	789
2N4401	100 - 300	100	> 250	-	driver stage	789
2N4402	50 - 150	150	> 150	-	driver stage	793
2N4403	100 - 300	150	> 200	-	driver stage	793
2N5086	150	1	> 40	3	low-noise	797
2N5087	250	1	> 40	2	low-noise	797
2N5088	350	1	> 50	3	low-noise	801
2N5680	40 - 150	250	> 30	-		815
2PA733	90 - 600	1	> 100	6		819
2PA1015	120 - 700	2	> 80	10		821
2PA1015L	120 - 700	2	> 80	6		821
2PC945	90 - 600	1	> 150	15		823
2PC1815	120 - 700	2	> 80	1		825
2PC1815L	120 - 700	2	> 80	0.2		825

## Small-signal Transistors

## Selection guide

## HF APPLICATIONS

TYPE	POLARITY	CASE	$V_{CE0}$ (V)	$I_C$ (mA)	$P_{tot}$ (mW)	at $T_{amb}$ (°C)
BF198	NPN	TO-92	30	25	500	25
BF199	NPN	TO-92	25	25	500	25
BF240	NPN	TO-92	40	25	250	25
BF241	NPN	TO-92	40	25	250	25
BF324	PNP	TO-92	30	25	250	45
BF370	NPN	TO-92	15	100	500	25
BF450	PNP	TO-92	40	25	250	45
BF451	PNP	TO-92	40	25	250	45
BF494	NPN	TO-92	20	30	300	25
BF495	NPN	TO-92	30	30	300	25
BF496	NPN	TO-92	20	20	300	75
BF926	PNP	TO-92	20	25	250	45
BF970	PNP	SOT37	35	30	160	55
BFR54	NPN	TO-92	15	500 (note 2)	500	25
JF494	NPN	TO-92	20	30	300	25

## Small-signal Transistors

## Selection guide

TYPE	$h_{FE}$	at $I_C$ (mA)	$C_{re}$ typ. (pF)	$f_T$ typ. (MHz)	F typ. (dB)	at f (MHz)	REMARKS	PAGE
BF198	–	–	0.20	400	–	–	gain-controlled TV IF amplifier	261
BF199	–	–	0.34	550	–	–	output video IF amplifier	265
BF240	67 - 220	1	0.34	>150	–	–	AM mixers and IF amplifiers in AM/FM receivers	267
BF241	35 - 125	1	0.34	>150	–	–	AM mixers and IF amplifiers in AM/FM receivers	267
BF324	–	–	0.10 (note 3)	450	3	100	RF stages in FM front-ends	269
BF370	> 40	10	1.6	> 500	–	–	large signal, IF amplifier	275
BF450	62 - 200	1	0.43	>350	–	–	mixer stages in AM receivers and IF stages for AM/FM	291
BF451	30 - 90	1	0.43	>350	–	–	mixer stages in AM receivers and IF stages for AM/FM	291
BF494	67 - 220	1	1	260	–	–	osc., IF amplifier in AM/FM receivers	301
BF495	35 - 125	1	1	120	–	–	FM tuners, IF amplifiers in AM/FM receivers and AM input stages car radios	303
BF496	> 13	2	0.80	> 300	–	–	gain-controlled VHF amplifier	305
BF926	–	–	0.50	350	5	200	mixer/oscillator in VHF/UHF	309
BF970	> 25	3	0.475	900	4.7	800	self-oscillating mixer stage	311
BFR54	> 40	10	–	> 500	–	–	frequency multipliers	313
JF494	67 - 220	1	1	260	–	–		607

## Small-signal Transistors

## Selection guide

## SWITCHING APPLICATIONS

TYPE	POLARITY	CASE	$V_{CE0}$ ( $V_{CER}$ ) (V)	$I_C$ (mA)	$P_{tot}$ (mW)	at $T_{amb}$ ( $T_{case}$ ) (°C)
BCX58	NPN	TO-92	32	200	450	25
BCX59	NPN	TO-92	45	200	450	25
BCX78	PNP	TO-92	32	200	450	25
BCX79	PNP	TO-92	45	200	450	25
BCY58	NPN	TO-18	32	200	330	45
BCY59	NPN	TO-18	45	200	330	45
BCY65	NPN	TO-18	60	200	330	45
BCY70	PNP	TO-18	40	200	350	25
BCY71	PNP	TO-18	45	200	350	25
BCY72	PNP	TO-18	25	200	350	25
BCY78	PNP	TO-18	32	200	345	45
BCY79	PNP	TO-18	45	200	345	45
BFT44	PNP	TO-39	300	500	500	(50)
BFT45	PNP	TO-39	250	500	500	(50)
BFX29	PNP	TO-39	60	600	600	25
BFX30	PNP	TO-39	65	600	600	25
BFX34	NPN	TO-39	60	2000	5000	(25)
BFX84	NPN	TO-39	60	1000	800	25
BFX85	NPN	TO-39	60	1000	800	25
BFX87	PNP	TO-39	50	600	600	25
BFX88	PNP	TO-39	40	600	600	25
BFY50	NPN	TO-39	35	1000	800	25
BFY51	NPN	TO-39	30	1000	800	25
BFY52	NPN	TO-39	20	1000	800	25
BFY55	NPN	TO-39	35	1000	800	25
BSR50	NPN	TO-92	(45)	1000	800	25
BSR51	NPN	TO-92	(60)	1000	800	25
BSR52	NPN	TO-92	(80)	1000	800	25
BSR60	PNP	TO-92	(45)	1000	800	25
BSR61	PNP	TO-92	(60)	1000	800	25
BSR62	PNP	TO-92	(80)	1000	800	25
BSS38	NPN	TO-92	100	100	500	25
BSS50	NPN	TO-39	(45)	1000	5000	(25)
BSS51	NPN	TO-39	(60)	1000	5000	(25)
BSS52	NPN	TO-39	(80)	1000	5000	(25)

## Small-signal Transistors

## Selection guide

TYPE	$h_{FE}$	at $I_C$ (mA)	$f_T$ typ. (MHz)	$t_{off}$ max. (ns)	at $I_C$ (mA)	REMARKS	PAGE
BCX58	-	-	> 125	-	-		203
BCX59	-	-	> 125	-	-		203
BCX78	-	-	> 200	-	-		207
BCX79	-	-	> 200	-	-		207
BCY58	80 - 1000	10	> 150	800	10		215
BCY59	80 - 1000	10	> 150	800	10		215
BCY65	200 - 330	2	$\geq$ 125	800	10		225
BCY70	> 100	10	250	500	10		229
BCY71	> 100	10	250	-	-	BCY71 is low-noise version	229
BCY72	> 100	10	250	500	10		229
BCY78	80 - 1000	10	180	800	10	amplifying and switching	245
BCY79	80 - 1000	10	180	800	10	amplifying and switching	245
BFT44	50 - 150	10	70	125	500		321
BFT45	50 - 150	10	70	125	500		321
BFX29	> 50	10	> 100	150	-		329
BFX30	50 - 200	10	-	290	-		329
BFX34	40 - 150	2000	> 70	1200	5000	inverter and switching regulators	355
BFX84	> 30	150	> 50	360	-		361
BFX85	> 70	150	> 50	360	-		361
BFX87	> 40	10	> 100	150	-		381
BFX88	> 40	10	> 100	150	-		381
BFY50	typ. 112	150	> 60	360	150	general purpose	395
BFY51	typ. 123	150	> 50	360	150	general purpose	395
BFY52	typ. 142	150	> 50	360	150	general purpose	395
BFY55	40 - 120	150	> 60	-	-		415
BSR50	> 2000	500	-	1500	500	Darlington transistor	449
BSR51	> 2000	500	-	1500	500	Darlington transistor	449
BSR52	> 2000	500	-	1500	500	Darlington transistor	449
BSR60	> 2000	500	-	1500	500	Darlington transistor	455
BSR61	> 2000	500	-	1500	500	Darlington transistor	455
BSR62	> 2000	500	-	1500	500	Darlington transistor	455
BSS38	> 20	4	> 60	1000	15	driver for numerical indicator tube	461
BSS50	> 2000	500	-	1000	500	Darlington transistor	465
BSS51	> 2000	500	-	1000	500	Darlington transistor	465
BSS52	> 2000	500	-	1000	500	Darlington transistor	465

## Small-signal Transistors

## Selection guide

## SWITCHING APPLICATIONS (Continued)

TYPE	POLARITY	CASE	$V_{CE0}$ ( $V_{CER}$ ) (V)	$I_C$ (mA)	$P_{tot}$ (mW)	at $T_{amb}$ ( $T_{case}$ ) (°C)
BSS60	PNP	TO-39	(45)	1000	5000	(25)
BSS61	PNP	TO-39	(60)	1000	5000	(25)
BSS62	PNP	TO-39	(80)	1000	5000	(25)
BSS68	PNP	TO-92	100	100	500	25
BSV15	PNP	TO-39	40	1000	5000	(25)
BSV16	PNP	TO-39	60	1000	5000	(25)
BSV17	PNP	TO-39	80	1000	5000	(25)
BSV64	NPN	TO-39	60	2000	5000	(50)
BSW66A	NPN	TO-39	100	1000	5000	(25)
BSW67A	NPN	TO-39	120	1000	5000	(25)
BSW68A	NPN	TO-39	150	1000	5000	(25)
BSX20	NPN	TO-18	15	500 (note 2)	360	25
BSX32	NPN	TO-39	40	1000	800	25
BSX45	NPN	TO-39	40	1000	6250	(25)
BSX46	NPN	TO-39	60	1000	6250	(25)
BSX47	NPN	TO-39	80	1000	6250	(25)
BSX49	NPN	TO-18	40	600	1000	45
BSX59	NPN	TO-39	45	1000	800	25
BSX60	NPN	TO-39	30	1000	800	25
BSX61	NPN	TO-39	45	1000	800	25
BSX62	NPN	TO-39	40	3000	875	25
BSX63	NPN	TO-39	60	3000	875	25
BSY95A	NPN	TO-18	15	200	300	25
MPS3904	NPN	TO-92	40	200	500	25
MPS3906	PNP	TO-92	40	200	500	25
MPSA13	NPN	TO-92	30	500	625	25
MPSA14	NPN	TO-92	30	500	625	25
MPSA25	NPN	TO-92	40	500	500	25
MPSA26	NPN	TO-92	50	500	500	25
MPSA27	NPN	TO-92	60	500	500	25
MPSA42	NPN	TO-92	300	500	625	25
MPSA43	NPN	TO-92	200	500	625	25
MPSA63	PNP	TO-92	30	500	625	25
MPSA64	PNP	TO-92	30	500	625	25



## Small-signal Transistors

## Selection guide

TYPE	$h_{FE}$	at $I_C$ (mA)	$f_T$ typ. (MHz)	$t_{off}$ max. (ns)	at $I_C$ (mA)	REMARKS	PAGE
BSS60	> 2000	500	–	1500	500	Darlington transistor	473
BSS61	> 2000	500	–	1500	500	Darlington transistor	473
BSS62	> 2000	500	–	1500	500	Darlington transistor	473
BSS68	> 30	25	> 50	–	–	general purpose	481
BSV15	63 - 250	100	> 50	650	100	general purpose	485
BSV16	63 - 250	100	> 50	650	100	general purpose	485
BSV17	63 - 250	100	> 50	650	100	general purpose	485
BSV64	> 40	2000	100	1200	5000	high-current characteristics	495
BSW66A	> 30	500	130	900	500	general purpose	501
BSW67A	> 30	500	130	900	500	general purpose	501
BSW68A	> 30	500	130	900	500	general purpose	501
BSX20	40 - 120	10	> 500	18	–	high-speed saturated switching and HF amplifier applications	509
BSX32	30 - 60	10	> 300	60	500		525
BSX45	40 - 250	100	> 50	850	100	general purpose	529
BSX46	40 - 250	100	> 50	850	100	general purpose	529
BSX47	40 - 250	100	> 50	850	100	general purpose	529
BSX49	25 - 40	100	400	50	150	general purpose	541
BSX59	30 - 90	500	> 250	60	500	very high speed core-driving purposes	545
BSX60	30 - 90	500	> 250	70	500	very high speed core-driving purposes	545
BSX61	30 - 90	500	> 250	100	500	very high speed core-driving purposes	545
BSX62	63 - 160	1000	70	1500	100		557
BSX63	100 - 250	1000	70	1500	100		557
BSY95A	50 - 200	10	200	–	–		565
MPS3904	100 - 300	10	> 180	90	10		613
MPS3906	100 - 300	10	> 150	90	10		617
MPSA13	> 5000	10	> 125	–	–	Darlington transistor	635
MPSA14	> 10 000	10	> 125	–	–	Darlington transistor	635
MPSA25	> 10 000	–	220	–	–		637
MPSA26	> 10 000	–	220	–	–		637
MPSA27	> 10 000	–	220	–	–		637
MPSA42	> 40	30	> 50	–	–	high voltage, HF	639
MPSA43	> 40	30	> 50	–	–	high voltage, HF	639
MPSA63	> 5000	10	> 125	–	–	Darlington transistor	643
MPSA64	> 10 000	10	> 125	–	–	Darlington transistor	643

## Small-signal Transistors

## Selection guide

## SWITCHING APPLICATIONS (Continued)

TYPE	POLARITY	CASE	$V_{CE0}$ ( $V_{CER}$ ) (V)	$I_C$ (mA)	$P_{tot}$ (mW)	at $T_{amb}$ ( $T_{case}$ ) (°C)
MPSA75	PNP	TO-92	40	500	500	25
MPSA76	PNP	TO-92	50	500	500	25
MPSA77	PNP	TO-92	60	500	500	25
MPSA92	PNP	TO-92	300	500	625	25
MPSA93	PNP	TO-92	200	500	625	25
PH2222	NPN	TO-92	30	800	625	25
PH2222A	NPN	TO-92	40	800	625	25
PH2369	NPN	TO-92	15	(500)	500	25
PH2907	PNP	TO-92	40	600	625	25
PH2907A	PNP	TO-92	60	600	625	25
PH5415	PNP	TO-92	200	1000	625	25
PH5416	PNP	TO-92	300	1000	625	25
PN2222	NPN	TO-92	30	600	625	25
PN2222A	NPN	TO-92	40	600	625	25
PN2369	NPN	TO-92	15	600	625	25
PN2369A	NPN	TO-92	15	600	625	25
PN2907	PNP	TO-92	40	600	625	25
PN2907A	PNP	TO-92	60	600	625	25
PN3439	NPN	TO-92	350	1000	625	25
PN3440	NPN	TO-92	250	1000	625	25
PN5415	PNP	TO-92	200	1000	625	25
PN5416	PNP	TO-92	300	1000	625	25
2N1613	NPN	TO-39	(50)	500 (note 2)	800	25
2N1711	NPN	TO-39	(50)	1000 (note 2)	800	25
2N1893	NPN	TO-39	80	500	3000	(25)
2N2219	NPN	TO-39	30	800	800	25
2N2219A	NPN	TO-39	40	800	800	25
2N2222	NPN	TO-18	30	800	500	25
2N2222A	NPN	TO-18	40	800	500	25
2N2297	NPN	TO-39	35	1000	800	25
2N2369	NPN	TO-18	15	500 (note 2)	360	25
2N2369A	NPN	TO-18	15	200	360	25

## Small-signal Transistors

## Selection guide

TYPE	$h_{FE}$	at $I_C$ (mA)	$f_T$ typ. (MHz)	$t_{off}$ max. (ns)	at $I_C$ (mA)	REMARKS	PAGE
MPSA75	> 10 000	—	220	—	—		645
MPSA76	> 10 000	—	220	—	—		645
MPSA77	> 10 000	—	220	—	—		645
MPSA92	> 25	30	> 50	—	—	high voltage, HF	647
MPSA93	> 25	30	> 50	—	—	high voltage, HF	647
PH2222	> 75	10	> 250	285	150		649
PH2222A	> 75	10	> 300	285	150		649
PH2369	40 - 120	10	> 500	18	10		653
PH2907	100 - 300	150	> 200	100	150		663
PH2907A	100 - 300	150	> 200	100	150		663
PH5415	30 - 150	50	> 15	—	—	high-voltage switching	667
PH5416	30 - 120	50	> 15	—	—	high-voltage switching	667
PN2222	100 - 300	150	> 250	285	150		669
PN2222A	100 - 300	150	> 250	285	150		669
PN2369	40 - 120	10	—	18	10		673
PN2369A	40 - 120	10	—	18	10		673
PN2907	100 - 300	150	> 200	100	150		677
PN2907A	100 - 300	150	> 200	100	150		677
PN3439	> 30	2	> 70	—	—	high voltage	681
PN3440	> 40	20	> 70	—	—	high voltage	681
PN5415	30 - 150	50	> 15	—	—	high-voltage	683
PN5416	30 - 120	50	> 15	—	—	high-voltage	683
2N1613	40 - 120	150	> 60	—	—	DC and high-speed amplifiers	689
2N1711	100 - 300	150	> 70	—	—		697
2N1893	40 - 120	150	> 50	—	—		701
2N2219	100 - 300	150	> 250	285	150	high-speed switching	705
2N2219A	100 - 300	150	> 300	285	150	high-speed switching	705
2N2222	100 - 300	150	250	285	150	high-speed switching	711
2N2222A	100 - 300	150	200	285	150	high-speed switching	711
2N2297	40 - 120	150	> 60	—	—		717
2N2369	40 - 120	10	> 500	18	10	very high speed saturated switching	721
2N2369A	> 40	10	> 500	18	10	very high speed saturated switching	725

## Small-signal Transistors

## Selection guide

## SWITCHING APPLICATIONS (Continued)

TYPE	POLARITY	CASE	$V_{CE0}$ ( $V_{CER}$ ) (V)	$I_C$ (mA)	$P_{tot}$ (mW)	at $T_{amb}$ ( $T_{case}$ ) (°C)
2N2894A	PNP	TO-18	12	200	1200	15
2N2904	PNP	TO-39	40	600	600	25
2N2904A	PNP	TO-39	60	600	600	25
2N2905	PNP	TO-39	40	600	600	25
2N2905A	PNP	TO-39	60	600	600	25
2N2906	PNP	TO-18	40	600	400	25
2N2906A	PNP	TO-18	60	600	400	25
2N2907	PNP	TO-18	40	600	400	25
2N2907A	PNP	TO-18	60	600	400	25
2N3019	NPN	TO-39	80	1000	800	25
2N3020	NPN	TO-39	80	1000	800	25
2N3053	NPN	TO-39	40	700	5000	(25)
2N3439	NPN	TO-39	400	1000	625	25
2N3440	NPN	TO-39	300	1000	625	25
2N3904	NPN	TO-92	40	200	350	25
2N3906	PNP	TO-92	40	200	350	25
2N4030	PNP	TO-39	60	1000	800	25
2N4031	PNP	TO-39	80	1000	800	25
2N4032	PNP	TO-39	60	1000	800	25
2N4033	PNP	TO-39	80	1000	800	25
2N4036	PNP	TO-39	90	1000	7000	25
2N5400	PNP	TO-92	120	600	625	25
2N5401	PNP	TO-92	150	600	625	25
2N5415	PNP	TO-39	200	1000	1000	50
2N5416	PNP	TO-39	300	1000	1000	50
2N5550	NPN	TO-92	140	60	625	25
2N5551	NPN	TO-92	160	60	625	25

## Small-signal Transistors

## Selection guide

TYPE	$h_{FE}$	at $I_C$ (mA)	$f_T$ typ. (MHz)	$t_{off}$ max. (ns)	at $I_C$ (mA)	REMARKS	PAGE
2N2894A	40 - 150	30	800	35	30		737
2N2904	40 - 120	150	> 200	100	150	high speed switching and driver applications	743
2N2904A	40 - 120	150	> 200	100	150	high speed switching and driver applications	743
2N2905	100 - 300	150	> 200	100	150	high speed switching and driver applications	751
2N2905A	100 - 300	150	> 200	100	150	high speed switching and driver applications	751
2N2906	40 - 120	150	> 200	100	150	high speed switching and driver applications	755
2N2906A	40 - 120	150	> 200	100	150	high speed switching and driver applications	755
2N2907	100 - 300	150	> 200	100	150	high speed switching and driver applications	759
2N2907A	100 - 300	150	> 200	100	150	high speed switching and driver applications	759
2N3019	100 - 300	150	> 100	-	-	amplifiers and medium speed switching	763
2N3020	40 - 120	150	> 80	-	-	amplifiers and medium speed switching	763
2N3053	50 - 250	150	> 100	-	-	medium speed switching	767
2N3439	> 30	2	> 70	-	-		769
2N3440	> 40	20	> 70	-	-		769
2N3904	100 - 300	10	> 300	250	10	high speed saturated switching	771
2N3906	100 - 300	10	> 250	300	10		775
2N4030	> 25	500	> 100	400	500	large signal, low noise, low power	779
2N4031	> 25	500	> 100	400	500	large signal, low noise, low power	779
2N4032	> 70	500	> 100	400	500	large signal, low noise, low power	779
2N4033	> 70	500	> 100	400	500	large signal, low noise, low power	779
2N4036	20 - 200	150	-	700	-		783
2N5400	> 40	10	> 100	-	-	high voltage switching	803
2N5401	> 60	10	> 100	-	-	high voltage switching	803
2N5415	30 - 150	50	> 15	(note 4)	50	high voltage general purpose amplifier applications	807
2N5416	30 - 120	50	> 15	(note 4)	50	high voltage general purpose amplifier applications	807
2N5550	> 60	10	> 100	-	-	high voltage switching	811
2N5551	> 80	10	> 100	-	-	high voltage switching	811

## Small-signal Transistors

## Selection guide

## HIGH VOLTAGE APPLICATIONS

TYPE	POLARITY	CASE	$V_{CE0}$ ( $V_{CER}$ ) (V)	$I_C$ (mA)	$P_{tot}$ (mW)	at $T_{amb}$ (°C)
BF420	NPN	TO-92	(300)	50	830	25
BF421	PNP	TO-92	(300)	50	830	25
BF422	NPN	TO-92	250	50	830	25
BF423	PNP	TO-92	250	50	830	25
BF483	NPN	TO-92	250	100	830	25
BF485	NPN	TO-92	300	100	830	25
BF487	NPN	TO-92	350	100	830	25
BF484	PNP	TO-92	250	100	830	25
BF486	PNP	TO-92	300	100	830	25
BF488	PNP	TO-92	350	100	830	25
MPSA42	PNP	TO-92	300	500	625	25
MPSA43	PNP	TO-92	200	500	625	25
MPSA92	PNP	TO-92	300	500	625	25
MPSA93	PNP	TO-92	200	500	625	25
PH5415	PNP	TO-92	200	1000	625	25
PH5416	PNP	TO-92	300	1000	625	25
PN3439	NPN	TO-92	350	1000	625	25
PN3440	NPN	TO-92	250	1000	625	25
PN5415	NPN	TO-92	200	1000	625	25
PN5416	PNP	TO-92	200	1000	625	25
2N3439	NPN	TO-92	400	1000	625	25
2N3440	NPN	TO-92	400	1000	625	25
2N5400	PNP	TO-92	120	600	625	25
2N5401	PNP	TO-92	150	600	625	25
2N5415	PNP	TO-39	200	1000	1000	50
2N5416	PNP	TO-39	300	1000	1000	50
2N5550	NPN	TO-92	140	60	625	25
2N5551	NPN	TO-92	160	60	625	25

TYPE	$h_{FE}$	at $I_C$ (mA)	$C_{re}$ (pF)	$f_T$ (MHz)	REMARKS	PAGE
BF420	> 50	25	1.0	> 60	class-B video output	279
BF421	> 50	25	1.1	> 60	class-B video output	285
BF422	> 50	25	1.0	> 60	class-B video output	279
BF423	> 50	25	1.1	> 60	class-B video output	285
BF483	> 50	25	1.4	> 70	video output	293
BF485	> 50	25	1.4	> 70	video output	293
BF487	> 50	25	1.4	> 70	video output	293
BF484	> 50	25	1.6	> 70		297
BF486	> 50	25	1.6	> 70		297
BF488	> 50	25	1.6	> 70		297
MPSA42	> 40	30	–	> 50	high voltage switching	639
MPSA43	> 40	30	–	> 50	high voltage switching	639
MPSA92	> 25	30	–	> 50	high voltage switching	647
MPSA93	> 25	30	–	> 50	high voltage switching	647
PH5415	30 - 150	50	–	> 15	high voltage switching	667
PH5416	30 - 120	50	–	> 15	high voltage switching	667
PN3439	> 30	2	–	> 70		681
PN3440	> 40	20	–	> 70		681
PN5415	30 - 150	50	–	> 15		683
PN5416	30 - 120	50	–	> 15		683
2N3439	> 30	2	–	> 70		769
2N3440	> 40	20	–	> 70		769
2N5400	> 40	10	–	> 100	high voltage switching	803
2N5401	> 60	10	–	> 100	high voltage switching	803
2N5415	30 - 150	50	–	> 15	high voltage, general purpose and amplifier	807
2N5416	30 - 120	50	–	> 15	high voltage, general purpose and amplifier	807
2N5550	> 60	10	–	> 100	high voltage switching	811
2N5551	> 80	10	–	> 100	high voltage switching	811

## PNPN DEVICES

## Programmable unijunction transistors

TYPE	CASE	$V_{GA}$ (V)	$I_A$ (mA)	$I_{ARM}$ (A)	$di_A/dt$ (A/ $\mu$ s)	$I_p$ max. ( $\mu$ A)
BRY39	TO-72	70	175	2.5	20	5
BRY56	TO-92	70	175	2.5	20	5

## Silicon controlled switches

TYPE	CASE	$V_{CBO}$ (V)	$I_E$ (mA)	$I_{ERM}$ (A)	$P_{tot}$ (mW)	at $T_{amb}$ (°C)	$V_{AK}$ max. (V)
BR101	TO-72	50	175	2.5	275	25	1.4
BRY39	TO-72	70	175	2.5	275	25	1.4

## Notes

1. Dual transistors for differential amplifiers.
2.  $I_{CM}$ .
3.  $C_{br}$ .
4. Typical value.



## Small-signal Transistors

## Selection guide

TYPE	$I_V$ min. ( $\mu\text{A}$ )	$t_r$ max. (ns)	REMARKS	PAGE
BRY39	25	80	characteristics measured with $R_G = 10 \text{ k}\Omega$	431
BRY56	2	80	characteristics measured with $R_G = 10 \text{ k}\Omega$	445

TYPE	$I_H$ max. (mA)	$t_{on}$ max. ( $\mu\text{s}$ )	$t_q$ max. ( $\mu\text{s}$ )	REMARKS	PAGE
BR101	1.0	—	—	characteristics measured with $R_G = 10 \text{ k}\Omega$	427
BRY39	1.0	1.5	8	characteristics measured with $R_G = 10 \text{ k}\Omega$	437



## CONVERSION LIST

**Small-signal Transistors**

**Conversion List**

**CONVERSION LIST FROM LEADED TO SMD TYPE**

LEADED	SMD
BC107	BC847
BC107A	BC847A
BC107B	BC847B
BC108	BC848
BC108A	BC848A
BC108B	BC848B
BC109	BC849
BC109B	BC849B
BC109C	BC849C
BC177	BC857
BC177A	BC857A
BC177B	BC857B
BC178	BC858
BC178A	BC858A
BC178B	BC858B
BC179	BC859
BC179A	BC859A
BC179B	BC859B
BC200/01	BC859B
BC200/02	BC859B/C
BC200/03	BC859C
BC327	BC807
BC327-16	BC807-16
BC327-25	BC807-25
BC327-40	BC807-40
BC328	BC808
BC328-16	BC808-16
BC328-25	BC808-25
BC328-40	BC808-40
BC337	BC817
BC337-16	BC817-16
BC337-25	BC817-25
BC337-40	BC817-40
BC338	BC818
BC338-16	BC818-16
BC338-25	BC818-25
BC338-40	BC818-40
BC368	BC868

LEADED	SMD
BC369	BC869
BC516	BCV26
BC517	BCV27
BC546	BC846
BC546A	BC846A
BC546B	BC846B
BC547	BC847
BC547A	BC847A
BC547B	BC847B
BC547C	BC847C
BC548	BC848
BC548A	BC848A
BC548B	BC848B
BC548C	BC848C
BC549	BC849
BC549B	BC849B
BC549C	BC849C
BC550	BC850
BC550B	BC850B
BC550C	BC850C
BC556	BC856
BC556A	BC856A
BC556B	BC856B
BC557	BC857
BC557A	BC857A
BC557B	BC857B
BC557C	BC857C
BC558	BC858
BC558A	BC858A
BC558A	BCW29
BC558B	BC858B
BC558C	BC858C
BC559	BC859
BC559A	BC859A
BC559B	BC859B
BC559C	BC859C
BC560	BC860
BC560A	BC860A

Small-signal Transistors

Conversion List

LEADED	SMD
BC560B	BC860B
BC560C	BC860C
BC635	BCX54
	BCP54
BC635-10	BCX54-10
	BCP54-10
BC635-16	BCX54-16
	BCP54-16
BC636	BCX51
	BCP51
BC636-10	BCX51-10
	BCP51-10
BC636-16	BCX51-16
	BCP51-16
BC637	BCX55
	BCP55
BC637-10	BCX55-10
	BCP55-10
BC637-16	BCX55-16
	BCP55-16
BC638	BCX52
	BCP52
BC638-10	BCX52-10
	BCP52-10
BC638-16	BCX52-16
	BCP52-16
BC639	BCX56
	BCP56
BC639-10	BCX56-10
	BCP56-10
BC639-16	BCX56-16
	BCP56-16
BC640	BCX53
	BCP53
BC640-10	BCX53-10
	BCP53-10
BC640-16	BCX53-16
	BCP53-16

LEADED	SMD
BCX58	BCW60
BCX59	BCX70
BCX78	BCW61
BCX79	BCX71
BCY56	BC850B
BCY57	BC849
BCY58	BC849
	BCW60 family
BCY58-VII	BCW60A
BCY58-VIII	BCW60B
BCY58-IX	BCW60C
BCY58-X	BCW60D
BCY59	BCX70 fam.
BCY59-VII	BCX70G
BCY59-VIII	BCX70H
BCY59-IX	BCX70J
BCY59-X	BCX70K
BCY65	BCV71
	BCV72
BCY70	BCF70
BCY71	BCF70
BCY72	BCF29/30
BCY78	BCW61 fam.
BCY78-VII	BCW16A
BCY78-VIII	BCW61B
BCY78-IX	BCW61C
BCY78-X	BCW61D
BCY79	BCX71 fam.
BCY79-VII	BCX71G
BCY79-VIII	BCX71H
BCY79-IX	BCX71J
BD135	BCX54
	BCP54
BD135-10	BCX54-10
	BCP54-10
BD135-16	BCX54-16
	BCP54-16

Small-signal Transistors

Conversion List

LEADED	SMD
BD136	BCX51
	BCP54
BD136-10	BCX51-10
	BCP51-10
BD136-16	BCX51-16
	BCP51-16
BD137	BCX55
	BCP55
BD137-10	BCX55-10
	BCP55-10
BD137-16	BCX55-16
	BCP55-16
BD138	BCX52
	BCP52
BD138-10	BCX52-10
	BCP52-10
BD138-16	BCX52-16
	BCP52-16
BD139	BCX56
	BCP56
BD139-10	BCX56-10
	BCP56-10
BD139-16	BCX56-16
	BCP56-16
BD140	BCX53
	BCP53
BD140-10	BCX53-10
	BCP53-10
BD140-16	BCX53-16
	BCP53-16
BDX42	BST50
	BSP50
BDX43	BST51
	BSP51
BDX44	BST52
	BSP52
BDX45	BST60
	BSP60

LEADED	SMD
BDX46	BST61
	BSP61
BDX47	BST61
	BSP61
BF199	BFS20
BF240	BF840
BF241	BF841
BF324	BF824
BF370	BF570
BF410A	BF510
BF410B	BF511
BF410C	BF512
BF410D	BF513
BF419	BST40
	BSP20
BF420	BF620
	BF720
	BF820
BF421	BF621
	BF721
	BF821
BF422	BF622
	BF722
	BF822
BF423	BF623
	BF723
	BF823
BF450	BF550
BF451	BF550
BF457	BST40
BF458	BST40
BF459	BST39
BF469	BF622
	BF722
BF470	BF623
	BF723
BF471	BF620
	BF720

## Small-signal Transistors

## Conversion List

LEADED	SMD	LEADED	SMD
BF472	BF621	BF982	BF992
	BF721	BFG65	BFG67
BF483	BF722	BFQ23	BFT93
BF484	BF723	BFQ24	BFT93
BF485	BF720	BFQ34	BFQ18A
BF486	BF721		BFG35
BF494	BFS19	BFQ34T	BFQ18A
BF494B	BFS19		BFG35
BF495	BFS18	BFQ51	BFT92
BF459C	BFS18	BFQ52	BFT92
BF459D	BFS18	BFQ65	BFQ67
BF606A	BF660	BFR54	BSV52
BF819	BST40	BFR90	BFR92A
	BSP20	BFR91	BFR93A
BF857	BST40	BFR96	BFQ19
	BSP20		BFG27
BF858	BST40	BFR96S	BFQ19
	BSP20		BFG27
BF859	BST39	BFT24	BFT25
BF869	BF622	BFT44	BST16
	BF722		BSP16
BF870	BF623	BFT45	BST15/16
	BF723		BSP15/16
BF871	BF620	BFW11	BFR30
	BF720	BFW12	BFR31
BF872	BF621	BFW13	BFT46
	BF721	BFW16A	BFQ17
BF926	BF660	BFW30	BFR53
BF960	BF989	BFW92	BFS17
BF964	BF994	BFW93	BFR53
	BF994S	BFX29	BSR16
BF966	BF996	BFX30	BSR16
	BF996S	BFX84	BSR40
BF970	BF569		BSP40
BF970A	BF569	BFX85	BSR41
BF979	BF579		BSP41
BF980	BF990	BFX86	BSR41
BF981	BF991		BSP41

## Small-signal Transistors

## Conversion List

LEADED	SMD	LEADED	SMD
BFX87	BSR16	BSS68	BSS63
BFX88	BSR15	BSV15	BSR30/31
BFY50	BSR40		BSP30/31
	BSP40	BSV15-6	BSR30
BFY51	BSR40		BSP30
	BSP40	BSV15-10	BSR30/31
BFY52	BSR40		BSP30/31
	BSP40	BSV15-16	BSR31
BFY55	BSR40		BSP31
	BSP40	BSV16	BSR30/31
BFY90	BFS17		BSP30/31
BR101	BRY62	BSV16-6	BSR30
BRY39	BRY62		BSP30
BRY56	BRY61	BSV16-10	BSR30/31
BSR50	BST50		BSP30/31
	BSP50	BSV16-16	BSR31
BSR51	BST51		BSP31
	BSP51	BSV17	BSR32/33
BSR52	BST52		BSP32/33
	BSP52	BSV17-6	BSR32
BSR60	BST60		BSP32
	BSP60	BSV17-10	BSR32/33
BSR61	BST61		BSP32/33
	BSP61	BSX20	BSV52
BSR62	BST62		PMBT2369
	BSP62	BSX45	BSR40/41
BSS38	BSS64		BSP40/41
BSS50	BST50	BSX45-6	BSR40
	BSP50		BSP40
BSS51	BST51	BSX45-10	BSR40/41
	BSP51		BSP40/41
BSS52	BST52	BSX45-16	BSR41
	BSP52		BSP41
BSS60	BST60	BSX46	BSR40/41
	BSP60		BSP40/41
BSS61	BST61	BSX46/6	BSR40
	BSP61		BSP40
BSS62	BST62	BSX46-10	BSR40/41
	BSP62	BSX46-16	BSR41



## Small-signal Transistors

## Conversion List

LEADED	SMD
BSX47	BSR42/43
BSX47-6	BSR42
BSX47-10	BSR42-43
BSY95A	BSV52
MPS6513	BC848A
MPS6514	BC848A
MPS6515	BC848B
MPS6517	BC858A
MPS6518	BC858A
MPS6519	BC858B
MPS6520	BC859B
MPS6521	BC859C
MPS6522	BC859B
MPS6523	BC859C
MPSA05	PMBTA05
MPSA06	PMBTA06
MPSA13	PMBTA13
MPSA14	PMBTA14
MPSA42	PMBTA42
MPSA43	PMBTA43
MPSA55	PMBTA55
MPSA56	PMBTA56
MPSA63	PMBTA63
MPSA64	PMPTA64
MPSA92	PMBTA92
MPSA93	PMBTA93
PH2222	PMBT2222
PH2222A	PMBT2222A
PH2369	PMBT2369
PH2907	PMBT2907
PH2907A	PMBT2907A
PN2222	PMBT2222
PN2222A	PMBT2222A
PN2369	PMBT2369
PN2369A	PMBT2369A
PN2907	PMBT2907
PM2907A	PMBT2907A

LEADED	SMD
PN3439	BST39
	BSP19
PN3440	BST40
	BSP20
PN5415	BST15
	BSP15
PN5416	BST16
	BSP16
2N2894A	BSR12
2N929	BC850
2N930	BC850
2N1613	BSR40
2N1711	BSR41
2N1893	BSR42
2N2219	PMBT2222
2N2219A	PMBT2222A
2N2222	PMBT2222
2N2222A	PMBT2222A
2N2297	BSR40
2N2369	PMBT2369
2N2369A	PMBT2369A
2N2483	BC850B
2N2484	BC850B/C
2N2905	PMBT2907
2N2905A	PMBT2907A
2N2907	PMBT2907
2N2907A	PMBT2907A
2N3019	BSR43
	BSP43
2N3020	BSR42
	BSP42
2N3053	BSR40/41
	BSP40/41
2N3904	PMBT3904
2N3906	PMBT3906
2N4030	BSR30
2N4031	BSR32

## Small-signal Transistors

## Conversion List

LEADED	SMD
2N4032	BSR31
2N4033	BSR33
2N4124	PMBS3904
2N4126	PMBS3906
2N4400	PMBT4400
2N4401	PMBT4401
2N4402	PMBT4402
2N4403	PMBT4403
2N5086	PMBT5086
2N5087	PMBT5087
2N5088	PMBT5088
2N5415	BST15 BSP15
2N5416	BST16 BSP16
2N6428	PMBT6428
2N6429	PMBT6429

## **GENERAL**

**Type designation**

**Rating systems**

**Letter symbols**

**SOAR curves**

**Soldering recommendations  
for SOT37 and SOT103 envelopes**

**TO-92  
variant transistors on tape**



## PRO ELECTRON TYPE DESIGNATION CODE FOR SEMICONDUCTOR DEVICES

This type designation code applies to discrete semiconductor devices – as opposed to integrated circuits –, multiples of such devices and semiconductor chips.

“Although not all type numbers accord with the Pro Electron system, the following explanation is given for the ones that do.”

A basic type number consists of:

*TWO LETTERS FOLLOWED BY A SERIAL NUMBER*

### FIRST LETTER

The first letter gives information about the material used for the active part of the devices.

- A. GERMANIUM or other material with band gap of 0,6 to 1,0 eV.
- B. SILICON or other material with band gap of 1,0 to 1,3 eV.
- C. GALLIUM-ARSENIDE or other material with band gap of 1,3 eV or more.
- R. COMPOUND MATERIALS (e.g. Cadmium-Sulphide).

### SECOND LETTER

The second letter indicates the function for which the device is primarily designed.

- A. DIODE; signal, low power
- B. DIODE; variable capacitance
- C. TRANSISTOR; low power, audio frequency ( $R_{th\ j-mb} > 15\ K/W$ )
- D. TRANSISTOR; power, audio frequency ( $R_{th\ j-mb} \leq 15\ K/W$ )
- E. DIODE; tunnel
- F. TRANSISTOR; low power, high frequency ( $R_{th\ j-mb} > 15\ K/W$ )
- G. MULTIPLE OF DISSIMILAR DEVICES – MISCELLANEOUS; e.g. oscillator
- H. DIODE; magnetic sensitive
- L. TRANSISTOR; power, high frequency ( $R_{th\ j-mb} \leq 15\ K/W$ )
- N. PHOTO-COUPLER
- P. RADIATION DETECTOR; e.g. high sensitivity phototransistor
- Q. RADIATION GENERATOR; e.g. light-emitting diode (LED)
- R. CONTROL AND SWITCHING DEVICE; e.g. thyristor, low power ( $R_{th\ j-mb} > 15\ K/W$ )
- S. TRANSISTOR; low power, switching ( $R_{th\ j-mb} > 15\ K/W$ )
- T. CONTROL AND SWITCHING DEVICE; e.g. thyristor, power ( $R_{th\ j-mb} \leq 15\ K/W$ )
- U. TRANSISTOR; power, switching ( $R_{th\ j-mb} \leq 15\ K/W$ )
- X. DIODE: multiplier, e.g. varactor, step recovery
- Y. DIODE; rectifying, booster
- Z. DIODE; voltage reference or regulator (transient suppressor diode, with third letter W)

# TYPE DESIGNATION

## SERIAL NUMBER

Three figures, running from 100 to 999, for devices primarily intended for consumer equipment.\*  
One letter (Z, Y, X, etc.) and two figures, running from 10 to 99, for devices primarily intended for industrial/professional equipment.\*  
This letter has no fixed meaning except W, which is used for transient suppressor diodes.

## VERSION LETTER

It indicates a minor variant of the basic type either electrically or mechanically. The letter never has a fixed meaning, except letter R, indicating reverse voltage, e.g. collector to case or anode to stud.

## SUFFIX

Sub-classification can be used for devices supplied in a wide range of variants called associated types. Following sub-coding suffixes are in use:

### 1. VOLTAGE REFERENCE and VOLTAGE REGULATOR DIODES: *ONE LETTER and ONE NUMBER*

The LETTER indicates the nominal tolerance of the Zener (regulation, working or reference) voltage

- A. 1% (according to IEC 63: series E96)
- B. 2% (according to IEC 63: series E48)
- C. 5% (according to IEC 63: series E24)
- D. 10% (according to IEC 63: series E12)
- E. 20% (according to IEC 63: series E6)

The number denotes the typical operating (Zener) voltage related to the nominal current rating for the whole range.

The letter 'V' is used instead of the decimal point.

### 2. TRANSIENT SUPPRESSOR DIODES: *ONE NUMBER*

The NUMBER indicates the maximum recommended continuous reversed (stand-off) voltage  $V_R$ . The letter 'V' is used as above.

### 3. CONVENTIONAL and CONTROLLED AVALANCHE RECTIFIER DIODES and THYRISTORS: *ONE NUMBER*

The NUMBER indicates the rated maximum repetitive peak reverse voltage ( $V_{RRM}$ ) or the rated repetitive peak off-state voltage ( $V_{DRM}$ ), whichever is the lower. Reversed polarity is indicated by letter R, immediately after the number.

### 4. RADIATION DETECTORS: *ONE NUMBER*, preceded by a hyphen (-)

The NUMBER indicates the depletion layer in  $\mu\text{m}$ . The resolution is indicated by a version LETTER.

### 5. ARRAY OF RADIATION DETECTORS and GENERATORS: *ONE NUMBER*, preceded by a stroke (/).

The NUMBER indicates how many basic devices are assembled into the array.

\* When these serial numbers are exhausted the serial number for consumer types may be extended to four figures, and that for industrial types to three figures.

## RATING SYSTEMS

The rating systems described are those recommended by the International Electrotechnical Commission (IEC) in its Publication 134.

### DEFINITIONS OF TERMS USED

*Electronic device.* An electronic tube or valve, transistor or other semiconductor device.

Note

This definition excludes inductors, capacitors, resistors and similar components.

*Characteristic.* A characteristic is an inherent and measurable property of a device. Such a property may be electrical, mechanical, thermal, hydraulic, electro-magnetic, or nuclear, and can be expressed as a value for stated or recognized conditions. A characteristic may also be a set of related values, usually shown in graphical form.

*Bogey electronic device.* An electronic device whose characteristics have the published nominal values for the type. A bogey electronic device for any particular application can be obtained by considering only those characteristics which are directly related to the application.

*Rating.* A value which establishes either a limiting capability or a limiting condition for an electronic device. It is determined for specified values of environment and operation, and may be stated in any suitable terms.

Note

Limiting conditions may be either maxima or minima.

*Rating system.* The set of principles upon which ratings are established and which determine their interpretation.

Note

The rating system indicates the division of responsibility between the device manufacturer and the circuit designer, with the object of ensuring that the working conditions do not exceed the ratings.

### ABSOLUTE MAXIMUM RATING SYSTEM

Absolute maximum ratings are limiting values of operating and environmental conditions applicable to any electronic device of a specified type as defined by its published data, which should not be exceeded under the worst probable conditions.

These values are chosen by the device manufacturer to provide acceptable serviceability of the device, taking no responsibility for equipment variations, environmental variations, and the effects of changes in operating conditions due to variations in the characteristics of the device under consideration and of all other electronic devices in the equipment.

The equipment manufacturer should design so that, initially and throughout life, no absolute maximum value for the intended service is exceeded with any device under the worst probable operating conditions with respect to supply voltage variation, equipment component variation, equipment control adjustment, load variations, signal variation, environmental conditions, and variations in characteristics of the device under consideration and of all other electronic devices in the equipment.

## DESIGN MAXIMUM RATING SYSTEM

Design maximum ratings are limiting values of operating and environmental conditions applicable to a bogey electronic device of a specified type as defined by its published data, and should not be exceeded under the worst probable conditions.

These values are chosen by the device manufacturer to provide acceptable serviceability of the device, taking responsibility for the effects of changes in operating conditions due to variations in the characteristics of the electronic device under consideration.

The equipment manufacturer should design so that, initially and throughout life, no design maximum value for the intended service is exceeded with a bogey device under the worst probable operating conditions with respect to supply voltage variation, equipment component variation, variation in characteristics of all other devices in the equipment, equipment control adjustment, load variation, signal variation and environmental conditions.

## DESIGN CENTRE RATING SYSTEM

Design centre ratings are limiting values of operating and environmental conditions applicable to a bogey electronic device of a specified type as defined by its published data, and should not be exceeded under normal conditions.

These values are chosen by the device manufacturer to provide acceptable serviceability of the device in average applications, taking responsibility for normal changes in operating conditions due to rated supply voltage variation, equipment component variation, equipment control adjustment, load variation, signal variation, environmental conditions, and variations in the characteristics of all electronic devices.

The equipment manufacturer should design so that, initially, no design centre value for the intended service is exceeded with a bogey electronic device in equipment operating at the stated normal supply voltage.



## LETTER SYMBOLS FOR TRANSISTORS AND SIGNAL DIODES

based on IEC Publication 148

## LETTER SYMBOLS FOR CURRENTS, VOLTAGES AND POWERS

**Basic letters**

The basic letters to be used are:

I, i = current  
 V, v = voltage  
 P, p = power.

Lower-case basic letters shall be used for the representation of instantaneous values which vary with time.

In all other instances upper-case basic letters shall be used.

**Subscripts**

A, a	Anode terminal
(AV), (av)	Average value
B, b	Base terminal, for MOS devices; Substrate
(BR)	Breakdown
C, c	Collector terminal
D, d	Drain terminal
E, e	Emitter terminal
F, f	Forward
G, g	Gate terminal
K, k	Cathode terminal
M, m	Peak value
O, o	As third subscript: The terminal not mentioned is open circuited
R, r	As first subscript: Reverse. As second subscript: Repetitive. As third subscript: With a specified resistance between the terminal not mentioned and the reference terminal.
(RMS), (rms)	Root-mean-square value
S, s	{ As first or second subscript: Source terminal (for FETS only) As second subscript: Non-repetitive (not for FETS) As third subscript: Short circuit between the terminal not mentioned and the reference terminal
X, x	Specified circuit
Z, z	Replaces R to indicate the actual working voltage, current or power of voltage reference and voltage regulator diodes.

Note: No additional subscript is used for DC values.

Upper-case subscripts shall be used for the indication of:

- a) continuous (DC) values (without signal)  
Example  $I_B$
- b) instantaneous total values  
Example  $i_B$
- c) average total values  
Example  $I_{B(AV)}$
- d) peak total values  
Example  $I_{BM}$
- e) root-mean-square total values  
Example  $I_{B(RMS)}$

Lower-case subscripts shall be used for the indication of values applying to the varying component alone :

- a) instantaneous values  
Example  $i_b$
- b) root-mean-square values  
Example  $I_{b(rms)}$
- c) peak values  
Example  $I_{bm}$
- d) average values  
Example  $I_{b(av)}$

Note: If more than one subscript is used, subscript for which both styles exist shall either be all upper-case or all lower-case.

## **Additional rules for subscripts**

### Subscripts for currents

Transistors: If it is necessary to indicate the terminal carrying the current, this should be done by the first subscript (conventional current flow from the external circuit into the terminal is positive).

Examples:  $I_B$ ,  $i_B$ ,  $i_b$ ,  $I_{bm}$

Diodes: To indicate a forward current (conventional current flow into the anode terminal) the subscript F or f should be used; for a reverse current (conventional current flow out of the anode terminal) the subscript R or r should be used.

Examples:  $I_F$ ,  $I_R$ ,  $i_F$ ,  $I_{f(rms)}$

Subscripts for voltages

Transistors: If it is necessary to indicate the points between which a voltage is measured, this should be done by the first two subscripts. The first subscript indicates the terminal at which the voltage is measured and the second the reference terminal or the circuit node. Where there is no possibility of confusion, the second subscript may be omitted.

Examples:  $V_{BE}$ ,  $v_{BE}$ ,  $v_{be}$ ,  $V_{bem}$

Diodes: To indicate a forward voltage (anode positive with respect to cathode), the subscript F or f should be used; for a reverse voltage (anode negative with respect to cathode) the subscript R or r should be used.

Examples:  $V_F$ ,  $V_R$ ,  $v_F$ ,  $V_{rm}$

Subscripts for supply voltages or supply currents

Supply voltages or supply currents shall be indicated by repeating the appropriate terminal subscript.

Examples:  $V_{CC}$ ,  $I_{EE}$

Note: If it is necessary to indicate a reference terminal, this should be done by a third subscript

Example:  $V_{CCE}$

Subscripts for devices having more than one terminal of the same kind

If a device has more than one terminal of the same kind, the subscript is formed by the appropriate letter for the terminal followed by a number; in the case of multiple subscripts, hyphens may be necessary to avoid misunderstanding.

Examples:  $I_{B2}$  = continuous (DC) current flowing into the second base terminal

$V_{B2-E}$  = continuous (DC) voltage between the terminals of second base and emitter

Subscripts for multiple devices

For multiple unit devices, the subscripts are modified by a number preceding the letter subscript; in the case of multiple subscripts, hyphens may be necessary to avoid misunderstanding.

Examples:  $I_{2C}$  = continuous (DC) current flowing into the collector terminal of the second unit

$V_{1C-2C}$  = continuous (DC) voltage between the collector terminals of the first and the second unit.

## Application of the rules

The figure below represents a transistor collector current as a function of time. It consists of a continuous (DC) current and a varying component.

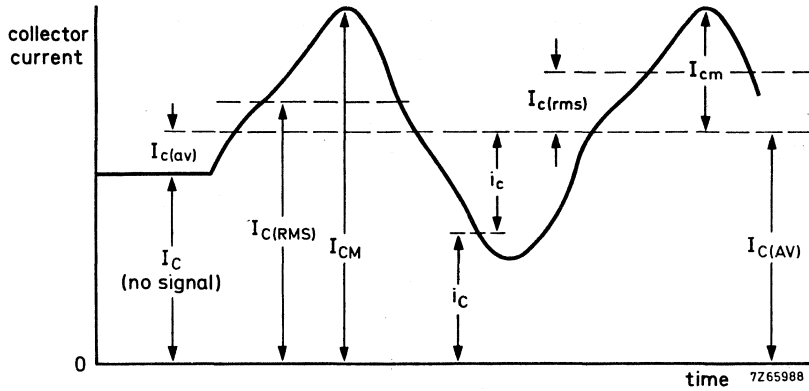

## LETTER SYMBOLS FOR ELECTRICAL PARAMETERS

### Definition

For the purpose of this Publication, the term "electrical parameter" applies to four-pole matrix parameters, elements of electrical equivalent circuits, electrical impedances and admittances, inductances and capacitances.

### Basic letters

The following is a list of the most important basic letters used for electrical parameters of semiconductor devices.

- B, b = susceptance; imaginary part of an admittance
- C = capacitance
- G, g = conductance; real part of an admittance
- H, h = hybrid parameter
- L = inductance
- R, r = resistance; real part of an impedance
- X, x = reactance; imaginary part of an impedance
- Y, y = admittance;
- Z, z = impedance;

Upper-case letters shall be used for the representation of:

- a) electrical parameters of external circuits and of circuits in which the device forms only a part;
- b) all inductances and capacitances.

Lower-case letters shall be used for the representation of electrical parameters inherent in the device (with the exception of inductances and capacitances).

### Subscripts

#### General subscripts

The following is a list of the most important general subscripts used for electrical parameters of semiconductor devices:

F, f	= forward; forward transfer
I, i (or 1)	= input
L, l	= load
O, o (or 2)	= output
R, r	= reverse; reverse transfer
S, s	= source

Examples:  $Z_S$ ,  $h_I$ ,  $h_F$

The upper-case variant of a subscript shall be used for the designation of static (d. c.) values.

Examples :  $h_{FE}$  = static value of forward current transfer ratio in common-emitter configuration (DC current gain)

$R_E$  = DC value of the external emitter resistance

Note: The static value is the slope of the line from the origin to the operating point on the appropriate characteristic curve, i. e. the quotient of the appropriate electrical quantities at the operating point.

The lower-case variant of a subscript shall be used for the designation of small-signal values.

Examples:  $h_{fe}$  = small-signal value of the short-circuit forward current transfer ratio in common-emitter configuration

$Z_e = R_e + jX_e$  = small-signal value of the external impedance

Note: If more than one subscript is used, subscripts for which both styles exist shall either be all upper-case or all lower-case

Examples:  $h_{FE}$ ,  $y_{RE}$ ,  $h_{fe}$

## Subscripts for four-pole matrix parameters

The first letter subscript (or double numeric subscript) indicates input, output, forward transfer or reverse transfer

Examples:  $h_i$  (or  $h_{11}$ )  
 $h_o$  (or  $h_{22}$ )  
 $h_f$  (or  $h_{21}$ )  
 $h_r$  (or  $h_{12}$ )

A further subscript is used for the identification of the circuit configuration. When no confusion is possible, this further subscript may be omitted.

Examples:  $h_{fe}$  (or  $h_{21e}$ ),  $h_{FE}$  (or  $h_{21E}$ )

### **Distinction between real and imaginary parts**

If it is necessary to distinguish between real and imaginary parts of electrical parameters, no additional subscripts should be used. If basic symbols for the real and imaginary parts exist, these may be used.

Examples:  $Z_i = R_i + jX_i$   
 $y_{fe} = g_{fe} + jb_{fe}$

If such symbols do not exist or if they are not suitable, the following notation shall be used:

Examples:  $\text{Re}(h_{ib})$  etc. for the real part of  $h_{ib}$   
 $\text{Im}(h_{ib})$  etc. for the imaginary part of  $h_{ib}$

## TRANSISTOR SAFE OPERATING AREA

If a power transistor is to give reliable service, four operating limits must be observed:

- Maximum collector current.
- Maximum collector-emitter voltage.
- Maximum power dissipation.
- Second breakdown limit.

These limits are all specified in the data sheets; the purpose here is to enable designers to make the best use of that information.

### Collector current

Maximum collector current  $I_{Cmax}$  is specified in the data sheets for d.c. operation. For pulsed operation a higher collector current  $I_{Cmax}$  is permitted, for a defined maximum pulse length (max. 20 ms) and duty factor (usually 0,01).

For power switching transistors  $I_{Csat}$  is given; this is the value at which switching times and saturation voltage is measured.

### Collector-emitter voltage

Maximum collector-emitter voltage  $V_{CEO}$  is also specified in the data sheets, but no extension is allowed for pulsed operation. In the case of power transistors specifically designed for switching inductive loads some extension may be allowed, but then only under specified conditions of collector current, base-emitter voltage and emitter-base resistance as stated in the relevant data sheets.

### Power dissipation

Maximum power dissipation  $P_{tot max}$  is specified in the data sheets for a given mounting base temperature. This is usually 25 °C but may be any, much higher temperature.  $P_{tot max}$  applies up to the stated temperature; above it derating must be applied. A power derating curve of the form shown in Fig. 1a and 1b is given in the data sheets. With it, maximum allowable power dissipation can be calculated for any mounting base temperature up to  $T_{j max}$ .

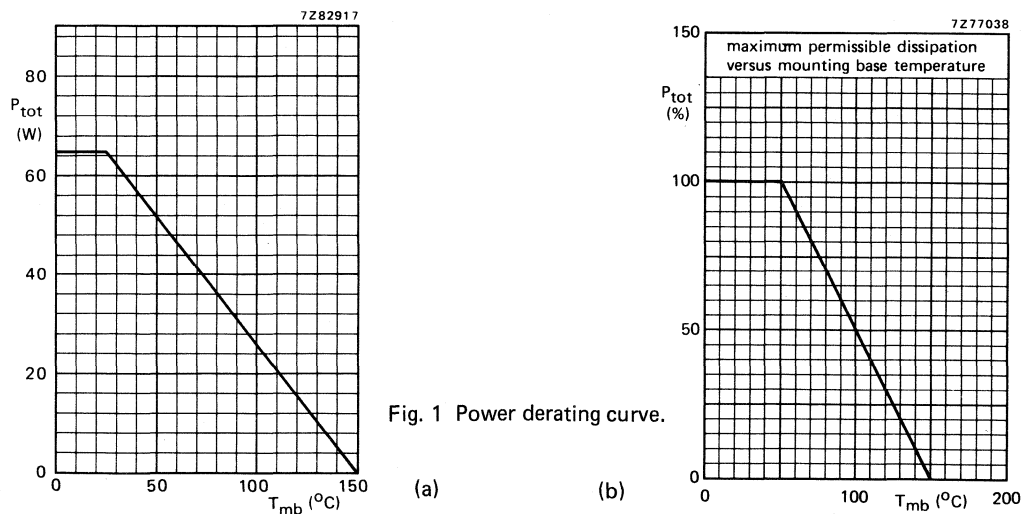

Fig. 1 Power derating curve.

Total power dissipation is given by

$$P_{tot} = I_C V_{CE} + I_B V_{BE}.$$

The second term can usually be disregarded, so  $P_{tot} \approx I_C V_{CE}$ .

Heat dissipated in the collector-base junction flows through the thermal resistance between junction and mounting base, see Fig. 2.

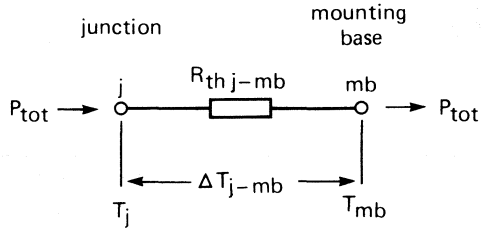

7Z89359

Fig. 2 Heat transport in a transistor with power dissipation constant with respect to time.

By analogy with Ohm's law, under steady-state conditions (d.c. operation).

For pulsed operation a higher dissipation is permitted, because

- the junction does not have time to heat up fully unless the pulses are so long as to approximate steady-state conditions;
- the junction has time wholly or partly to cool down in the interval between pulses, except with very high duty factors.

Analogy with

$$P_{tot} = \frac{T_j - T_{mb}}{R_{th\ j-mb}}$$

yields

$$P_{tot\ M} = \frac{T_j - T_{mb}}{Z_{th\ j-mb}}$$

where  $P_{tot\ M}$  is the total pulsed power and  $Z_{th\ j-mb}$  is the thermal impedance between junction and mounting base. Thermal impedance depends on pulse duration  $t_p$  and duty factor  $\delta = t_p/T$ .  $T$  is the pulse period. A family of curves of thermal impedance against pulse duration with duty factor as parameter is shown in Fig. 3.



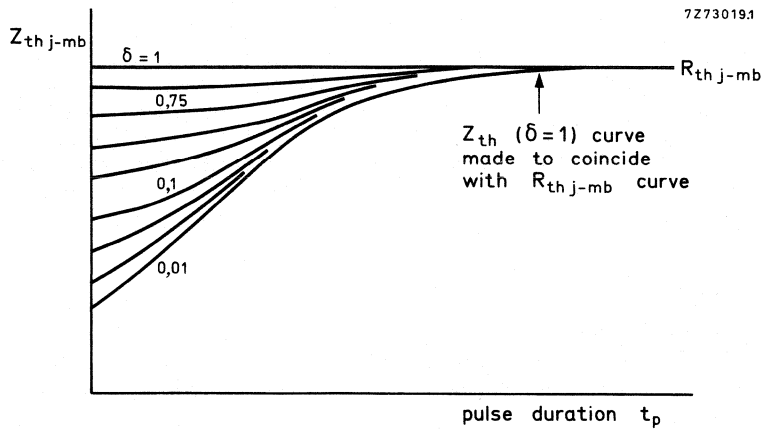

Fig. 3 A typical family of  $Z_{th\ j-mb}$  curves for a power transistor.

In essence, at or below  $T_{mb\ spec}$  there is a fixed limit to  $P_{tot\ M\ max}$ ; above  $T_{mb\ spec}$ ,  $P_{tot\ M\ max}$  declines linearly with increasing mounting base temperature. As illustrated in Fig. 4, for non-rectangular pulses

$$P_{tot\ max} \cdot t_p = \int_{t_1}^{t_2} P \cdot t_p$$

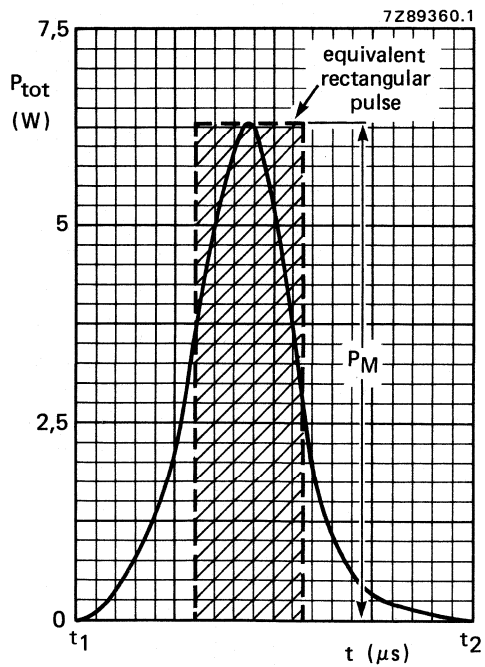

Fig. 4.

### Second breakdown

In the forward-biased condition second breakdown is thermally triggered. Consider the chip as a large number of elemental transistors in parallel, some of which will have a lower forward voltage drop than others. Current will tend to concentrate in these, raising their temperature and further lowering their forward voltage drop. Current will concentrate still further, leading to local overheating and eventually to a short circuit between emitter and collector. This effect is dependent of mounting base temperature, which is related to the average junction temperature. Under reverse-bias conditions, when  $V_{CE}$  is greater than  $V_{CE0max}$ , the chance of second breakdown is always present. This is a particular hazard in timebase and converter applications.

### THE SOAR BOUNDARIES

The four limits just described form the boundaries of the Safe Operating Area. Figure 5 shows a SOAR plotted on a log-log grid. The right-hand boundary is formed by  $V_{CE0max}$ , which extends up to a collector current of about 300 mA. Above this point, as  $I_C$  is increased  $V_{CE}$  must be reduced to prevent second breakdown.

The upper boundary is formed by  $I_{Cmax}$ , which extends to where the product of  $I_{Cmax}$  and  $V_{CE}$  equals the maximum allowable power dissipation. From this point  $I_C$  must be reduced with increasing  $V_{CE}$ , thus forming the maximum power dissipation boundary. The maximum power dissipation boundary normally intersects the second breakdown boundary at some point. However, for values of  $T_{mb}$  above  $T_{mb\ spec}$ ,  $P_{tot\ max}$  must be reduced (as shown by the broken line in Fig. 5), so that the boundary of maximum power dissipation intersects the second breakdown boundary at a lower point. With high values of  $T_{mb}$ , the second breakdown boundary may be excluded altogether.

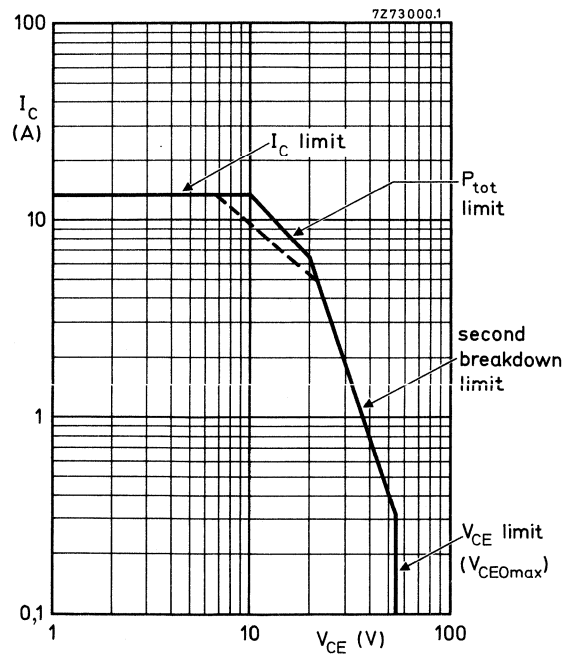

Fig. 5 A typical SOAR graph with boundaries named.

**EXTENDING THE SOAR FOR SINGLE-SHOT AND REPETITIVE PULSED OPERATION**

The data sheets for power transistors contain, apart from the d.c. SOAR, a set of curves that apply under specific pulse conditions. These will cover some 90% of applications. In addition to these, SOAR curves can be constructed by the circuit designer for specific operating conditions. The various extensions dealt with below will refer to Figs 5, 6 and 7.

**$I_{CMmax}$**

The extent to which the  $I_C$  boundary can be extended for pulse operation depends on pulse duration and duty factor, the limit being  $I_{CMmax}$ , which applies at a duty factor of 0.01 and a pulse length of 20 ms or less. Together the  $I_{CMmax}$  and  $V_{CE0max}$  boundaries form a rectangle that in no circumstance should be exceeded. Moreover, the rectangle may be reduced by further restrictions imposed by power dissipation and second breakdown. The example shown in Fig. 6 is for an  $I_{CMmax}$  of 12 A and a  $V_{CE0max}$  of 60 V.

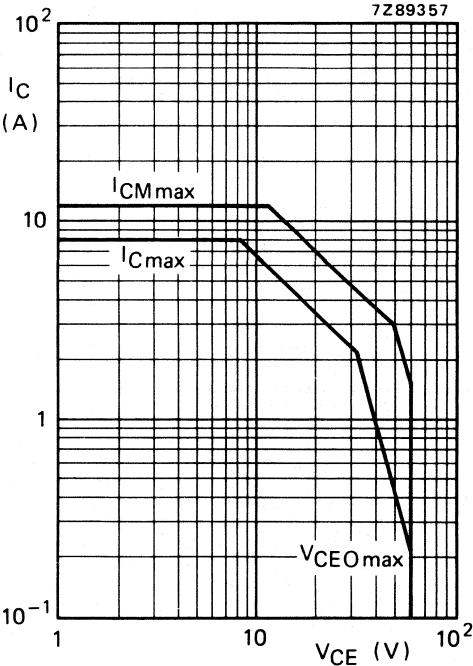

Fig. 6 Maximum collector current and collector-emitter voltage boundaries.

**P<sub>tot max</sub>**

The P<sub>tot max</sub> boundary given in the data sheet usually applies to:

T<sub>mb</sub> = 25 °C; δ = 0,01 and t<sub>p</sub> = a range of values, say, 5 μs to 2 ms.

For any deviations from these values a new P<sub>tot max</sub> boundary must be constructed.

From

$$P_{\text{tot Mmax}} = \frac{T_{j \text{ max}} - T_{\text{mb}}}{Z_{\text{th j-mb}}};$$

T<sub>j max</sub> is stated in the data sheets; Z<sub>th j-mb</sub> can be read from the curve, similar to Fig. 3, also given in the data sheets. Thus P<sub>tot Mmax</sub> can be calculated and an appropriate boundary can be drawn in the SOAR curve parallel to the P<sub>tot max</sub> line. An example will illustrate this. Assume:

T<sub>j max</sub> = 150 °C; T<sub>mb</sub> = 80 °C; t<sub>p</sub> = 0,2 ms and δ = 0,1.

From Fig. 7, Z<sub>th j-mb</sub> = 0,5 K/W for the given values of t<sub>p</sub> and δ.

$$P_{\text{tot Mmax}} = \frac{150 - 80}{0,5} = 140 \text{ W.}$$

Thus from an arbitrary point (say 7 A, 20 V) we can draw a line parallel to the P<sub>tot max</sub> line (see Fig. 6).

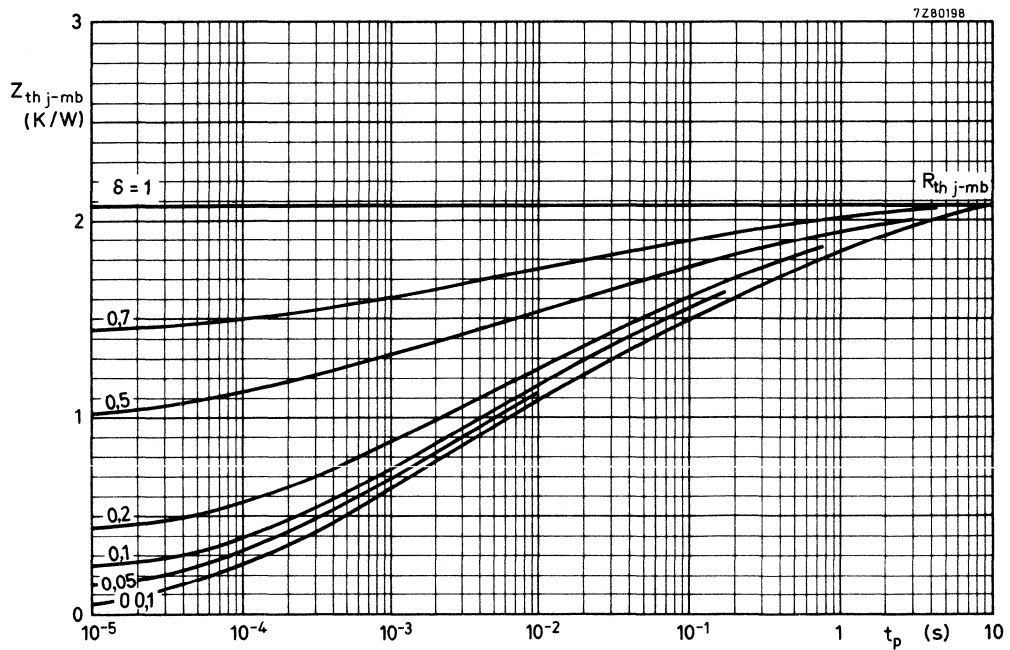

Fig. 7 Transient thermal impedance for example.

### Second breakdown

The permissible extension to the second breakdown boundary is found with the aid of two multiplying factors:

$M_V$  — the voltage multiplying factor

$M_I$  — the current multiplying factors.\*

Curves for these two factors are given in the data sheets as functions of pulse time with duty factor as parameter (see Fig. 8).

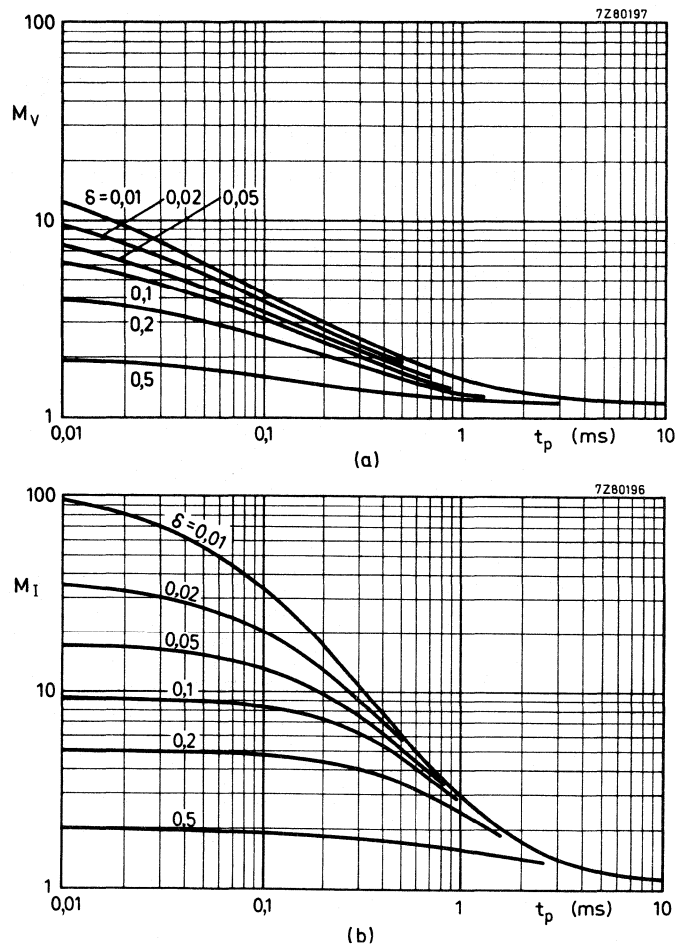

Fig. 8 Second breakdown multiplying factors as a function of pulse time, with duty factor as a parameter.

$M_V$  is used to calculate the point on the  $V_{CE0max}$  boundary at which voltage derating must commence as  $I_C$  increases. Similarly,  $M_I$  is used to calculate the point on the  $I_{CMmax}$  line at which current derating must commence as  $V_{CE}$  increases.

\* Prior to 1973  $M_V$  was known as  $M_{SB(I)}$  and  $M_I$  as  $M_{SB(V)}$ .

Referring to Fig. 9,, where B is the point on the  $V_{CE0max}$  boundary at which voltage derating commences, B' can be calculated by:

$$I_{C(B')} = I_{C(B)} \times M_I.$$

Similarly for  $I_C$ ; although here A, the point on the  $I_C$  curve at which current derating commences, is first determined by extending the second breakdown boundary to where the two would intersect if  $P_{tot max}$  did not intervene. A' is then given by

$$V_{CA(S')} = V_{CE(A)} \times M_V.$$

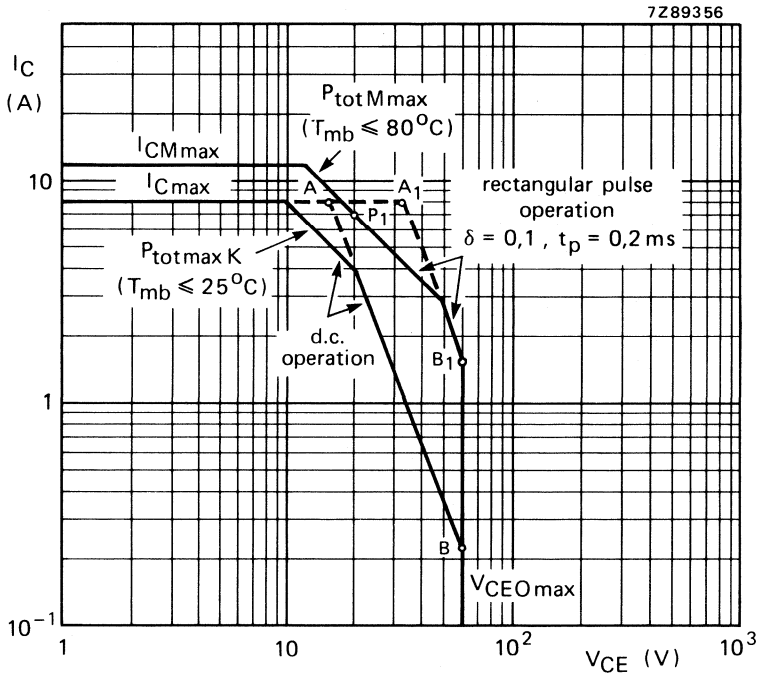

Fig. 9 Construction of the pulse operating area.

An example is worked in Fig. 9 for  $t_p = 0,2$  ms and  $\delta = 0,1$ .

From Fig. 8,  $M_V = 2,4$  and  $M_I = 7,3$ :

$$I_{C(B')} = 0,22 \times 7,3 = 1,6 \text{ A}$$

$$V_{CE(A')} = 13 \times 2,4 = 31 \text{ V.}$$

These two points are then joined as in Fig. 9.

## PULSE TRAINS AND COMPOSITE WAVEFORMS

Straightforward techniques exist for calculating the thermal and second breakdown effects of pulse trains and composite waveforms.

### Thermal considerations

Consider a train of rectangular pulses as shown in Fig. 10. The junction will alternately heat and partly cool until a steady-state temperature is reached as shown in the lower part of Fig. 10. To approximate the final junction temperature only the effects of the first two or three pulses need be considered.

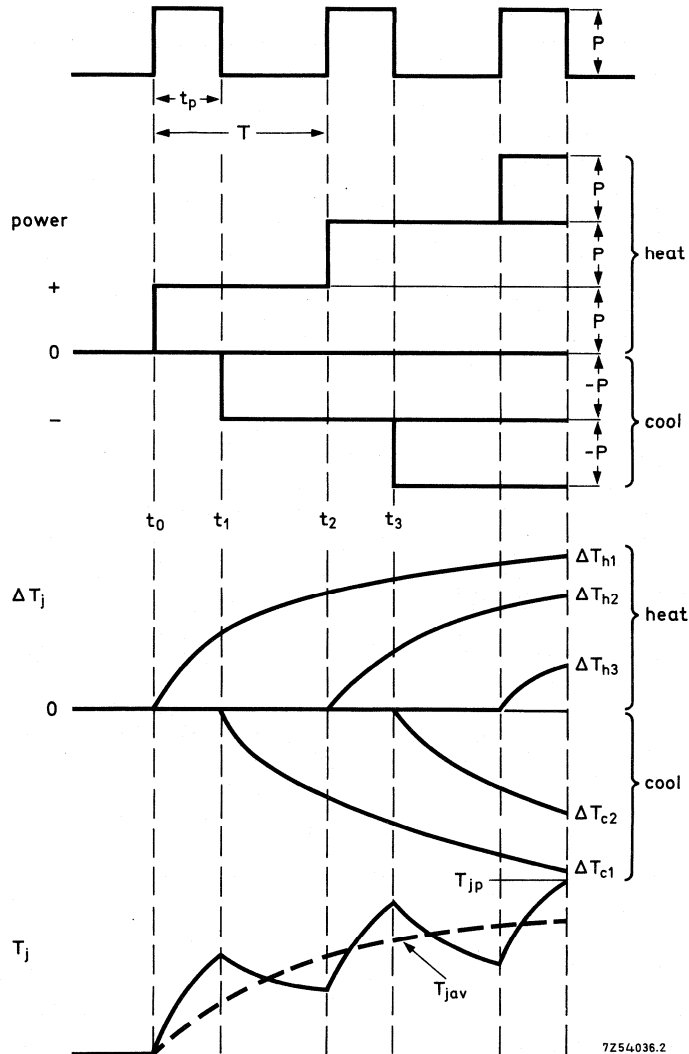

Fig. 10 The heating effect of three equidistant, equal-magnitude pulses.  $T_{j\text{av}}$  is the average junction temperature.  $P = 100\text{ W}$ ,  $t_p = 100\ \mu\text{s}$ ;  $T = 1\ \text{ms}$  and  $\delta = 0,1$ .

Referring to Fig. 10, where  $P = 100 \text{ W}$ ,  $t_p = 100 \mu\text{s}$  and  $\delta = 0,1$ , the first pulse causes the junction to heat up; at the end of the pulse it starts to cool down until the second pulse recommences the heating cycle. We can replace the first pulse with a *continuous* heating pulse at  $t_0$  and a *continuous* cooling pulse starting at  $t_1$ . Similarly for the second pulse, we can superimpose a continuous heating pulse starting at  $t_2$  and a cooling pulse starting at  $t_3$ . Repeating this for successive pulses allows us to calculate  $T_j$  for any point in the pulse train. For instance, the cumulative change in junction temperature at the end of the third pulse is:

$$\Delta T_j = \Delta T_{h1} - \Delta T_{c1} + \Delta T_{h2} - \Delta T_{c2} + \Delta T_{h3}$$

where the subscripts h and c refer to heating and cooling respectively. With times taken from Fig. 10,

$$T_{h1} = PZ_{th}(2,1 \text{ ms})$$

$$T_{h2} = PZ_{th}(1,1 \text{ ms})$$

$$T_{h3} = PZ_{th}(0,1 \text{ ms})$$

and

$$T_{c1} = -PZ_{th}(2,0 \text{ ms})$$

$$T_{c2} = -PZ_{th}(1,0 \text{ ms})$$

Taking values for  $Z_{th}$  from Fig. 11 we get

$$\Delta T_j = 100(0,58 - 0,56 + 0,51 - 0,51 + 0,32) = 34 \text{ }^\circ\text{C}.$$

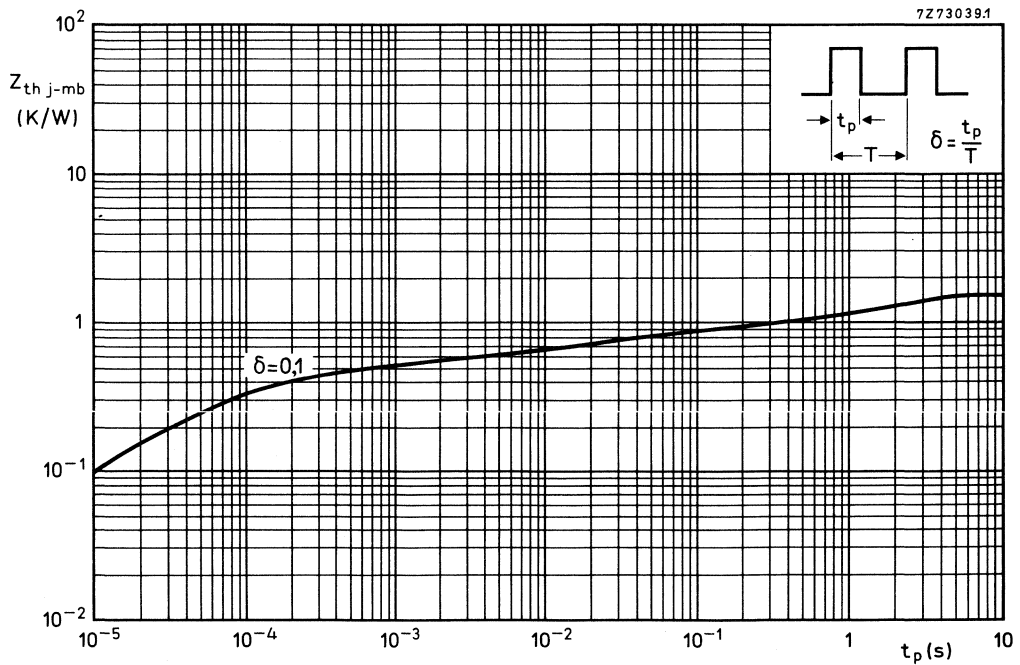

Fig. 11 Curve of  $Z_{th\ j-mb} = f(t_p)$ .



The same procedure can be used for long or continuous pulse trains, but calculating for a large number of pulses is very tedious. A sufficiently close approximation can be made by calculating for two pulses, assuming that the first is preceded by a continuous pulse of  $P_{av}$  as shown in Fig. 12. By this method

$$\Delta T_j = \Delta T_{hav} + \Delta T_{h1} - \Delta T_{c1} + \Delta T_{h2}$$

The calculations are then made as before. To remove any doubt as to the closeness of the approximation the effect of a third pulse can be calculated. Composite waveforms can be treated similarly: divide the composite waveform into equivalent rectangular pulses and calculate the junction temperature accordingly.

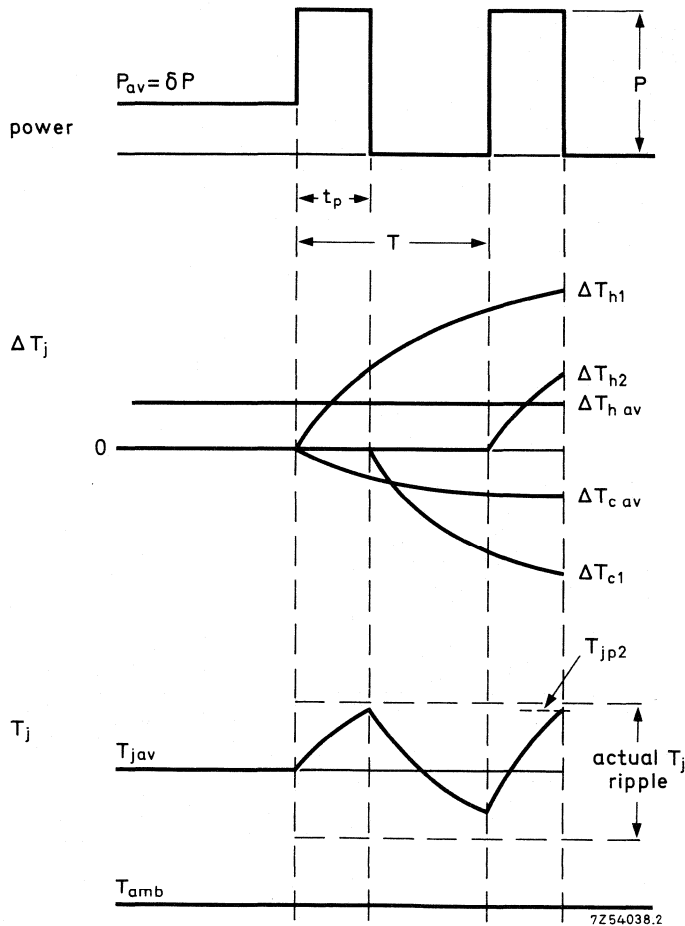

Fig. 12.

Figure 13 shows the current, voltage and power waveforms of the out put transistor in a television receiver vertical output stage.  $P_{tot}$  has been divided into four equivalent rectangular parts having the same peak values and energy content as the original waveform.

$$\begin{aligned}
 P_{\text{tot av}} &= P_1\delta_1 + P_2\delta_2 + P_3\delta_3 + P_4\delta_4 \\
 &= (16 \times 0,003) + (13 \times 0,11) + \\
 &\quad + (5,2 \times 0,66) + (40 \times 0,0007) \\
 &= 4,936 \text{ W.}
 \end{aligned}$$

Assuming that the  $R_{\text{th j-mb}}$  for the transistor is 2,5 K/W, the average rise in mounting base temperature will be about 12,5 °C.

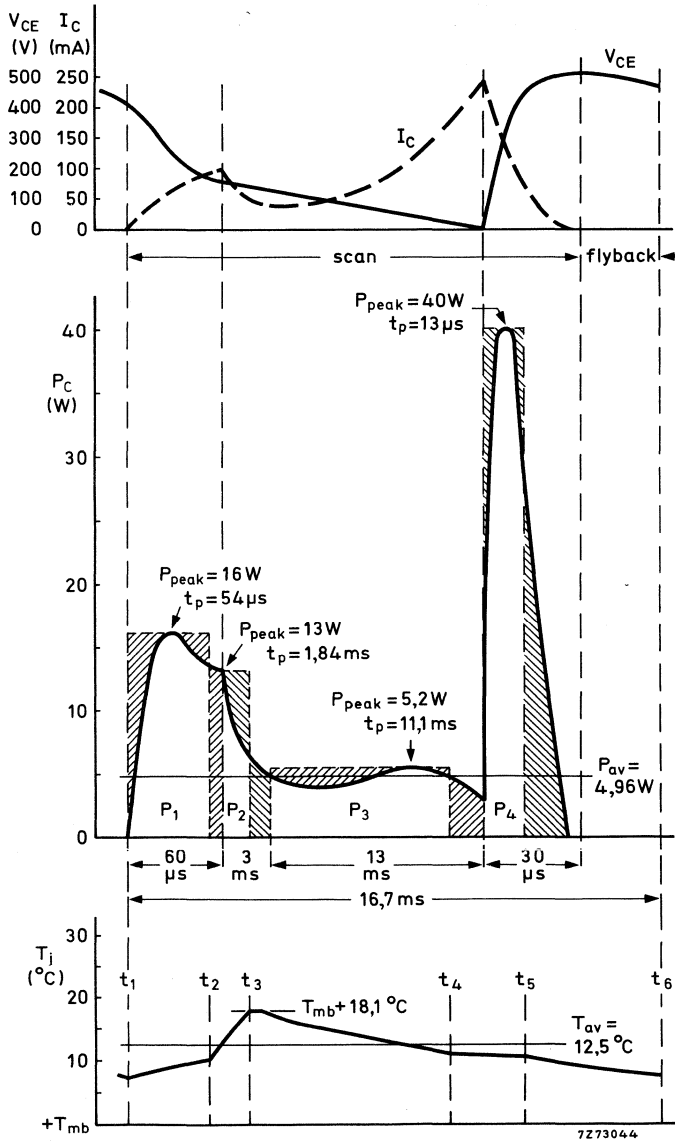

Fig. 13 Power waveforms showing their division into rectangular pulses and the junction temperature variations which they cause.

Using the same method as for pulse trains, peak temperatures at the end of each pulse can be calculated by

$$T_{j-mb}(t_1) = P_{av}R_{th j-mb} - P_{av}Z_{th j-mb}(16,1 \text{ ms}) + P_1Z_{th}(16,1 \text{ ms})$$

For the temperature at the end of the second pulse ( $t_2$ ) two further terms are added:

$$-P_1Z_{th}(16,04 \text{ ms}) + P_2Z_{th}(16,04 \text{ ms})$$

For  $t_3$  yet another two terms:

$$-P_3Z_{th}(13,02 \text{ ms}) + P_4Z_{th}(13,03 \text{ ms})$$

For each successive pulse a negative term (end of the previous pulse) and a positive term (start of the succeeding pulse) are added. Calculated temperatures are shown in Table 1: note that the highest temperature is reached at the end of pulse 2 ( $t_3$ ). Even assuming a  $T_{mb}$  of 100 °C,  $T_j$  will remain within the  $T_{j \text{ max}}$  of 150 °C specified for this transistor.

TABLE 1 Calculated temperatures for the power waveform of Fig. 13.

time	$t_1$	$t_2$	$t_3$	$t_4$	$t_5$	$t_6(t_s)$	°C
$\Delta T_{j-mb}$	8,54	11,34	18,1	12,76	12,3	8,54	

### EXAMPLE OF A SOAR CALCULATION

To illustrate the foregoing we will take the example of a BU426A transistor operating in a 200 W switched-mode power supply (SMPS).

Waveforms of collector current, collector-emitter voltage and power dissipation are shown in Figs 14, 15 and 16. These are translated into an equivalent rectangular pulse train in Fig. 17. This will enable us to calculate peak junction temperature at any instant.

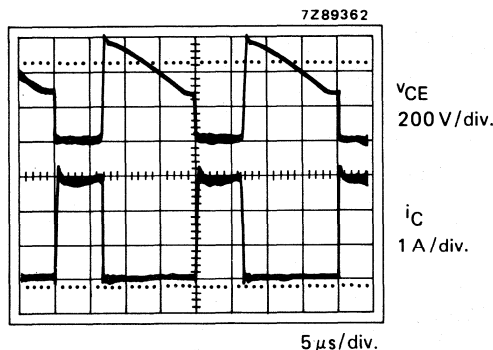

Fig. 14 Collector-current and collector-emitter voltage waveforms of a BU426A transistor in a 200 W SMPS.

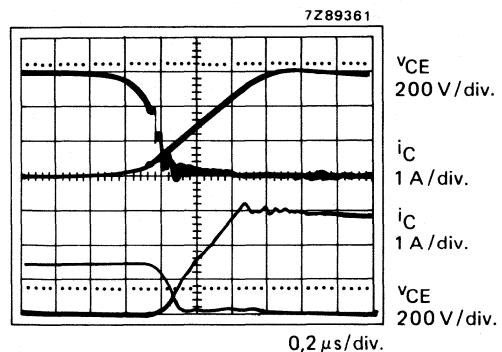

Fig. 15 Waveforms during turn-on and turn-off (lower part).

The duration of this equivalent pulse train is then given by

$$t_p' = \frac{P_{tot\ av} \times T}{P_M} \text{ and } \delta' = \frac{t_p'}{T}$$

First, from Fig. 17, heating and cooling pulses are plotted as in Fig. 18. Parameters are then tabulated as shown:

$P_{turn-on} = 66\text{ W}$	$P_{sat} = 10\text{ W}$	$P_{turn-off} = 56\text{ W}$
$t_{p\ on} = 0,8\ \mu\text{s}$	$t_{p\ sat} = 2,2\ \mu\text{s}$	$t_{p\ off} = 0,6\ \mu\text{s}$
$\delta_{on} = 0,04$	$\delta_{sat} = 0,11$	$\delta_{off} = 0,03$

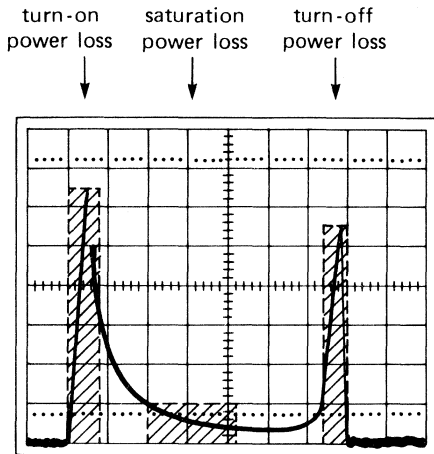

7289363

Fig. 16 Power loss and resultant rectangular power pulses.

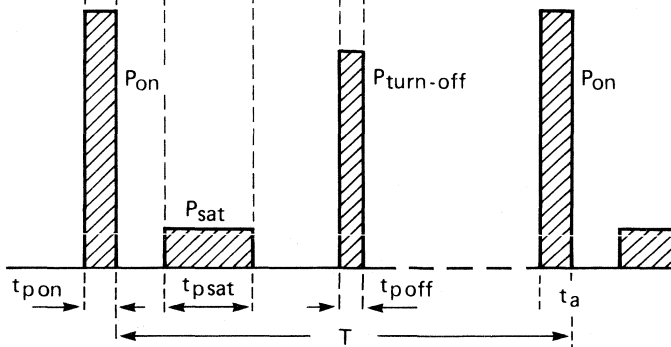

Fig. 17.

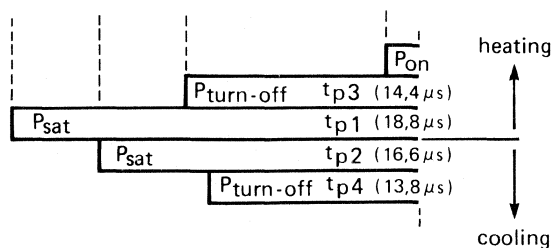

Fig. 18.

From Fig. 17 we can determine  $\delta_p$  and  $t_p$  for each condition and from the BU426 data sheets the relevant  $Z_{th}$ .

	p1	p2	p3	p4	p5	unit
t	18,8	16,6	14,4	13,8	0,8	$\mu s$
$\delta$	0,94	0,83	0,72	0,7	0,04	
$Z_{th}$	1,05	0,95	0,85	0,8	0,06	K/W

From

$$\Delta T_j = \Delta T_{h1} - \Delta T_{c1} + \Delta T_{h2} - \Delta T_{c2} + \Delta T_{h3}$$

$$\Delta T_{j-mb}(t_a) = (P_{sat} \times Z_{th}(tp1)) - (P_{sat} \times Z_{th}(tp2)) + (P_{turn-off} \times Z_{th}(tp3)) - (P_{turn-off} \times Z_{th}(tp4)) + (P_{on} \times Z_{th}(tp_{on}))$$

$$\Delta T_{j-mb}(t_a) = 10(1,05 - 0,95) + 56(0,83 - 0,8) + 66(0,06) = 7,76 \text{ K.}$$

Thus, at time  $t_a$  the peak junction temperature is 7,76 K higher than the average mounting base temperature. The  $\Delta T_{j-mb}$  arising from the other power pulses can be calculated in the same way. Average mounting base temperature depends on the size of the heatsink, ambient temperature ( $T_a$ ) and average dissipation.

From

$$P_{tot\ av} = P_1\delta_1 + P_2\delta_2 + P_3\delta_3 + P_4\delta_4$$

$$P_{tot\ av} = \delta_{on} \times P_{on} + \delta_{sat} \times P_{sat} + \delta_{turn-off} \times P_{off}$$

$$= 0,04 \times 66 + 0,11 \times 10 + 0,03 \times 56 = 5,4 \text{ W.}$$

Assuming a maximum mounting base temperature of 100 °C and an ambient temperature of 60 °C the thermal resistance of the heatsink required will be

$$R_{th\ mb-a} = \frac{T_{mb} - T_a}{P_{tot\ av}} = \frac{100 - 60}{5,4} = 7,4 \text{ K/W.}$$

If this is the case, the peak junction temperature at the end of the turn-on power pulse will be 107,76 °C, which is well within the maximum allowable junction temperature of 150 °C.

The pulse SOAR can be calculated using  $M_I$ ,  $M_V$  and  $Z_{th}$  factors as described earlier. The turn-on, saturation and turn-off power pulses should be combined into a single pulse of amplitude  $P'$  equal to the highest amplitude power pulse (here,  $P_{on}$ ) and duration  $t'_p$ .

$$P_{tot\ av} = P' = 66 \text{ W.}$$

$$\delta' = \frac{5,4}{66} = 0,082.$$

$$t'_p + \delta' T = 1,64 \mu s.$$

From the BU426A data, for this power pulse  $Z_{th\ j-mb} = 0,10 \text{ K/W}$ ;  $M_I \approx 12$ ;  $M_V \approx 7,5$ ;  $V_{CE(A')} = 7,5 \times 12 = 90 \text{ V}$ ;  $I_{C(B')} = 12 \times 40 = 480 \text{ mA}$ ,

$$P_{\text{tot max}} = \frac{T_j - T_{\text{mb}}}{Z_{\text{th j-mb}}} = \frac{150 - 100}{0,1} = 500 \text{ W.}$$

The relevant pulse SOAR is shown in Fig. 19, in which the operating point for the full cycle has also been plotted. It can be seen that it remains well within the SOAR.

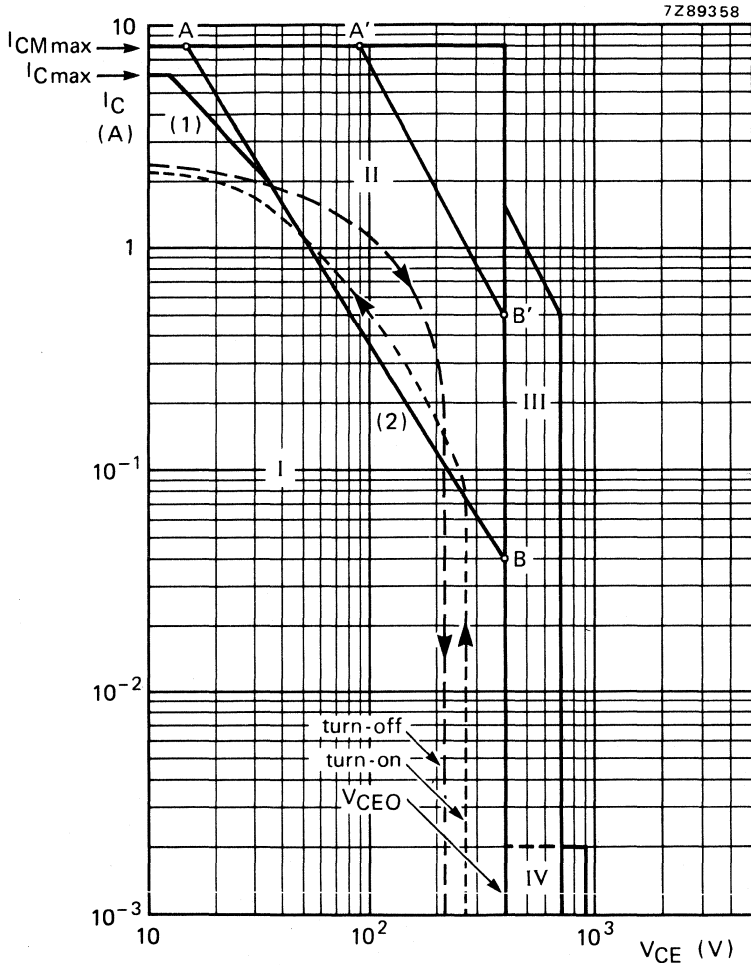

Fig. 19 Safe Operating Area BU426A at  $T_{\text{mb}} \leq 73 \text{ }^\circ\text{C}$ .

- I Region of permissible d.c. operation.
  - II Permissible extension for repetitive pulse operation.
  - III Area of permissible operation during turn-on in single-transistor converters, provided  $R_{\text{BE}} \leq 100 \text{ } \Omega$  and  $t_p \leq 0,6 \text{ } \mu\text{s}$ .
  - IV Repetitive pulse operation in this region is permissible, provided  $V_{\text{BE}} \leq 0$  and  $t_p \leq 2 \text{ ms}$ .
- (1)  $P_{\text{tot max}}$  and  $P_{\text{peak max}}$  lines.  
 (2) Second-breakdown limits (independent of temperature).

## SOLDERING RECOMMENDATIONS SOT-37 AND SOT-103

Transistors in SOT-37 and SOT-103 envelopes may be mounted with leads flat (Fig. 1) or bent (Figs 2 and 3). Different soldering procedures apply for the different styles of mounting.

### FLAT-LEAD MOUNTING

#### Soldering by hand

Avoid putting any force on the leads during or just after soldering.

Solder the three leads one at a time, *not* simultaneously.

Proceed from one lead to the adjacent lead, *not* to the opposite one.

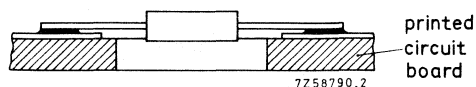

Fig. 1

Solder temperature	max.	300 °C
Soldering time	max.	5 s
Solder-to-case distance	min.	2 mm

### BENT-LEAD MOUNTING

If leads are bent, all three may be soldered simultaneously if desired.

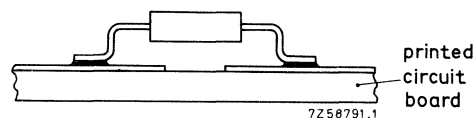

Fig. 2

Solder temperature	max.	300 °C
Soldering time	max.	10 s

### DIP OR WAVE SOLDERING

When dip or wave soldering, the maximum allowable temperature of the solder is 260 °C. This temperature must not be in contact with the joint for more than 5 seconds. The total contact time of successive solder waves must not exceed 5 seconds. The device may be mounted up to the lead projections, but the temperature of the body must not exceed the specified storage maximum.

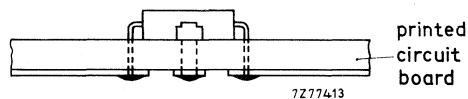

Fig. 3

Solder temperature	max.	260 °C
Soldering time	max.	5 s

TO-92 TRANSISTORS ON TAPE

Mechanical data

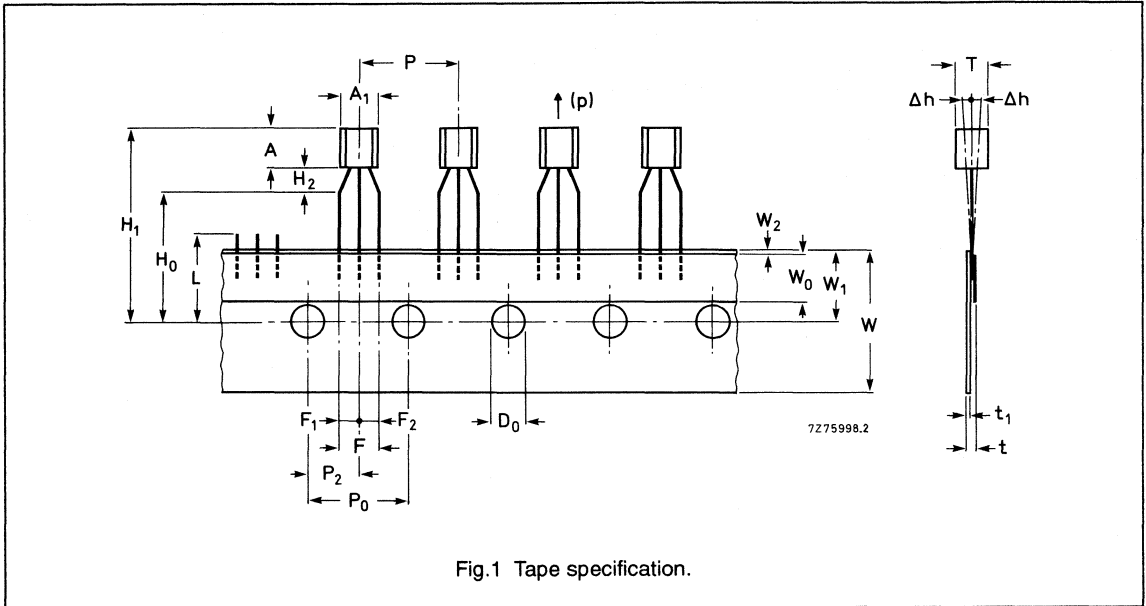

Fig.1 Tape specification.



## Small-signal Transistors

## Packing

## TAPE SPECIFICATION

SYMBOL	DIMENSION	SPECIFICATIONS					REMARKS
		MIN.	NOM.	MAX.	TOL.	UNIT	
A <sub>1</sub>	body width	4	–	4.8	–	mm	
A	body height	4.8	–	5.2	–	mm	
T	body thickness	3.5	–	3.9	–	mm	
P	pitch of component	–	12.7	–	±1	mm	
P <sub>0</sub>	feed hole pitch	–	12.7	–	±0.3	mm	
	cumulative pitch error	–	–	–	±0.1	mm	note 1
P <sub>2</sub>	feed hole centre to component centre	–	6.35	–	±0.4	mm	to be measured at bottom of clinch
F	distance between outer leads	–	5.08	–	+0.6/–0.2	mm	
Δh	component alignment	–	0	1	–	mm	at top of body
W	tape width	–	18	–	±0.5	mm	
W <sub>0</sub>	hold-down tape width	–	6	–	±0.2	mm	
W <sub>1</sub>	hole position	–	9	–	+0.7/–0.5	mm	
W <sub>2</sub>	hold-down tape position	–	0.5	–	±0.2	mm	
H <sub>0</sub>	lead wire clinch height	–	16.5	–	±0.5	mm	
H <sub>1</sub>	component height	–	–	23.25	–	mm	
L	length of snipped leads	–	–	11	–	mm	
D <sub>0</sub>	feed hole diameter	–	4	–	±0.2	mm	
t	total tape thickness	–	–	1.2	–	mm	t <sub>1</sub> 0.3 to 0.6
F <sub>1</sub> , F <sub>2</sub>	lead-to-lead distance	–	2.54	–	+0.4/–0.2	mm	
H <sub>2</sub>	clinch height	–	–	3	–	mm	
(p)	pull-out force	6	–	–	–	N	

## Note

1. Measured over 20 devices.

# Small-signal Transistors

# Packing

## PACKING

The transistors are supplied on tape in boxes (ammopack) or on reels. The number per reel and per ammopack is 2000. The ammopack has 80 layers of 25 transistors each. Each layer contains 25 transistors, plus one empty position in order to fold the layer correctly. The ammopack is accessible from both sides, enabling the user to choose between "normal" (see Fig.2) and "reverse" tape.

"Normal" is indicated by a plus sign (+) on the ammopack and "reverse" by a minus sign (-). In the European version, the leading pin is the emitter.

## DROPOUTS

A maximum of 0.5% of the specified number of transistors in each packing may be missing. Up to 3 consecutive components may be missing provided the gap is followed by 6 consecutive components.

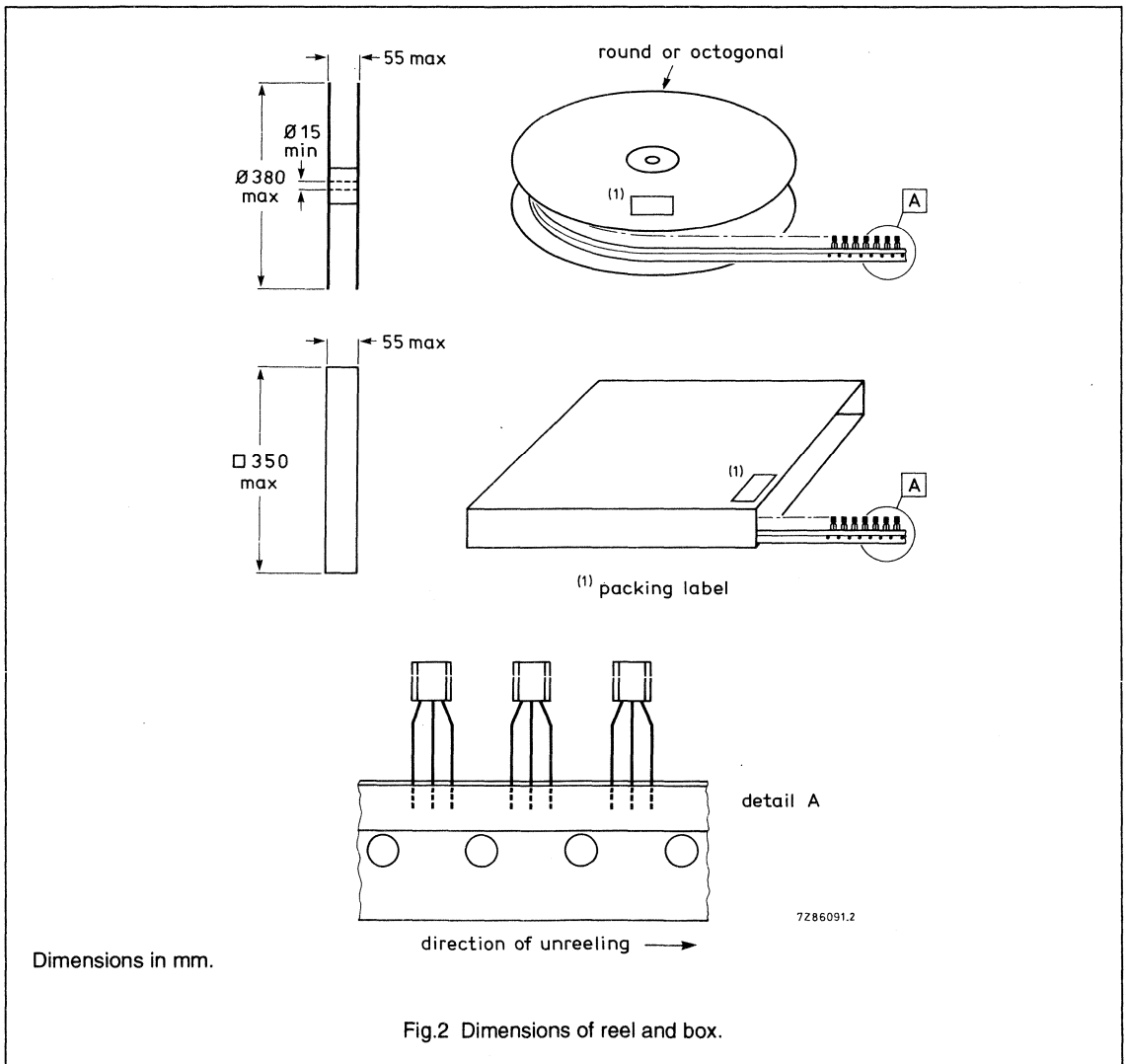

Fig.2 Dimensions of reel and box.

# Small-signal Transistors

# Packing

## TAPE SPLICING

Splice the carrier tape on the back and/or front so that the feed hole pitch ( $P_0$ ) is maintained (see Fig.3).

## BULK PACKING

In addition to TO-92 on tape, TO-92 can also be delivered in bulk. Products are packed in boxes in pink foil and plastic bags, 1000 pieces to a bag and 5 bags to

a box.

In addition to the standard TO-92 with straight leads, (see Fig.4) leads with delta pinning are available in bulk, on request (see Fig.5).

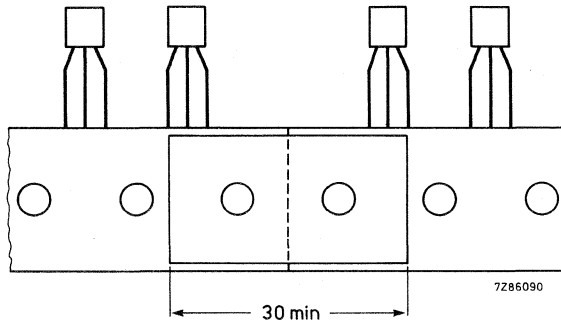

Fig.3 Jointing tape with splicing patch.

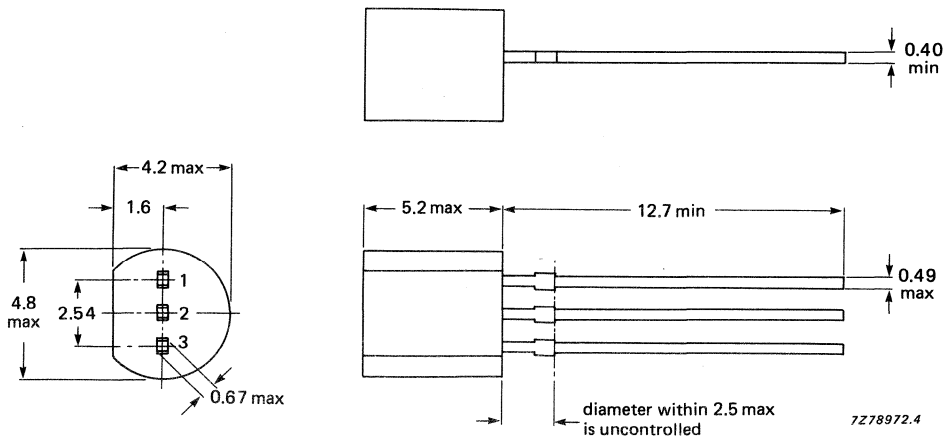

Fig.4 TO-92 with straight leads.

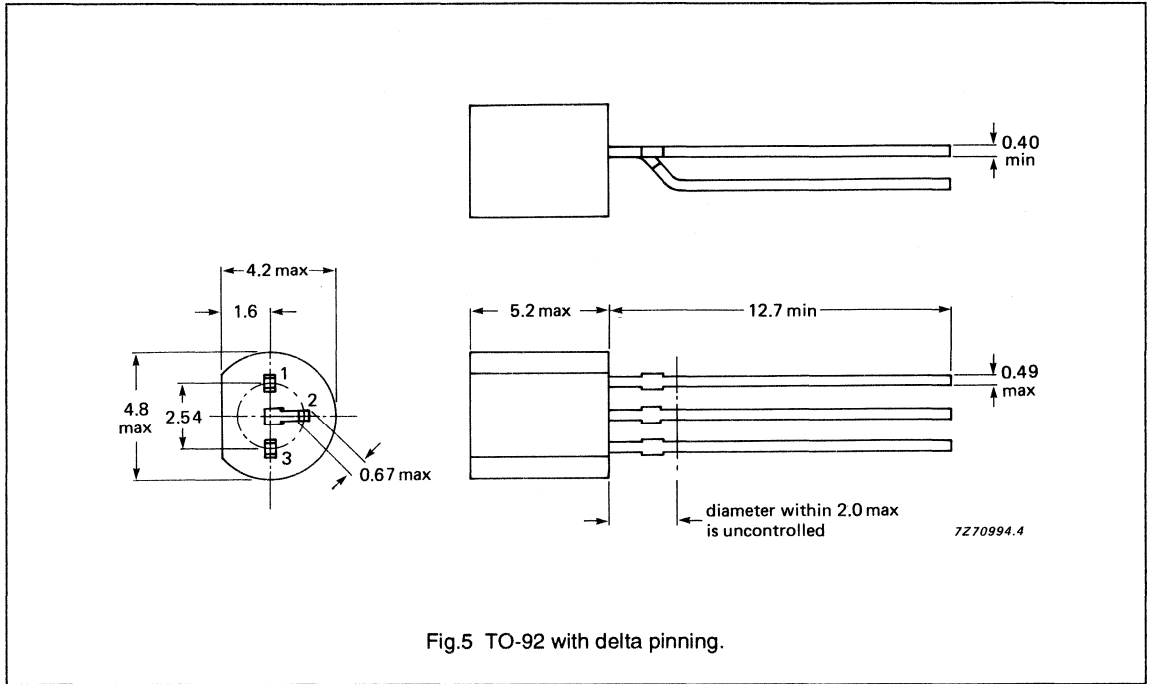

Fig.5 TO-92 with delta pinning.

**DEVICE DATA**

in alphanumerical sequence



## A.F. SILICON PLANAR EPITAXIAL TRANSISTORS



N-P-N transistors in TO-18 metal envelopes with the collector connected to the case.

The **BC107** is primarily intended for use in driver stages of audio amplifiers and in signal processing circuits of television receivers.

The **BC108** is suitable for multitude of low-voltage applications e.g. driver stages or audio preamplifiers and in signal processing circuits of television receivers.

The **BC109** is primarily intended for low-noise input stages in tape recorders, hi-fi amplifiers and other audio-frequency equipment.

## QUICK REFERENCE DATA

			BC107	BC108	BC109	
Collector-emitter voltage ( $V_{BE} = 0$ )	$V_{CES}$	max.	50	30	30	V
Collector-emitter voltage (open base)	$V_{CEO}$	max.	45	20	20	V
Collector current (peak value)	$I_{CM}$	max.	200	200	200	mA
Total power dissipation up to $T_{amb} = 25\text{ }^{\circ}\text{C}$	$P_{tot}$	max.	300	300	300	mW
Junction temperature	$T_j$	max.	175	175	175	$^{\circ}\text{C}$
Small-signal current gain at $T_j = 25\text{ }^{\circ}\text{C}$ $I_C = 2\text{ mA}$ ; $V_{CE} = 5\text{ V}$ ; $f = 1\text{ kHz}$	$h_{fe}$	>	125	125	240	
		<	500	900	900	
Transition frequency at $f = 35\text{ MHz}$ $I_C = 10\text{ mA}$ ; $V_{CE} = 5\text{ V}$	$f_T$	typ.	300	300	300	MHz
Noise figure at $R_S = 2\text{ k}\Omega$ $I_C = 200\text{ }\mu\text{A}$ ; $V_{CE} = 5\text{ V}$ $f = 30\text{ Hz to } 15\text{ kHz}$	F	typ.	—	—	1,4	dB
		<	—	—	4,0	dB
$f = 1\text{ kHz}$ ; $B = 200\text{ Hz}$	F	typ.	2	2	1,2	dB

## MECHANICAL DATA

Dimensions in mm

Fig. 1 TO-18.

Collector connected  
to case

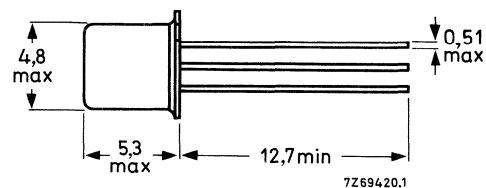
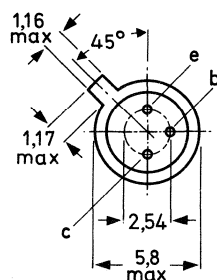

**RATINGS**

Limiting values in accordance with the Absolute Maximum System (IEC 134)

		BC107	BC108	BC109
Collector-base voltage (open emitter)	$V_{CBO}$	max. 50	30	30 V
Collector-emitter voltage ( $V_{BE} = 0$ )	$V_{CES}$	max. 50	30	30 V
Collector-emitter voltage (open base)	$V_{CEO}$	max. 45	20	20 V
Emitter-base voltage (open collector)	$V_{EBO}$	max. 6	5	5 V
Collector current (d.c.)	$I_C$	max.	100	mA
Collector current (peak value)	$I_{CM}$	max.	200	mA
Emitter current (peak value)	$-I_{EM}$	max.	200	mA
Base current (peak value)	$I_{BM}$	max.	200	mA
Total power dissipation up to $T_{amb} = 25\text{ }^\circ\text{C}$	$P_{tot}$	max.	300	mW
Storage temperature range	$T_{stg}$		-65 to +150	$^\circ\text{C}$
Junction temperature	$T_j$	max.	175	$^\circ\text{C}$

**THERMAL RESISTANCE**

From junction to ambient in free air	$R_{th\ j-a}$	=	0,5	K/mW
From junction to case	$R_{th\ j-c}$	=	0,2	K/mW

**CHARACTERISTICS**

$T_j = 25\text{ }^\circ\text{C}$  unless otherwise specified

Collector cut-off current

$I_E = 0; V_{CB} = 20\text{ V}; T_j = 150\text{ }^\circ\text{C}$

$I_{CBO}$	<	15	$\mu\text{A}$
-----------	---	----	---------------

Base-emitter voltage\*

$I_C = 2\text{ mA}; V_{CE} = 5\text{ V}$

$V_{BE}$	typ.	620	mV
		550 to 700	mV

$I_C = 10\text{ mA}; V_{CE} = 5\text{ V}$

$V_{BE}$	<	770	mV
----------	---	-----	----

Saturation voltages\*\*

$I_C = 10\text{ mA}; I_B = 0,5\text{ mA}$

$V_{CEsat}$	typ.	90	mV
	<	250	mV

$V_{BEsat}$	typ.	700	mV
-------------	------	-----	----

$I_C = 100\text{ mA}; I_B = 5\text{ mA}$

$V_{CEsat}$	typ.	200	mV
	<	600	mV

$V_{BEsat}$	typ.	900	mV
-------------	------	-----	----

\*  $V_{BE}$  decreases by about 2 mV/K with increasing temperature.

\*\*  $V_{BEsat}$  decreases by about 1,7 mV/K with increasing temperature.



Collector capacitance at  $f = 1$  MHz

$I_E = I_e = 0; V_{CB} = 10 \text{ V}$

$C_c$	typ.	2,5	pF
-------	------	-----	----

Emitter capacitance at  $f = 1$  MHz

$I_C = I_c = 0; V_{EB} = 0,5 \text{ V}$

$C_e$	typ.	9	pF
-------	------	---	----

Transition frequency at  $f = 35$  MHz

$I_C = 10 \text{ mA}; V_{CE} = 5 \text{ V}$

$f_T$	typ.	300	MHz
-------	------	-----	-----

Small signal current gain at  $f = 1$  kHz

$I_C = 2 \text{ mA}; V_{CE} = 5 \text{ V}$

		BC107	BC108	BC109
$h_{fe}$	>	125	125	240
	<	500	900	900

Noise figure at  $R_S = 2 \text{ k}\Omega$ 

$I_C = 200 \mu\text{A}; V_{CE} = 5 \text{ V}$

$f = 30 \text{ Hz to } 15 \text{ kHz}$

F	typ.			1,4 dB
	<			4 dB

$f = 1 \text{ kHz}; B = 200 \text{ Hz}$

F	typ.	2	2	1,2 dB
	<	10	10	4 dB

	BC107A	BC107B	BC108C
	BC108A	BC108B	BC109C
	BC109B		

D.C. current gain

$I_C = 10 \mu\text{A}; V_{CE} = 5 \text{ V}$

$h_{FE}$	>		40	100
	typ.	90	150	270

$I_C = 2 \text{ mA}; V_{CE} = 5 \text{ V}$

$h_{FE}$	>	110	200	420
	typ.	180	290	520
	<	220	450	800

h parameters at  $f = 1$  kHz (common emitter)

$I_C = 2 \text{ mA}; V_{CE} = 5 \text{ V}$

Input impedance

$h_{ie}$	>	1,6	3,2	6 k $\Omega$
	typ.	2,7	4,5	8,7 k $\Omega$
	<	4,5	8,5	15 k $\Omega$

Reverse voltage transfer ratio

$h_{re}$	typ.	1,5	2	3 $\cdot 10^{-4}$
----------	------	-----	---	-------------------

Small signal current gain

$h_{fe}$	>	125	240	450
	typ.	220	330	600
	<	260	500	900

Output admittance

$h_{oe}$	typ.	18	30	60 $\mu\Omega^{-1}$
	<	30	60	110 $\mu\Omega^{-1}$

Typical behaviour of collector current versus collector-emitter voltage

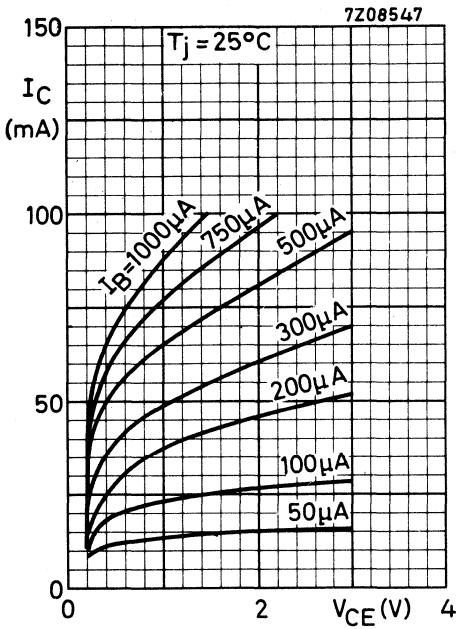

Fig. 2.

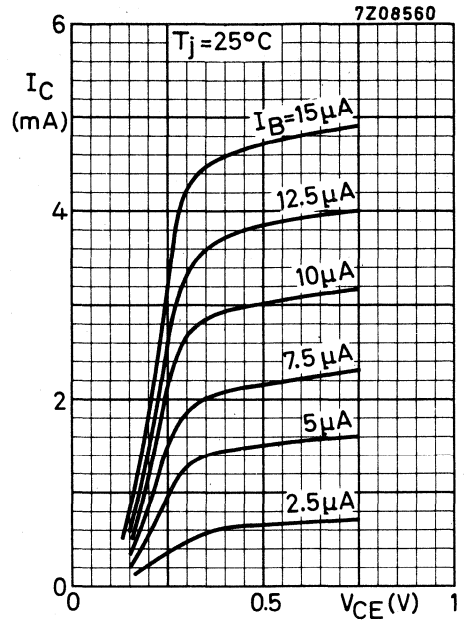

Fig. 3.

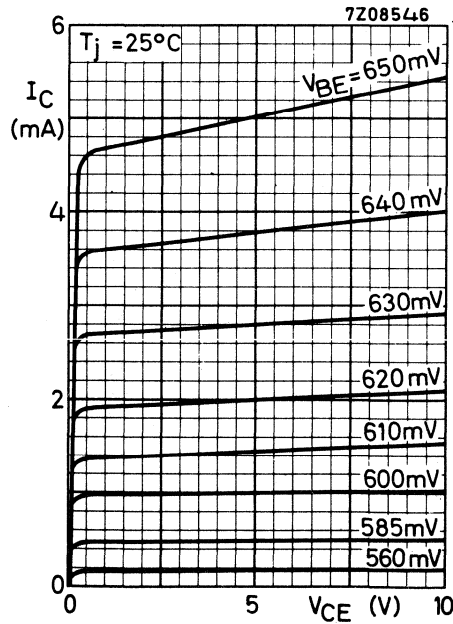

Fig. 4.

Typical behaviour of collector current versus collector-emitter voltage

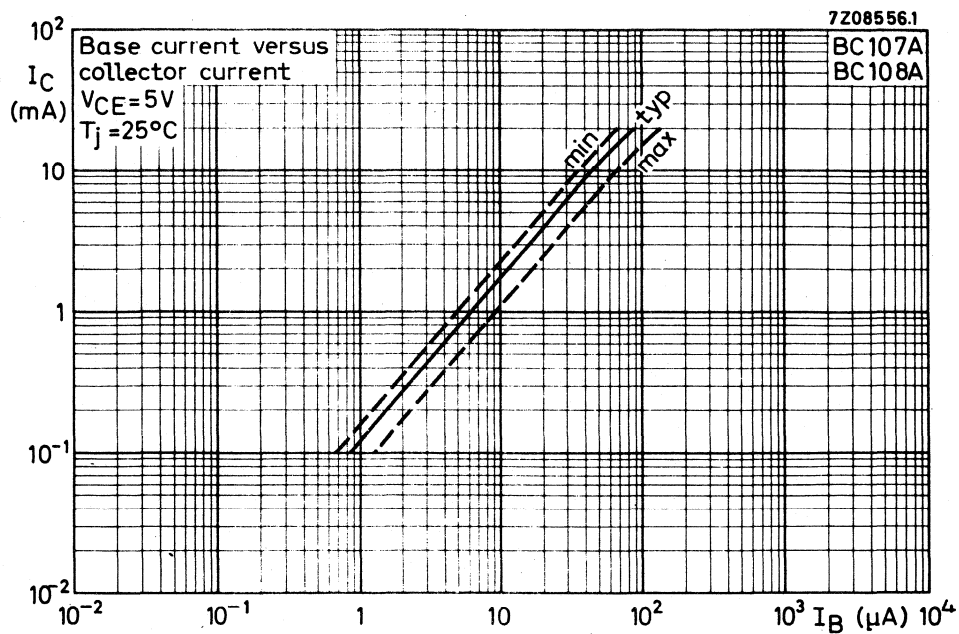

Fig. 5.

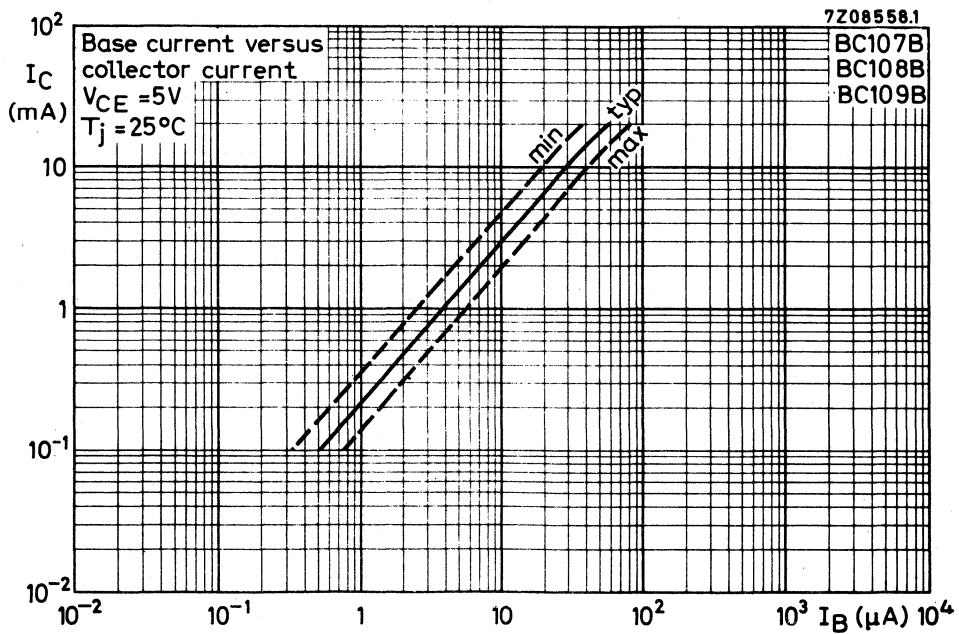

Fig. 6.

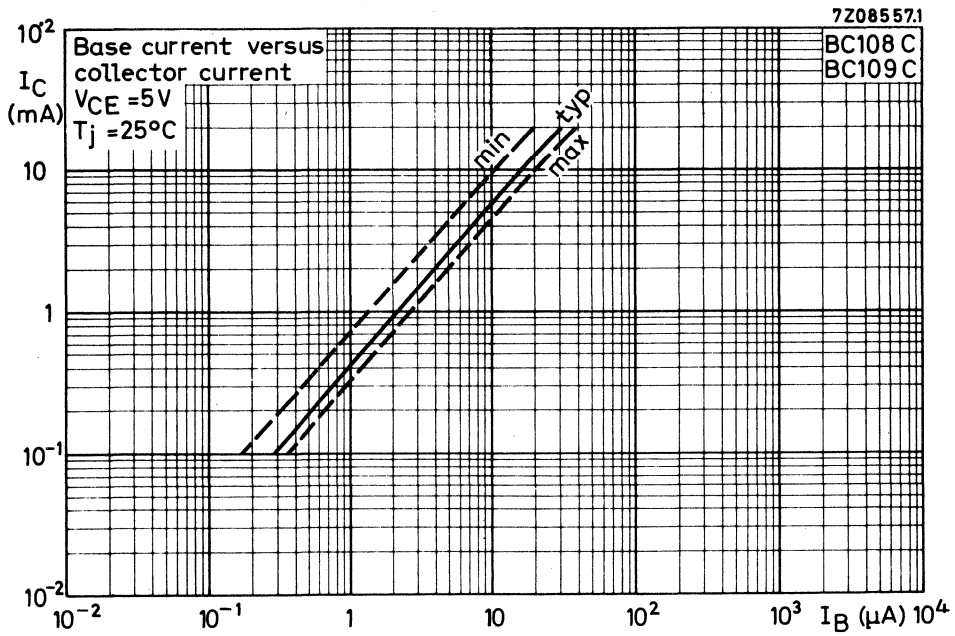

Fig. 7.

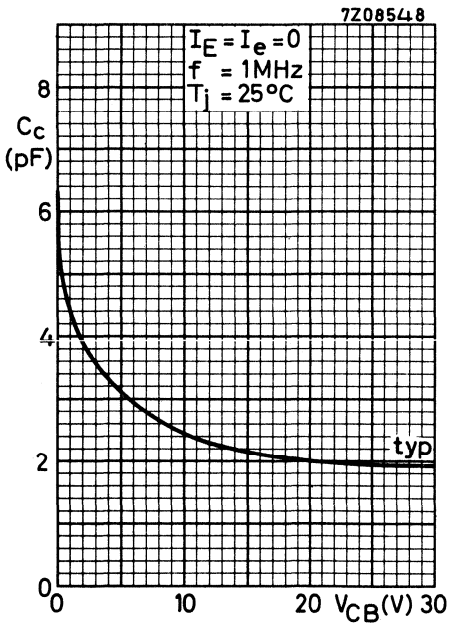

Fig. 8.

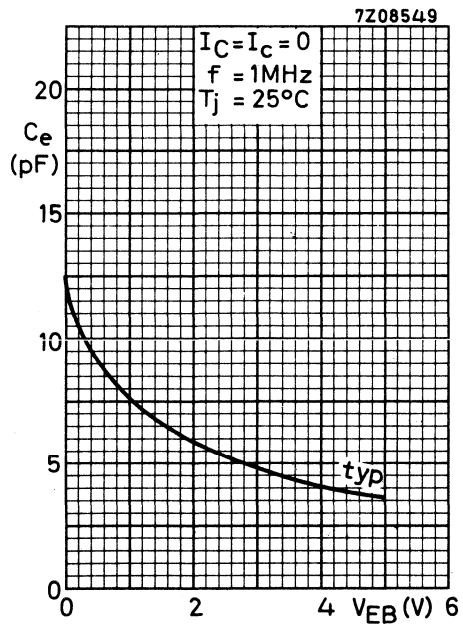

Fig. 9.

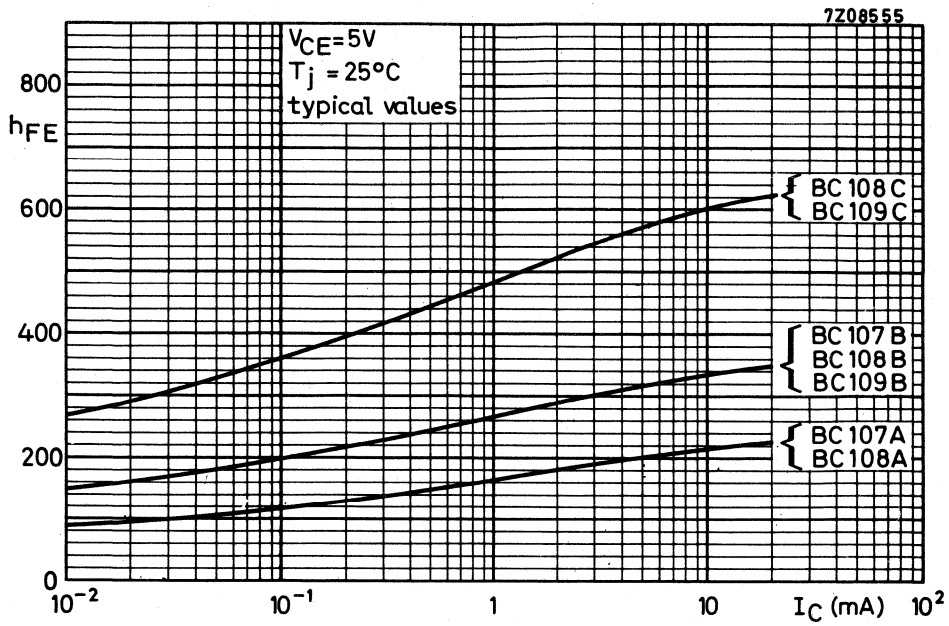

Fig. 10.

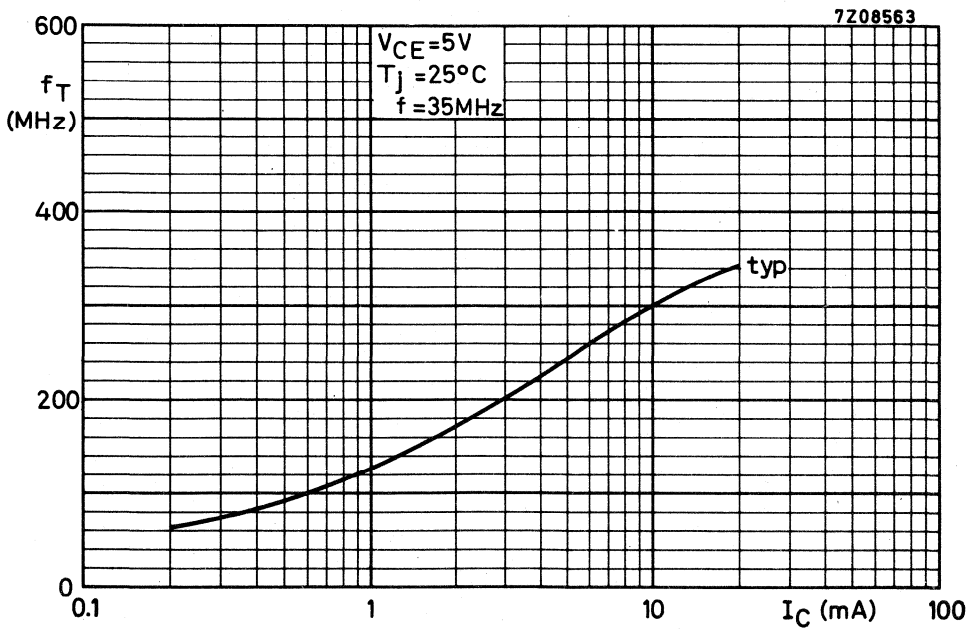

Fig. 11.

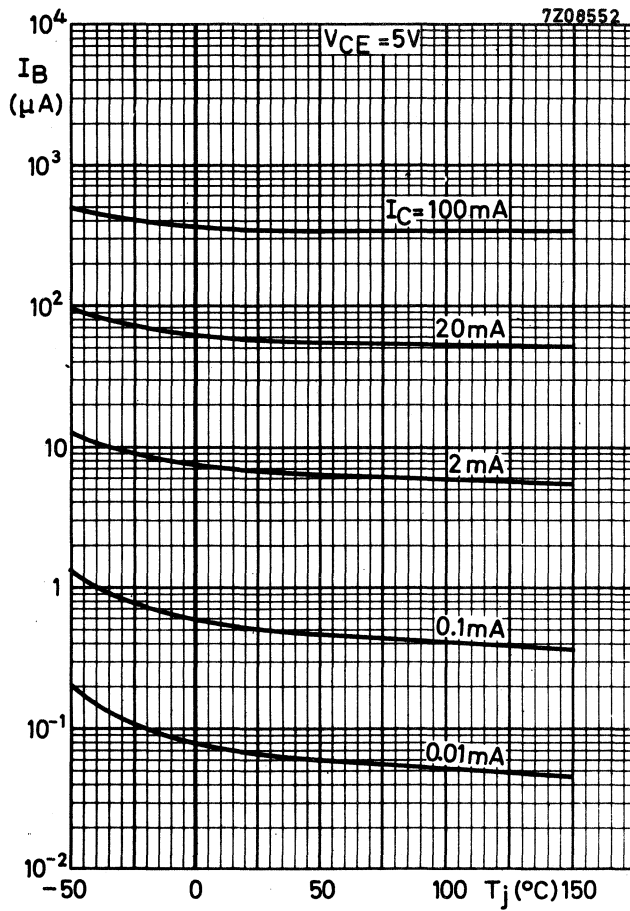

Fig. 12. Typical behaviour of base current versus junction temperature.

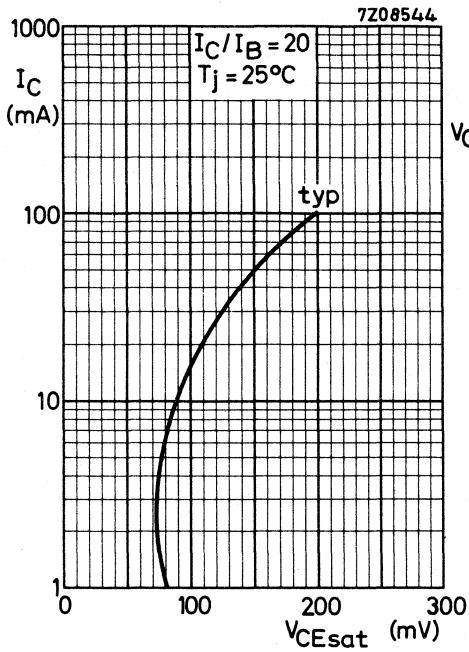

Fig. 13.

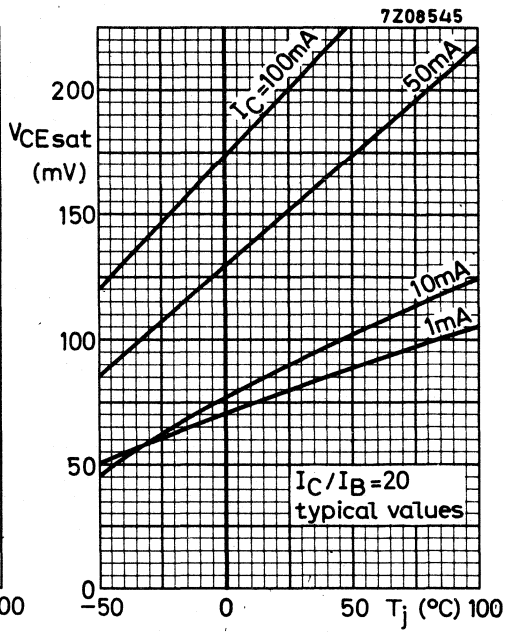

Fig. 14.

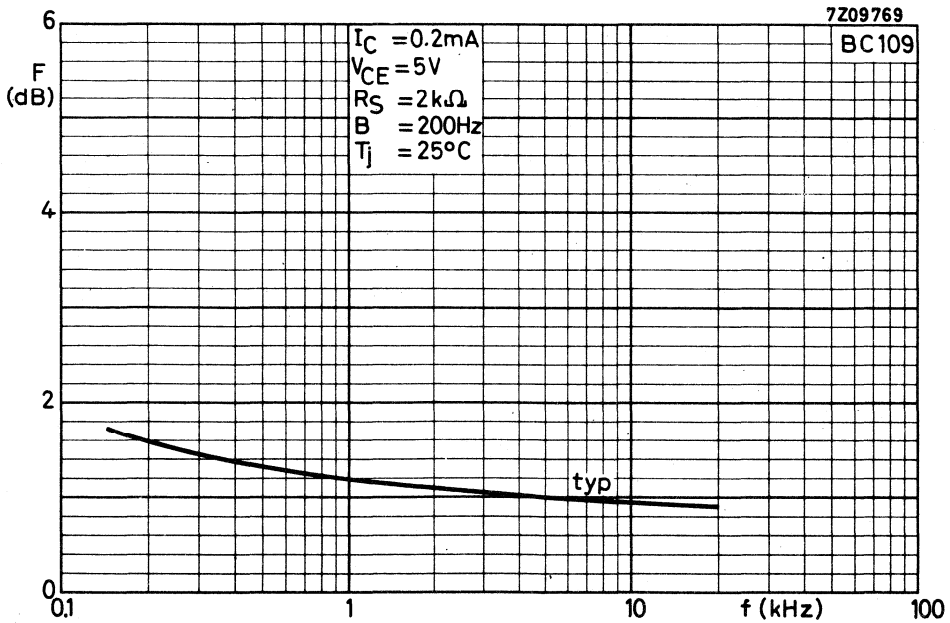

Fig. 15.

Curves of constant noise figure

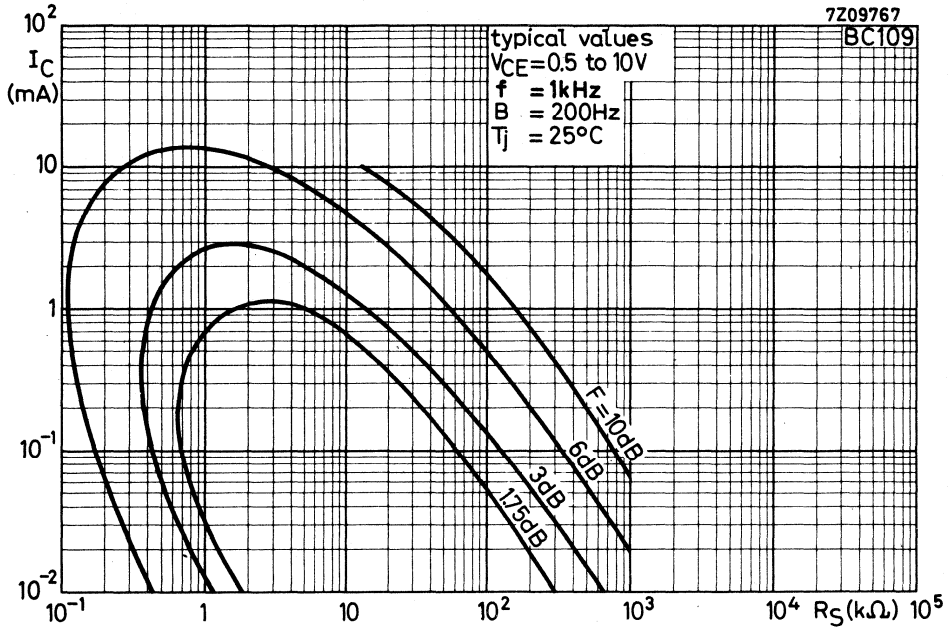

Fig. 16.

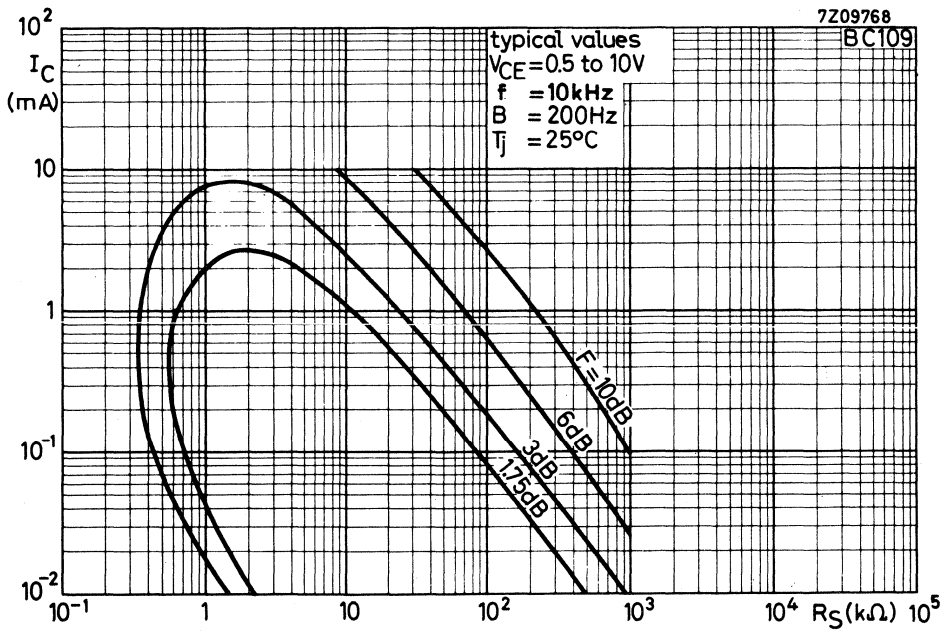

Fig. 17.



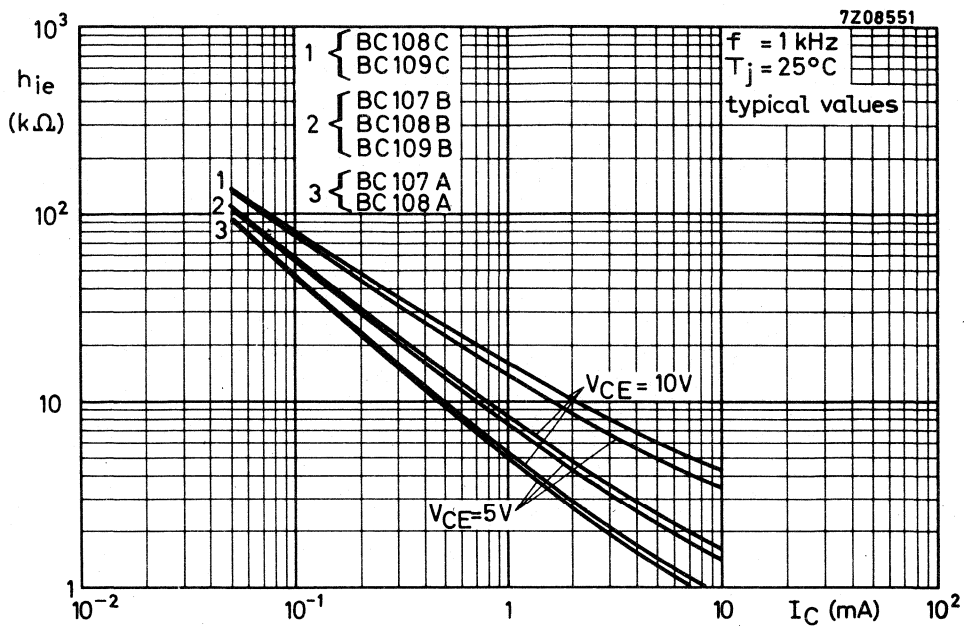

Fig. 18.

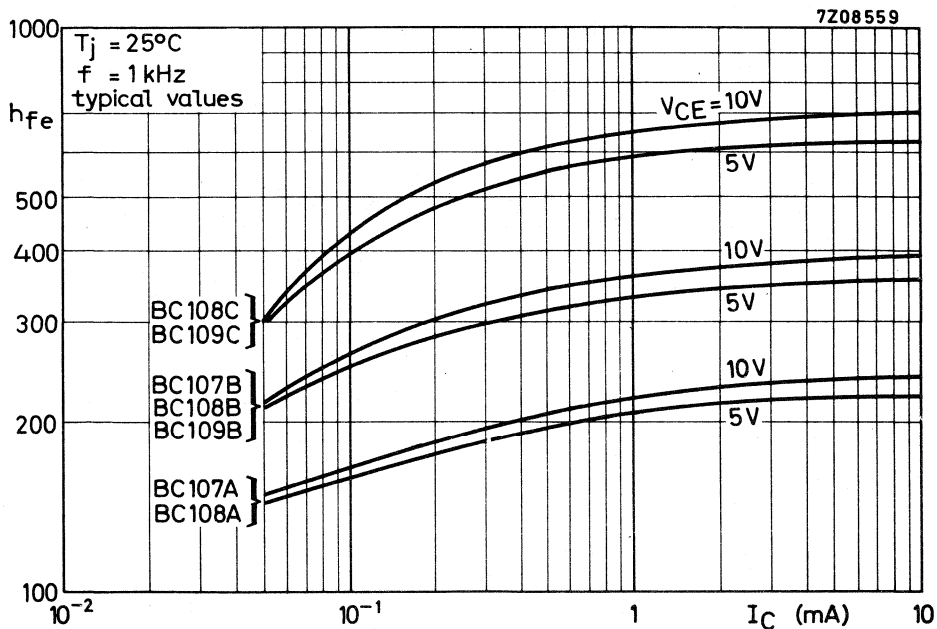

Fig. 19.

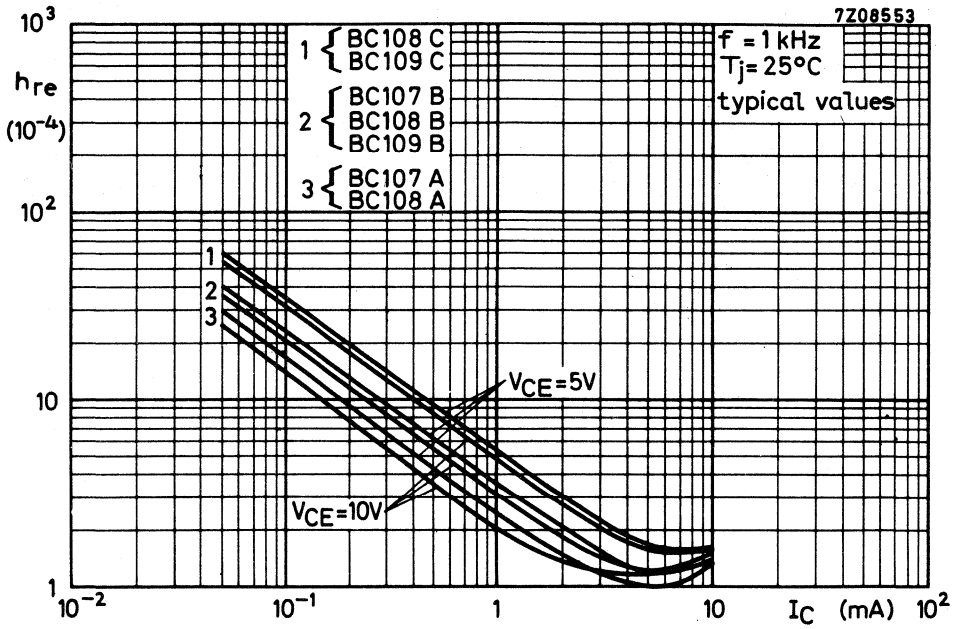

Fig. 20.

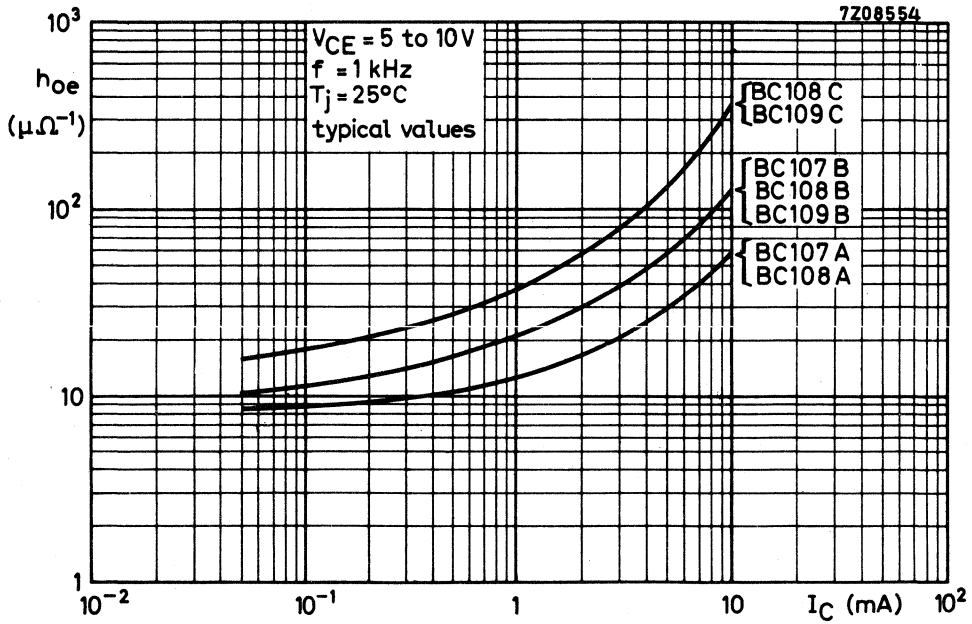

Fig. 21.

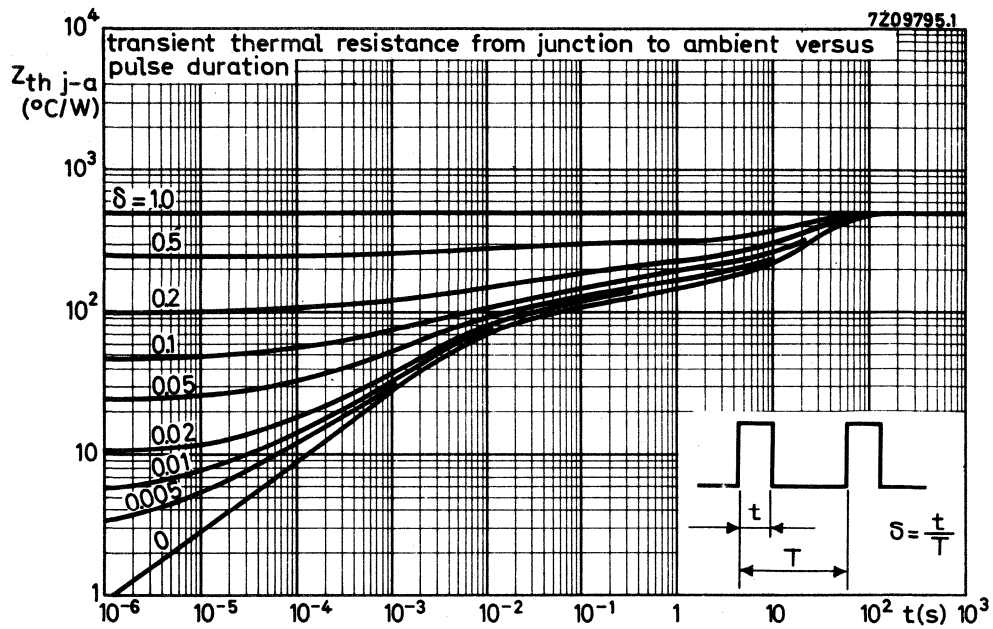

Fig. 22.





## SILICON PLANAR EPITAXIAL TRANSISTORS

N-P-N transistors in TO-39 metal envelopes for general purpose applications. P-N-P complements are BC160 and BC161.

### QUICK REFERENCE DATA

		BC140	BC141	
Collector-emitter voltage (open base)	$V_{CEO}$ max.	40	60	V
Collector current (d.c.)	$I_C$ max.	1		A
Total power dissipation up to $T_{case} = 45\text{ }^\circ\text{C}$	$P_{tot}$ max.	3,7		W
Junction temperature	$T_j$ max.	175		$^\circ\text{C}$
Transition frequency at $f = 20\text{ MHz}$ $I_C = 50\text{ mA}; V_{CE} = 10\text{ V}$	$f_T >$	50		MHz
		BC140-10 BC141-10	BC140-16 BC141-16	
D.C. current gain	$h_{FE} >$	63	100	
$I_C = 100\text{ mA}; V_{CE} = 1\text{ V}$	$h_{FE} <$	160	250	

### MECHANICAL DATA

Dimensions in mm

Fig. 1 TO-39.

Collector connected to case.

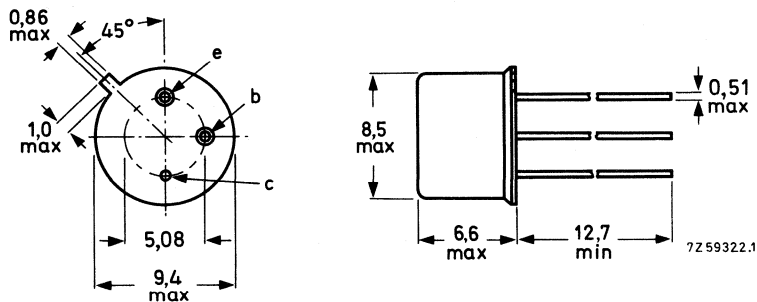

maximum lead diameter is guaranteed only for 12,7 mm.

**RATINGS**

Limiting values in accordance with the Absolute Maximum System (IEC 134)

		BC140	BC141	
Collector-base voltage (open emitter)	$V_{CBO}$	max. 80	100	V
Collector-emitter voltage (open base)	$V_{CEO}$	max. 40	60	V
Emitter-base voltage (open collector)	$V_{EBO}$	max. 7	7	V
Collector current (d.c.)	$I_C$	max. 1		A
Base current (d.c.)	$I_B$	max. 100		mA
Total power dissipation up to $T_{case} = 45\text{ }^\circ\text{C}$	$P_{tot}$	max. 3,7		W
Storage temperature range	$T_{stg}$	-65 to + 150		$^\circ\text{C}$
Junction temperature	$T_j$	max. 175		$^\circ\text{C}$

**THERMAL RESISTANCE**

From junction to ambient in free air	$R_{th\ j-a}$	=	200	K/W
From junction to case	$R_{th\ j-c}$	=	35	K/W

**CHARACTERISTICS**

$T_{amb} = 25\text{ }^\circ\text{C}$  unless otherwise specified

Collector cut-off current $V_{BE} = 0; V_{CE} = 60\text{ V}$	$I_{CES}$	typ. <	10 100	nA nA
$V_{BE} = 0; V_{CE} = 60\text{ V}; T_{amb} = 150\text{ }^\circ\text{C}$	$I_{CES}$	typ. <	10 100	$\mu\text{A}$ $\mu\text{A}$
Base-emitter voltage $I_C = 1\text{ A}; V_{CE} = 1\text{ V}$	$V_{BE}$	typ. <	1,2 1,8	V V
Saturation voltage $I_C = 1\text{ A}; I_B = 100\text{ mA}$	$V_{CEsat}$	typ. <	0,6 1,0	V V
Transition frequency at $f = 20\text{ MHz}$ $I_C = 50\text{ mA}; V_{CE} = 10\text{ V}$	$f_T$	>	50	MHz
Collector capacitance at $f = 1\text{ MHz}$ $I_E = I_e = 0; V_{CB} = 10\text{ V}$	$C_C$	<	25	pF
Emitter capacitance at $f = 1\text{ MHz}$ $I_C = I_c = 0; V_{EB} = 0,5\text{ V}$	$C_E$	<	80	pF

			BC140-10 BC141-10	BC140-16 BC141-16
D.C. current gain $I_C = 100\text{ }\mu\text{A}; V_{CE} = 1\text{ V}$	$h_{FE}$	typ. >	40 60	90 100
$I_C = 100\text{ mA}; V_{CE} = 1\text{ V}$	$h_{FE}$	typ. <	100 160	160 250
$I_C = 1\text{ A}; V_{CE} = 1\text{ V}$	$h_{FE}$	typ.	20	30

## CHARACTERISTICS (continued)

 $T_{amb} = 25\text{ }^{\circ}\text{C}$ 

Switching times

 $I_{Con} = 100\text{ mA}; I_{Bon} = -I_{Boff} = 5\text{ mA}$ 

Turn-on time

 $t_{on} < 250\text{ ns}$ 

Turn-off time

 $t_{off} < 850\text{ ns}$ 

Fig. 2 Test circuit.

Pulse generator:

Pulse duration  $t_p = 10\text{ }\mu\text{s}$ Rise time  $t_r \leq 15\text{ ns}$ Fall time  $t_f \leq 15\text{ ns}$ Source impedance  $Z_s = 50\text{ }\Omega$ 

Oscilloscope:

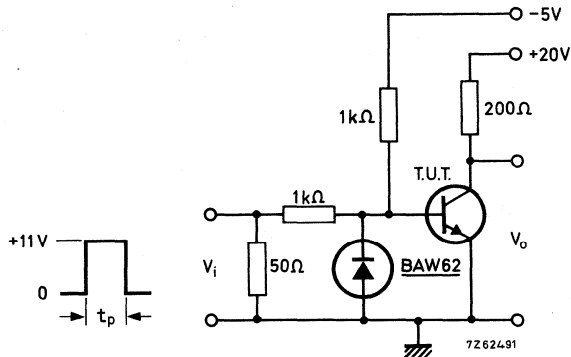
Rise time  $t_r \leq 15\text{ ns}$ Input impedance  $Z_i \geq 100\text{ k}\Omega$







## SILICON PLANAR EPITAXIAL TRANSISTORS

P-N-P transistors in TO-39 metal envelopes for general purpose applications. N-P-N complements are BC140 and BC141.

### QUICK REFERENCE DATA

		BC160	BC161	
Collector-emitter voltage (open base)	$-V_{CE0}$ max.	40	60	V
Collector current (d.c.)	$-I_C$ max.	1		A
Total power dissipation up to $T_{case} = 45^\circ\text{C}$	$P_{tot}$ max.	3,7		W
Junction temperature	$T_j$ max.	175		$^\circ\text{C}$
Transition frequency at $f = 20\text{ MHz}$ $-I_C = 50\text{ mA}; -V_{CE} = 10\text{ V}$	$f_T >$	50		MHz
		BC160-10 BC161-10	BC160-16 BC161-16	
D.C. current gain $-I_C = 100\text{ mA}; -V_{CE} = 1\text{ V}$	$h_{FE} >$ $<$	63 160	100 250	

### MECHANICAL DATA

Dimensions in mm

Fig. 1 TO-39.

Collector connected to case.

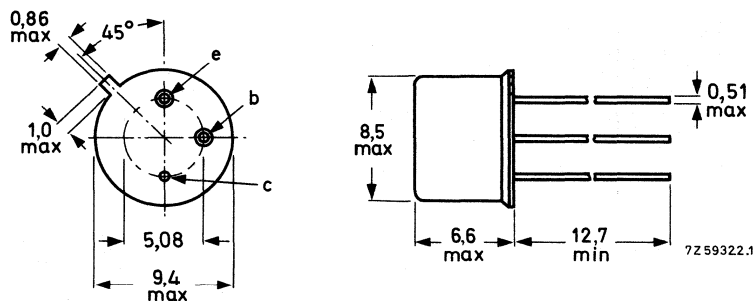

maximum lead diameter is guaranteed only for 12,7 mm.

**RATINGS**

Limiting values in accordance with the Absolute Maximum System (IEC 134)

		BC160	BC161	
Collector-base voltage (open emitter)	$-V_{CBO}$	max. 40	60	V
Collector-emitter voltage (open base)	$-V_{CEO}$	max. 40	60	V
Emitter-base voltage (open collector)	$-V_{EBO}$	max. 5	5	V
Collector current (d.c.)	$-I_C$	max. 1		A
Base current (d.c.)	$-I_B$	max. 100		mA
Total power dissipation up to $T_{case} = 45\text{ }^{\circ}\text{C}$	$P_{tot}$	max. 3,7		W
Storage temperature range	$T_{stg}$	-65 to + 150		$^{\circ}\text{C}$
Junction temperature	$T_j$	max. 175		$^{\circ}\text{C}$

**THERMAL RESISTANCE**

From junction to ambient in free air	$R_{thj-a}$	=	200	K/W
From junction to case	$R_{thj-c}$	=	35	K/W

**CHARACTERISTICS**

$T_{amb} = 25\text{ }^{\circ}\text{C}$  unless otherwise specified

Collector cut-off current $V_{BE} = 0; -V_{CE} = -V_{CEOmax}$	$-I_{CES}$	typ. <	10 100	nA nA
$V_{BE} = 0; -V_{CE} = -V_{CEOmax};$ $T_{amb} = 150\text{ }^{\circ}\text{C}$	$-I_{CES}$	typ. <	10 100	$\mu\text{A}$ $\mu\text{A}$
Base-emitter voltage $-I_C = 1\text{ A}; -V_{CE} = 1\text{ V}$	$-V_{BE}$	typ. <	1,0 1,7	V V
Saturation voltage $-I_C = 1\text{ A}; -I_B = 100\text{ mA}$	$-V_{CEsat}$	typ. <	0,6 1,0	V V
Transition frequency at $f = 20\text{ MHz}$ $-I_C = 50\text{ mA}; -V_{CE} = 10\text{ V}$	$f_T$	>	50	MHz
Collector capacitance at $f = 1\text{ MHz}$ $I_E = I_e = 0; -V_{CB} = 10\text{ V}$	$C_c$	<	30	pF
Emitter capacitance at $f = 1\text{ MHz}$ $I_C = I_c = 0; -V_{EB} = 0,5\text{ V}$	$C_e$	<	180	pF
<b>BC160-10   BC160-16</b>				
<b>BC161-10   BC161-16</b>				
D.C. current gain $-I_C = 100\text{ }\mu\text{A}; -V_{CE} = 1\text{ V}$	$h_{FE}$	typ. >	80 63	120 100
$-I_C = 100\text{ mA}; -V_{CE} = 1\text{ V}$	$h_{FE}$	typ. <	100 160	160 250
$-I_C = 1\text{ A}; -V_{CE} = 1\text{ V}$	$h_{FE}$	typ.	20	30

**CHARACTERISTICS (continued)**

$T_{amb} = 25\text{ }^{\circ}\text{C}$

Switching times

$-I_{Con} = 100\text{ mA}; -I_{Bon} = I_{Boff} = 5\text{ mA}$

Turn-on time

$t_{on} < 500\text{ ns}$

Turn-off time

$t_{off} < 650\text{ ns}$

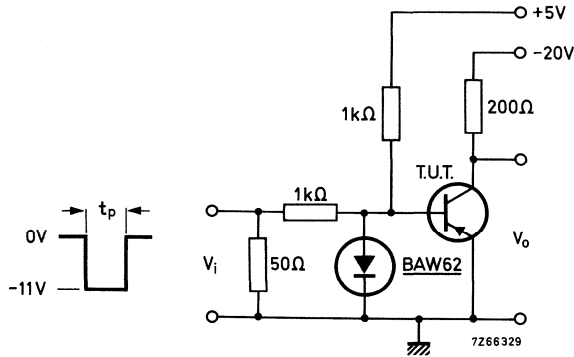

Fig. 2 Test circuit.

Pulse generator:

Pulse duration  $t_p = 10\text{ }\mu\text{s}$

Rise time  $t_r \leq 15\text{ ns}$

Fall time  $t_f \leq 15\text{ ns}$

Source impedance  $Z_s = 50\text{ }\Omega$

Oscilloscope:

Rise time  $t_r \leq 15\text{ ns}$

Input impedance  $Z_i \geq 100\text{ k}\Omega$



## A.F. SILICON PLANAR EPITAXIAL TRANSISTORS



P-N-P transistors in TO-18 metal envelopes with the collector connected to the case.

The **BC177** is a high-voltage type and primarily intended for use in driver stages of audio amplifiers and in signal processing circuits of television receivers.

The **BC178** is suitable for a multitude of low-voltage applications e.g. driver stages or audio preamplifiers and in signal processing circuits of television receivers.

The **BC179** is primarily intended for low-noise input stages in tape recorders, hi-fi amplifiers and other audio-frequency equipment.

Moreover, they are intended as complementary types for the BC107, BC108 and BC109.

## QUICK REFERENCE DATA

			BC177	BC178	BC179	
Collector-emitter voltage (+ $V_{BE} = 1\text{ V}$ )	$-V_{CEX}$	max.	50	30	25	V
Collector-emitter voltage (open base)	$-V_{CEO}$	max.	45	25	20	V
Collector current (peak value)	$-I_{CM}$	max.	200	200	200	mA
Total power dissipation up to $T_{amb} = 25\text{ }^{\circ}\text{C}$	$P_{tot}$	max.	300	300	300	mW
Junction temperature	$T_j$	max.	175	175	175	$^{\circ}\text{C}$
Small-signal current gain at $T_j = 25\text{ }^{\circ}\text{C}$ $-I_C = 2\text{ mA}$ ; $-V_{CE} = 5\text{ V}$ ; $f = 1\text{ kHz}$	$h_{fe}$	> <	125 500	125 500	125 500	
Transition frequency at $f = 35\text{ MHz}$ $-I_C = 10\text{ mA}$ ; $-V_{CE} = 5\text{ V}$	$f_T$	typ.	150	150	150	MHz
Noise figure at $R_S = 2\text{ k}\Omega$ $-I_C = 200\text{ }\mu\text{A}$ ; $-V_{CE} = 5\text{ V}$ $f = 30\text{ Hz}$ to $15\text{ kHz}$	F	typ. <	— —	— —	1,2 4,0	dB
$f = 1\text{ kHz}$ ; B = 200 Hz	F	<	10	10	4,0	dB

## MECHANICAL DATA

Dimensions in mm

Fig. 1 TO-18.

Collector  
connected  
to case

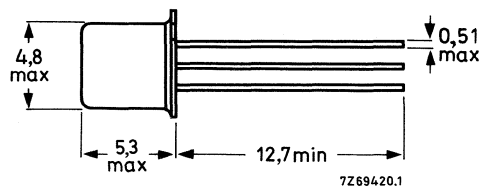
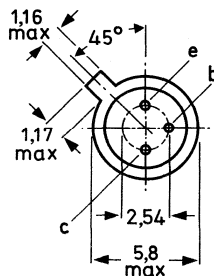

Accessories: 56246 (distance disc).

Qualification approved to CECC 50 002-012/013/014

**RATINGS**

Limiting values in accordance with the Absolute Maximum System (IEC 134)

		BC177	BC178	BC179
Collector-base voltage (open emitter)	$-V_{CBO}$	max. 50	30	25 V
Collector-emitter voltage (+ $V_{BE} = 1$ V)	$-V_{CEX}$	max. 50	30	25 V
Collector-emitter voltage (open base)	$-V_{CEO}$	max. 45	25	20 V
Emitter-base voltage (open collector)	$-V_{EBO}$	max. 5	5	5 V
Collector current (d.c.)	$-I_C$	max.	100	mA
Collector current (peak value)	$-I_{CM}$	max.	200	mA
Emitter current (peak value)	$I_{EM}$	max.	200	mA
Total power dissipation up to $T_{amb} = 25$ °C	$P_{tot}$	max.	300	mW
Storage temperature range	$T_{stg}$		-65 to + 150	°C
Junction temperature	$T_j$	max.	175	°C

**THERMAL RESISTANCE**

From junction to ambient in free air	$R_{thj-a}$	=	0,5	K/mW
From junction to case	$R_{thj-c}$	=	0,2	K/mW

**CHARACTERISTICS**

$T_j = 25$  °C unless otherwise specified

Collector cut-off current				
$I_E = 0; -V_{CB} = 20$ V	$-I_{CBO}$	typ. <	1 100	nA nA
$T_j = 150$ °C	$-I_{CBO}$	<	10	$\mu$ A
Base-emitter voltage*				
$-I_C = 2$ mA; $-V_{CE} = 5$ V	$-V_{BE}$	typ.	650 600 to 750	mV mV
Saturation voltages				
$-I_C = 10$ mA; $-I_B = 0,5$ mA	$-V_{CEsat}$	typ. <	75 300	mV mV
	$-V_{BEsat}$	typ.	700	mV
$-I_C = 100$ mA; $-I_B = 5$ mA	$-V_{CEsat}$	typ.	250	mV
	$-V_{BEsat}$	typ.	850	mV
Collector capacitance at $f = 1$ MHz				
$I_E = I_e = 0; -V_{CB} = 10$ V	$C_C$	typ.	4,0	pF
Transition frequency at $f = 35$ MHz				
$-I_C = 10$ mA; $-V_{CE} = 5$ V	$f_T$	typ.	150	MHz

\*  $-V_{BE}$  decreases by about 2 mV/K with increasing temperature.

		BC177	BC178	BC179
Noise figure at $R_S = 2 \text{ k}\Omega$				
$-I_C = 200 \mu\text{A}; -V_{CE} = 5 \text{ V}$				
$f = 30 \text{ Hz to } 15 \text{ kHz}$				
F	typ.			1,2 dB
	<			4 dB
$f = 1 \text{ kHz}; B = 200 \text{ Hz}$				
F	typ.	2	2	1 dB
	<	10	10	4 dB
		BC177	BC177A	BC177B
		BC178	BC178A	BC178B
			BC179A	BC179B
D.C. current gain				
$-I_C = 2 \text{ mA}; -V_{CE} = 5 \text{ V}$				
$h_{FE}$	typ.	140	180	290
Small signal current gain at $f = 1 \text{ kHz}$				
$-I_C = 2 \text{ mA}; -V_{CE} = 5 \text{ V}$				
$h_{fe}$	>	125	125	125
	<	500	500	500

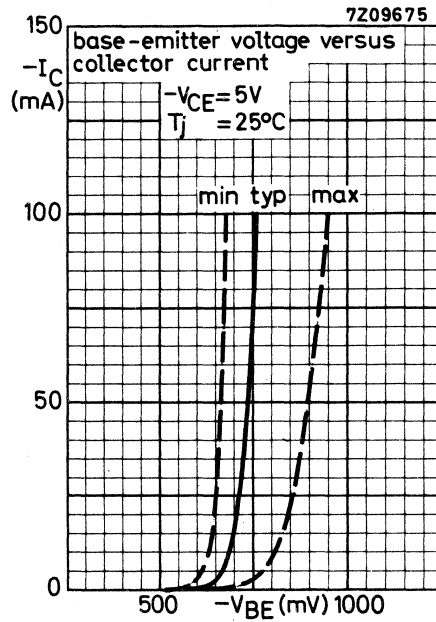

Fig. 2.

Typical behaviour of collector current versus collector-emitter voltage

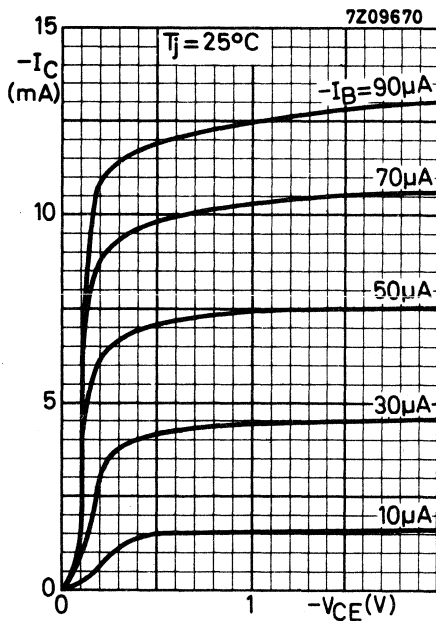

Fig. 3.

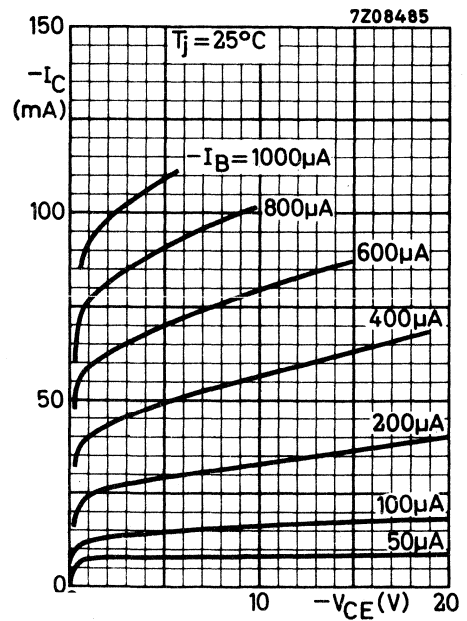

Fig. 4.



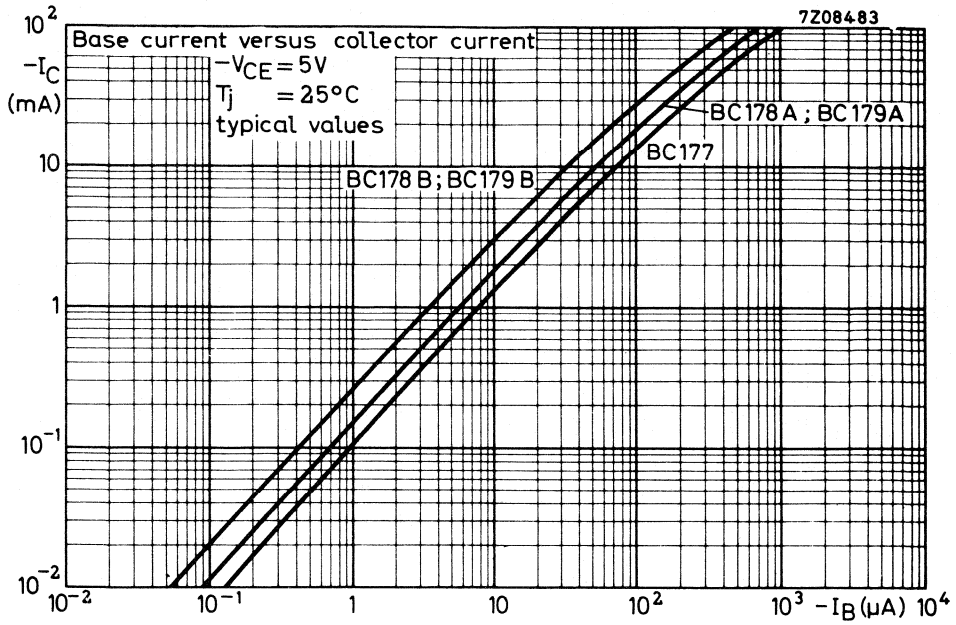

Fig. 5.

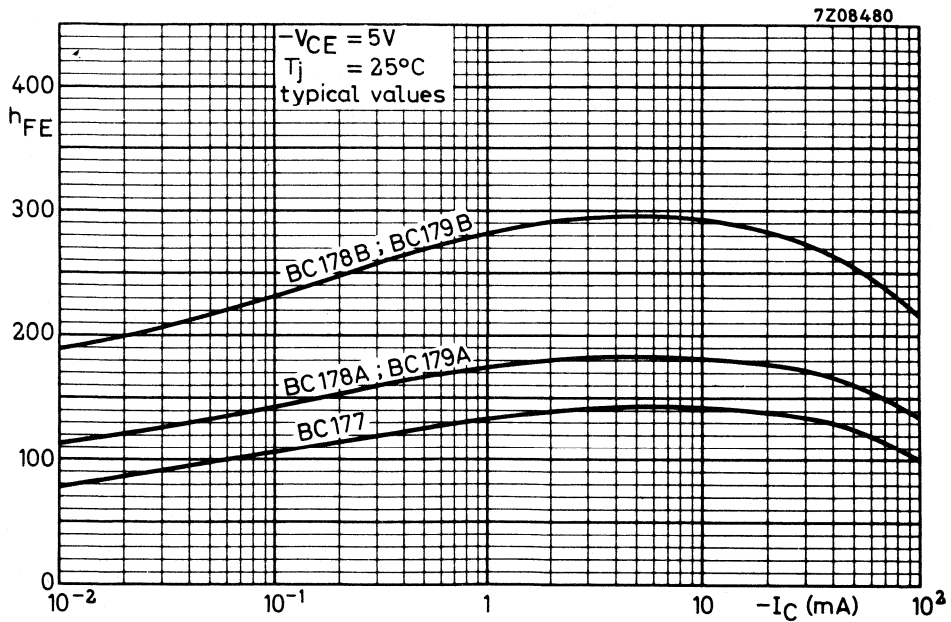

Fig. 6.

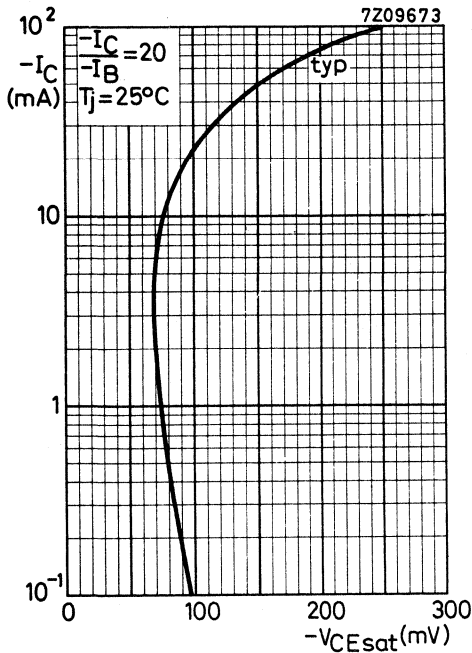

Fig. 7.

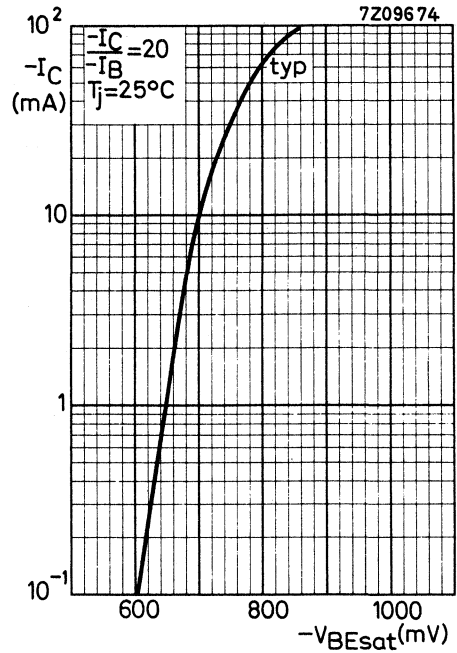

Fig. 8.

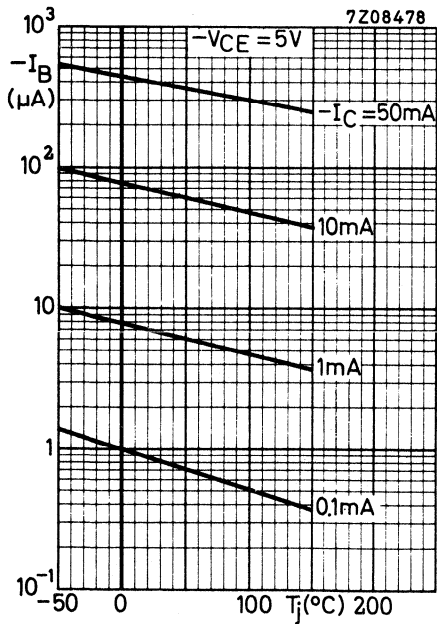

Fig. 9.

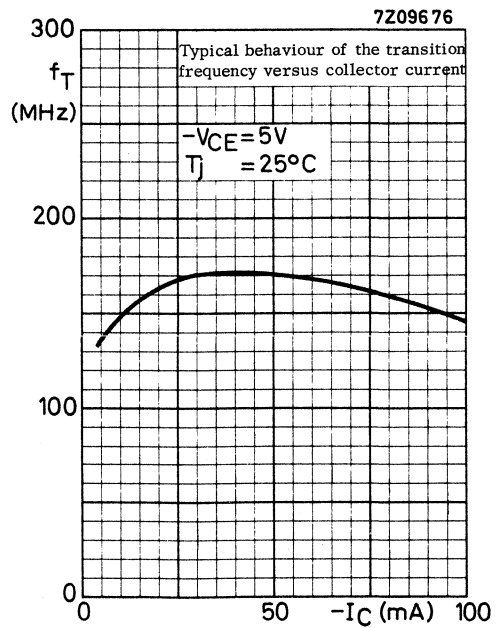

Fig. 10.

Typical behaviour of base current versus junction temperature.

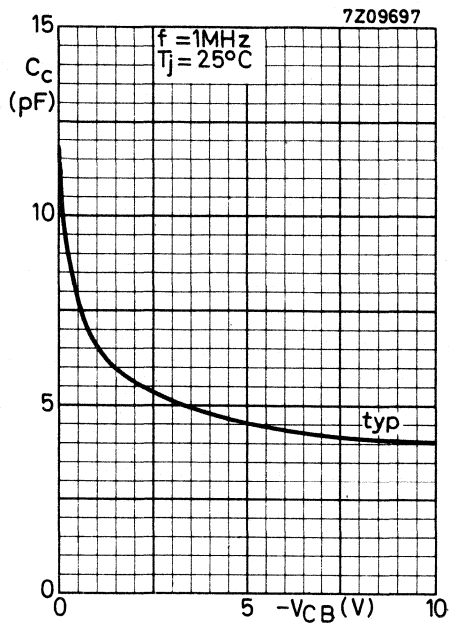

Fig. 11.

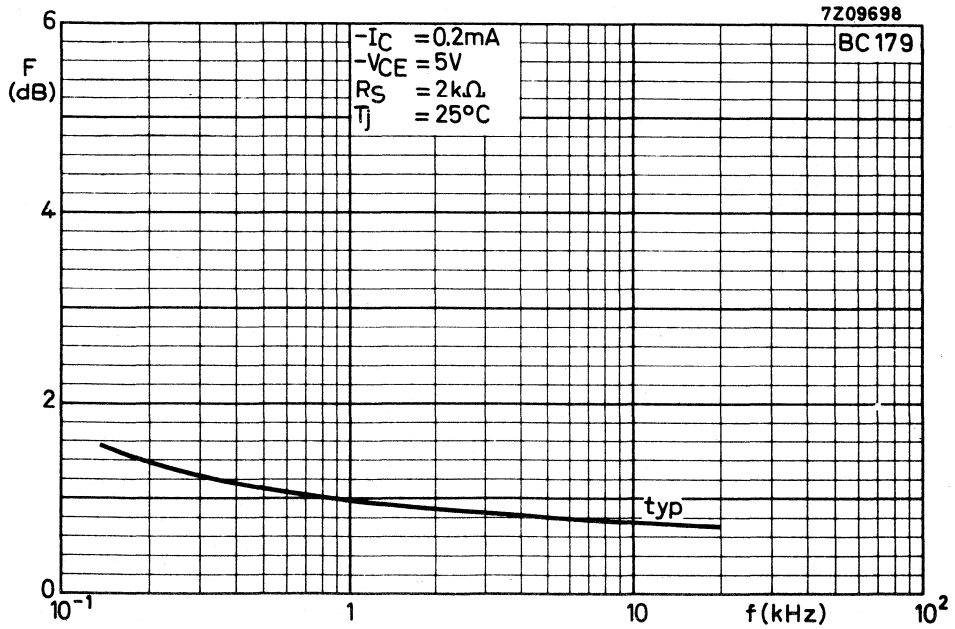

Fig. 12.

Curves of constant noise figure

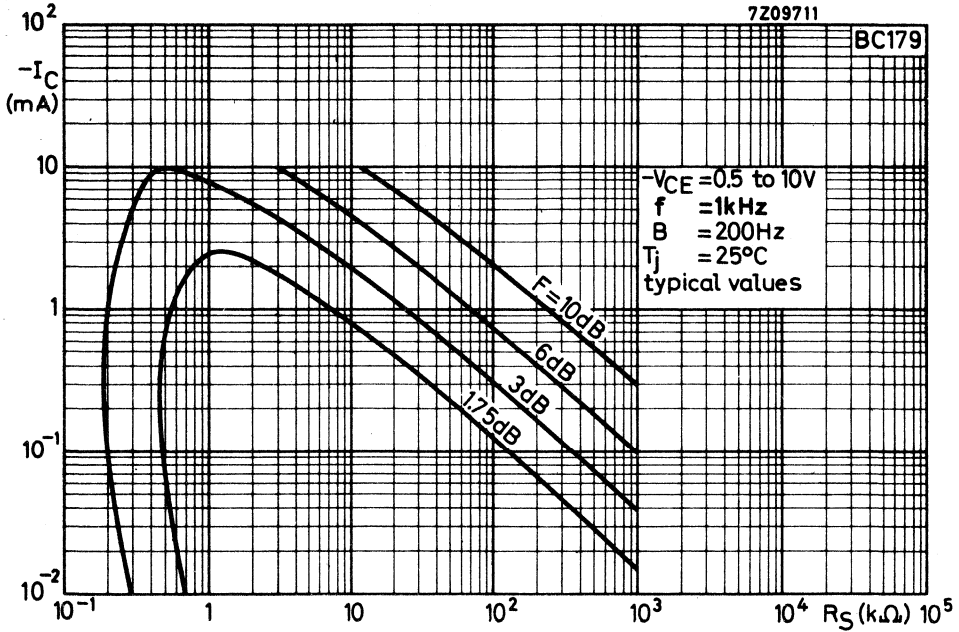

Fig. 13.

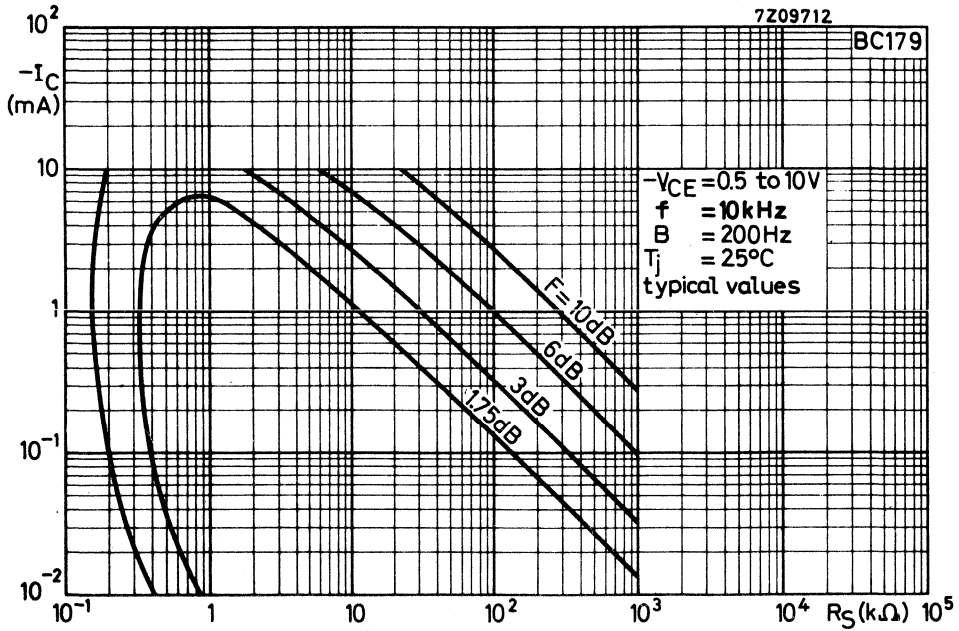

Fig. 14.

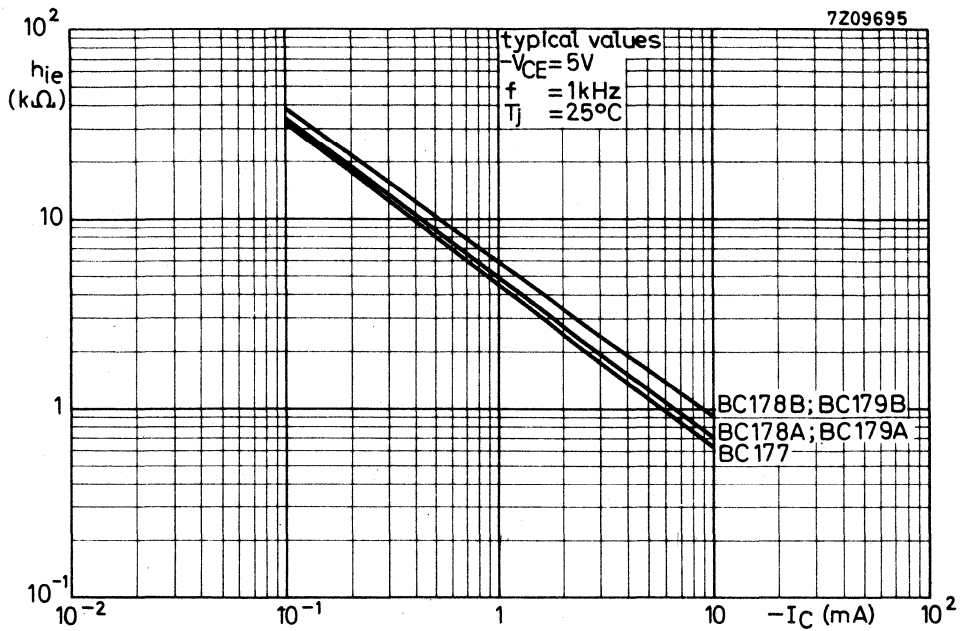

Fig. 15.

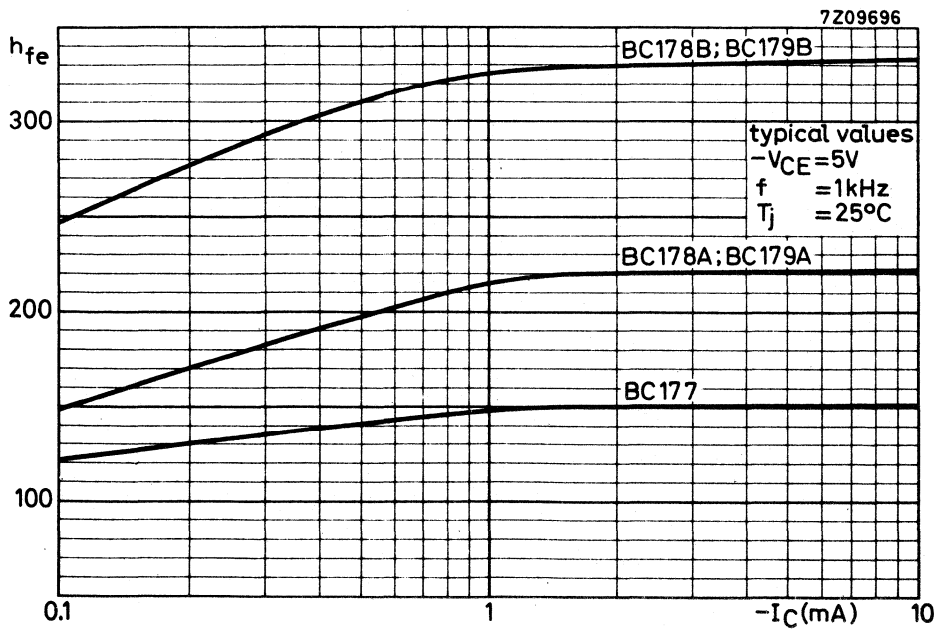

Fig. 16.

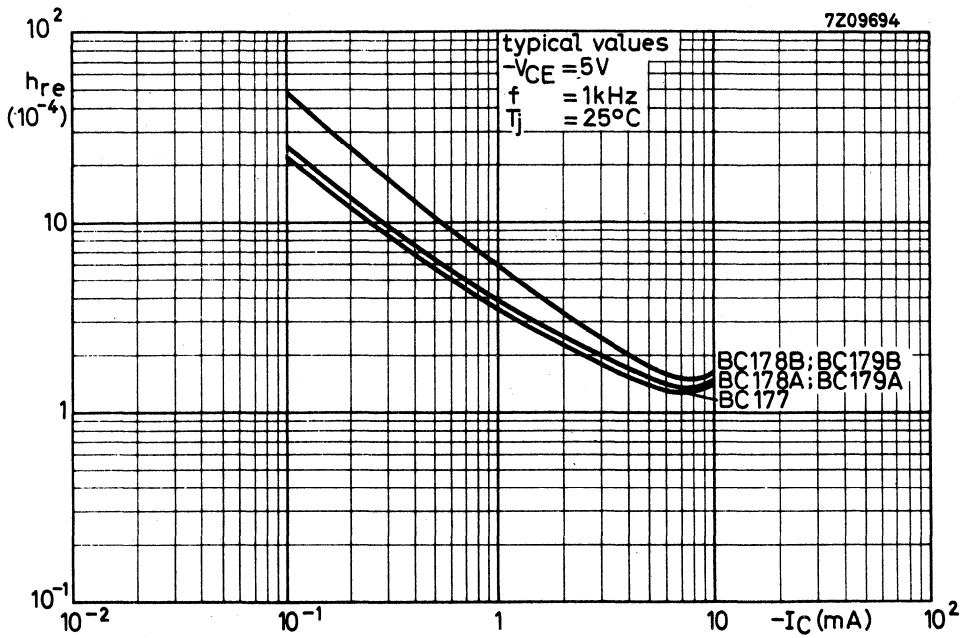

Fig. 17.

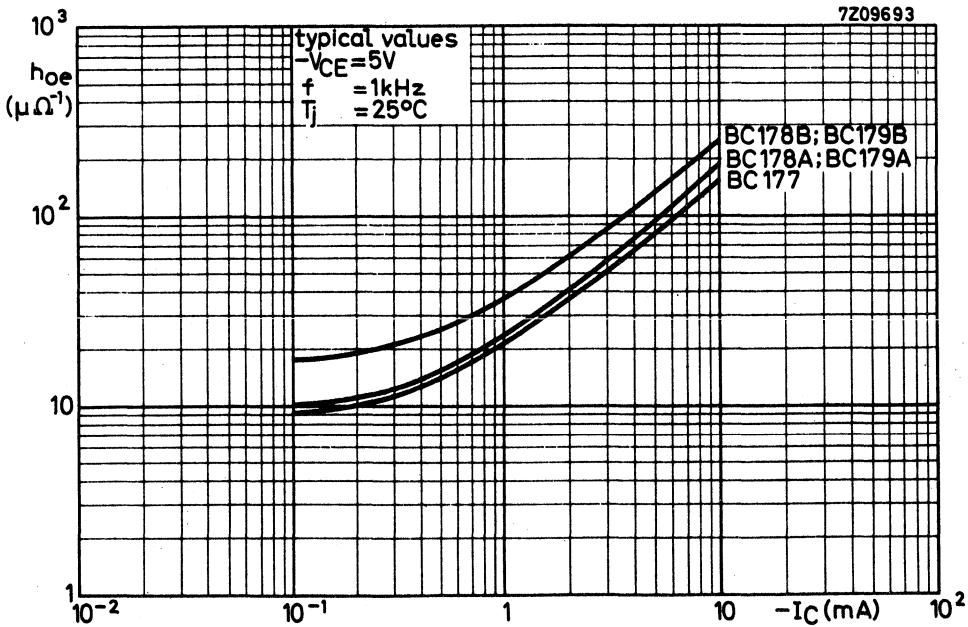

Fig. 18.

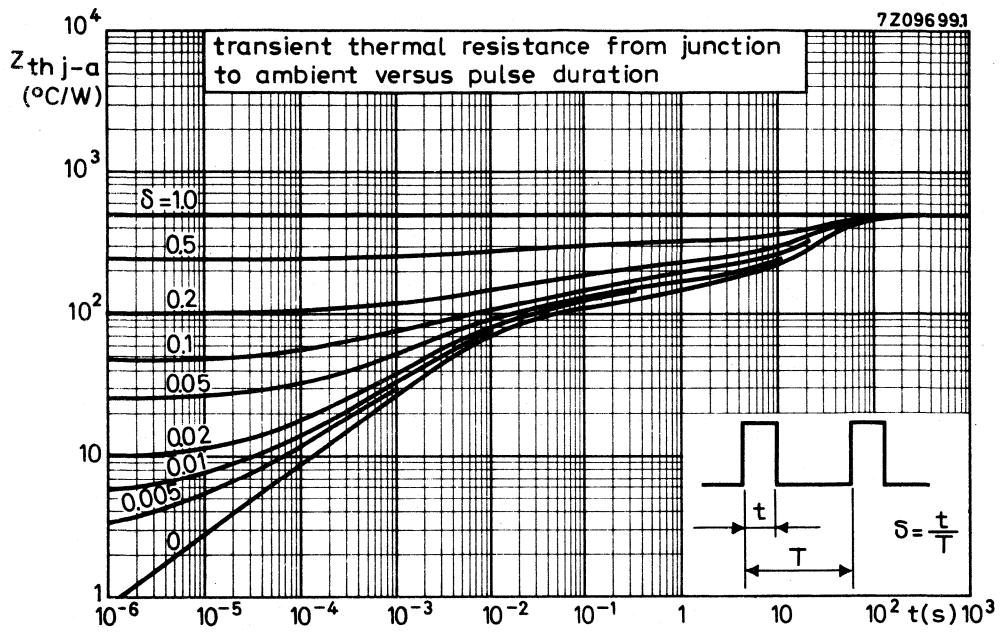

Fig. 19.







## SILICON PLANAR EPITAXIAL TRANSISTORS

P-N-P transistors in plastic TO-92 envelopes, primarily intended for use in driver and output stages of audio amplifiers.

The BC327, BC327A, BC328 are complementary to the BC337, BC337A and BC338 respectively.

### QUICK REFERENCE DATA

		BC327	BC327A	BC328	
Collector-emitter voltage ( $V_{BE} = 0$ )	$-V_{CES}$ max.	50	60	30	V
Collector-emitter voltage (open base)	$-V_{CEO}$ max.	45	60	25	V
Collector current (peak value)	$-I_{CM}$ max.	1000			mA
Total power dissipation up to $T_{amb} = 25\text{ }^{\circ}\text{C}$	$P_{tot}$ max.	800			mW
Junction temperature	$T_j$ max.	150			$^{\circ}\text{C}$
Transition frequency at $f = 35\text{ MHz}$ $-I_C = 10\text{ mA}; -V_{CE} = 5\text{ V}$	$f_T$ typ.	100			MHz
D.C. current gain $-I_C = 100\text{ mA}; -V_{CE} = 1\text{ V}$	$h_{FE}$	100 to 600			

### MECHANICAL DATA

Dimensions in mm

Fig. 1 TO-92.

#### Pinning

- 1 = emitter
- 2 = base
- 3 = collector

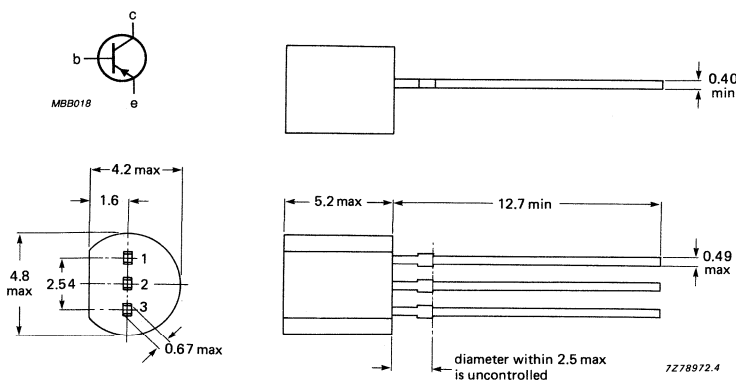

**RATINGS**

Limiting values in accordance with the Absolute Maximum System (IEC 134)

		BC327	BC327A	BC328	
Collector-emitter voltage ( $V_{BE} = 0$ )	$-V_{CES}$ max.	50	60	30	V
Collector-emitter voltage (open base) $-I_C = 10$ mA	$-V_{CEO}$ max.	45	60	25	V
Emitter-base voltage (open collector)	$-V_{EBO}$ max.	5	5	5	V
Collector current (d.c.)	$-I_C$ max.	500			mA
Collector current (peak value)	$-I_{CM}$ max.	1000			mA
Emitter current (peak value)	$I_{EM}$ max.	1000			mA
Base current (d.c.)	$-I_B$ max.	100			mA
Base current (peak value)	$-I_{BM}$ max.	200			mA
Total power dissipation at $T_{amb} = 25$ °C	$P_{tot}$ max.	625			mW
up to $T_{amb} = 25$ °C	$P_{tot}$ max.	800			mW*
Storage temperature	$T_{stg}$	-65 to +150			°C
Junction temperature	$T_j$ max.	150			°C

**THERMAL RESISTANCE**

From junction to ambient in free air	$R_{th\ j-a}$ =	0,2	K/mW
From junction to ambient	$R_{th\ j-a}$ =	0,156	K/mW*

\* Transistor mounted on printed circuit board, max. lead length 4 mm, mounting pad for collector lead min. 10 mm x 10 mm.

## CHARACTERISTICS

$T_j = 25\text{ }^\circ\text{C}$  unless otherwise specified

Collector cut-off current

$I_E = 0; -V_{CB} = 20\text{ V}; T_j = 25\text{ }^\circ\text{C}$

$-I_{CBO} < 100\text{ nA}$

$I_E = 0; -V_{CB} = 20\text{ V}; T_j = 150\text{ }^\circ\text{C}$

$-I_{CBO} < 5\text{ }\mu\text{A}$

Emitter cut-off current

$I_C = 0; -V_{EB} = 5\text{ V}$

$-I_{EBO} < 10\text{ }\mu\text{A}$

Base-emitter voltage\*

$-I_C = 500\text{ mA}; -V_{CE} = 1\text{ V}$

$-V_{BE} < 1,2\text{ V}$

Saturation voltage

$-I_C = 500\text{ mA}; -I_B = 50\text{ mA}$

$-V_{CEsat} < 700\text{ mV}$

D.C. current gain

$-I_C = 500\text{ mA}; -V_{CE} = 1\text{ V}$

$h_{FE} > 40$

$-I_C = 100\text{ mA}; -V_{CE} = 1\text{ V}; \text{BC327; BC328}$

$h_{FE} \text{ 100 to 600}$

BC327A

$h_{FE} \text{ 100 to 400}$

BC327-16 }

$h_{FE} \text{ 100 to 250}$

BC328-16 }

BC327-25 }

$h_{FE} \text{ 160 to 400}$

BC328-25 }

BC327-40 }

$h_{FE} \text{ 250 to 600}$

BC328-40 }

Transition frequency at  $f = 35\text{ MHz}$

$-I_C = 10\text{ mA}; -V_{CE} = 5\text{ V}$

$f_T \text{ typ. 100 MHz}$

Collector capacitance at  $f = 1\text{ MHz}$

$I_E = I_e = 0; -V_{CB} = 10\text{ V}$

$C_C \text{ typ. 8 pF}$

\*  $-V_{BE}$  decreases by about  $2\text{ mV/K}$  with increasing temperature.

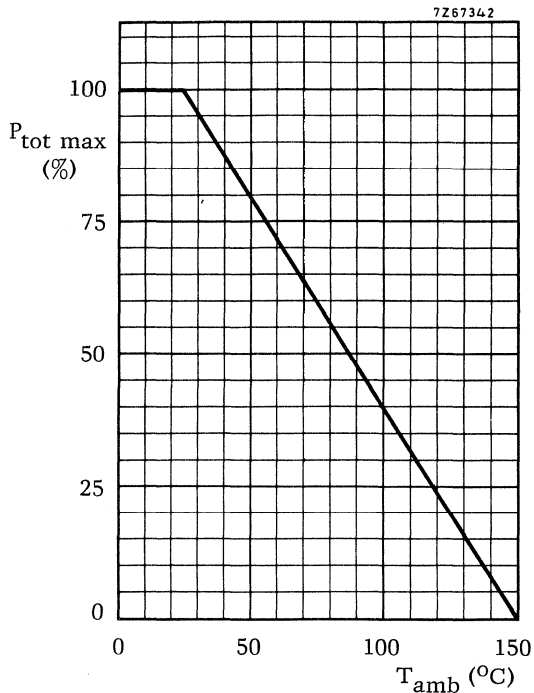

Fig. 2.

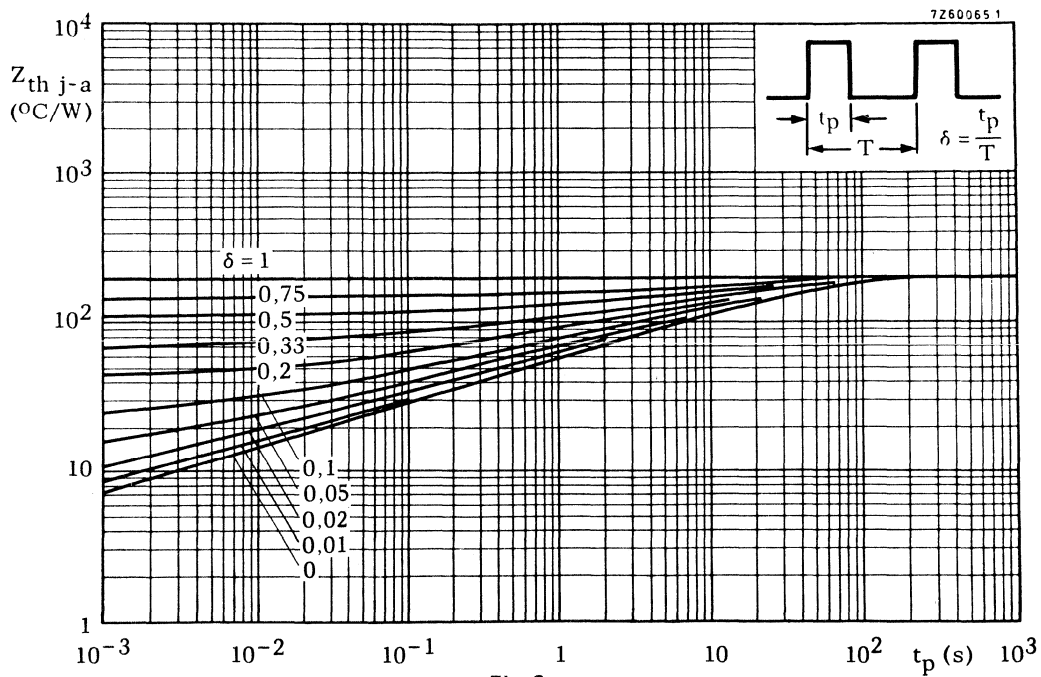

Fig. 3.

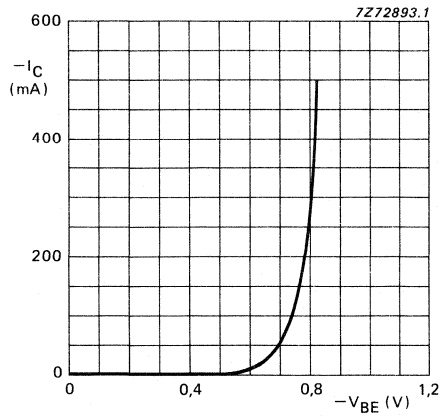

Fig. 4  $-V_{CE} = 1\text{ V}$ ;  $T_j = 25\text{ }^\circ\text{C}$ ; typical values.

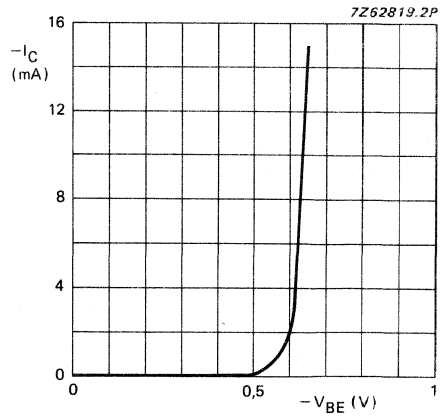

Fig. 5  $-V_{CE} = 5\text{ V}$ ;  $T_j = 25\text{ }^\circ\text{C}$ ; typical values.

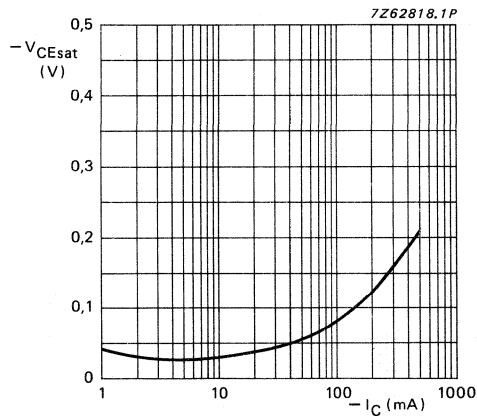

Fig. 6  $I_C/I_B = 10$ ;  $T_j = 25\text{ }^\circ\text{C}$ ; typical values.

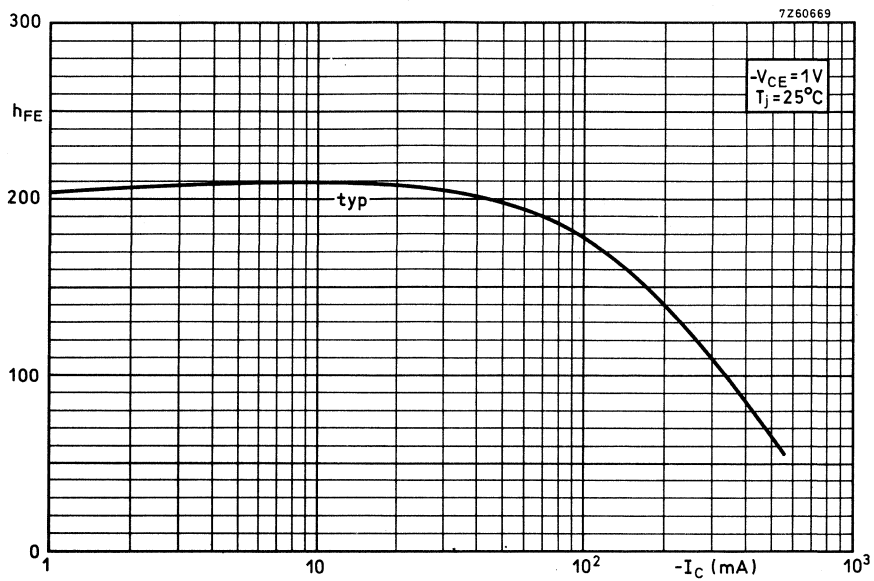

Fig. 7.

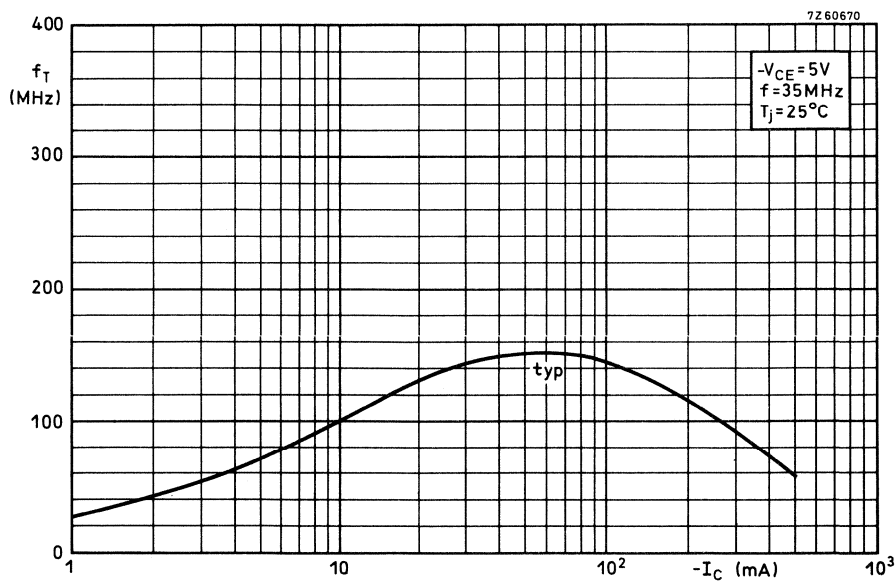

Fig. 8.



## SILICON PLANAR EPITAXIAL TRANSISTORS

N-P-N transistors in plastic TO-92 envelopes, primarily intended for use in driver and output stages of audio amplifiers.

The BC337, BC337A, BC338 are complementary to the BC327, BC327A and BC328 respectively.

### QUICK REFERENCE DATA

		BC337	BC337A	BC338	
Collector-emitter voltage ( $V_{BE} = 0$ )	$V_{CES}$	max. 50	60	30	V
Collector-emitter voltage (open base)	$V_{CEO}$	max. 45	60	25	V
Collector current (peak value)	$I_{CM}$	max. 1000			mA
Total power dissipation up to $T_{amb} = 25\text{ }^\circ\text{C}$	$P_{tot}$	max. 800			mW
Junction temperature	$T_j$	max. 150			$^\circ\text{C}$
Transition frequency at $f = 35\text{ MHz}$	$f_T$	typ. 100			MHz
D.C. current gain	$h_{FE}$	100 to 600			
$I_C = 10\text{ mA}; V_{CE} = 5\text{ V}$					
$I_C = 100\text{ mA}; V_{CE} = 1\text{ V}$					

### MECHANICAL DATA

Dimensions in mm

Fig. 1 TO-92.

#### Pinning

- 1 = emitter
- 2 = base
- 3 = collector

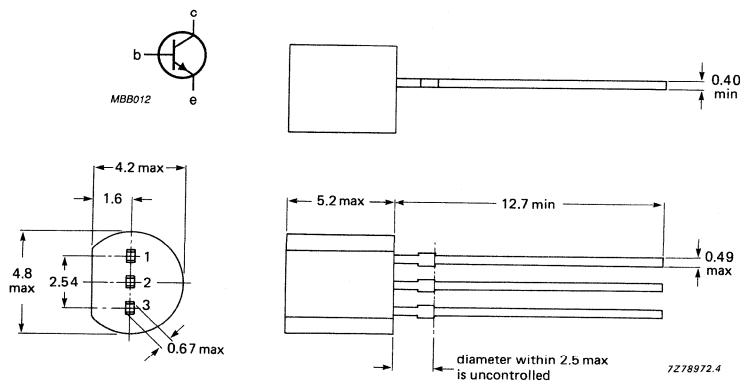

**RATINGS**

Limiting values in accordance with the Absolute Maximum System (IEC 134)

		BC337	BC337A	BC338	
Collector-emitter voltage ( $V_{BE} = 0$ )	$V_{CES}$	max. 50	60	30	V
Collector-emitter voltage (open base) $I_C = 10$ mA	$V_{CEO}$	max. 45	60	25	V
Emitter-base voltage (open collector)	$V_{EBO}$	max. 5	5	5	V
Collector current (d.c.)	$I_C$	max.	500		mA
Collector current (peak value)	$I_{CM}$	max.	1000		mA
Emitter current (peak value)	$-I_{EM}$	max.	1000		mA
Base current (d.c.)	$I_B$	max.	100		mA
Base current (peak value)	$I_{BM}$	max.	200		mA
Total power dissipation at $T_{amb} = 25$ °C	$P_{tot}$	max.	625		mW
up to $T_{amb} = 25$ °C	$P_{tot}$	max.	800		mW*
Storage temperature	$T_{stg}$		-65 to +150		°C
Junction temperature	$T_j$	max.	150		°C

**THERMAL RESISTANCE**

From junction to ambient in free air	$R_{th\ j-a}$	=	0,2		K/mW
From junction to ambient	$R_{th\ j-a}$	=	0,156		K/mW*

\* Transistor mounted on printed circuit board, max. lead length 4 mm, mounting pad for collector lead min. 10 mm x 10 mm.



**CHARACTERISTICS** $T_j = 25\text{ }^\circ\text{C}$  unless otherwise specified

Collector cut-off current

 $I_E = 0; V_{CB} = 20\text{ V}; T_j = 25\text{ }^\circ\text{C}$  $I_{CBO} < 100\text{ nA}$  $I_E = 0; V_{CB} = 20\text{ V}; T_j = 150\text{ }^\circ\text{C}$  $I_{CBO} < 5\text{ }\mu\text{A}$ 

Emitter cut-off current

 $I_C = 0; V_{EB} = 5\text{ V}$  $I_{EBO} < 10\text{ }\mu\text{A}$ 

Base-emitter voltage\*

 $I_C = 500\text{ mA}; V_{CE} = 1\text{ V}$  $V_{BE} < 1,2\text{ V}$ 

Saturation voltage

 $I_C = 500\text{ mA}; I_B = 50\text{ mA}$  $V_{CEsat} < 700\text{ mV}$ 

D.C. current gain

 $I_C = 500\text{ mA}; V_{CE} = 1\text{ V}$  $h_{FE} > 40$  $I_C = 100\text{ mA}; V_{CE} = 1\text{ V}; \text{BC337; BC338}$  $h_{FE} 100\text{ to }600$ 

BC337A

 $h_{FE} 100\text{ to }400$ 

BC337-16 }

 $h_{FE} 100\text{ to }250$ 

BC338-16 }

BC337-25 }

 $h_{FE} 160\text{ to }400$ 

BC338-25 }

BC337-40 }

 $h_{FE} 250\text{ to }600$ 

BC338-40 }

Transition frequency at  $f = 35\text{ MHz}$  $I_C = 10\text{ mA}; V_{CE} = 5\text{ V}$  $f_T$  typ. 100 MHzCollector capacitance at  $f = 1\text{ MHz}$  $I_E = I_e = 0; V_{CB} = 10\text{ V}$  $C_C$  typ. 5 pF\*  $V_{BE}$  decreases by about 2 mV/K with increasing temperature.

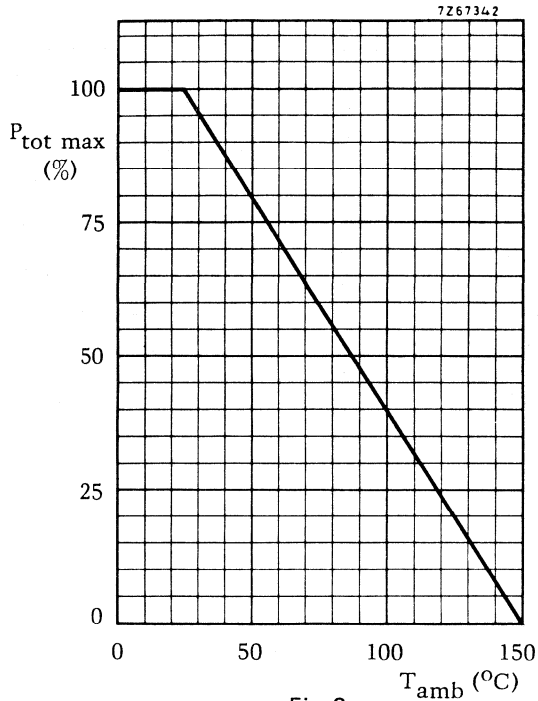

Fig. 2.

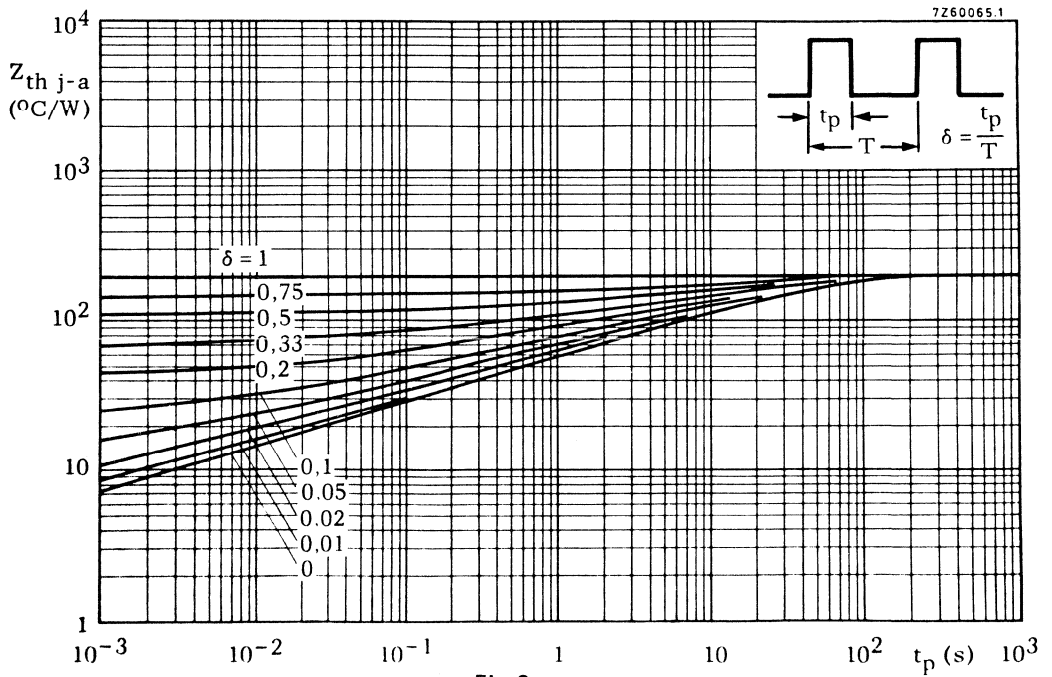

Fig. 3.

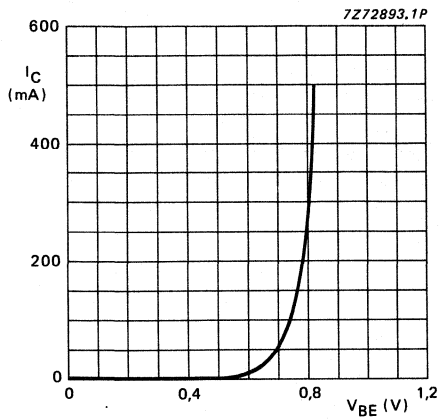

Fig. 4  $V_{CE} = 1 \text{ V}$ ;  $T_j = 25 \text{ }^\circ\text{C}$ ; typical values.

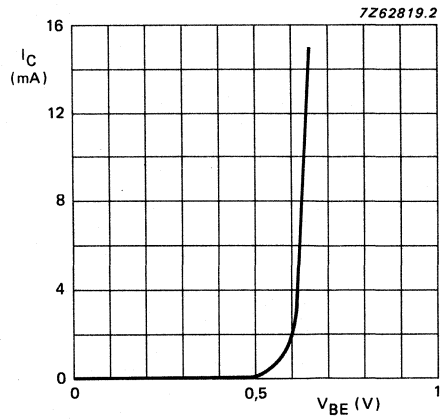

Fig. 5  $V_{CE} = 5 \text{ V}$ ;  $T_j = 25 \text{ }^\circ\text{C}$ ; typical values.

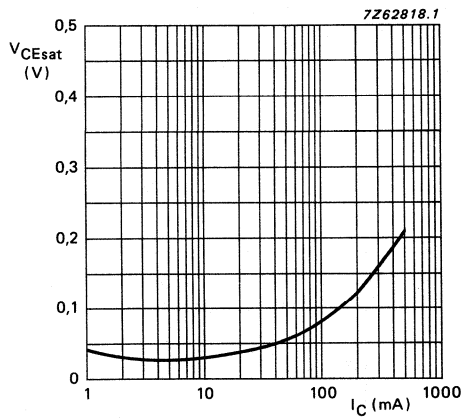

Fig. 6  $I_C/I_B = 10$ ;  $T_j = 25 \text{ }^\circ\text{C}$ ; typical values.

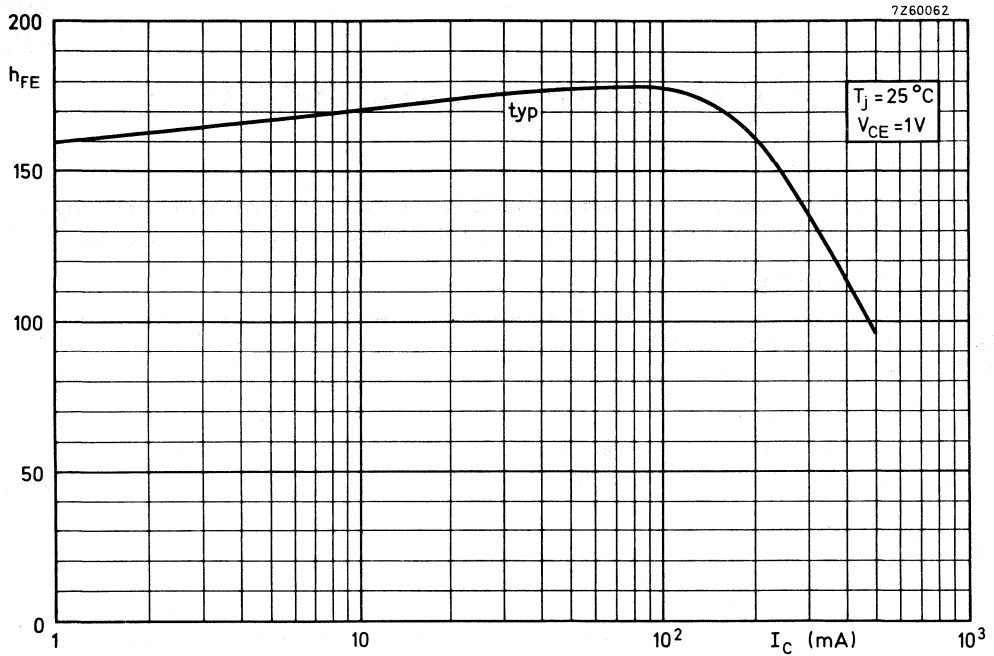

Fig. 7.

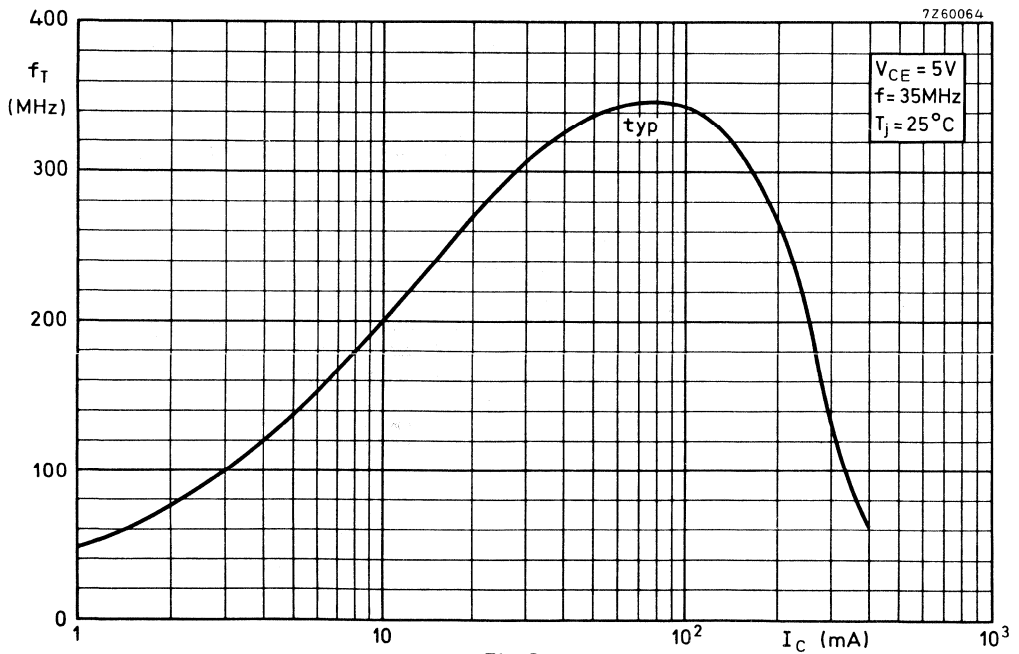

Fig. 8.

APPLICATION INFORMATION, see BC327; BC328.



## SILICON PLANAR EPITAXIAL TRANSISTOR

NPN transistor in a plastic TO-92 envelope, intended for low-voltage, high current LF applications. BC368/BC369 is the matched complementary pair suitable for class-B audio output stages up to 3 W.

### QUICK REFERENCE DATA

Collector-emitter voltage ( $V_{BE} = 0$ )	$V_{CES}$	max.	25 V
Collector-emitter voltage (open base)	$V_{CEO}$	max.	20 V
Collector current (peak value)	$I_{CM}$	max.	2 A
Total power dissipation up to $T_{amb} = 25\text{ }^{\circ}\text{C}$	$P_{tot}$	max.	1 W
Junction temperature	$T_j$	max.	150 $^{\circ}\text{C}$
DC current gain $I_C = 500\text{ mA}; V_{CE} = 1\text{ V}$	$h_{FE}$		85 to 375
Transition frequency at $f = 35\text{ MHz}$ $I_C = 10\text{ mA}; V_{CE} = 5\text{ V}$	$f_T$	min.	40 MHz

### MECHANICAL DATA

Dimensions in mm

Fig. 1 TO-92.

#### Pinning

- 1 = base
- 2 = collector
- 3 = emitter

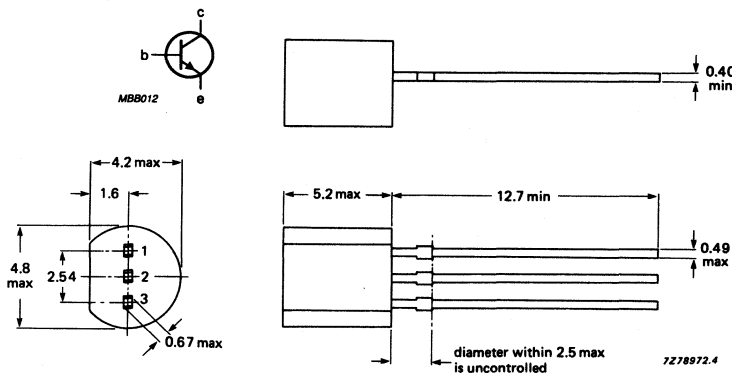

**RATINGS**

Limiting values in accordance with the Absolute Maximum System (IEC 134)

Collector-emitter voltage ( $V_{BE} = 0$ )	$V_{CES}$	max.	25 V
Collector-emitter voltage (open base)	$V_{CEO}$	max.	20 V
Emitter-base voltage (open collector)	$V_{EBO}$	max.	5 V
Collector current (DC)	$I_C$	max.	1 A
Collector current (peak value)	$I_{CM}$	max.	2 A
Base current (DC)	$I_B$	max.	100 mA
Base current (peak value)	$I_{BM}$	max.	200 mA
Total power dissipation	$P_{tot}$	max.	0,8 W
at $T_{amb} = 25\text{ °C}$ (in free air)	$P_{tot}$	max.	1 W
up to $T_{amb} = 25\text{ °C}$ *			
Storage temperature range	$T_{stg}$		-65 to + 150 °C
Junction temperature	$T_j$	max.	150 °C

**THERMAL RESISTANCE**

From junction to ambient in free air	$R_{th\ j-a}$	=	156 K/W
From junction to ambient*	$R_{th\ j-a}$	=	125 K/W
From junction to case	$R_{th\ j-c}$	=	60 K/W

\* Transistor mounted on printed-circuit board, maximum lead length 4 mm, mounting pad for collector lead min. 10 mm x 10 mm.

**CHARACTERISTICS**

$T_j = 25\text{ }^\circ\text{C}$  unless otherwise specified

Collector cut-off current

$I_E = 0; V_{CB} = 25\text{ V}$

$I_E = 0; V_{CB} = 25\text{ V}; T_j = 150\text{ }^\circ\text{C}$

$I_{CBO}$	max.	10 $\mu\text{A}$
$I_{CBO}$	max.	1 mA

Emitter cut-off current

$I_C = 0; V_{EB} = 5\text{ V}$

$I_{EBO}$	max.	10 $\mu\text{A}$
-----------	------	------------------

Base-emitter voltage

$I_C = 5\text{ mA}; V_{CE} = 10\text{ V}$

$I_C = 1\text{ A}; V_{CE} = 1\text{ V}$

$V_{BE}$	max.	0.7 V
$V_{BE}$	max.	1 V

Collector-emitter saturation voltage

$I_C = 1\text{ A}; I_B = 100\text{ mA}$

$V_{CEsat}$	max.	0.5 V
-------------	------	-------

DC current gain

$I_C = 5\text{ mA}; V_{CE} = 10\text{ V}$

$I_C = 500\text{ mA}; V_{CE} = 1\text{ V}$

$I_C = 1\text{ A}; V_{CE} = 1\text{ V}$

$h_{FE}$	min.	50
$h_{FE}$		85 to 375
$h_{FE}$	min.	60

Collector capacitance at  $f = 450\text{ kHz}$

$I_E = I_e = 0; V_{CB} = 5\text{ V}$

$C_C$	max.	40 pF
-------	------	-------

Transition frequency at  $f = 35\text{ MHz}$

$I_C = 10\text{ mA}; V_{CE} = 5\text{ V}$

$f_T$	min.	40 MHz
-------	------	--------

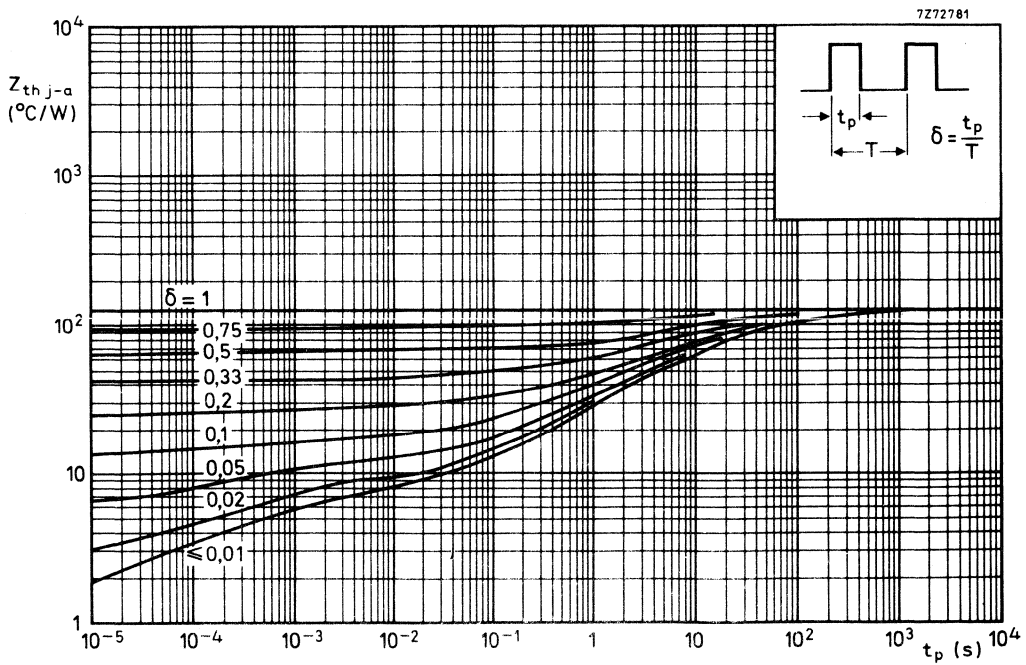
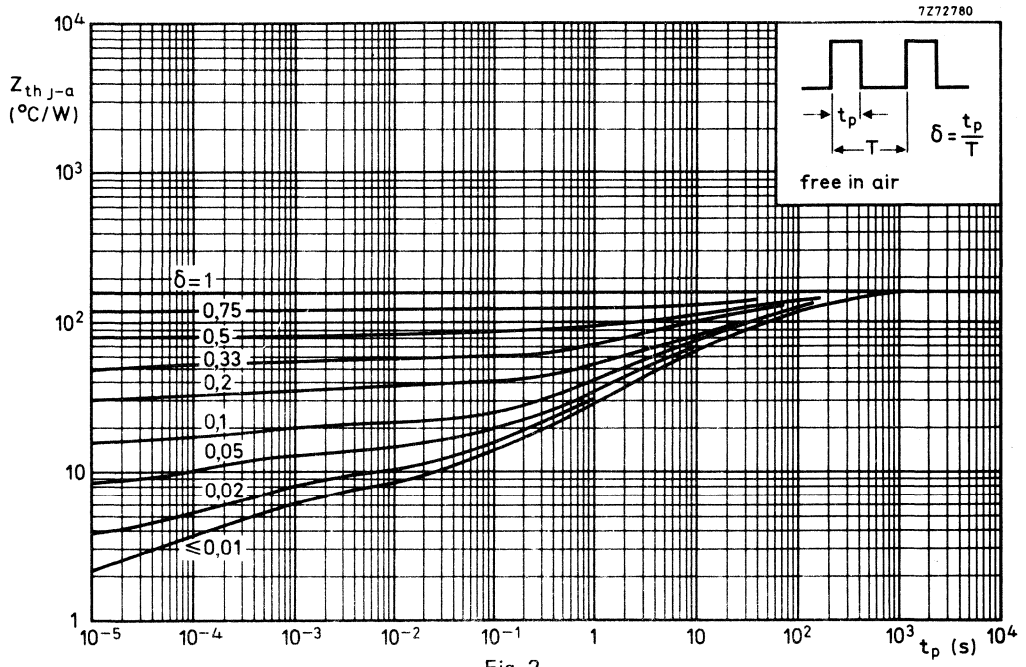



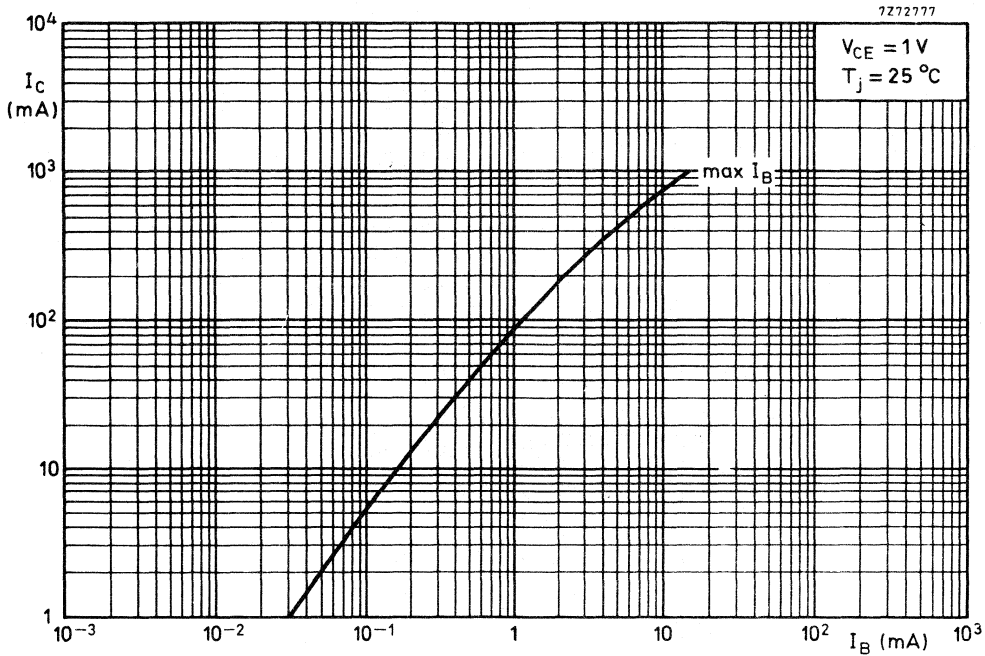

Fig. 4.

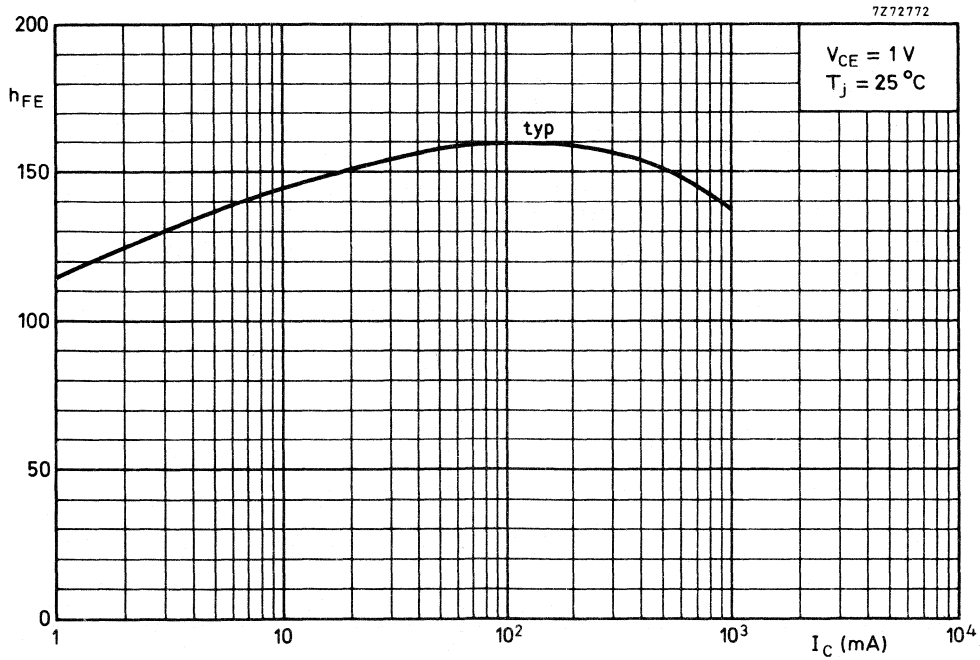

Fig. 5.

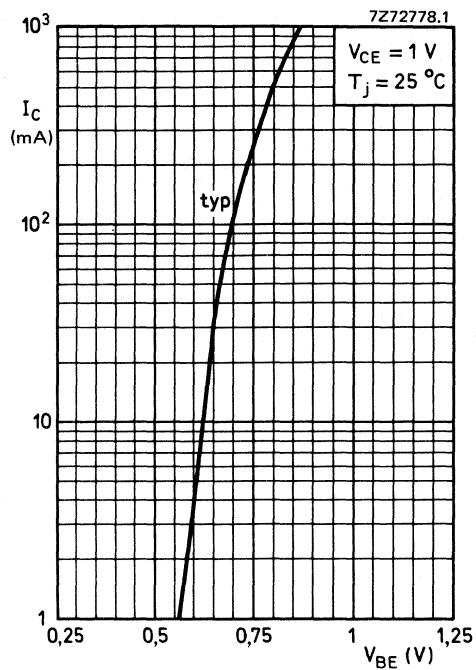

Fig. 6.

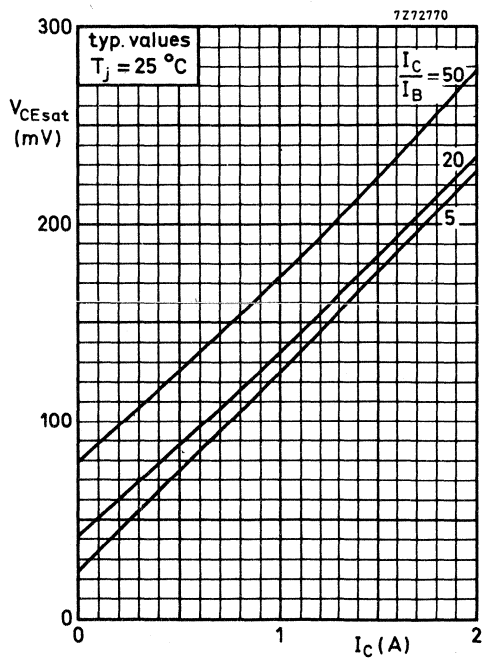

Fig. 7.

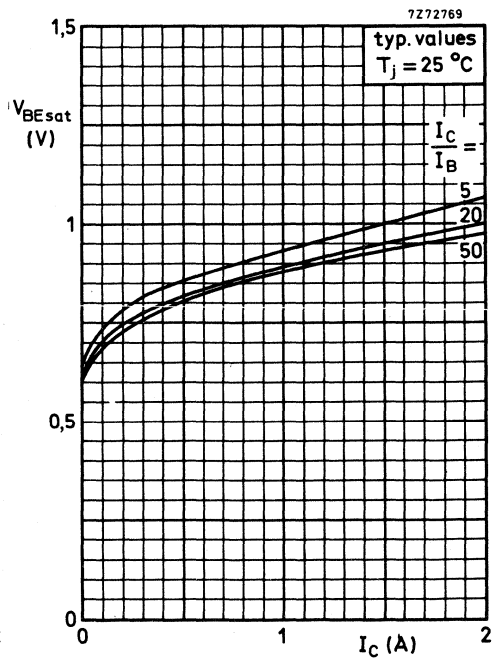

Fig. 8.

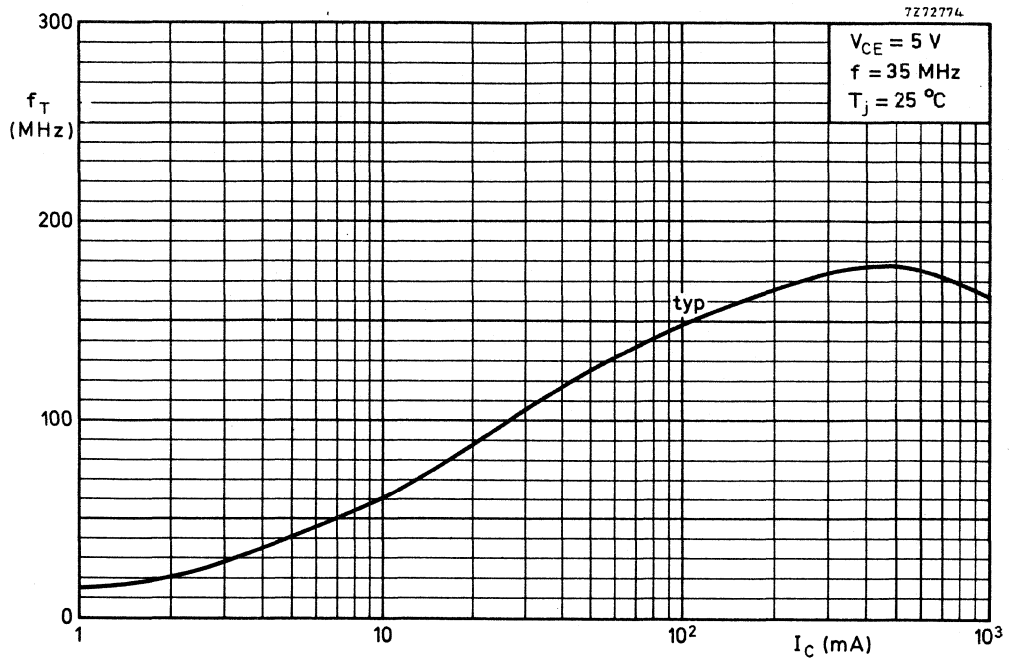

Fig. 9.





## SILICON PLANAR EPITAXIAL TRANSISTOR

PNP transistor in a plastic TO-92 envelope, intended for low-voltage, high-current LF applications. BC368/BC369 is the matched complementary pair suitable for class-B output stages up to 3 W.

### QUICK REFERENCE DATA

Collector-emitter voltage ( $V_{BE} = 0$ )	$-V_{CES}$ max.	25 V
Collector-emitter voltage (open base)	$-V_{CEO}$ max.	20 V
Collector current (peak value)	$-I_{CM}$ max.	2 A
Total power dissipation up to $T_{amb} = 25\text{ }^{\circ}\text{C}$	$P_{tot}$ max.	1 W
Junction temperature	$T_j$ max.	150 $^{\circ}\text{C}$
DC current gain $-I_C = 500\text{ mA}; -V_{CE} = 1\text{ V}$	$h_{FE}$	85 to 375
Transition frequency at $f = 35\text{ MHz}$ $-I_C = 10\text{ mA}; -V_{CE} = 5\text{ V}$	$f_T$ min.	40 MHz

### MECHANICAL DATA

Dimensions in mm

Fig. 1 TO-92.

#### Pinning

- 1 = base
- 2 = collector
- 3 = emitter

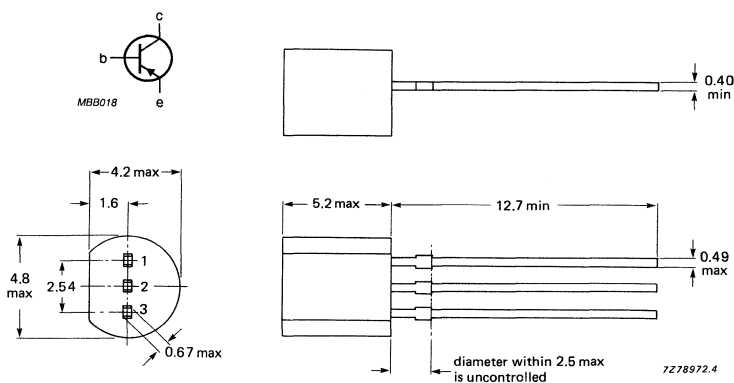

**RATINGS**

Limiting values in accordance with the Absolute Maximum System (IEC 134)

Collector-emitter voltage ( $V_{BE} = 0$ )	$-V_{CES}$	max.	25 V
Collector-emitter voltage (open base)	$-V_{CEO}$	max.	20 V
Emitter-base voltage (open collector)	$-V_{EBO}$	max.	5 V
Collector current (DC)	$-I_C$	max.	1 A
Collector current (peak value)	$-I_{CM}$	max.	2 A
Base current (DC)	$-I_B$	max.	100 mA
Base current (peak value)	$-I_{BM}$	max.	200 mA
Total power dissipation			
at $T_{amb} = 25\text{ °C}$ (in free air)	$P_{tot}$	max.	0,8 W
up to $T_{amb} = 25\text{ °C}^*$	$P_{tot}$	max.	1 W
Storage temperature range	$T_{stg}$		-65 to + 150 °C
Junction temperature	$T_j$	max.	150 °C

**THERMAL RESISTANCE**

From junction to ambient in free air	$R_{th\ j-a}$	=	156 K/W
From junction to ambient*	$R_{th\ j-a}$	=	125 K/W
From junction to case	$R_{th\ j-c}$	=	60 K/W

\* Transistor mounted on printed-circuit board, maximum lead length 4 mm, mounting pad for collector lead min. 10 mm x 10 mm.

**CHARACTERISTICS**

$T_j = 25\text{ }^\circ\text{C}$  unless otherwise specified

Collector cut-off current

$$I_E = 0; -V_{CB} = 25\text{ V}$$

$$I_E = 0; -V_{CB} = 25\text{ V}; T_j = 150\text{ }^\circ\text{C}$$

$$-I_{CBO} \quad \text{max.} \quad 10\text{ }\mu\text{A}$$

$$-I_{CBO} \quad \text{max.} \quad 1\text{ mA}$$

Emitter cut-off current

$$I_C = 0; -V_{EB} = 5\text{ V}$$

$$-I_{EBO} \quad \text{max.} \quad 10\text{ }\mu\text{A}$$

Base-emitter voltage

$$-I_C = 5\text{ mA}; -V_{CE} = 10\text{ V}$$

$$-I_C = 1\text{ A}; -V_{CE} = 1\text{ V}$$

$$-V_{BE} \quad \text{max.} \quad 0.7\text{ V}$$

$$-V_{BE} \quad \text{max.} \quad 1\text{ V}$$

Collector-emitter saturation voltage

$$-I_C = 1\text{ A}; -I_B = 100\text{ mA}$$

$$-V_{CEsat} \quad \text{max.} \quad 0.5\text{ V}$$

DC current gain

$$-I_C = 5\text{ mA}; -V_{CE} = 10\text{ V}$$

$$-I_C = 500\text{ mA}; -V_{CE} = 1\text{ V}$$

$$-I_C = 1\text{ A}; -V_{CE} = 1\text{ V}$$

$$h_{FE} \quad \text{min.} \quad 50$$

$$h_{FE} \quad 85\text{ to }375$$

$$h_{FE} \quad \text{min.} \quad 60$$

Collector capacitance at  $f = 450\text{ kHz}$

$$I_E = I_e = 0; -V_{CB} = 5\text{ V}$$

$$C_c \quad \text{max.} \quad 60\text{ pF}$$

Transition frequency at  $f = 35\text{ MHz}$

$$-I_C = 10\text{ mA}; -V_{CE} = 5\text{ V}$$

$$f_T \quad \text{min.} \quad 40\text{ MHz}$$

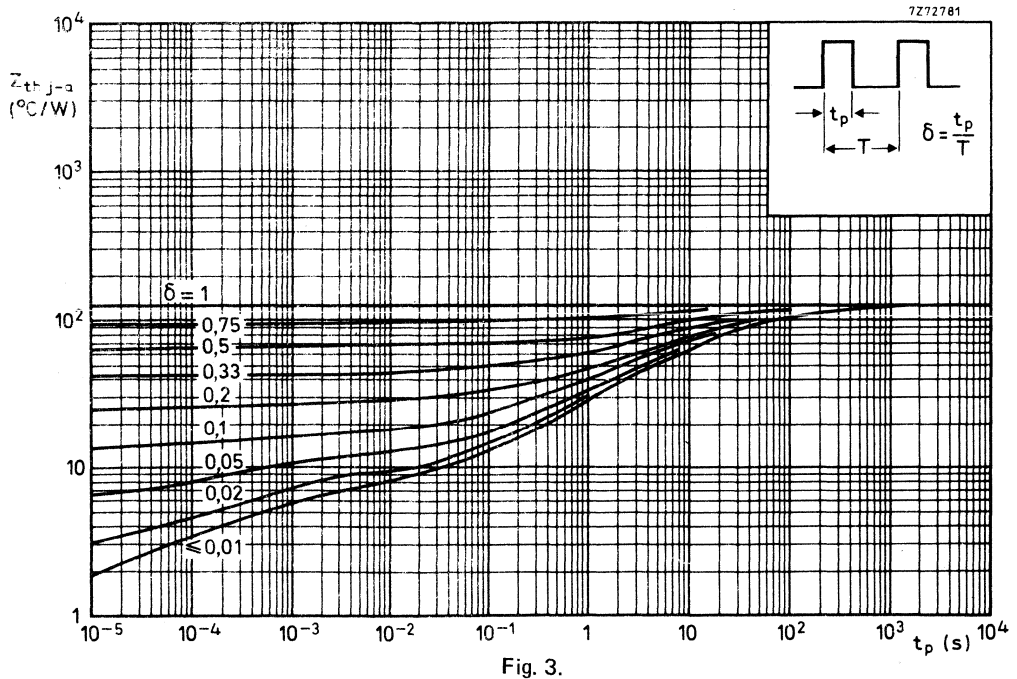
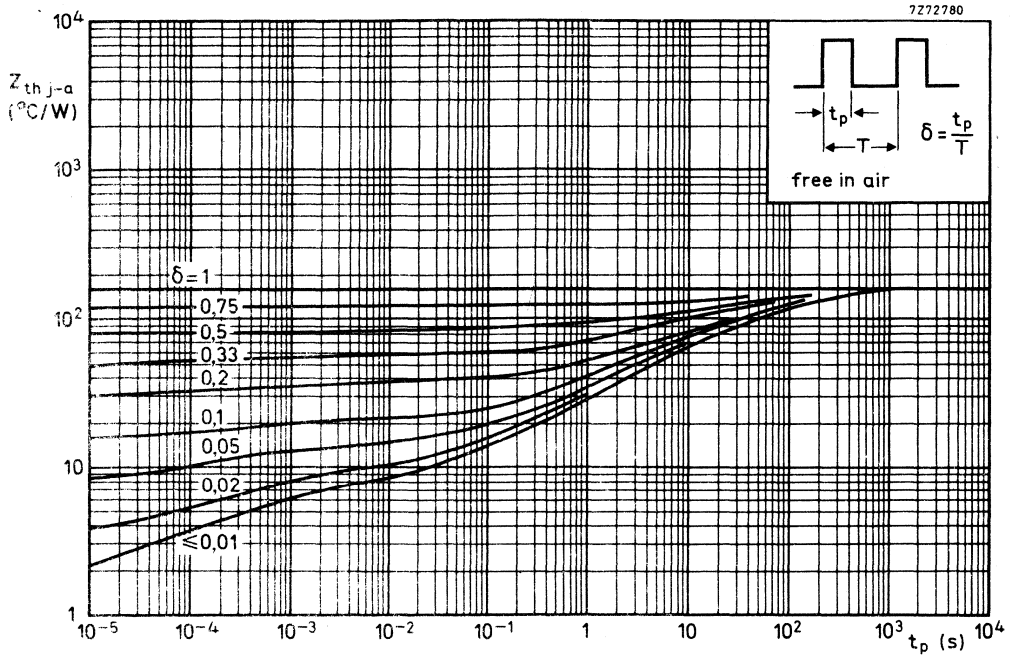



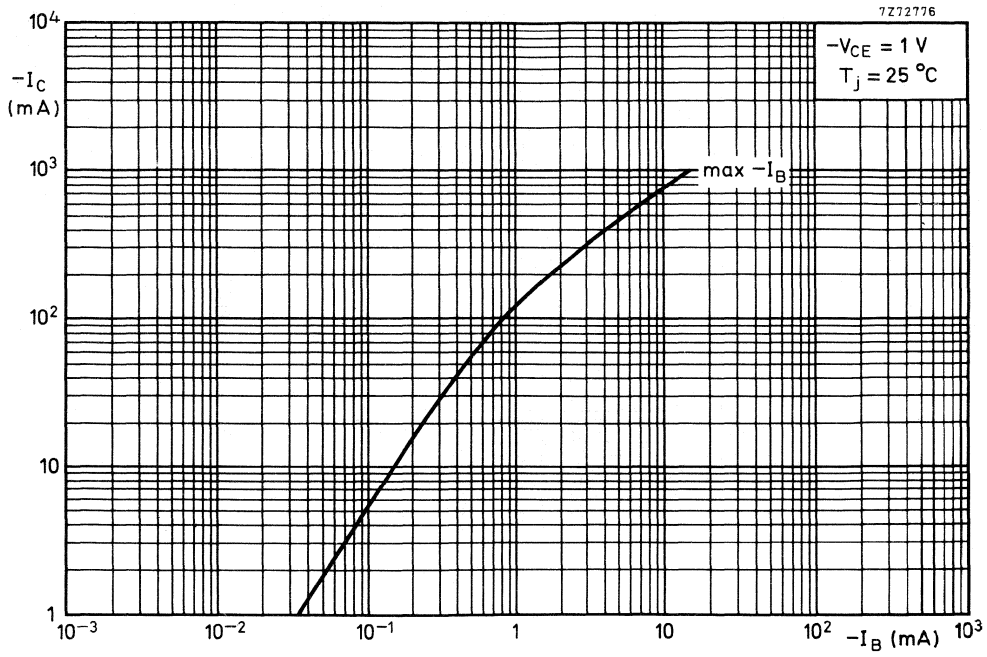

Fig. 4.

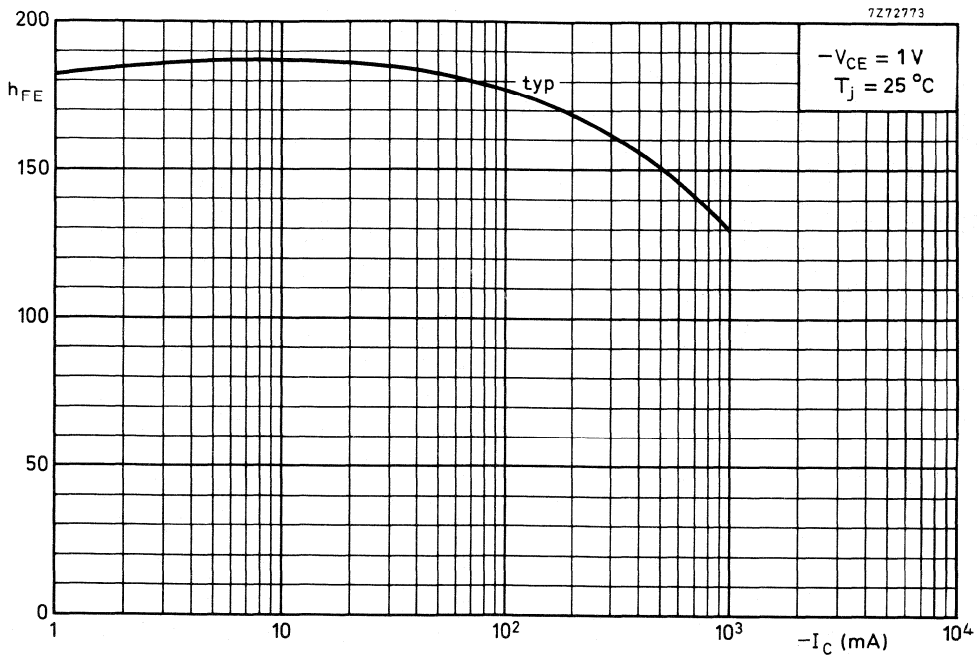

Fig. 5.

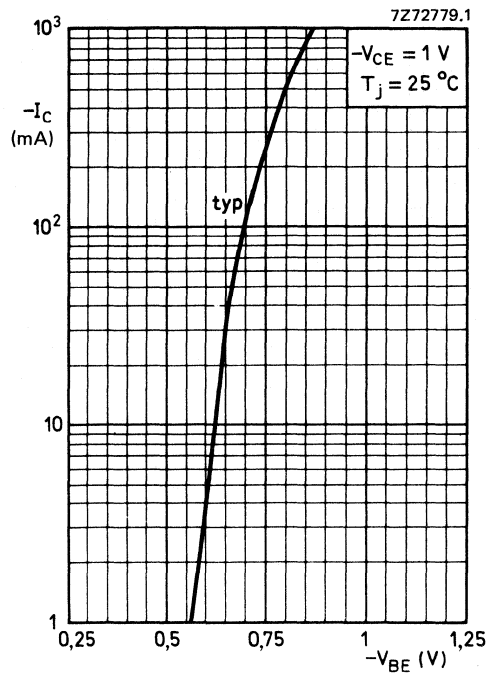

Fig. 6.

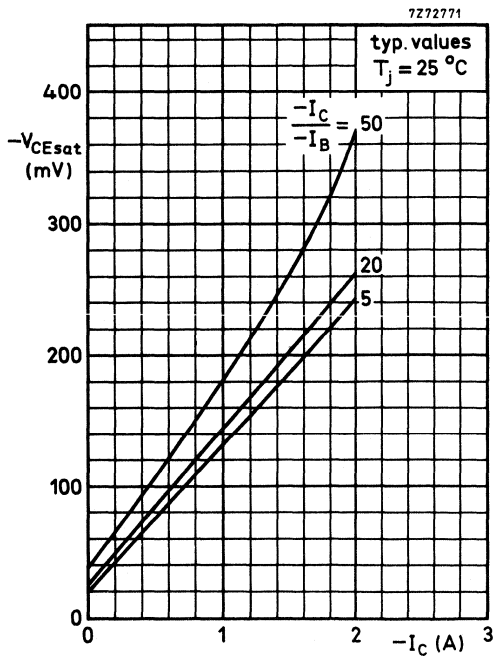

Fig. 7.

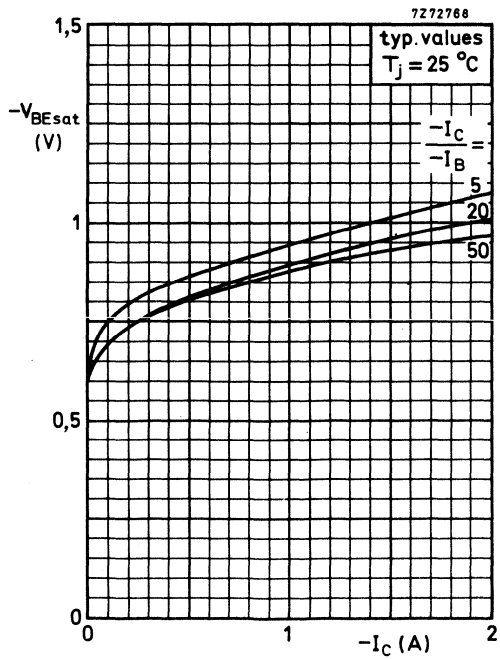

Fig. 8.

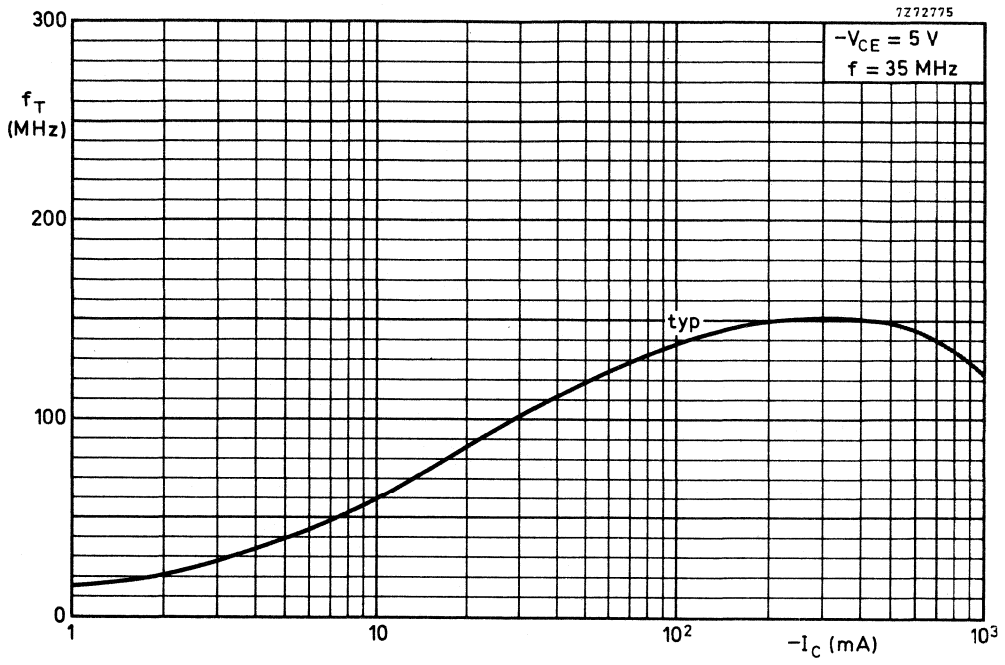

Fig. 9.





## SILICON PLANAR EPITAXIAL TRANSISTOR

NPN transistor in a plastic TO-92 envelope, intended for low-voltage, high-current LF applications. BC375/BC376 is the matched complementary pair suitable for output stages up to 2 W.

### QUICK REFERENCE DATA

Collector-base voltage (open emitter)	$V_{CBO}$	max.	30 V
Collector-emitter voltage (open base)	$V_{CEO}$	max.	30 V
Collector current (peak value)	$I_{CM}$	max.	1.5 A
Total power dissipation up to $T_{amb} = 25\text{ }^{\circ}\text{C}$	$P_{tot}$	max.	800 mW
Junction temperature	$T_j$	max.	150 $^{\circ}\text{C}$
DC current gain	$h_{FE}$		100 to 400
$I_C = 150\text{ mA}; V_{CE} = 1\text{ V}$			
Transition frequency at $f = 35\text{ MHz}$	$f_T$	typ.	150 MHz
$I_C = 150\text{ mA}; V_{CE} = 1\text{ V}$			

### MECHANICAL DATA

Dimensions in mm

Fig. 1 TO-92.

#### Pinning

- 1 = emitter
- 2 = base
- 3 = collector

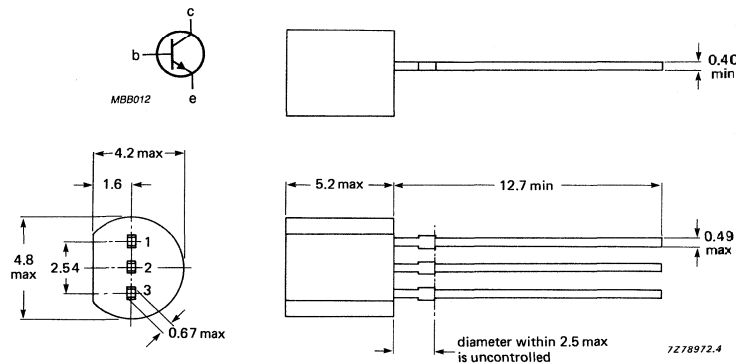

**RATINGS**

Limiting values in accordance with the Absolute Maximum System (IEC 134)

Collector-base voltage (open emitter)	$V_{CB0}$	max.	30 V
Collector-emitter voltage (open base)	$V_{CEO}$	max.	30 V
Emitter-base voltage (open collector)	$V_{EBO}$	max.	6 V
Collector current (DC)	$I_C$	max.	1 A
Collector current (peak value)	$I_{CM}$	max.	1,5 A
Base current (DC)	$I_B$	max.	100 mA
Base current (peak value)	$I_{BM}$	max.	200 mA
Total power dissipation at $T_{amb} = 25\text{ }^\circ\text{C}$ (in free air) up to $T_{amb} = 25\text{ }^\circ\text{C}^*$	$P_{tot}$ $P_{tot}$	max. max.	625 mW 800 mW
Storage temperature	$T_{stg}$		-65 to +150 $^\circ\text{C}$
Junction temperature	$T_j$	max.	150 $^\circ\text{C}$

**THERMAL RESISTANCE**

From junction to ambient in free air	$R_{th\ j-a}$	=	200 K/W
From junction to ambient *	$R_{th\ j-a}$	=	156 K/W
From junction to case	$R_{th\ j-c}$	=	95 K/W

**CHARACTERISTICS** $T_j = 25\text{ }^\circ\text{C}$  unless otherwise specified

Collector cut-off current $I_E = 0; V_{CB} = 25\text{ V}$ $I_E = 0; V_{CB} = 25\text{ V}; T_j = 150\text{ }^\circ\text{C}$	$I_{CB0}$ $I_{CB0}$	max. max.	100 nA 5 $\mu\text{A}$
Emitter cut-off current $I_C = 0; V_{EB} = 5\text{ V}$	$I_{EBO}$	max.	10 $\mu\text{A}$
Base-emitter voltage** $I_C = 5\text{ mA}; V_{CE} = 10\text{ V}$ $I_C = 700\text{ mA}; V_{CE} = 1\text{ V}$	$V_{BE}$ $V_{BE}$	typ. max.	650 mV 1.1 V
Collector-emitter saturation voltage $I_C = 700\text{ mA}; I_B = 70\text{ mA}$	$V_{CEsat}$	typ. max.	250 mV 400 mV
D.C. current gain $I_C = 5\text{ mA}; V_{CE} = 10\text{ V}$ $I_C = 150\text{ mA}; V_{CE} = 1\text{ V}$ $I_C = 700\text{ mA}; V_{CE} = 1\text{ V}$	$h_{FE}$ $h_{FE}$ $h_{FE}$	min. 100 to min.	100 400 50
Transition frequency at $f = 35\text{ MHz}$ $I_C = 150\text{ mA}; V_{CE} = 1\text{ V}$	$f_T$	typ.	150 MHz

\* Transistor mounted on printed-circuit board, maximum lead length 4 mm, mounting pad for collector lead minimum 10 mm x 10 mm.

\*\*  $V_{BE}$  decreases by about 2 mV/K with increasing temperature.



## SILICON PLANAR EPITAXIAL TRANSISTOR

PNP transistor in a plastic TO-92, intended for low-voltage, high-current LF applications. BC375/BC376 is the matched complementary pair suitable for output stages up to 2 W.

### QUICK REFERENCE DATA

Collector-base voltage (open emitter)	$-V_{CBO}$	max.	25 V
Collector-emitter voltage (open base)	$-V_{CEO}$	max.	20 V
Collector current (peak value)	$-I_{CM}$	max.	1.5 A
Total power dissipation up to $T_{amb} = 25\text{ }^{\circ}\text{C}$	$P_{tot}$	max.	800 mW
Junction temperature	$T_j$	max.	150 $^{\circ}\text{C}$
DC current gain	$h_{FE}$		100 to 400
$-I_C = 150\text{ mA}; -V_{CE} = 1\text{ V}$			
Transition frequency at $f = 35\text{ MHz}$	$f_T$	typ.	100 MHz
$-I_C = 150\text{ mA}; -V_{CE} = 1\text{ V}$			

### MECHANICAL DATA

Dimensions in mm

Fig. 1 TO-92.

#### Pinning

- 1 = emitter
- 2 = base
- 3 = collector

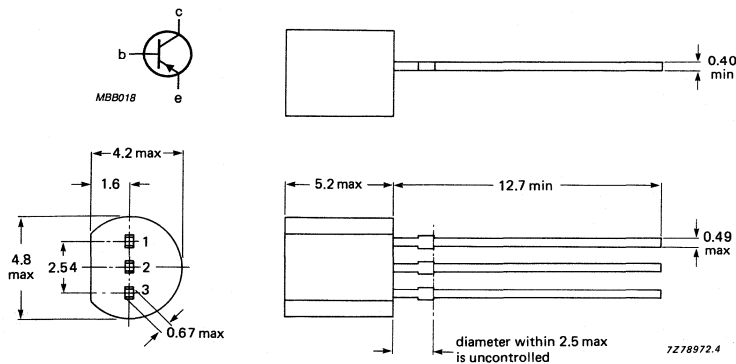

**RATINGS**

Limiting values in accordance with the Absolute Maximum System (IEC 134)

Collector-base voltage (open emitter)	$-V_{CBO}$	max.	25 V
Collector-emitter voltage (open base)	$-V_{CEO}$	max.	20 V
Emitter-base voltage (open collector)	$-V_{EBO}$	max.	6 V
Collector current (DC)	$-I_C$	max.	1 A
Collector current (peak value)	$-I_{CM}$	max.	1.5 A
Base current (DC)	$-I_B$	max.	100 mA
Base current (peak value)	$-I_{BM}$	max.	200 mA
Total power dissipation at $T_{amb} = 25\text{ }^\circ\text{C}$ (in free air)	$P_{tot}$	max.	625 mW
up to $T_{amb} = 25\text{ }^\circ\text{C}^*$	$P_{tot}$	max.	800 mW
Storage temperature range	$T_{stg}$		$-65$ to $+150\text{ }^\circ\text{C}$
Junction temperature	$T_j$	max.	150 $^\circ\text{C}$

**THERMAL RESISTANCE**

From junction to ambient in free air	$R_{th\ j-a}$	=	200 K/W
From junction to ambient*	$R_{th\ j-a}$	=	156 K/W
From junction to case	$R_{th\ j-c}$	=	95 K/W

**CHARACTERISTICS** $T_j = 25\text{ }^\circ\text{C}$  unless otherwise specified

Collector cut-off current $I_E = 0; -V_{CB} = 25\text{ V}$ $I_E = 0; -V_{CB} = 25\text{ V}; T_j = 150\text{ }^\circ\text{C}$	$-I_{CBO}$ $-I_{CBO}$	max. max.	100 nA 5 $\mu\text{A}$
Emitter cut-off current $I_C = 0; -V_{EB} = 5\text{ V}$	$-I_{EBO}$	max.	10 $\mu\text{A}$
Base-emitter voltage** $-I_C = 5\text{ mA}; -V_{CE} = 10\text{ V}$ $-I_C = 700\text{ mA}; -V_{CE} = 1\text{ V}$	$-V_{BE}$ $-V_{BE}$	typ. max.	650 mV 1.1 V
Collector-emitter saturation voltage $-I_C = 700\text{ mA}; -I_B = 70\text{ mA}$	$-V_{CEsat}$	typ. max.	280 mV 400 mV
DC current gain $-I_C = 5\text{ mA}; -V_{CE} = 10\text{ V}$ $-I_C = 150\text{ mA}; -V_{CE} = 1\text{ V}$ $-I_C = 700\text{ mA}; -V_{CE} = 1\text{ V}$	$h_{FE}$ $h_{FE}$ $h_{FE}$	min.  min.	100 100 to 400 50
Transition frequency at $f = 35\text{ MHz}$ $-I_C = 150\text{ mA}; -V_{CE} = 1\text{ V}$	$f_T$	typ.	100 MHz

\* Transistor mounted on printed-circuit board, maximum lead length 4 mm, mounting pad for collector lead minimum 10 mm x 10 mm.

\*\*  $-V_{BE}$  decreases by about 2 mV/K with increasing temperature.





## SILICON PLANAR DARLINGTON TRANSISTOR

P-N-P silicon planar darlington transistor in a plastic TO-92 envelope.

N-P-N complement is BC517.

### QUICK REFERENCE DATA

Collector-emitter voltage (open base)	$-V_{CEO}$	max.	30 V
Collector-base voltage (open emitter)	$-V_{CBO}$	max.	40 V
Collector current	$-I_C$	max.	400 mA
Junction temperature	$T_j$	max.	150 °C
Total power dissipation up to $T_{amb} = 25$ °C	$P_{tot}$	max.	625 mW
D.C. current gain $-I_C = 20$ mA; $-V_{CE} = 2$ V	$h_{FE}$	>	30 000
Collector-emitter saturation voltage $-I_C = 100$ mA; $-I_B = 0,1$ mA	$-V_{CEsat}$	max.	1 V
Transition frequency at $f = 100$ MHz $-I_C = 10$ mA; $-V_{CE} = 5$ V	$f_T$	typ.	220 MHz

### MECHANICAL DATA

Dimensions in mm

Fig. 1 TO-92.

#### Pinning

- 1 = emitter
- 2 = base
- 3 = collector

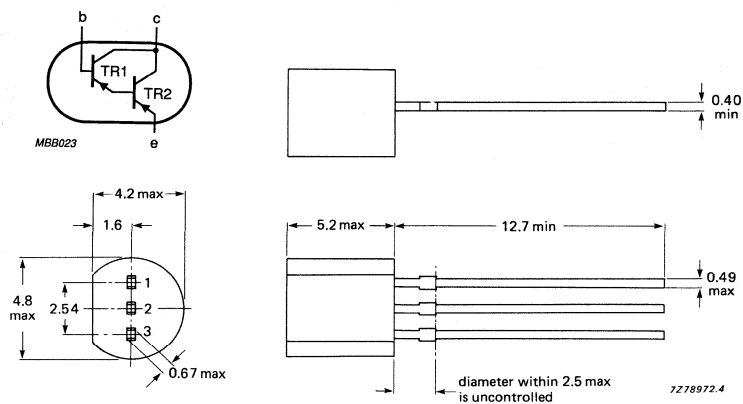

**RATINGS**

Limiting values in accordance with the Absolute Maximum System (IEC 134)

Collector-emitter voltage (open base)	$-V_{CEO}$	max.	30 V
Collector-base voltage (open emitter)	$-V_{CBO}$	max.	40 V
Emitter-base voltage (open collector)	$-V_{EBO}$	max.	10 V
Collector current	$-I_C$	max.	400 mA
Total power dissipation up to $T_{amb} = 25\text{ }^{\circ}\text{C}$	$P_{tot}$	max.	625 mW
Junction temperature	$T_j$	max.	150 $^{\circ}\text{C}$
Storage temperature	$T_{stg}$		$-65$ to $+150\text{ }^{\circ}\text{C}$

**THERMAL RESISTANCE**

From junction to ambient in free air	$R_{th\ j-a}$	max.	200 K/W
From junction to case	$R_{th\ j-c}$	max.	90 K/W

**CHARACTERISTICS** $T_j = 25\text{ }^{\circ}\text{C}$  unless otherwise stated

Collector cut-off current $-V_{CB} = 30\text{ V}$	$-I_{CBO}$	max.	100 nA
Collector-emitter breakdown voltage $-I_C = 2\text{ mA}$	$-V_{(BR)CEO}$	min.	30 V
Collector-base breakdown voltage	$-V_{(BR)CBO}$	min.	40 V
Emitter-base breakdown voltage	$-V_{(BR)EBO}$	min.	10 V
D.C. current gain $-I_C = 20\text{ mA}; -V_{CE} = 2\text{ V}$	$h_{FE}$	$>$	30 000
Collector-emitter saturation voltage $-I_C = 100\text{ mA}; -I_B = 0,1\text{ mA}$	$-V_{CEsat}$	max.	1 V
Base-emitter voltage $-I_C = 10\text{ mA}; -V_{CE} = 5\text{ V}$	$-V_{BE}$	max.	1,4 V
Transition frequency at $f = 100\text{ MHz}$ $-I_C = 10\text{ mA}; -V_{CE} = 5\text{ V}$	$f_T$	typ.	220 MHz



## SILICON PLANAR DARLINGTON TRANSISTOR

N-P-N silicon planar darlington transistor in a plastic TO-92 envelope.  
P-N-P complement is BC516.

### QUICK REFERENCE DATA

Collector-emitter voltage (open base)	$V_{CEO}$	max.	30 V
Collector-base voltage (open emitter)	$V_{CBO}$	max.	40 V
Collector current	$I_C$	max.	400 mA
Junction temperature	$T_j$	max.	150 °C
Total power dissipation up to $T_{amb} = 25$ °C	$P_{tot}$	max.	625 mW
D.C. current gain $I_C = 20$ mA; $V_{CE} = 2$ V	$h_{FE}$	>	30 000
Collector-emitter saturation voltage $I_C = 100$ mA; $I_B = 0,1$ mA	$V_{CEsat}$	max.	1 V
Transition frequency at $f = 100$ MHz $I_C = 30$ mA; $V_{CE} = 5$ V	$f_T$	typ.	220 MHz

### MECHANICAL DATA

Dimensions in mm

Fig. 1 TO-92.

#### Pinning

- 1 = emitter
- 2 = base
- 3 = collector

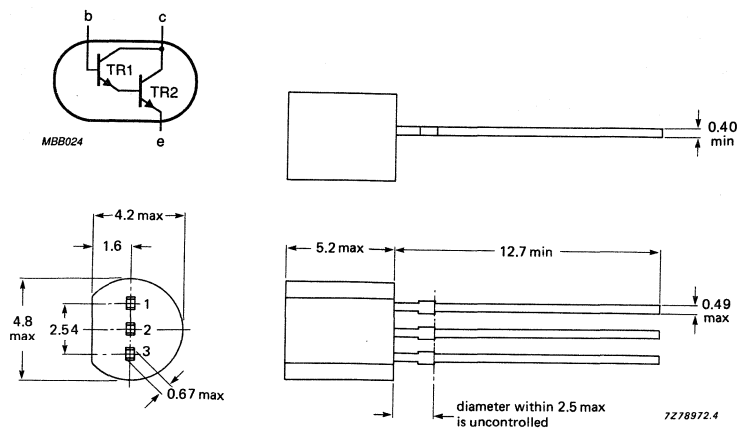

**RATINGS**

Limiting values in accordance with the Absolute Maximum System (IEC 134)

Collector-emitter voltage (open base)	$V_{CEO}$	max.	30 V
Collector-base voltage (open emitter)	$V_{CBO}$	max.	40 V
Emitter-base voltage (open collector)	$V_{EBO}$	max.	10 V
Collector current	$I_C$	max.	400 mA
Total power dissipation up to $T_{amb} = 25\text{ }^\circ\text{C}$	$P_{tot}$	max.	625 mW
Junction temperature	$T_j$	max.	150 $^\circ\text{C}$
Storage temperature	$T_{stg}$		-65 to + 150 $^\circ\text{C}$

**THERMAL RESISTANCE**

From junction to ambient in free air	$R_{th\ j-a}$	max.	200 K/W
From junction to case	$R_{th\ j-c}$	max.	90 K/W

**CHARACTERISTICS** $T_j = 25\text{ }^\circ\text{C}$  unless otherwise stated

Collector cut-off current $V_{CB} = 30\text{ V}$	$I_{CBO}$	max.	100 nA
Collector-emitter breakdown voltage $I_C = 2\text{ mA}$	$V_{(BR)CEO}$	min.	30 V
Collector-base breakdown voltage	$V_{(BR)CBO}$	min.	40 V
Emitter-base breakdown voltage	$V_{(BR)EBO}$	min.	10 V
D.C. current gain $I_C = 20\text{ mA}; V_{CE} = 2\text{ V}$	$h_{FE}$	>	30 000
Collector-emitter saturation voltage $I_C = 100\text{ mA}; I_B = 0,1\text{ mA}$	$V_{CEsat}$	max.	1 V
Base-emitter voltage $I_C = 10\text{ mA}; V_{CE} = 5\text{ V}$	$V_{BE}$	max.	1,4 V
Transition frequency at $f = 100\text{ MHz}$ $I_C = 30\text{ mA}; V_{CE} = 5\text{ V}$	$f_T$	typ.	220 MHz



## SILICON PLANAR EPITAXIAL TRANSISTORS

General purpose n-p-n transistors in a plastic TO-92 envelope, especially suitable for use in driver stages of audio amplifiers.

### QUICK REFERENCE DATA

		BC546	BC547	BC548
Collector-emitter voltage ( $V_{BE} = 0$ )	$V_{CES}$ max.	80	50	30 V
Collector-emitter voltage (open base)	$V_{CEO}$ max.	65	45	30 V
Collector current (peak value)	$I_{CM}$ max.	200	200	200 mA
Total power dissipation up to $T_{amb} = 25\text{ }^{\circ}\text{C}$	$P_{tot}$ max.	500	500	500 mW
Junction temperature	$T_j$ max.	150	150	150 $^{\circ}\text{C}$
D.C. current gain	$h_{FE}$	> 110 < 450	110 800	110 800
Transition frequency	$f_T$ typ.	300	300	300 MHz
Noise figure at $R_S = 2\text{ k}\Omega$ $I_C = 200\text{ }\mu\text{A}$ ; $V_{CE} = 5\text{ V}$ $f = 1\text{ kHz}$ ; $B = 200\text{ Hz}$	F typ.	2	2	2 dB

### MECHANICAL DATA

Dimensions in mm

Fig. 1 TO-92.

#### Pinning

- 1 = emitter
- 2 = base
- 3 = collector

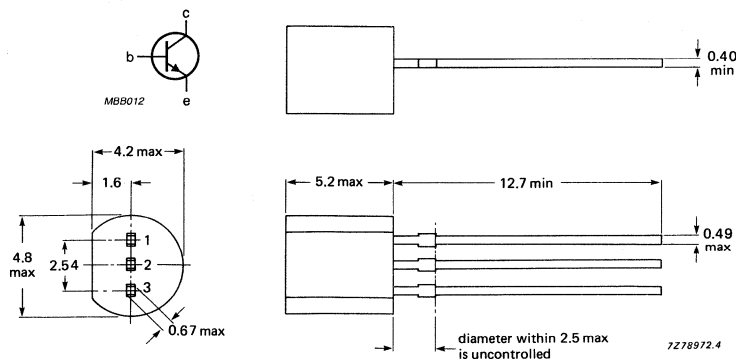

**RATINGS**

Limiting values in accordance with the Absolute Maximum System (IEC 134)

		BC546	BC547	BC548
Collector-base voltage (open emitter)	$V_{CBO}$	max. 80	50	30 V
Collector-emitter voltage ( $V_{BE} = 0$ )	$V_{CES}$	max. 80	50	30 V
Collector-emitter voltage (open base)	$V_{CEO}$	max. 65	45	30 V
Emitter-base voltage (open collector)	$V_{EBO}$	max. 6	6	5 V
Collector current (d.c.)	$I_C$	max.	100	mA
Collector current (peak value)	$I_{CM}$	max.	200	mA
Emitter current (peak value)	$-I_{EM}$	max.	200	mA
Base current (peak value)	$I_{BM}$	max.	200	mA
Total power dissipation up to $T_{amb} = 25\text{ }^\circ\text{C}$	$P_{tot}$	max.	500	mW
Storage temperature	$T_{stg}$		-65 to + 150	$^\circ\text{C}$
Junction temperature	$T_j$	max.	150	$^\circ\text{C}$

**THERMAL RESISTANCE**

From junction to ambient in free air	$R_{th\ j-a}$	=	0,25	K/mW
From junction to case	$R_{th\ j-c}$	=	0,15	K/mW

**CHARACTERISTICS**

$T_j = 25\text{ }^\circ\text{C}$  unless otherwise specified

Collector cut-off current				
$I_E = 0; V_{CB} = 30\text{ V}$	$I_{CBO}$	<	15	nA
$I_E = 0; V_{CB} = 30\text{ V}; T_j = 150\text{ }^\circ\text{C}$	$I_{CBO}$	<	5	$\mu\text{A}$
Base-emitter voltage*				
$I_C = 2\text{ mA}; V_{CE} = 5\text{ V}$	$V_{BE}$	typ.	660	mV
			580 to 700	mV
$I_C = 10\text{ mA}; V_{CE} = 5\text{ V}$	$V_{BE}$	<	770	mV

\*  $V_{BE}$  decreases by about 2 mV/K with increasing temperature.

Saturation voltage\*

$I_C = 10 \text{ mA}; I_B = 0,5 \text{ mA}$

$V_{CEsat}$  typ. 90 mV  
< 250 mV

$V_{BEsat}$  typ. 700 mV

$I_C = 100 \text{ mA}; I_B = 5 \text{ mA}$

$V_{CEsat}$  typ. 200 mV  
< 600 mV

$V_{BEsat}$  typ. 900 mV

Collector capacitance at  $f = 1 \text{ MHz}$

$I_E = I_e = 0; V_{CB} = 10 \text{ V}$

$C_c$  typ. 2,5 pF

Emitter capacitance at  $f = 1 \text{ MHz}$

$I_C = I_c = 0; V_{EB} = 0,5 \text{ V}$

$C_e$  typ. 9 pF

Transition frequency at  $f = 35 \text{ MHz}$

$I_C = 10 \text{ mA}; V_{CE} = 5 \text{ V}$

$f_T$  typ. 300 MHz

Small signal current gain at  $f = 1 \text{ kHz}$

$I_C = 2 \text{ mA}; V_{CE} = 5 \text{ V}$

$h_{fe}$  125 to 900

Noise figure at  $R_S = 2 \text{ k}\Omega$

$I_C = 200 \mu\text{A}; V_{CE} = 5 \text{ V}$

$f = 1 \text{ kHz}; B = 200 \text{ Hz}$

		BC546	BC547	BC548
F	typ.	2	2	2 dB
	<	10	10	10 dB

D.C. current gain

$I_C = 10 \mu\text{A}; V_{CE} = 5 \text{ V}$

		BC546A	BC546B	BC547C
		BC547A	BC547B	BC548C
		BC548A	BC548B	BC548C
$h_{FE}$	typ.	90	150	270
	>	110	200	420
$h_{FE}$	typ.	180	290	520
	<	220	450	800

$I_C = 2 \text{ mA}; V_{CE} = 5 \text{ V}$

\*  $V_{BEsat}$  decreases by about 1,7 mV/K with increasing temperature.

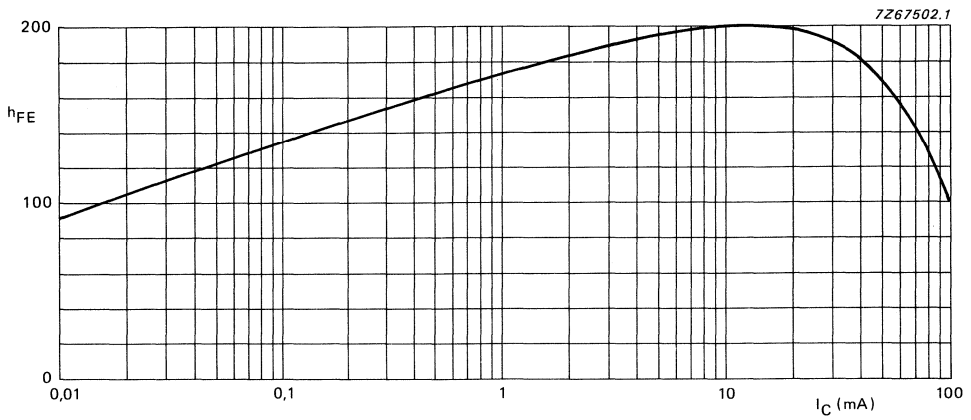

Fig. 2 BC546A, BC547A and BC548A  
 $V_{CE} = 5\text{ V}$ ;  $T_j = 25\text{ }^\circ\text{C}$ ; typical values.

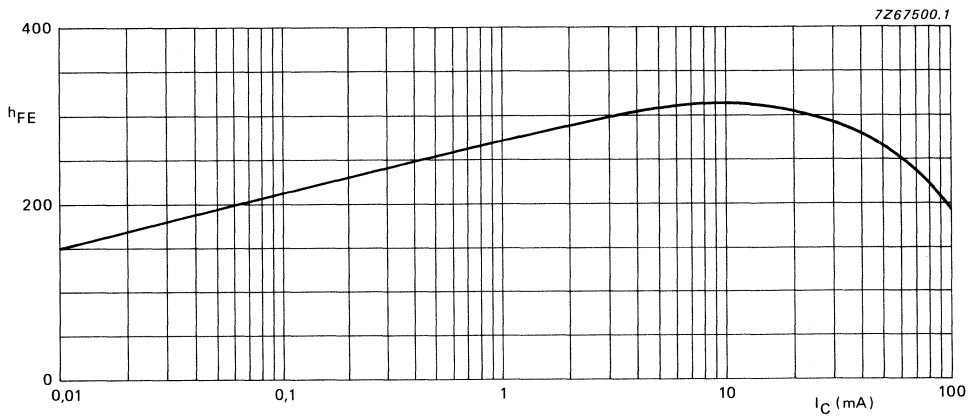

Fig. 3 BC546B, BC547B and BC548B  
 $V_{CE} = 5\text{ V}$ ;  $T_j = 25\text{ }^\circ\text{C}$ ; typical values.



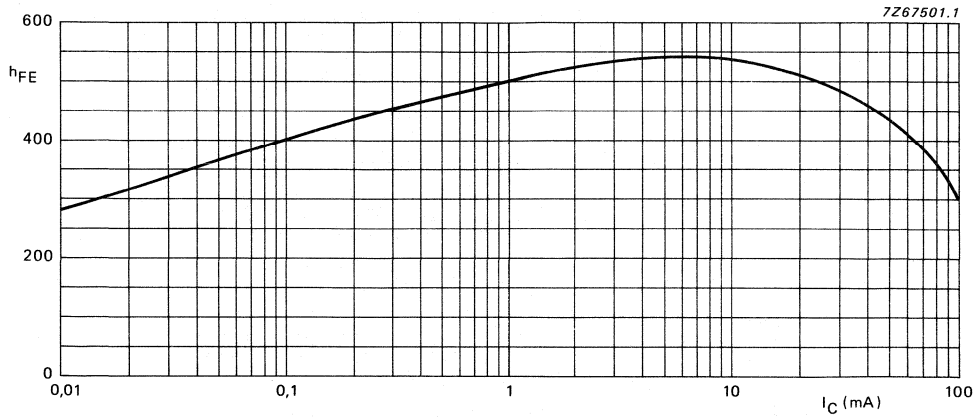

Fig. 4 BC547C and BC548C  
 $V_{CE} = 5 \text{ V}; T_j = 25^\circ\text{C};$  typical values.

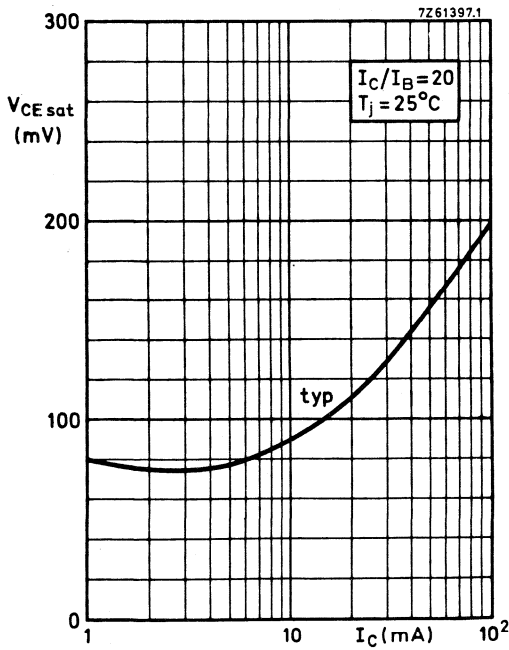

Fig. 5.

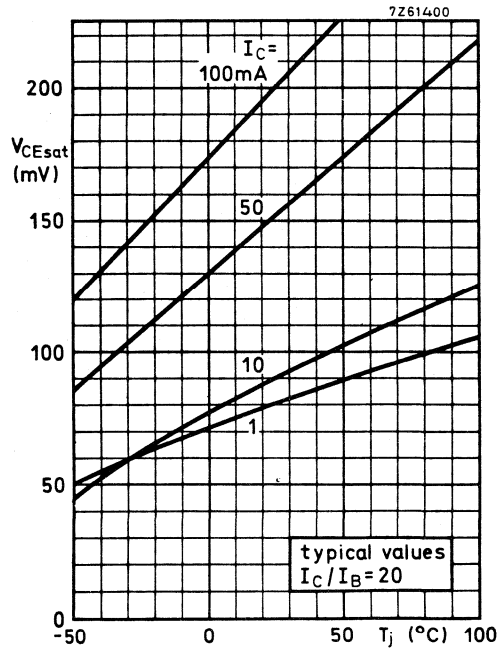

Fig. 6.

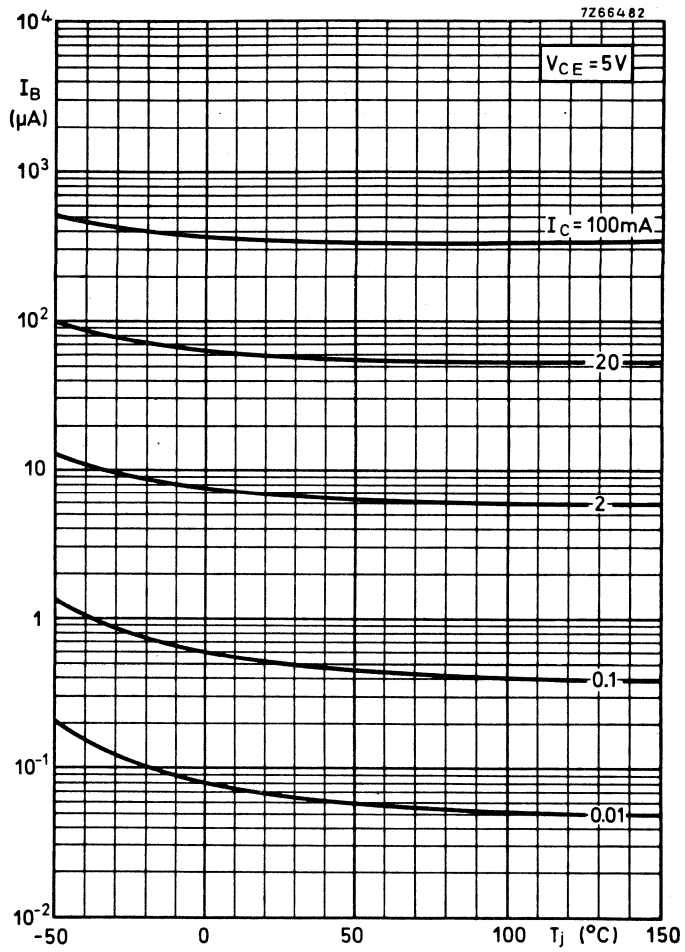

Fig. 7.

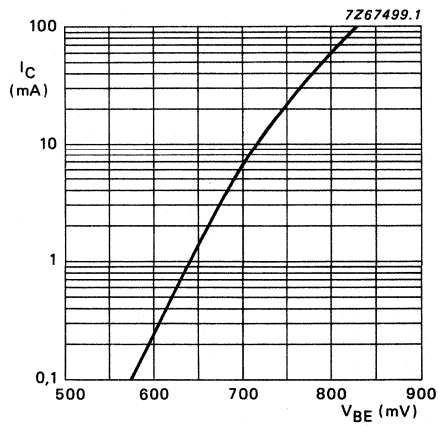

Fig. 8  $V_{CE} = 5\text{ V}$ ;  $T_j = 25\text{ }^\circ\text{C}$ ; typical values.

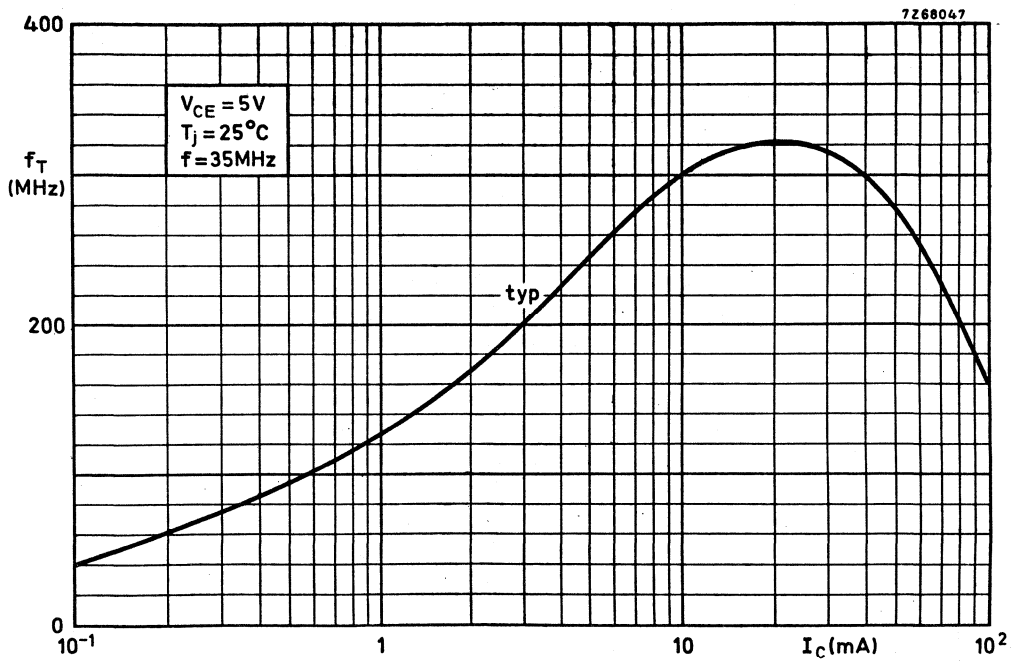

Fig. 9.

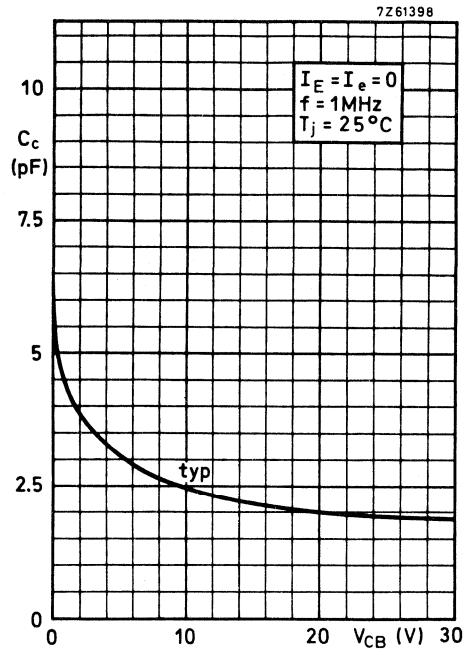

Fig. 10.

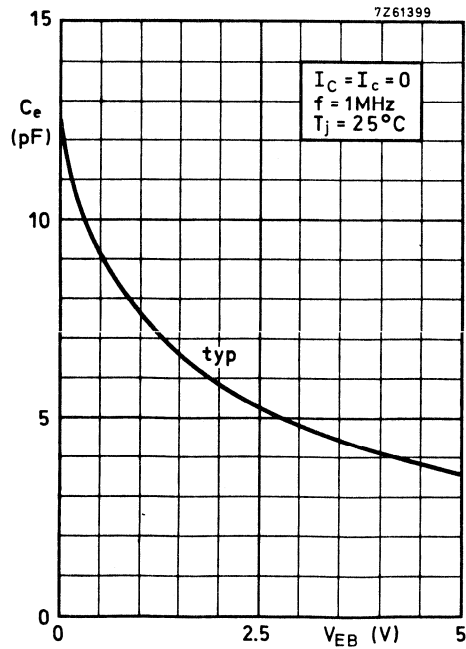

Fig. 11.



## SILICON PLANAR EPITAXIAL TRANSISTORS

N-P-N transistors in plastic TO-92 envelopes, primarily intended for low-noise input stages in tape recorders, hi-fi amplifiers and other audio-frequency equipment.

### QUICK REFERENCE DATA

		BC549	BC550
Collector-emitter voltage ( $V_{BE} = 0$ )	$V_{CES}$ max	30	50 V
Collector-emitter voltage (open base)	$V_{CEO}$ max	30	45 V
Collector current (peak value)	$I_{CM}$ max	200	200 mA
Total power dissipation up to $T_{amb} = 25\text{ }^{\circ}\text{C}$	$P_{tot}$ max	500	500 mW
Junction temperature	$T_j$ max	150	150 $^{\circ}\text{C}$
D.C. current gain	$h_{FE}$	> 200 < 800	200 800
$I_C = 2\text{ mA}; V_{CE} = 5\text{ V}$			
Transition frequency	$f_T$ typ	300	300 MHz
$I_C = 10\text{ mA}; V_{CE} = 5\text{ V}$			
Noise figure at $R_S = 2\text{ k}\Omega$	F	typ 1,4 < 4	1,4 dB 3 dB
$I_C = 200\text{ }\mu\text{A}; V_{CE} = 5\text{ V}$			
$f = 30\text{ Hz to }15\text{ kHz}$			
$f = 1\text{ kHz}; B = 200\text{ Hz}$	F	typ 1,2	1 dB
$f = 10\text{ Hz to }50\text{ Hz}$ (equivalent noise voltage)	$V_n$	< —	0,135 $\mu\text{V}$

### MECHANICAL DATA

Dimensions in mm

Fig. 1 TO-92.

#### Pinning

- 1 = emitter
- 2 = base
- 3 = collector

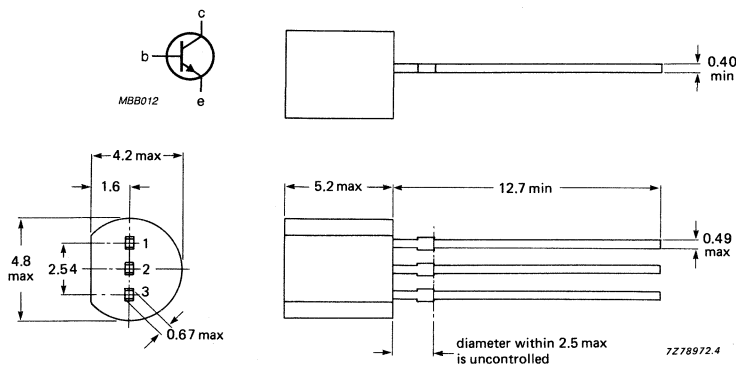

**RATINGS**

Limiting values in accordance with the Absolute Maximum System (IEC 134)

		BC549	BC550
Collector-base voltage (open emitter)	$V_{CBO}$	max. 30	50 V
Collector-emitter voltage ( $V_{BE} = 0$ )	$V_{CES}$	max. 30	50 V
Collector-emitter voltage (open base)	$V_{CEO}$	max. 30	45 V
Emitter-base voltage (open collector)	$V_{EBO}$	max. 5	5 V
Collector current (d.c.)	$I_C$	max.	100 mA
Collector current (peak value)	$I_{CM}$	max.	200 mA
Emitter current (peak value)	$-I_{EM}$	max.	200 mA
Base current (peak value)	$I_{BM}$	max.	200 mA
Total power dissipation up to $T_{amb} = 25\text{ }^\circ\text{C}$	$P_{tot}$	max.	500 mW
Storage temperature	$T_{stg}$		-65 to + 150 $^\circ\text{C}$
Junction temperature	$T_j$	max.	150 $^\circ\text{C}$

**THERMAL RESISTANCE**

From junction to ambient in free air	$R_{thj-a}$	=	0,25 K/mW
From junction to case	$R_{thj-c}$	=	0,15 K/mW

**CHARACTERISTICS**

$T_j = 25\text{ }^\circ\text{C}$  unless otherwise specified

Collector cut-off current $I_E = 0; V_{CB} = 30\text{ V}$	$I_{CBO}$	<	15 nA
$I_E = 0; V_{CB} = 30\text{ V}; T_j = 150\text{ }^\circ\text{C}$	$I_{CBO}$	<	5 $\mu\text{A}$
Base emitter voltage* $I_C = 2\text{ mA}; V_{CE} = 5\text{ V}$	$V_{BE}$	typ.	660 mV 580 to 700 mV
$I_C = 10\text{ mA}; V_{CE} = 5\text{ V}$	$V_{BE}$	<	770 mV
Saturation voltages** $I_C = 10\text{ mA}; I_B = 0,5\text{ mA}$	$V_{CEsat}$	typ.	90 mV < 250 mV
	$V_{BEsat}$	typ.	700 mV
$I_C = 100\text{ mA}; I_B = 5\text{ mA}$	$V_{CEsat}$	typ.	200 mV < 600 mV
	$V_{BEsat}$	typ.	900 mV

\*  $V_{BE}$  decreases by about 2 mV/K with increasing temperature.

\*\*  $V_{BEsat}$  decreases by about 1,7 mV/K with increasing temperature.

Collector capacitance at  $f = 1 \text{ MHz}$

$I_E = I_e = 0; V_{CB} = 10 \text{ V}$

$C_c$  typ. 2,5 pF

Emitter capacitance at  $f = 1 \text{ MHz}$

$I_C = I_c = 0; V_{EB} = 0,5 \text{ V}$

$C_e$  typ. 9 pF

Transition frequency at  $f = 35 \text{ MHz}$

$I_C = 10 \text{ mA}; V_{CE} = 5 \text{ V}$

$f_T$  typ. 300 MHz

Small signal current gain at  $f = 1 \text{ kHz}$

$I_C = 2 \text{ mA}; V_{CE} = 5 \text{ V}$

$h_{fe}$  125 – 900

Noise figure at  $R_S = 2 \text{ k}\Omega$

$I_C = 200 \mu\text{A}; V_{CE} = 5 \text{ V}$

$f = 30 \text{ Hz to } 15 \text{ kHz}$

		BC549	BC550
F	typ.	1,4	1,4 dB
	<	4	3 dB
F	typ.	1,2	1 dB
	<	4	4 dB

$f = 1 \text{ kHz}; B = 200 \text{ Hz}$

Equivalent noise voltage at  $R_S = 2 \text{ k}\Omega$

$I_C = 200 \mu\text{A}; V_{CE} = 5 \text{ V}$

$f = 10 \text{ Hz to } 50 \text{ Hz}; T_{amb} = 25 \text{ }^\circ\text{C}$

$V_n$  max. — 0,135  $\mu\text{V}$

D.C. current gain

$I_C = 10 \mu\text{A}; V_{CE} = 5 \text{ V}$

		BC549B BC550B	BC549C BC550C
$h_{FE}$	typ.	150	270
	>	200	420
$h_{FE}$	typ.	290	520
	<	450	800

$I_C = 2 \text{ mA}; V_{CE} = 5 \text{ V}$

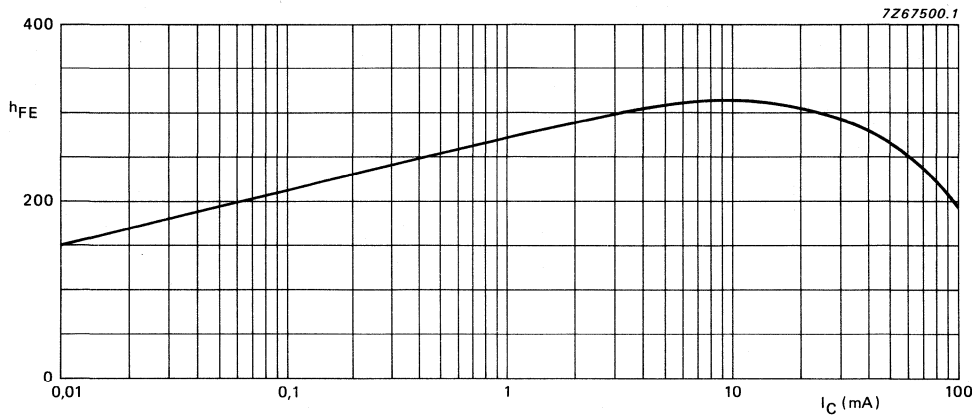

Fig. 2 BC549B and BC550B;  $V_{CE} = 5\text{ V}$ ;  $T_j = 25\text{ }^\circ\text{C}$ ; typical values.

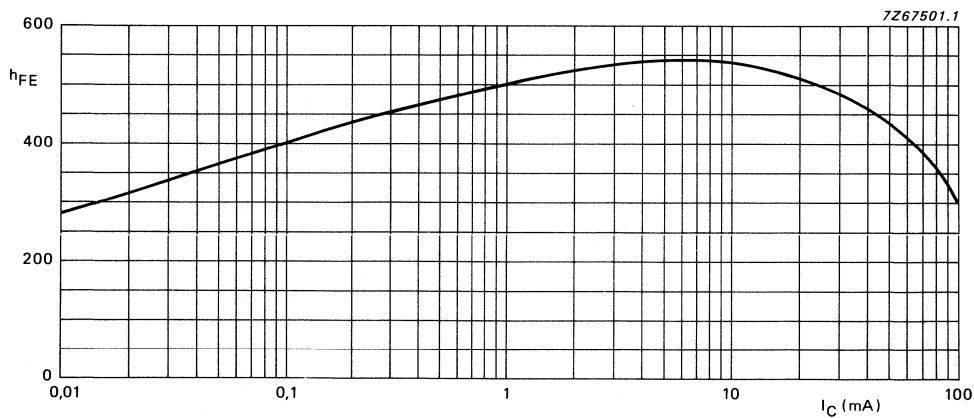

Fig. 3 BC549C and BC550C;  $V_{CE} = 5\text{ V}$ ;  $T_j = 25\text{ }^\circ\text{C}$ ; typical values.



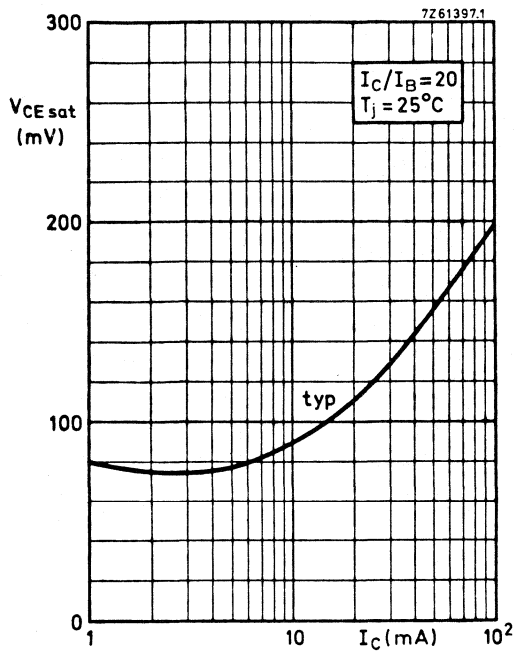

Fig. 4.

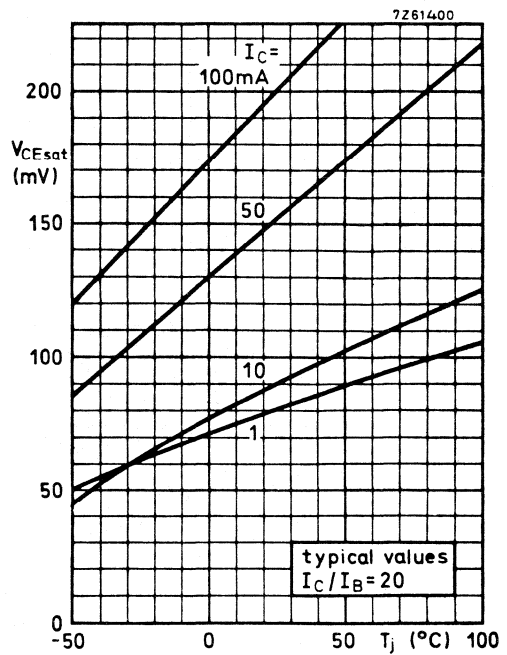

Fig. 5.

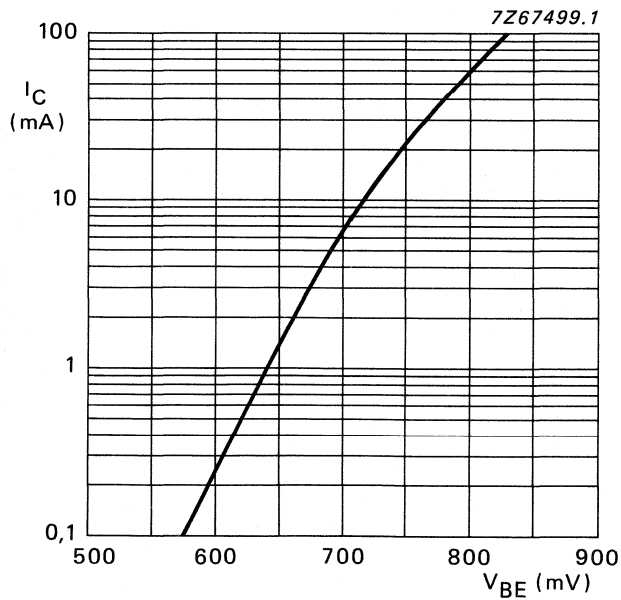

Fig. 6  $V_{CE} = 5\text{ V}$ ;  $T_j = 25^\circ\text{C}$ ; typical values.

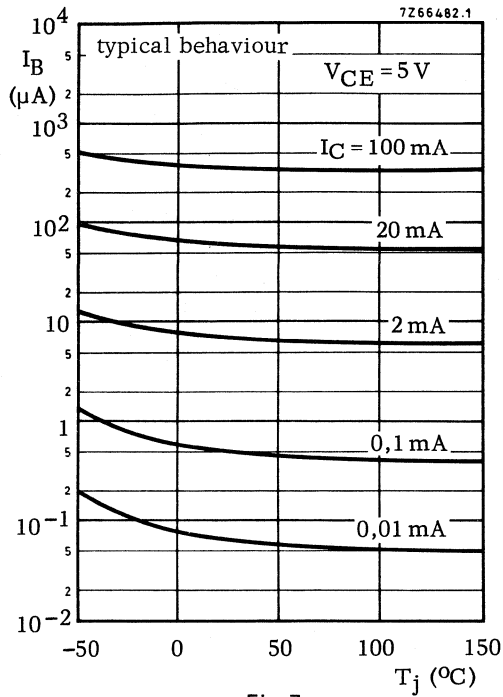

Fig. 7.

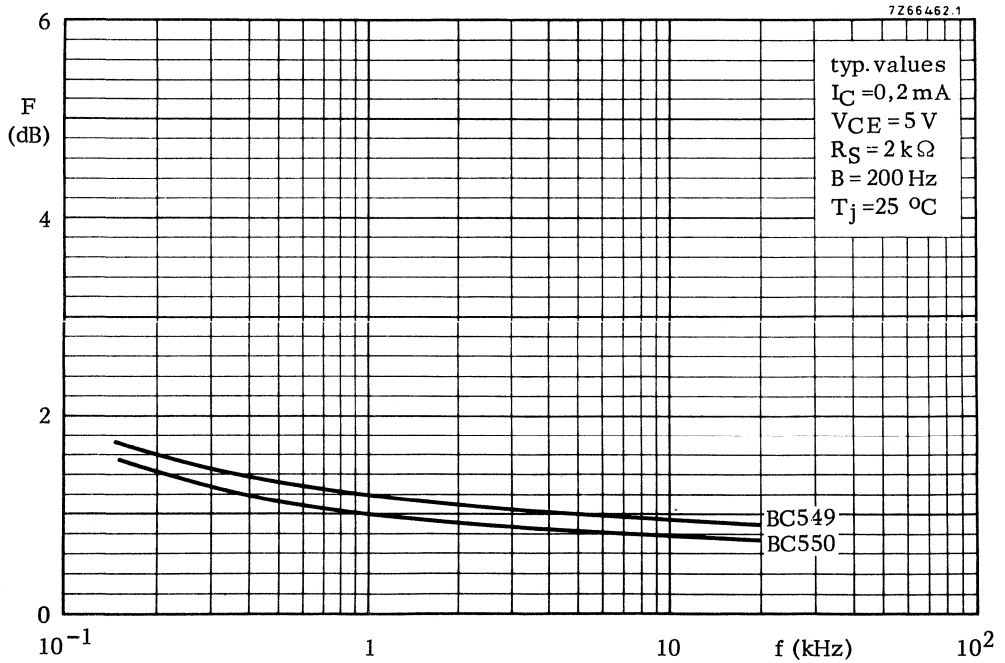

Fig. 8.

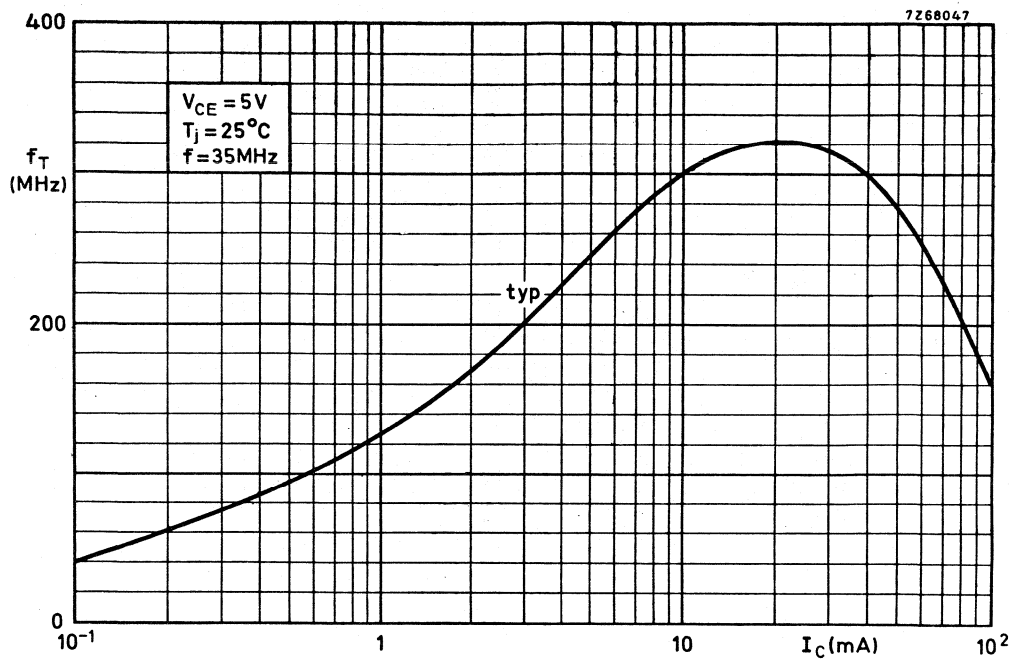

Fig. 9.

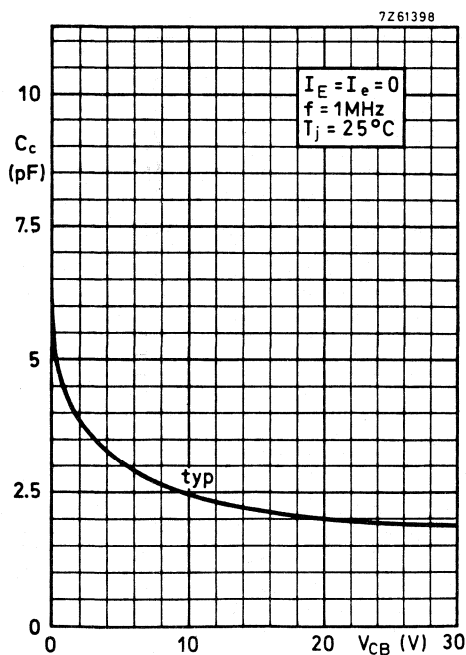

Fig. 10.

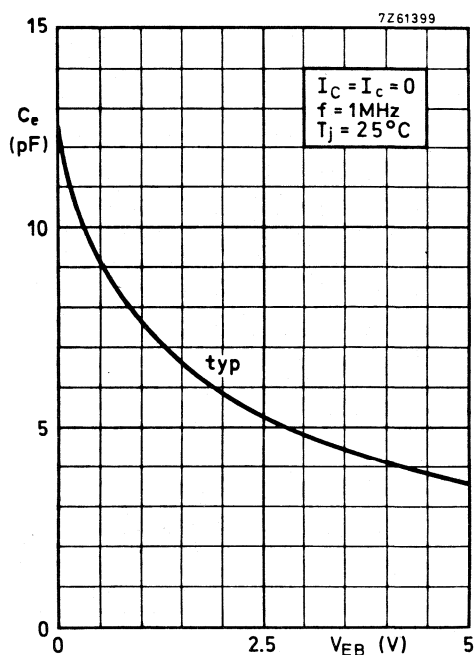

Fig. 11.

Curves of constant noise figure

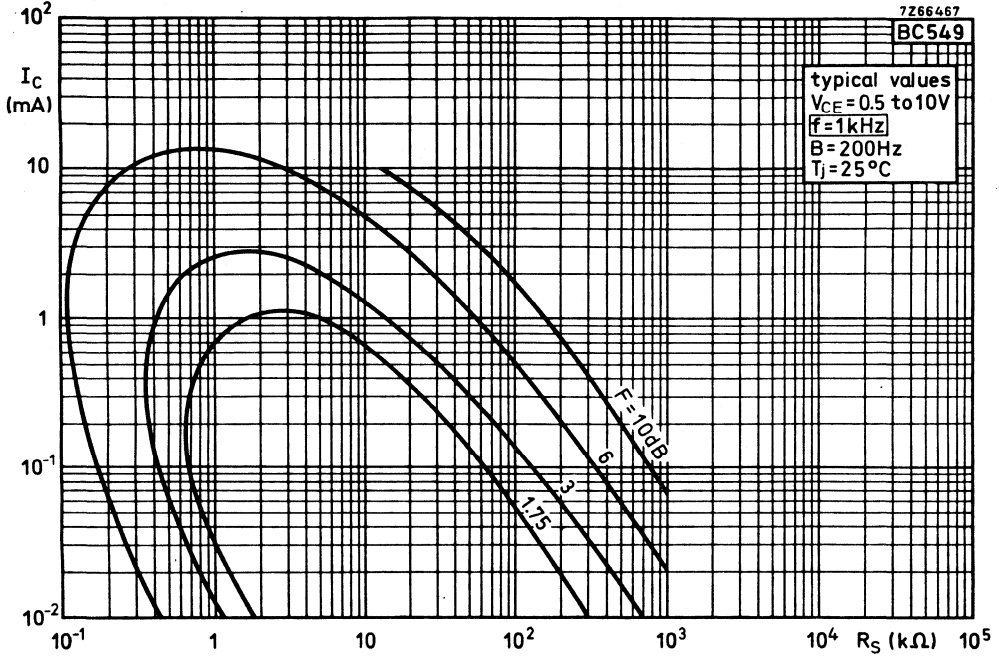

Fig. 12.

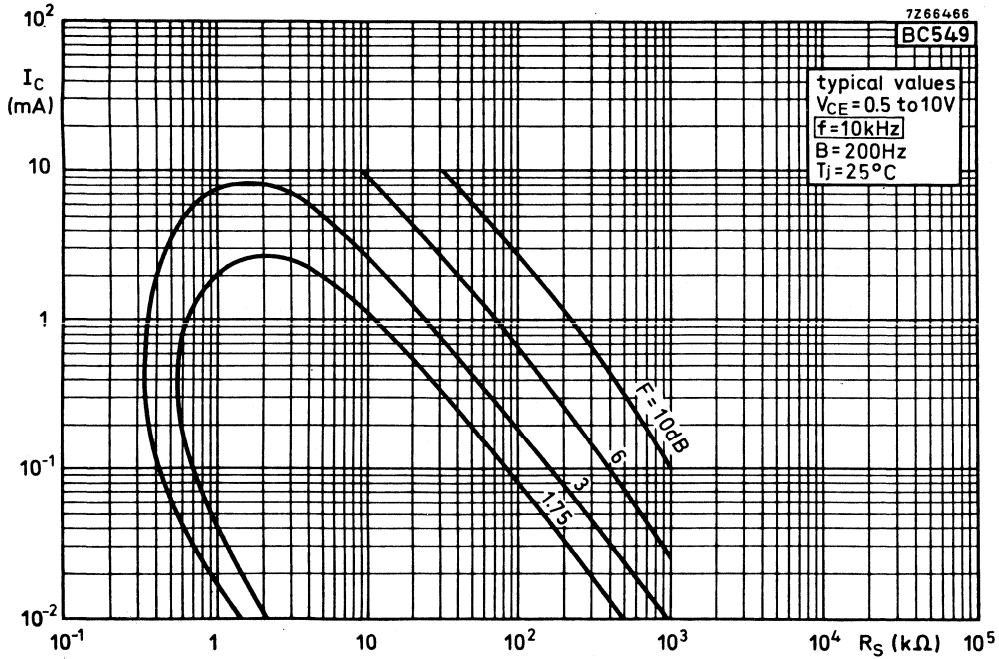

Fig. 13.

Curves of constant noise figure

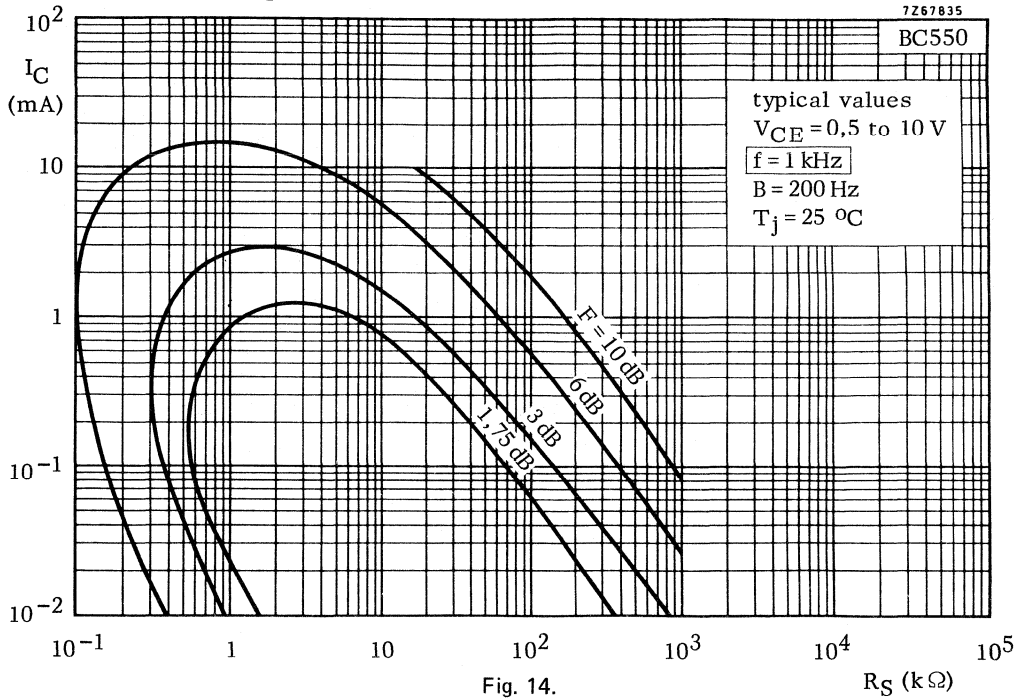

Fig. 14.

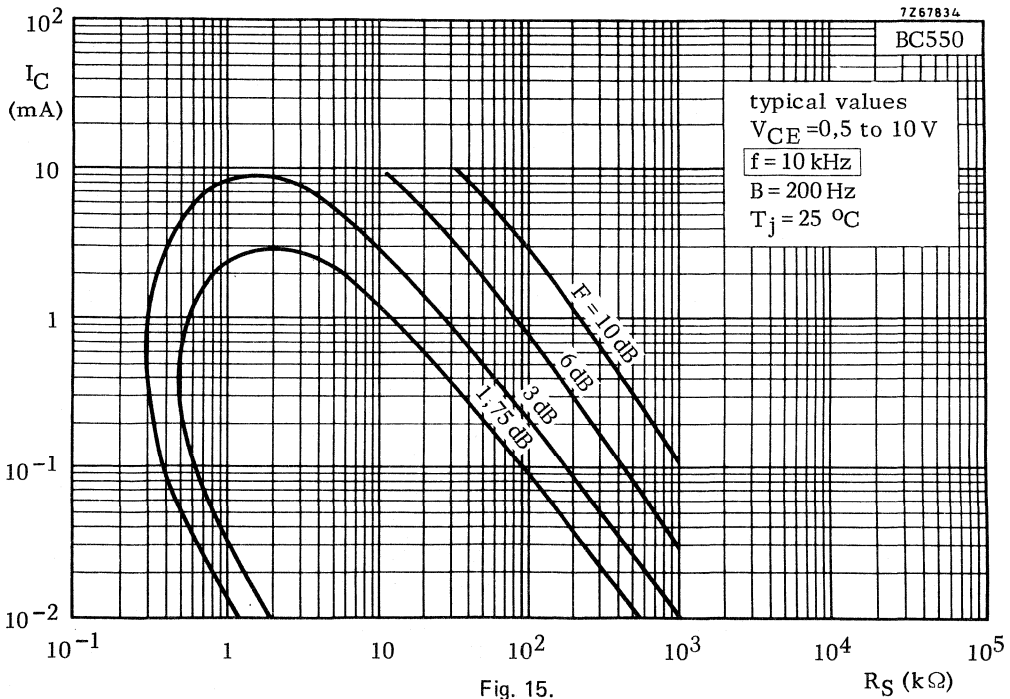

Fig. 15.





## SILICON PLANAR EPITAXIAL TRANSISTORS

General purpose p-n-p transistors in plastic TO-92 envelopes, especially suitable for use in driver stages of audio amplifiers.

### QUICK REFERENCE DATA

		BC556	BC557	BC558	
Collector-emitter voltage (+ $V_{BE} = 0$ V)	$-V_{CES}$ max.	80	50	30	V
Collector-emitter voltage (open base)	$-V_{CEO}$ max.	65	45	30	V
D.C. current gain $-I_C = 2$ mA; $-V_{CE} = 5$ V	$h_{FE} >$	75	75	75	
	$h_{FE} <$	475	800	800	
Collector current (peak value)	$-I_{CM}$ max.		200		mA
Total power dissipation up to $T_{amb} = 25$ °C	$P_{tot}$ max.		500		mW
Junction temperature	$T_j$ max.		150		°C
Transition frequency at $f = 35$ MHz $-I_C = 10$ mA; $-V_{CE} = 5$ V	$f_T$ typ.		200		MHz
	Noise figure at $R_S = 2$ k $\Omega$ $-I_C = 200$ $\mu$ A; $-V_{CE} = 5$ V $f = 1$ kHz; B = 200 Hz	F typ.		2	

### MECHANICAL DATA

Dimensions in mm

Fig. 1 TO-92 variant.

#### Pinning

- 1 = emitter
- 2 = base
- 3 = collector

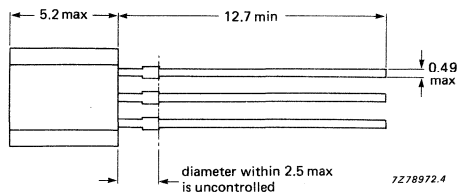
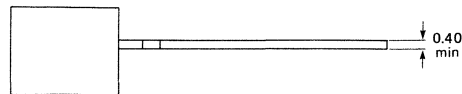
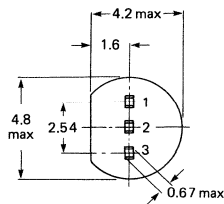
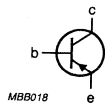

**RATINGS**

Limiting values in accordance with the Absolute Maximum System (IEC 134)

			BC556	BC557	BC558	
Collector-base voltage (open emitter)	$-V_{CBO}$	max.	80	50	30	V
Collector-emitter voltage ( $V_{BE} = 0$ )	$-V_{CES}$	max.	80	50	30	V
Collector-emitter voltage (open base)	$-V_{CEO}$	max.	65	45	30	V
Emitter-base voltage (open collector)	$-V_{EBO}$	max.	5	5	5	V
Collector current (d.c.)	$-I_C$	max.		100		mA
Collector current (peak value)	$-I_{CM}$	max.		200		mA
Emitter current (peak value)	$I_{EM}$	max.		200		mA
Base current (peak value)	$-I_{BM}$	max.		200		mA
Total power dissipation up to $T_{amb} = 25\text{ }^\circ\text{C}$	$P_{tot}$	max.		500		mW
Storage temperature	$T_{stg}$		-65 to + 150			$^\circ\text{C}$
Junction temperature	$T_j$	max.		150		$^\circ\text{C}$

**THERMAL RESISTANCE**

From junction to ambient in free air	$R_{th\ j-a}$	=		250		K/W
From junction to case	$R_{th\ j-c}$	=		150		K/W

**CHARACTERISTICS**

$T_j = 25\text{ }^\circ\text{C}$  unless otherwise specified.

Collector cut-off current

$I_E = 0; -V_{CB} = 30\text{ V}; T_j = 25\text{ }^\circ\text{C}$	$-I_{CBO}$	typ.		1		nA
		<		15		nA
$T_j = 150\text{ }^\circ\text{C}$	$-I_{CBO}$	<		4		$\mu\text{A}$

Base-emitter voltage\*

$-I_C = 2\text{ mA}; -V_{CE} = 5\text{ V}$	$-V_{BE}$	typ.		650		mV
		<		600 to 750		mV
$-I_C = 10\text{ mA}; -V_{CE} = 5\text{ V}$	$-V_{BE}$	<		820		mV

Saturation voltages\*\*

$-I_C = 10\text{ mA}; -I_B = 0,5\text{ mA}$	$-V_{CEsat}$	typ.		60		mV
		<		300		mV
	$-V_{BEsat}$	typ.		750		mV
		<		180		mV
$-I_C = 100\text{ mA}; -I_B = 5\text{ mA}$	$-V_{CEsat}$	typ.		650		mV
		<		930		mV
	$-V_{BEsat}$	typ.				mV

\*  $-V_{BE}$  decreases by about 2 mV/K with increasing temperature.

\*\*  $-V_{BEsat}$  decreases by about 1,7 mV/K with increasing temperature.



Collector capacitance at $f = 1$ MHz $I_E = I_e = 0$ ; $-V_{CB} = 10$ V	$C_C$	typ.	4	pF
Transition frequency at $f = 35$ MHz $-I_C = 10$ mA; $-V_{CE} = 5$ V	$f_T$	typ.	200	MHz
Small-signal current gain at $f = 1$ kHz $-I_C = 2$ mA; $-V_{CE} = 5$ V	$h_{fe}$		75 to 900	
Noise figure at $R_S = 2$ k $\Omega$ $-I_C = 200$ $\mu$ A; $-V_{CE} = 5$ V $f = 1$ kHz; B = 200 Hz	F	typ. <	2 10	dB dB

			<b>BC556A</b>	<b>BC556B</b>	
		<b>BC557</b>	<b>BC557A</b>	<b>BC557B</b>	<b>BC557C</b>
		<b>BC558</b>	<b>BC558A</b>	<b>BC558B</b>	<b>BC558C</b>
D.C. current gain $-I_C = 2$ mA; $-V_{CE} = 5$ V	$h_{FE}$	> <	75 475	75 800	125 250
			220 475	420 800	

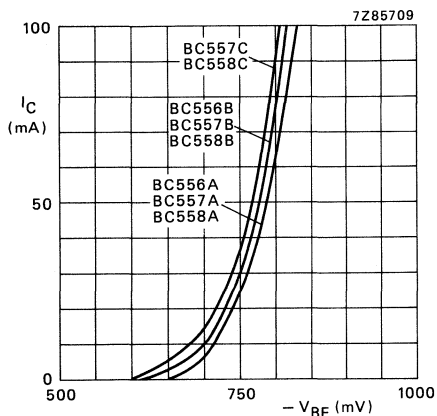

Fig. 2  $-V_{CE} = 5 \text{ V}; T_j = 25 \text{ }^\circ\text{C}.$

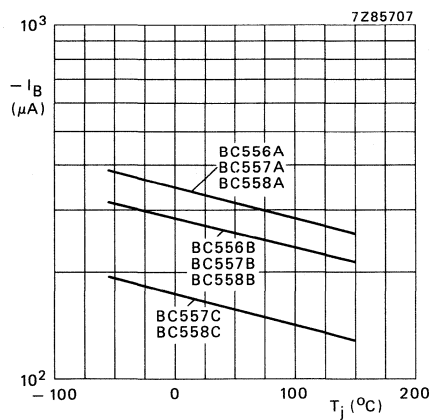

Fig. 3  $-V_{CE} = 5 \text{ V}; I_C = 50 \text{ mA}.$

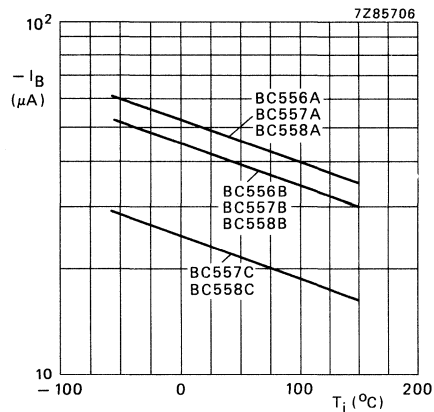

Fig. 4  $-V_{CE} = 5 \text{ V}; I_C = 10 \text{ mA}.$

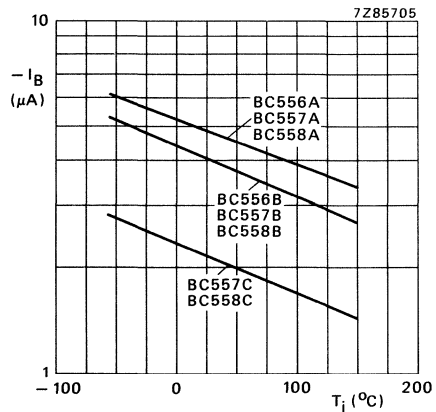

Fig. 5  $-V_{CE} = 5 \text{ V}; I_C = 1 \text{ mA}.$

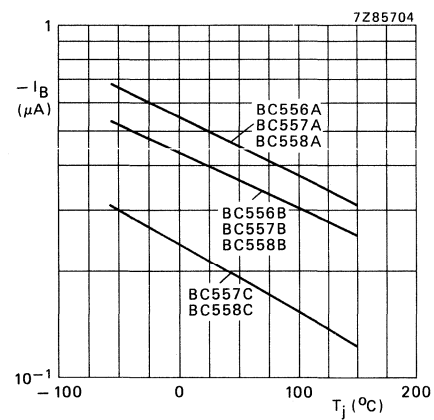

Fig. 6  $-V_{CE} = 5 \text{ V}; I_C = 0,1 \text{ mA}.$

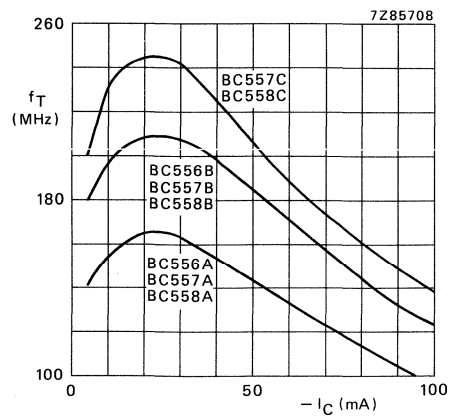

Fig. 7  $-V_{CE} = 5 \text{ V}; T_j = 25 \text{ }^\circ\text{C}; f = 35 \text{ MHz}.$

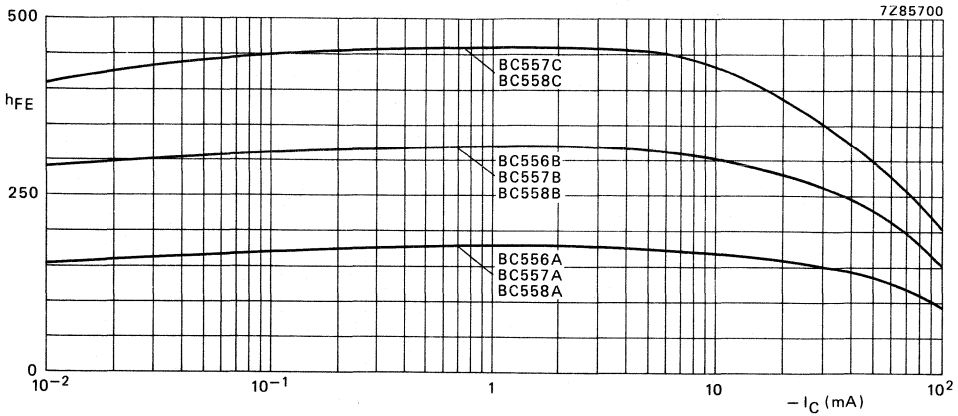

Fig. 8  $-V_{CE} = 5 \text{ V}; T_j = 25 \text{ }^\circ\text{C}.$

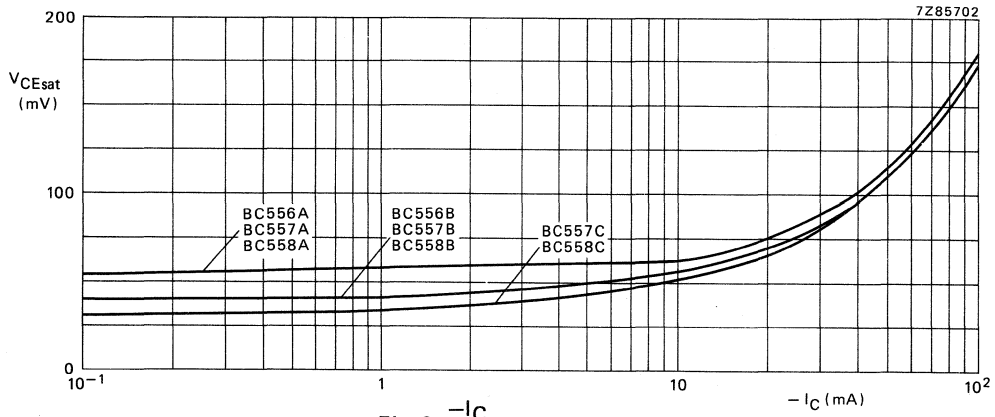

Fig. 9  $\frac{-I_C}{-I_B} = 20; T_j = 25 \text{ }^\circ\text{C}.$

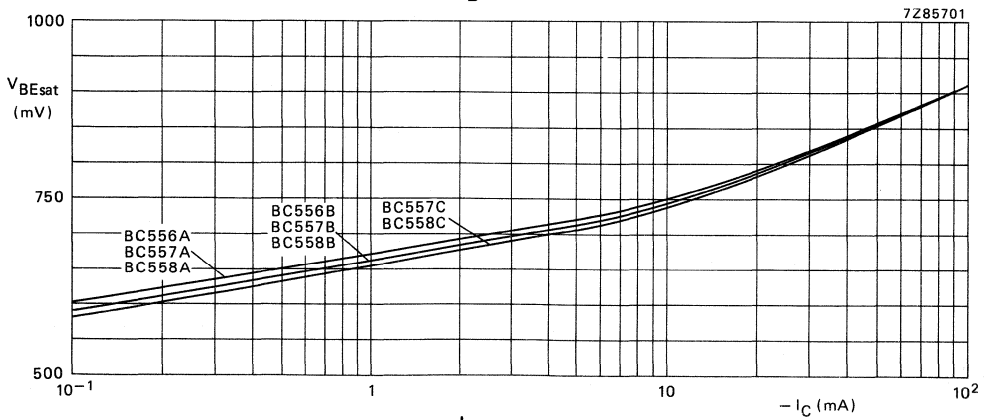

Fig. 10  $\frac{-I_C}{-I_B} = 20; T_j = 25 \text{ }^\circ\text{C}.$

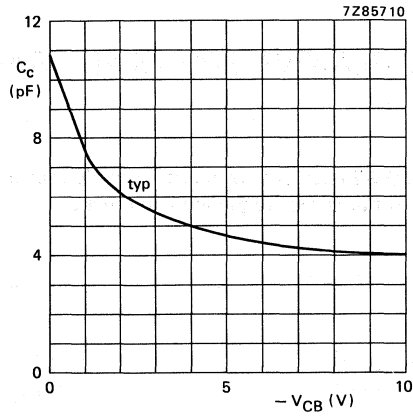

Fig. 11  $f = 1$  MHz;  $T_j = 25$  °C.

## SILICON PLANAR EPITAXIAL TRANSISTORS

P-N-P transistors in a plastic TO-92 envelope, primarily intended for low-noise input stages in tape recorders, hi-fi amplifiers and other audio-frequency equipment.

### QUICK REFERENCE DATA

		BC559	BC560
Collector-emitter voltage (+V <sub>BE</sub> = 0 V)	-V <sub>CES</sub> max.	30	50 V
Collector-emitter voltage (open base)	-V <sub>CEO</sub> max.	30	45 V
Collector current (peak value)	-I <sub>CM</sub> max.	200	200 mA
Total power dissipation up to T <sub>amb</sub> = 25 °C	P <sub>tot</sub> max.	500	500 mW
Junction temperature	T <sub>j</sub> max.	150	150 °C
D.C. current gain	h <sub>FE</sub>	> 125 < 800	125 800
Transition frequency	f <sub>T</sub> typ.	200	200 MHz
Noise figure at R <sub>s</sub> = 2 kΩ	F	typ. 1,2 < 4	1 dB 3 dB
-I <sub>C</sub> = 200 μA; -V <sub>CE</sub> = 5 V f = 30 Hz to 15 kHz	F	< 4	4 dB
f = 1 kHz; B = 200 Hz	V <sub>n</sub>	< -	0,11 μV
f = 10 kHz to 50 Hz (equivalent noise voltage)			

### MECHANICAL DATA

Dimensions in mm

Fig. 1 TO-92.

#### Pinning

- 1 = emitter
- 2 = base
- 3 = collector

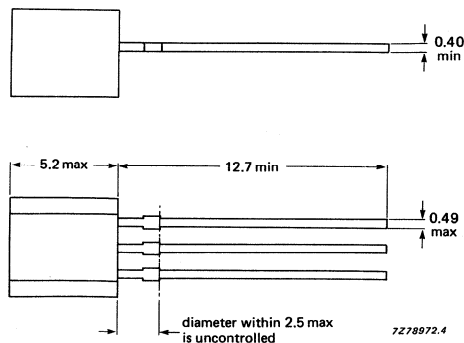
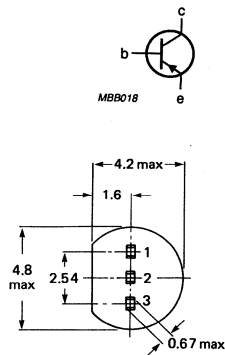

**RATINGS**

Limiting values in accordance with the Absolute Maximum System (IEC 134)

		BC559	BC560
Collector-base voltage (open emitter)	$-V_{CBO}$ max.	30	50 V
Collector-emitter voltage (+ $V_{BE} = 0$ V)	$-V_{CES}$ max.	30	50 V
Collector-emitter voltage (open base)	$-V_{CEO}$ max.	30	45 V
Emitter-base voltage (open collector)	$-V_{EBO}$ max.	5	5 V
Collector current (d.c.)	$-I_C$ max.	100	mA
Collector current (peak value)	$-I_{CM}$ max.	200	mA
Emitter current (peak value)	$I_{EM}$ max.	200	mA
Base current (peak value)	$-I_{BM}$ max.	200	mA
Total power dissipation up to $T_{amb} = 25$ °C	$P_{tot}$ max.	500	mW
Storage temperature	$T_{stg}$	-65 to +150 °C	
Junction temperature	$T_j$ max.	150	°C

**THERMAL RESISTANCE**

From junction to ambient in free air	$R_{th j-a}$ =	250	K/W
From junction to case	$R_{th j-c}$ =	150	K/W

**CHARACTERISTICS**

$T_j = 25$  °C unless otherwise specified

Collector cut-off current

$I_E = 0; -V_{CB} = 30$ V; $T_j = 25$ °C $T_j = 150$ °C	$-I_{CBO}$ typ.	1	nA
	$-I_{CBO} <$	15	nA
	$-I_{CBO} <$	4	µA

Base-emitter voltage\*

$-I_C = 2$ mA; $-V_{CE} = 5$ V $-I_C = 10$ mA; $-V_{CE} = 5$ V	$-V_{BE}$ typ.	650	mV
	$-V_{BE} <$	600 to 750	mV
		820	mV

Saturation voltages\*\*

$-I_C = 10$ mA; $-I_B = 0,5$ mA	$-V_{CEsat}$ typ.	60	mV
	$-V_{CEsat} <$	300	mV
	$-V_{BEsat}$ typ.	750	mV
$-I_C = 100$ mA; $-I_B = 5$ mA	$-V_{CEsat}$ typ.	180	mV
	$-V_{CEsat} <$	650	mV
	$-V_{BEsat}$ typ.	930	mV

\*  $-V_{BE}$  decreases by about 2 mV/K with increasing temperature.

\*\*  $-V_{BEsat}$  decreases by about 1,7 mV/K with increasing temperature.

Collector capacitance at  $f = 1 \text{ MHz}$

$I_E = I_e = 0; -V_{CB} = 10 \text{ V}$

$C_C$  typ. 4 pF

Transition frequency at  $f = 35 \text{ MHz}$

$-I_C = 10 \text{ mA}; -V_{CE} = 5 \text{ V}$

$f_T$  typ. 200 MHz

Small-signal current gain at  $f = 1 \text{ kHz}$

$-I_C = 2 \text{ mA}; -V_{CE} = 5 \text{ V}$

$h_{fe}$  125 to 900

Noise figure at  $R_S = 2 \text{ k}\Omega$

$-I_C = 200 \mu\text{A}; -V_{CE} = 5 \text{ V}$

$f = 30 \text{ Hz to } 15 \text{ kHz}$

		BC559		BC560	
F	typ.	1,2		1	dB
	<	4		3	dB
F	typ.	1		1	dB
	<	4		4	dB

$f = 1 \text{ kHz}; B = 200 \text{ Hz}$

Equivalent noise voltage at  $R_S = 2 \text{ k}\Omega$

$-I_C = 200 \mu\text{A}; -V_{CE} = 5 \text{ V}$

$f = 10 \text{ Hz to } 50 \text{ Hz}; T_{amb} = 25 \text{ }^\circ\text{C}$

$V_n$  < — 0,11  $\mu\text{V}$

D.C. current gain

$-I_C = 2 \text{ mA}; -V_{CE} = 5 \text{ V}$

		BC559 BC560	BC559A BC560A	BC559B BC560B	BC559C BC560C
$h_{FE}$	>	125	125	220	420
	<	800	250	475	800

# BC559 BC560

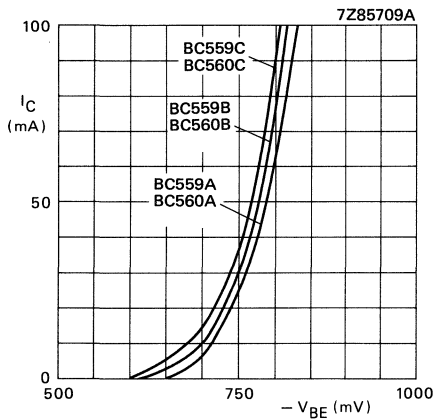

Fig. 2  $-V_{CE} = 5 \text{ V}; T_j = 25 \text{ }^\circ\text{C}$ .

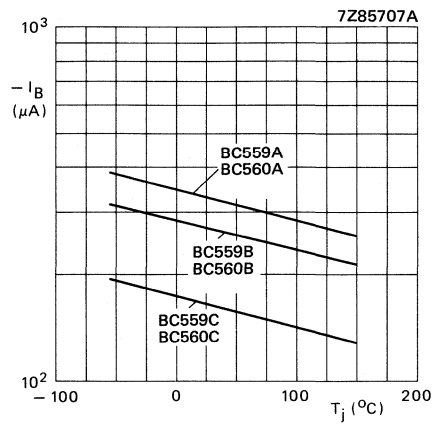

Fig. 3  $-V_{CE} = 5 \text{ V}; I_C = 50 \text{ mA}$ .

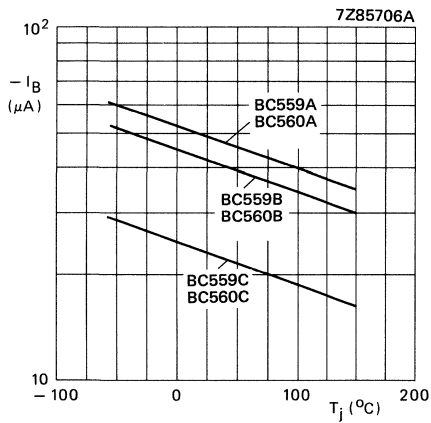

Fig. 4  $-V_{CE} = 5 \text{ V}; I_C = 10 \text{ mA}$ .

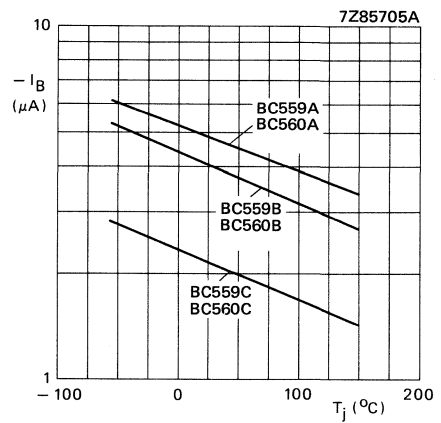

Fig. 5  $-V_{CE} = 5 \text{ V}; I_C = 1 \text{ mA}$ .

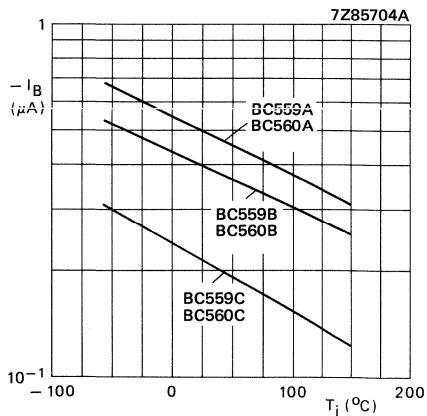

Fig. 6  $-V_{CE} = 5 \text{ V}; I_C = 0,1 \text{ mA}$ .

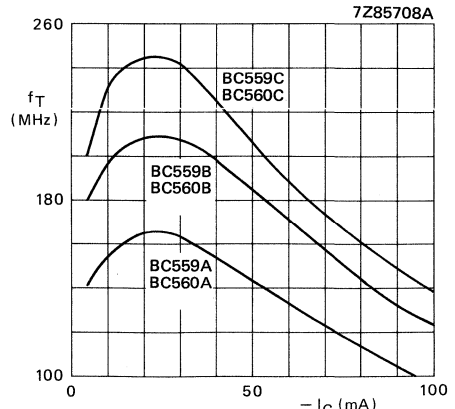

Fig. 7  $-V_{CE} = 5 \text{ V}; T_j = 25 \text{ }^\circ\text{C}; f = 35 \text{ MHz}$ .



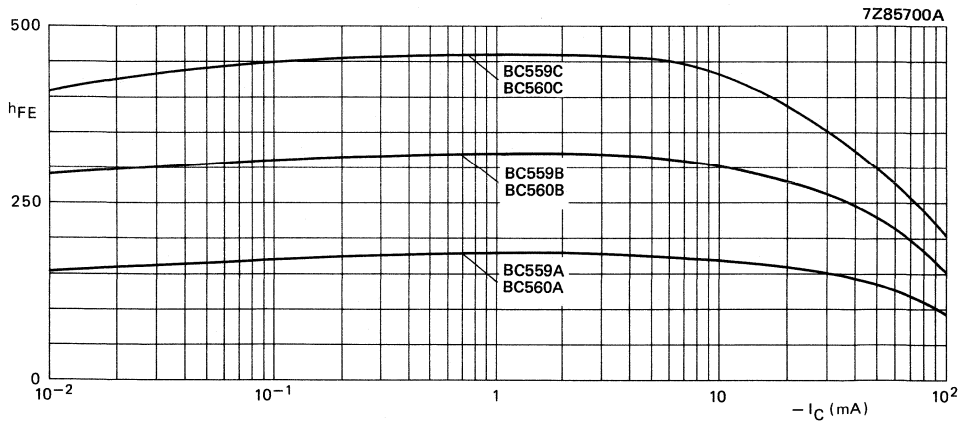

Fig. 8  $-V_{CE} = 5 \text{ V}; T_j = 25 \text{ }^\circ\text{C}.$

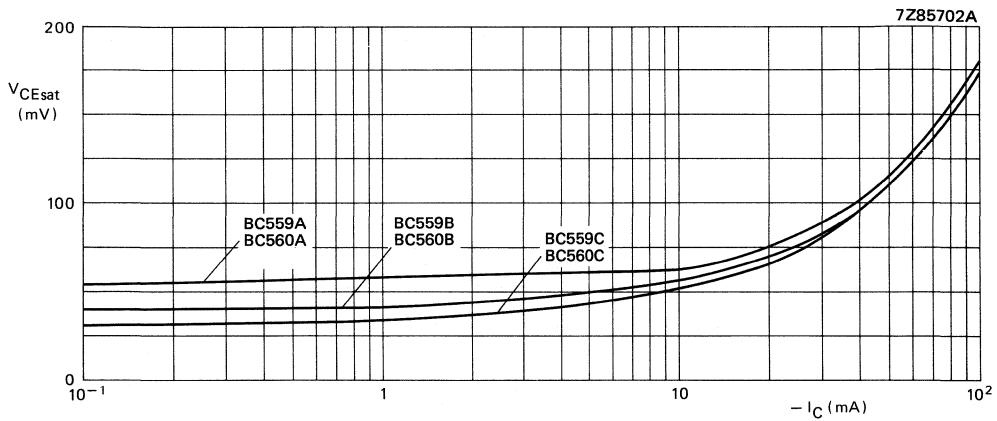

Fig. 9  $\frac{-I_C}{-I_B} = 20; T_j = 25 \text{ }^\circ\text{C}.$

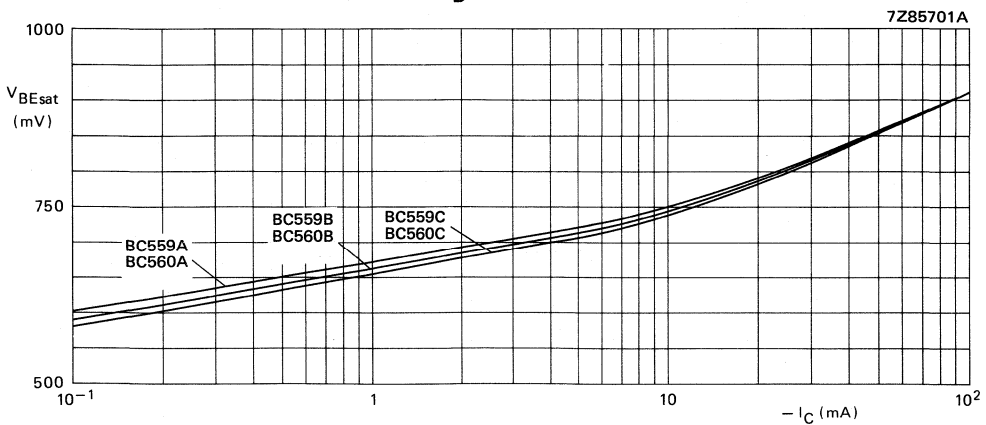

Fig. 10  $\frac{-I_C}{-I_B} = 20; T_j = 25 \text{ }^\circ\text{C}.$

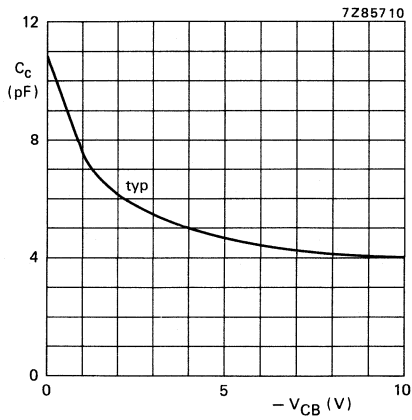

Fig. 11  $f = 1 \text{ MHz}$ ;  $T_j = 25 \text{ }^\circ\text{C}$ .

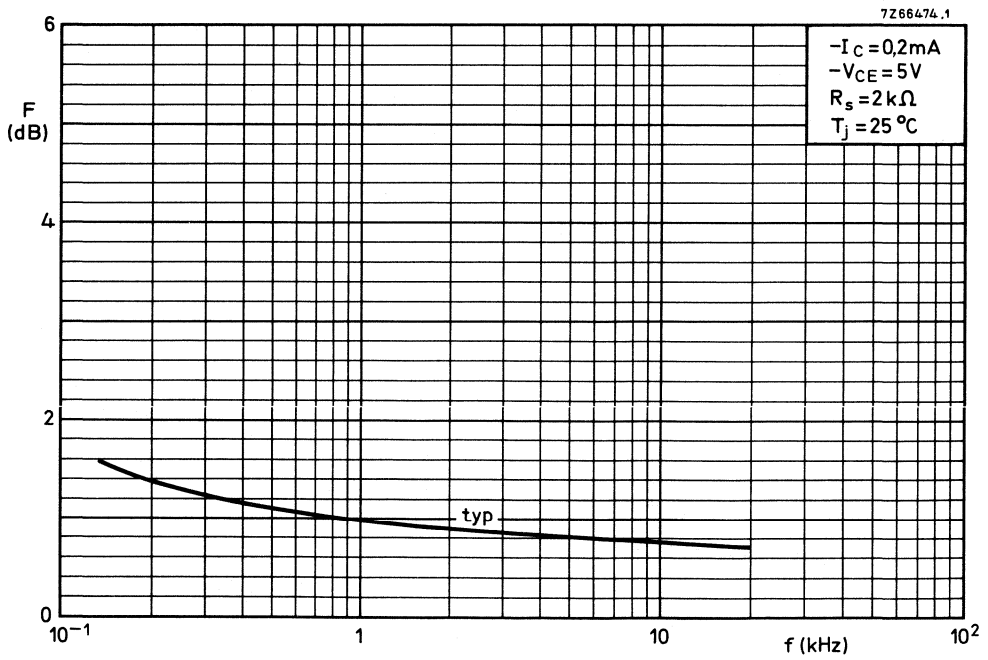

Fig. 12.

curves of constant noise figure

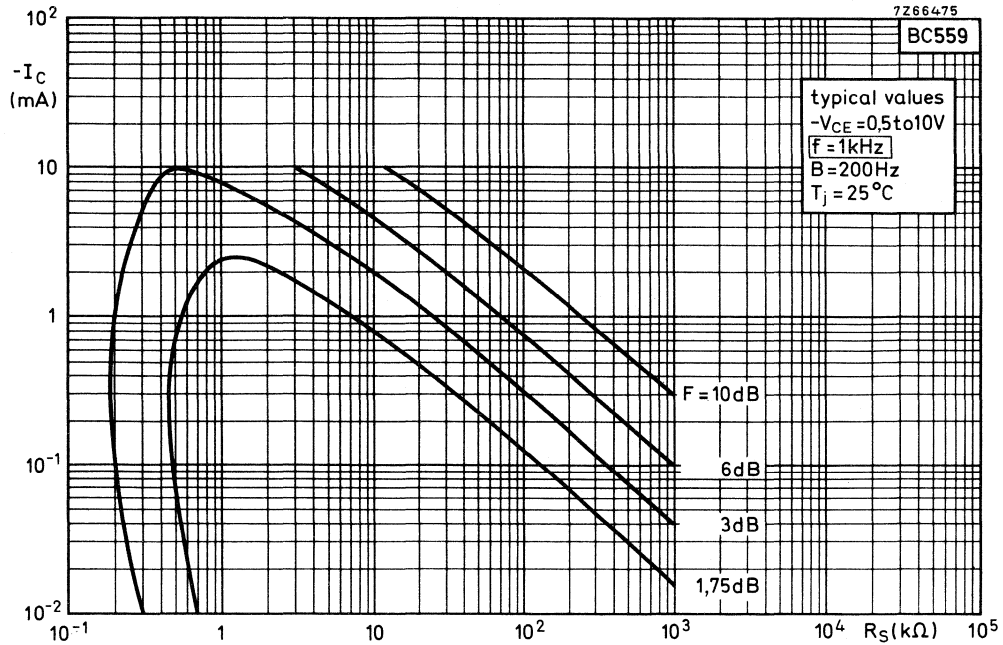

Fig. 13.

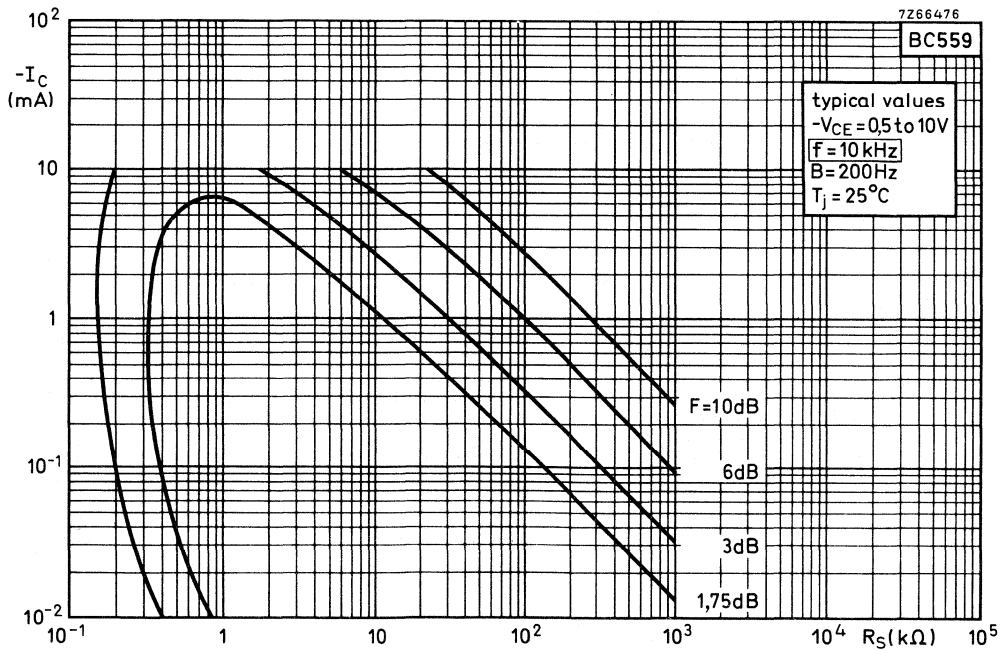

Fig. 14.





## NPN DARLINGTON TRANSISTOR

NPN small-signal Darlington transistors, each in a plastic TO-92 envelope.

They can be used for general purpose low frequency applications and as relay drivers etc.

### QUICK REFERENCE DATA

			BC617	BC618
Collector-base voltage	$V_{CBO}$	max.	50	80 V
Collector-emitter voltage	$V_{CEO}$	max.	40	55 V
DC collector current	$I_C$	max.	1	A
Total power dissipation up to $T_{amb} = 25\text{ }^{\circ}\text{C}$	$P_{tot}$	max.	625	mW
DC current gain $I_C = 1\text{ mA}; V_{CE} = 5\text{ V}$	$h_{FE}$	min.	4000	2000

### MECHANICAL DATA

Dimensions in mm

Fig.1 TO-92.

#### Pinning

- 1 = emitter
- 2 = base
- 3 = collector

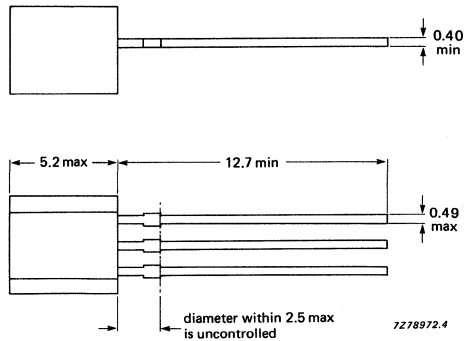
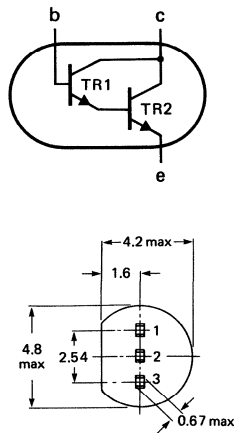

# BC617 BC618

## RATINGS

Limiting values in accordance with the Absolute Maximum System (IEC 134)

			BC617	BC618
Collector-base voltage	$V_{CBO}$	max.	50	80 V
Collector-emitter voltage	$V_{CEO}$	max.	40	55 V
Emitter-base voltage	$V_{EBO}$	max.	12	V
DC collector current	$I_C$	max.	1	A
Total power dissipation up to $T_{amb} = 25\text{ }^{\circ}\text{C}$	$P_{tot}$	max.	625	mW
Storage temperature range	$T_{stg}$		-65 to +150	$^{\circ}\text{C}$
Junction temperature	$T_j$	max.	150	$^{\circ}\text{C}$

## THERMAL RESISTANCE

From junction to ambient in free air	$R_{th\ j-a}$	=	200	K/W
--------------------------------------	---------------	---	-----	-----

## CHARACTERISTICS

$T_j = 25\text{ }^{\circ}\text{C}$  unless otherwise specified

			BC617	BC618
Collector-emitter breakdown voltage $I_C = 10\text{ mA}$	$V_{(BR)CES}$	min.	40	55 V
Collector-base breakdown voltage $I_C = 10\text{ }\mu\text{A}$	$V_{(BR)CBO}$	min.	50	80 V
Emitter-base breakdown voltage $I_E = 100\text{ nA}$	$V_{(BR)EBO}$	min.	12	12 V
Collector cut-off current $V_{CB} = 40\text{ V}; I_E = 0$ $V_{CB} = 60\text{ V}; I_E = 0$	$I_{CBO}$	max.	50	- nA
Emitter cut-off current $V_{EB} = 10\text{ V}; I_C = 0$	$I_{EBO}$	max.	50	50 nA
DC current gain $I_C = 1\text{ mA}; V_{CE} = 5\text{ V}$ $I_C = 10\text{ mA}; V_{CE} = 5\text{ V}$ $I_C = 200\text{ mA}; V_{CE} = 5\text{ V}$	$h_{FE}$	min.	4000	2000
		min.	10000	4000
		min.	10000	10000
		max.	70000	70000
Collector-emitter saturation voltage $I_C = 200\text{ mA}; I_B = 0.2\text{ mA}$	$V_{CEsat}$	max.	1.1	V
Base-emitter saturation voltage $I_C = 200\text{ mA}; I_B = 0.2\text{ mA}$	$V_{BEsat}$	max.	1.6	V
Transition frequency at $T_{amb} = 25\text{ }^{\circ}\text{C}$ $I_C = 500\text{ mA}; V_{CE} = 5\text{ V}; f = 100\text{ MHz}$	$f_T$	min.	155	MHz
Output capacitance $V_{CB} = 30\text{ V}; I_E = 0$	$C_{ob}$	typ.	3.5	pF



## SILICON PLANAR EPITAXIAL TRANSISTORS

N-P-N transistors in a plastic TO-92 envelope, primarily intended for use in driver stages of audio amplifiers. P-N-P complements are BC636, BC638 and BC640.

### QUICK REFERENCE DATA

		BC635	BC637	BC639
Collector-base voltage (open emitter)	$V_{CBO}$ max.	45	60	100 V
Collector-emitter voltage (open base)	$V_{CEO}$ max.	45	60	80 V
Collector-emitter voltage ( $R_{BE} = 1 \text{ k}\Omega$ )	$V_{CER}$ max.	45	60	100 V
Collector-current (peak value)	$I_{CM}$ max.	1,5	1,5	1,5 A
Total power dissipation up to $T_{amb} = 25 \text{ }^\circ\text{C}$	$P_{tot}$ max.	1	1	1 W
Junction temperature	$T_j$ max.	150	150	150 $^\circ\text{C}$
D.C. current gain $I_C = 150 \text{ mA}; V_{CE} = 2 \text{ V}$	$h_{FE}$ >	40	40	40
	$h_{FE}$ <	250	250	250
Transition frequency $I_C = 10 \text{ mA}; V_{CE} = 5 \text{ V}$	$f_T$ typ.	130	130	130 MHz

### MECHANICAL DATA

Dimensions in mm

Fig. 1 TO-92.

#### Pinning

- 1 = base
- 2 = collector
- 3 = emitter

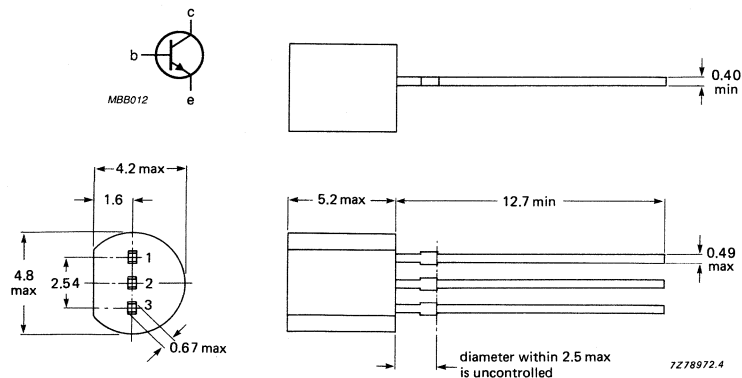

**RATINGS**

Limiting values in accordance with the Absolute Maximum System (IEC 134)

			BC635	BC637	BC639
Collector-base voltage (open emitter)	$V_{CBO}$	max.	45	60	100 V
Collector-emitter voltage (open base)	$V_{CEO}$	max.	45	60	80 V
Collector-emitter voltage ( $R_{BE} = 1 \text{ k}\Omega$ )	$V_{CER}$	max.	45	60	100 V
Collector-emitter voltage ( $R_{BE} = 0$ )	$V_{CES}$	max.	45	60	100 V
Emitter-base voltage (open collector)	$V_{EBO}$	max.	5	5	5 V
Collector current (d.c.)	$I_C$	max.	1		A
Collector current (peak value)	$I_{CM}$	max.	1,5		A
Emitter current (peak value)	$-I_{EM}$	max.	1,5		A
Base current (d.c.)	$I_B$	max.	100		mA
Base current (peak value)	$I_{BM}$	max.	200		mA
Total power dissipation at $T_{amb} = 25 \text{ }^\circ\text{C}$ up to $T_{amb} = 25 \text{ }^\circ\text{C}$	$P_{tot}$	max.	0,8		W
	$P_{tot}$	max.	1		W*
Storage temperature	$T_{stg}$		-65 to + 150		$^\circ\text{C}$
Junction temperature	$T_j$	max.	150		$^\circ\text{C}$

**THERMAL RESISTANCE**

From junction to ambient in free air	$R_{th\ j-a}$	=	156	K/W
From junction to ambient	$R_{th\ j-a}$	=	125	K/W*
From junction to case	$R_{th\ j-c}$	=	60	K/W

\* Transistor mounted on printed circuit board, max. lead length 4 mm, mounting pad for collector lead min. 10 mm x 10 mm.



## CHARACTERISTICS

 $T_j = 25\text{ }^\circ\text{C}$  unless otherwise specified

Collector cut-off current

 $I_E = 0; V_{CB} = 30\text{ V}$  $I_E = 0; V_{CB} = 30\text{ V}; T_j = 150\text{ }^\circ\text{C}$ 

$I_{CBO}$	<	100 nA
$I_{CBO}$	<	10 $\mu\text{A}$

Emitter cut-off current

 $I_C = 0; V_{EB} = 5\text{ V}$ 

$I_{EBO}$	<	10 $\mu\text{A}$
-----------	---	------------------

Base-emitter voltage

 $I_C = 500\text{ mA}; V_{CE} = 2\text{ V}$ 

$V_{BE}$	<	1 V
----------	---	-----

Saturation voltage

 $I_C = 500\text{ mA}; I_B = 50\text{ mA}$ 

$V_{CEsat}$	<	0,5 V
-------------	---	-------

D.C. current gain

 $I_C = 5\text{ mA}; V_{CE} = 2\text{ V}$ 

$h_{FE}$	>	25
----------	---	----

 $I_C = 150\text{ mA}; V_{CE} = 2\text{ V}^*$ 

$h_{FE}$	>	40
$h_{FE}$	<	250

 $I_C = 500\text{ mA}; V_{CE} = 2\text{ V}$ 

$h_{FE}$	>	25
----------	---	----

Transition frequency at  $f = 35\text{ MHz}$  $I_C = 10\text{ mA}; V_{CE} = 5\text{ V}$ 

$f_T$	typ.	130 MHz
-------	------	---------

\* BC635-10

BC637-10

BC639-10

$h_{FE}$	>	63
	<	160

BC635-16

BC637-16

BC639-16

$h_{FE}$	>	100
	<	250

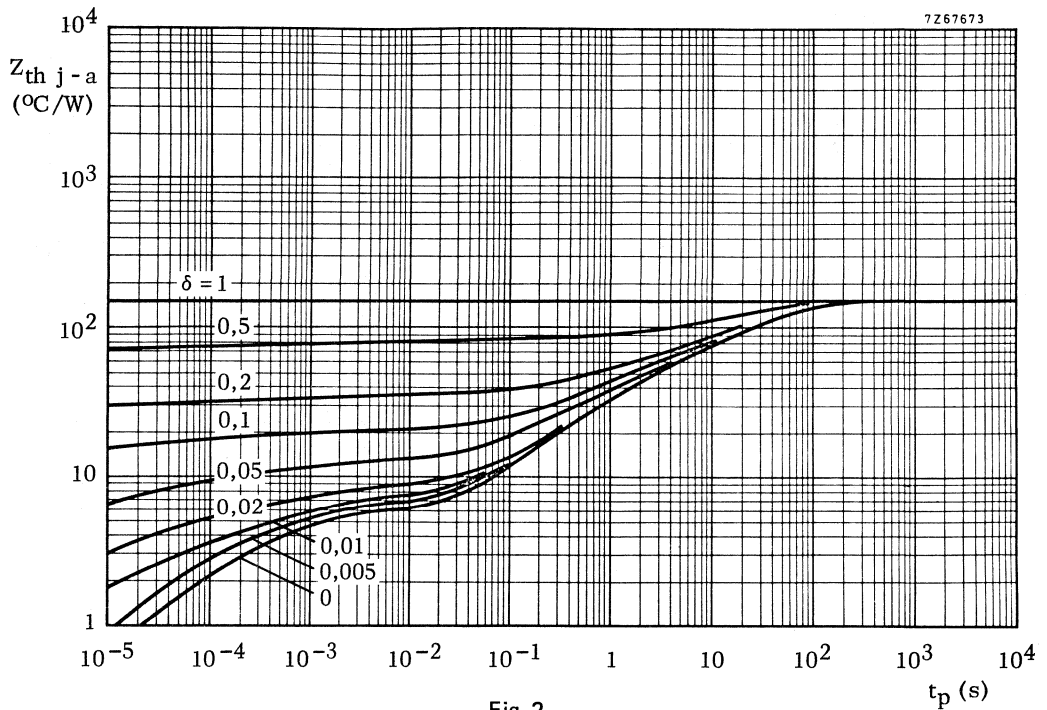

Fig. 2.

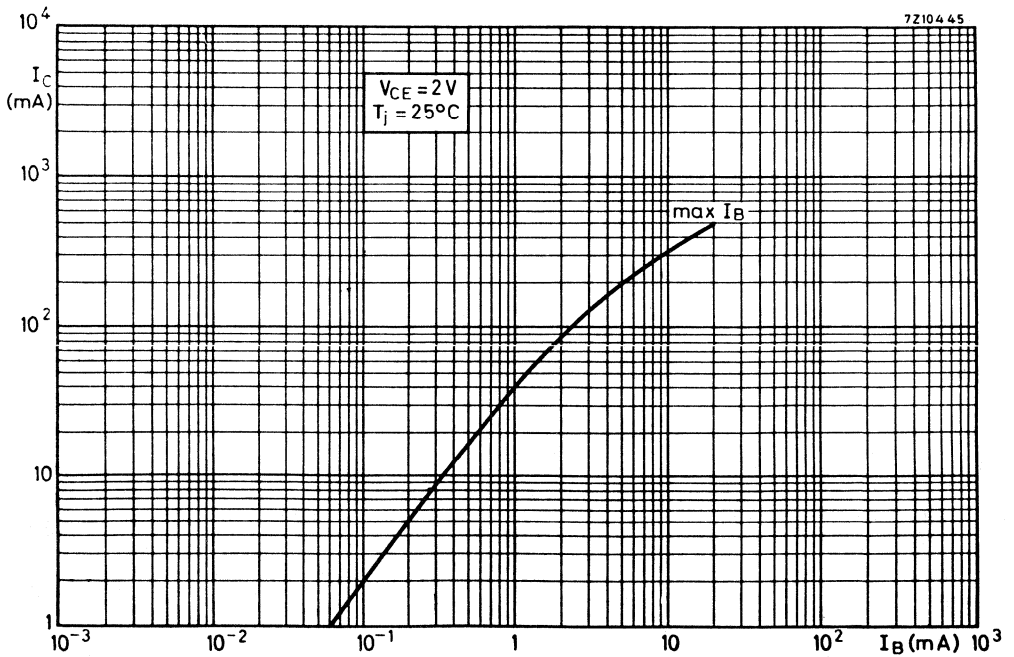

Fig. 3.

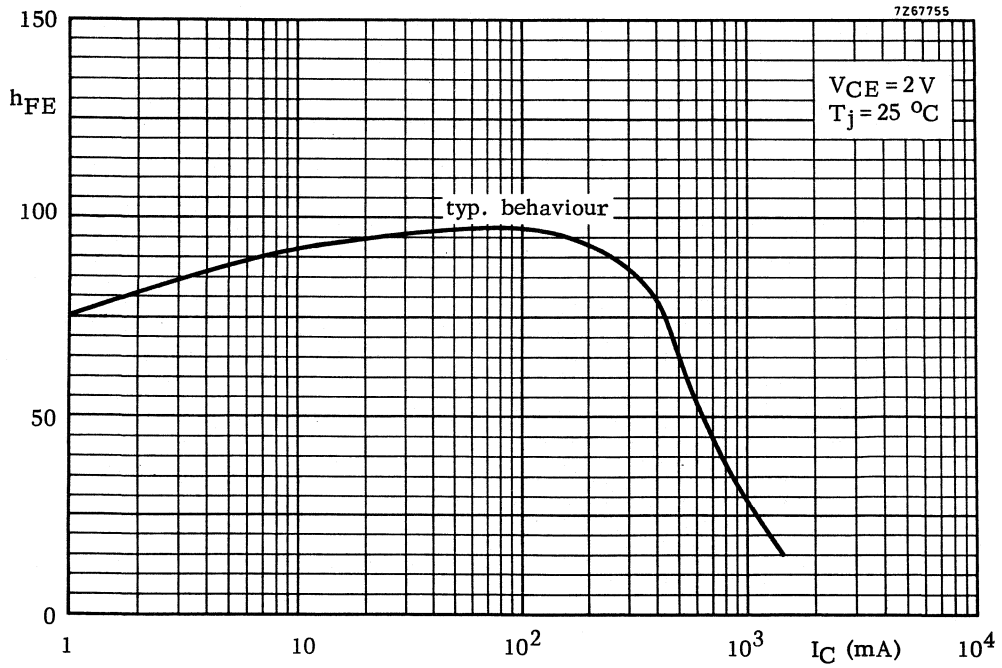

Fig. 4.

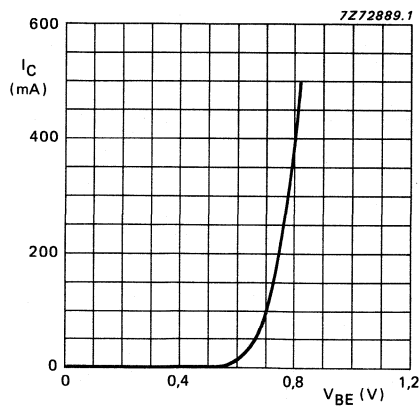

Fig. 5  $V_{CE} = 2\text{ V}$ ;  $T_j = 25\text{ }^\circ\text{C}$ ; typical values.

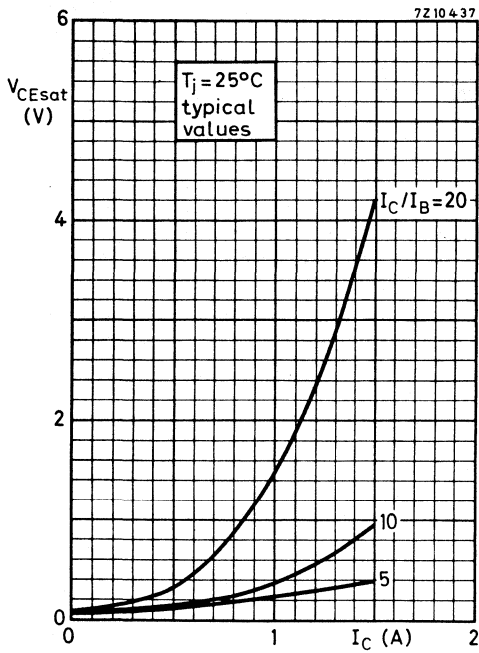

Fig. 6.

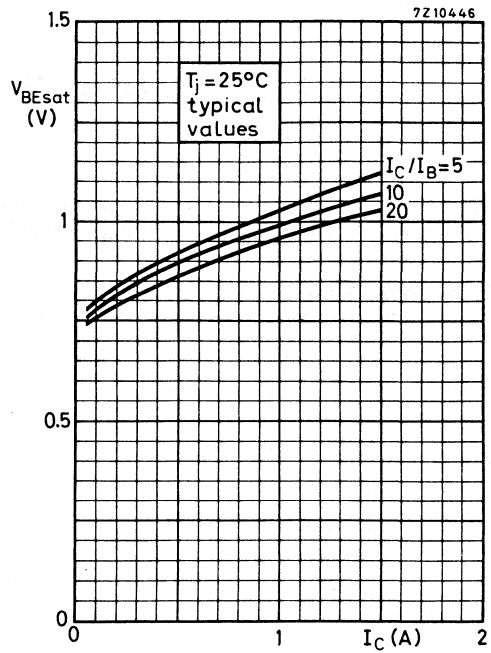

Fig. 7.

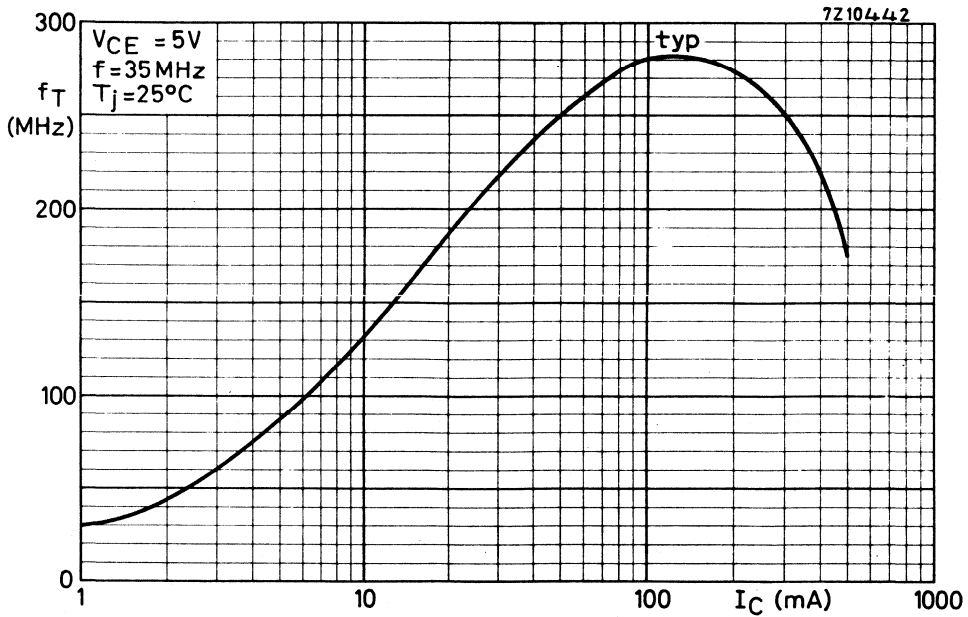

Fig. 8.



## SILICON PLANAR EPITAXIAL TRANSISTORS

P-N-P transistors in a plastic TO-92 envelope, primarily intended for use in driver stages of audio amplifiers. N-P-N complements are BC635, BC637 and BC639.

### QUICK REFERENCE DATA

		BC636	BC638	BC640
Collector-base voltage (open emitter)	$-V_{CBO}$ max.	45	60	100 V
Collector-emitter voltage (open base)	$-V_{CEO}$ max.	45	60	80 V
Collector-emitter voltage ( $R_{BE} = 1\text{ k}\Omega$ )	$-V_{CER}$ max.	45	60	100 V
Collector-current (peak value)	$-I_{CM}$ max.	1,5	1,5	1,5 A
Total power dissipation up to $T_{amb} = 25\text{ }^\circ\text{C}$	$P_{tot}$ max.	1	1	1 W
Junction temperature	$T_j$ max.	150	150	150 $^\circ\text{C}$
D.C. current gain $-I_C = 150\text{ mA}; -V_{CE} = 2\text{ V}$	$h_{FE}$ >	40	40	40
	$h_{FE}$ <	250	250	250
Transition frequency $-I_C = 10\text{ mA}; -V_{CE} = 5\text{ V}$	$f_T$ typ.	50	50	50 MHz

### MECHANICAL DATA

Dimensions in mm

Fig. 1 TO-92.

#### Pinning

- 1 = base
- 2 = collector
- 3 = emitter

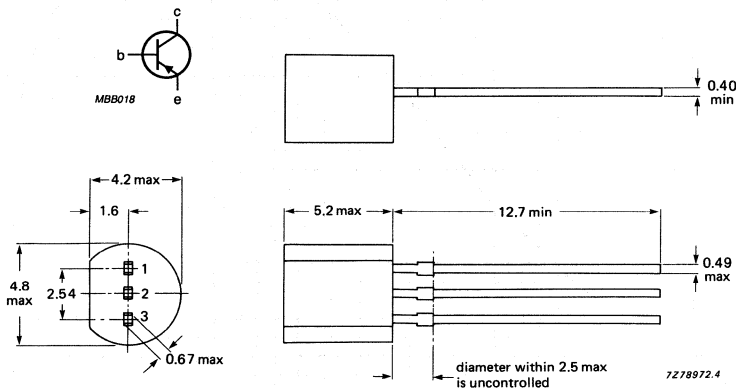

**RATINGS**

Limiting values in accordance with the Absolute Maximum System (IEC 134)

			BC636	BC638	BC640
Collector-base voltage (open emitter)	$-V_{CBO}$	max.	45	60	100 V
Collector-emitter voltage (open base)	$-V_{CEO}$	max.	45	60	80 V
Collector-emitter voltage ( $R_{BE} = 1 \text{ k}\Omega$ )	$-V_{CER}$	max.	45	60	100 V
Collector-emitter voltage ( $-V_{BE} = 0$ )	$-V_{CES}$	max.	45	60	100 V
Emitter-base voltage (open collector)	$-V_{EBO}$	max.	5	5	5 V
Collector current (d.c.)	$-I_C$	max.	1		A
Collector current (peak value)	$-I_{CM}$	max.	1,5		A
Emitter current (peak value)	$I_{EM}$	max.	1,5		A
Base current (d.c.)	$-I_B$	max.	100		mA
Base current (peak value)	$-I_{BM}$	max.	200		mA
Total power dissipation at $T_{amb} = 25 \text{ }^\circ\text{C}$	$P_{tot}$	max.	0,8		W
up to $T_{amb} = 25 \text{ }^\circ\text{C}$	$P_{tot}$	max.	1		W*
Storage temperature	$T_{stg}$		-65 to + 150		$^\circ\text{C}$
Junction temperature	$T_j$	max.	150		$^\circ\text{C}$

**THERMAL RESISTANCE**

From junction to ambient in free air	$R_{thj-a}$	=	156	K/W
From junction to ambient	$R_{thj-a}$	=	125	K/W*
From junction to case	$R_{thj-c}$	=	60	K/W

\* Transistor mounted on printed circuit board, max. lead length 4 mm, mounting pad for collector lead min. 10 mm x 10 mm.

## CHARACTERISTICS

 $T_j = 25\text{ }^\circ\text{C}$  unless otherwise specified

Collector cut-off current

 $I_E = 0; -V_{CB} = 30\text{ V}$  $I_E = 0; -V_{CB} = 30\text{ V}; T_j = 150\text{ }^\circ\text{C}$  $-I_{CBO} < 100\text{ nA}$  $-I_{CBO} < 10\text{ }\mu\text{A}$ 

Emitter cut-off current

 $I_C = 0; -V_{EB} = 5\text{ V}$  $-I_{EBO} < 10\text{ }\mu\text{A}$ 

Base-emitter voltage

 $-I_C = 500\text{ mA}; -V_{CE} = 2\text{ V}$  $-V_{BE} < 1\text{ V}$ 

Saturation voltage

 $-I_C = 500\text{ mA}; -I_B = 50\text{ mA}$  $-V_{CEsat} < 0,5\text{ V}$ 

D.C. current gain

 $-I_C = 5\text{ mA}; -V_{CE} = 2\text{ V}$  $h_{FE} > 25$  $-I_C = 150\text{ mA}; -V_{CE} = 2\text{ V}^*$  $h_{FE} > 40$  $h_{FE} < 250$  $-I_C = 500\text{ mA}; -V_{CE} = 2\text{ V}$  $h_{FE} > 25$ Transition frequency at  $f = 35\text{ MHz}$  $-I_C = 10\text{ mA}; -V_{CE} = 5\text{ V}$  $f_T \text{ typ. } 50\text{ MHz}$ 

\* BC636-10

BC638-10

BC640-10

 $h_{FE} > 63$  $h_{FE} < 160$ 

BC636-16

BC638-16

BC640-16

 $h_{FE} > 100$  $h_{FE} < 250$

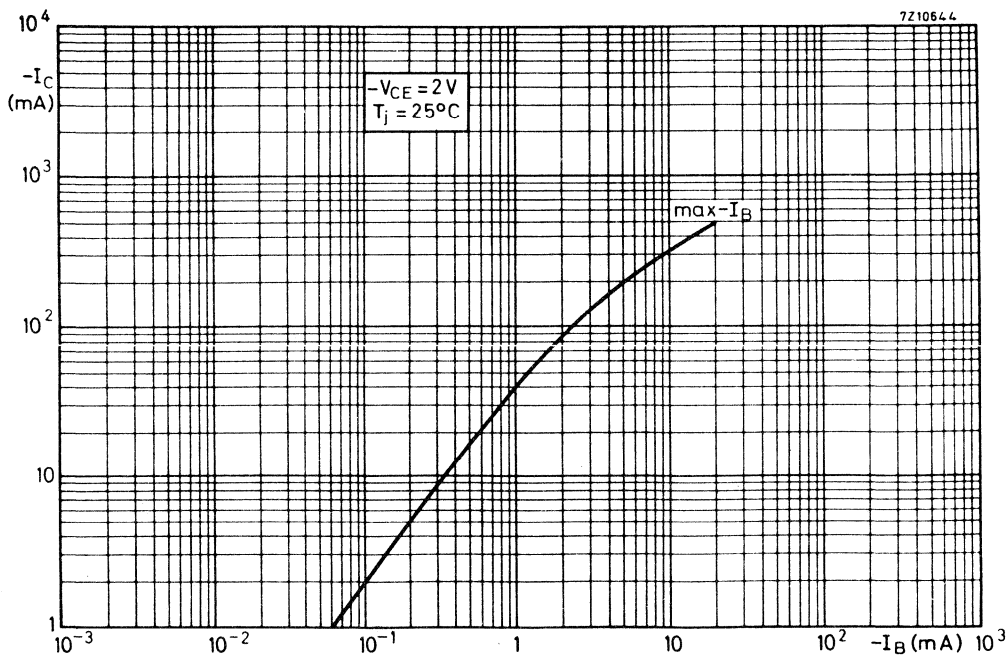
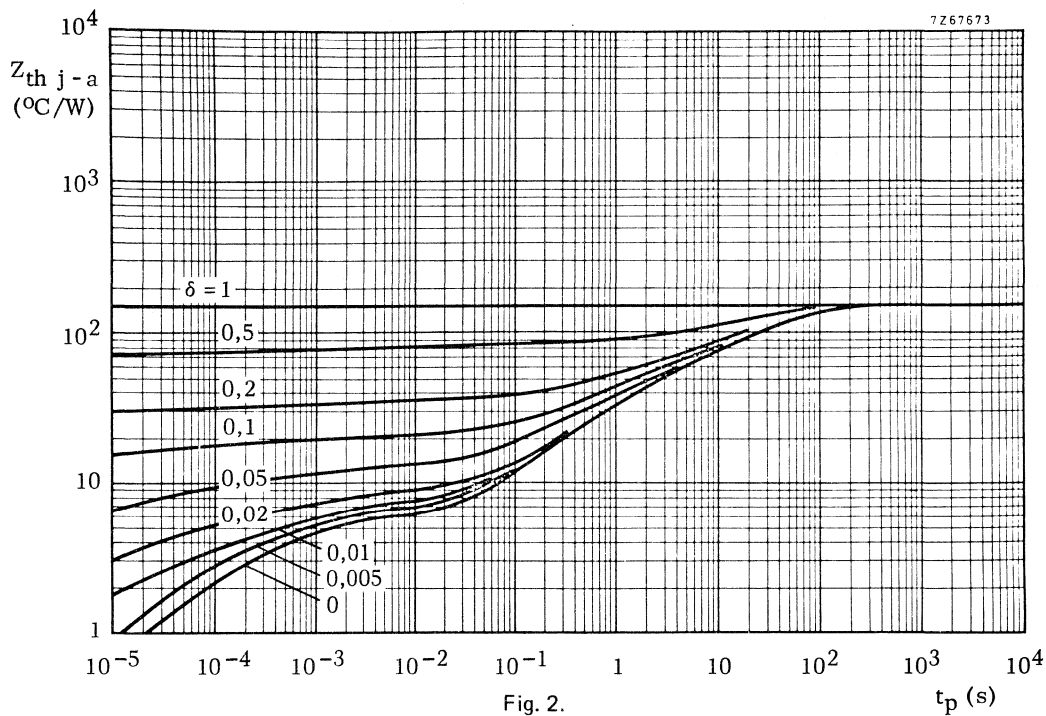



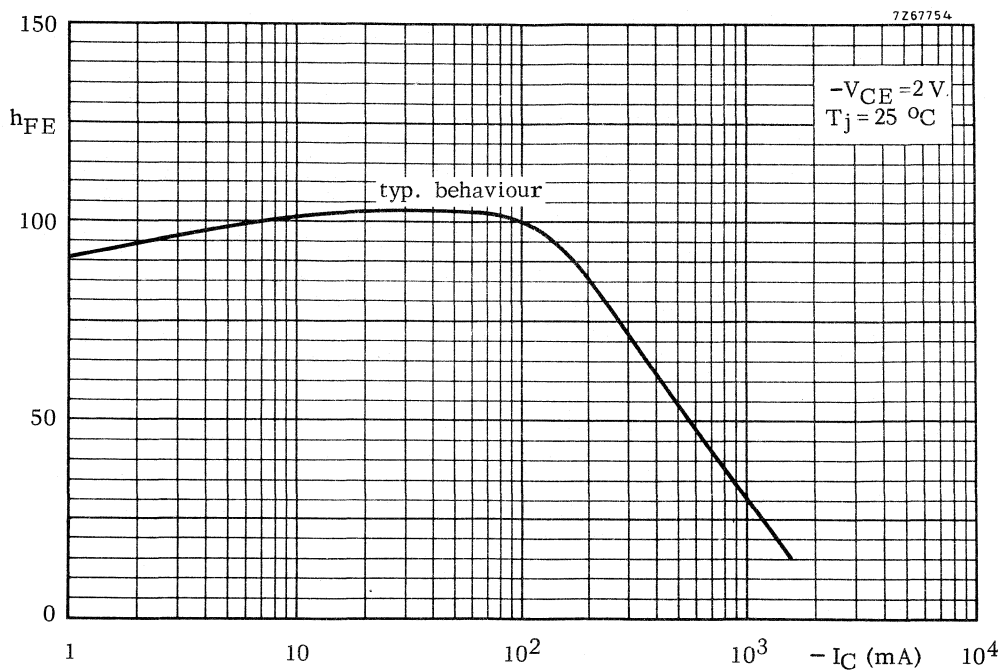

Fig. 4.

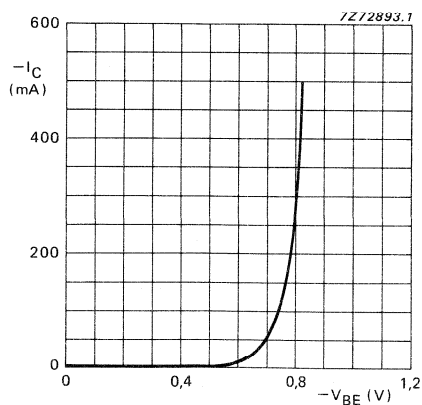

Fig. 5  $-V_{CE} = 2 \text{ V}$ ;  $T_j = 25 \text{ }^\circ\text{C}$ ; typical values.

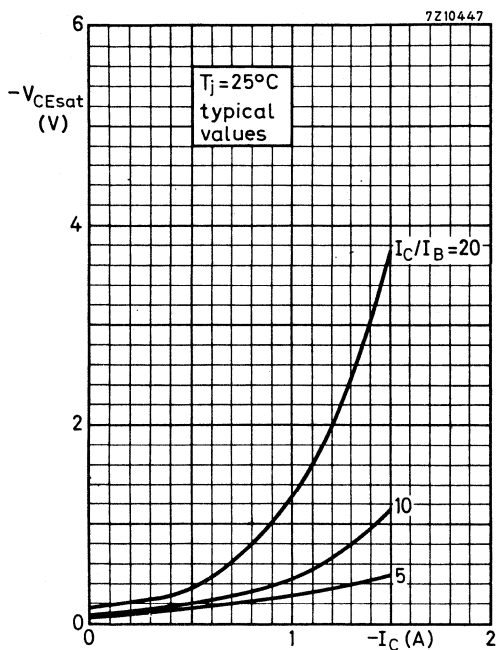

Fig. 6.

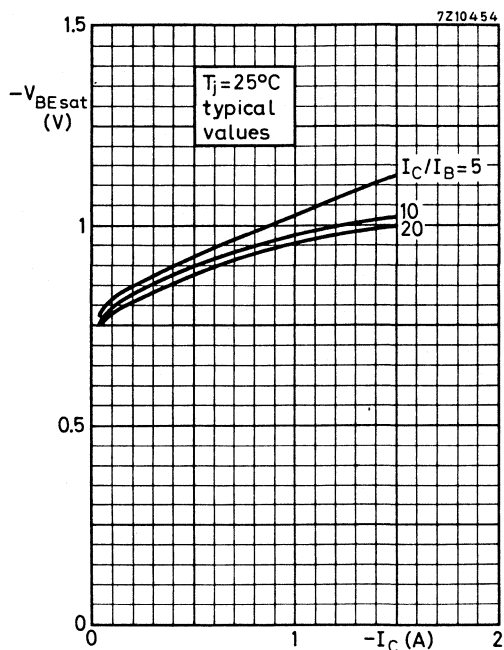

Fig. 7.

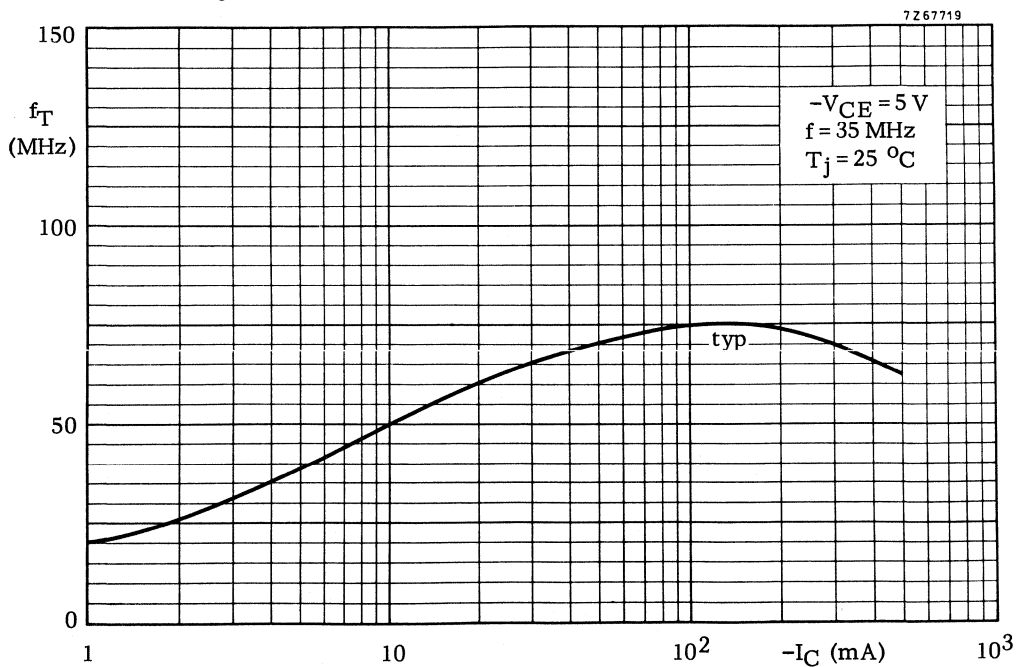

Fig. 8.



## SMALL-SIGNAL DARLINGTON TRANSISTORS

NPN epitaxial small-signal Darlington transistors, each in a plastic TO-92 envelope with an integrated diode and resistor.

They can be used for general purpose low frequency applications and as relay drivers etc.

PNP complementary types are the BC876, BC878, and BC880.

### QUICK REFERENCE DATA

			BC875	877	879
Collector-base voltage	$V_{CBO}$	max.	60	80	100 V
Collector-emitter voltage	$V_{CEO}$	max.	45	60	80 V
DC collector current	$I_C$	max.		1	A
Total power dissipation up to $T_{amb} = 25\text{ }^\circ\text{C}$	$P_{tot}$	max.		0.8	W
DC current gain $I_C = 150\text{ mA}; V_{CE} = 10\text{ V}$	$h_{FE}$	min.		1000	

### MECHANICAL DATA

Dimensions in mm

Fig.1 TO-92.

#### Pinning

1 = base

2 = collector

3 = emitter

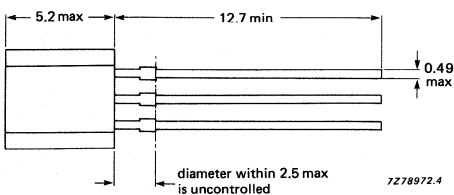
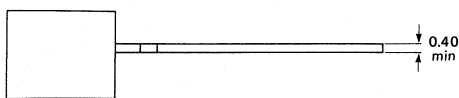
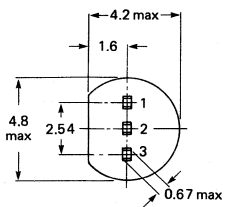
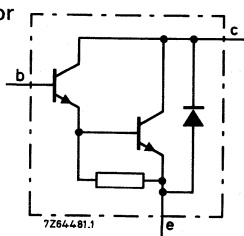

### RATINGS

Limiting values in accordance with the Absolute Maximum System (IEC 134)

			BC875	877	879
Collector-base voltage	$V_{CBO}$	max.	60	80	100 V
Collector-emitter voltage	$V_{CEO}$	max.	45	60	80 V
Emitter-base voltage	$V_{EBO}$	max.		5	V
DC collector current	$I_C$	max.		1	A
Total power dissipation up to $T_{amb} = 25\text{ }^\circ\text{C}$	$P_{tot}$	max.		0.8	W
$T_{amb} = 25\text{ }^\circ\text{C}$ (note 1)	$P_{tot}$	max.		1	W
Storage temperature range	$T_{stg}$			-65 to +150	$^\circ\text{C}$
Junction temperature	$T_j$	max.		150	$^\circ\text{C}$

### THERMAL RESISTANCE

From junction to ambient in free air	$R_{th\ j-a}$	=		156	K/W
From junction to ambient (note 1)	$R_{th\ j-a}$	=		125	K/W

### CHARACTERISTICS

$T_j = 25\text{ }^\circ\text{C}$  unless otherwise specified

			BC875	877	879
Collector-emitter breakdown voltage $I_C = 50\text{ mA}; I_B = 0$	$V_{(BR)CEO}$	min.	45	60	80 V
Collector-base breakdown voltage $I_C = 100\text{ }\mu\text{A}; I_B = 0$	$V_{(BR)CBO}$	min.	60	80	100 V
Emitter-base breakdown voltage $I_E = 100\text{ }\mu\text{A}; I_C = 0$	$V_{(BR)EBO}$	min.	5	5	5 V
Collector cut-off current $V_{CB} = 60\text{ V}; I_E = 0$	$I_{CBO}$	max.	100	—	— nA
$V_{CB} = 80\text{ V}; I_E = 0$	$I_{CBO}$	max.	—	100	— nA
$V_{CB} = 100\text{ V}; I_E = 0$	$I_{CBO}$	max.	—	—	100 nA
$V_{CE} = 22.2\text{ V}; I_B = 0$	$I_{CEO}$	max.	500	—	— nA
$V_{CE} = 30\text{ V}; I_B = 0$	$I_{CEO}$	max.	—	500	— nA
$V_{CE} = 40\text{ V}; I_B = 0$	$I_{CEO}$	max.	—	—	500 nA
Emitter cut-off current $V_{EB} = 4\text{ V}; I_C = 0$	$I_{EBO}$	max.		100	nA
DC current gain $I_C = 150\text{ mA}; V_{CE} = 10\text{ V}$	$h_{FE}$	min.		1000	
$I_C = 0.5\text{ A}; V_{CE} = 10\text{ V}$	$h_{FE}$	min.		2000	

### Note

1. Mounted on a printed circuit board, max. lead length 4 mm, mounting pad for collector lead min. 10 mm x 10 mm.

			BC875	877	879
Collector-emitter saturation voltage					
$I_C = 0.5 \text{ A}; I_B = 0.5 \text{ mA}$	$V_{CEsat}$	max.		1.3	V
$I_C = 1.0 \text{ A}; I_B = 1.0 \text{ mA}$	$V_{CEsat}$	max.		1.8	V
Base-emitter saturation voltage					
$I_C = 1.0 \text{ A}; I_B = 1.0 \text{ mA}$	$V_{BEsat}$	max.		2.2	V
Transition frequency at $T_{amb} = 25 \text{ }^\circ\text{C}$					
$I_C = 0.5 \text{ A}; V_{CE} = 5 \text{ V}; f = 35 \text{ MHz}$	$f_T$	typ.		200	MHz





## SMALL-SIGNAL DARLINGTON TRANSISTORS

PNP epitaxial small-signal Darlington transistors, each in a plastic TO-92 envelope with an integrated diode and resistor.

They can be used for general purpose low frequency applications and as relay drivers etc.

NPN complementary types are the BC875, BC877, and BC879.

### QUICK REFERENCE DATA

			BC876	878	880
Collector-base voltage	$-V_{CBO}$	max.	60	80	100 V
Collector-emitter voltage	$-V_{CEO}$	max.	45	60	80 V
DC collector current	$-I_C$	max.		1	A
Total power dissipation up to $T_{amb} = 25\text{ }^\circ\text{C}$	$P_{tot}$	max.		0.8	W
DC current gain $-I_C = 150\text{ mA}; -V_{CE} = 10\text{ V}$	$h_{FE}$	min.		1000	

### MECHANICAL DATA

Dimensions in mm

Fig.1 TO-92.

#### Pinning

- 1 = base
- 2 = collector
- 3 = emitter

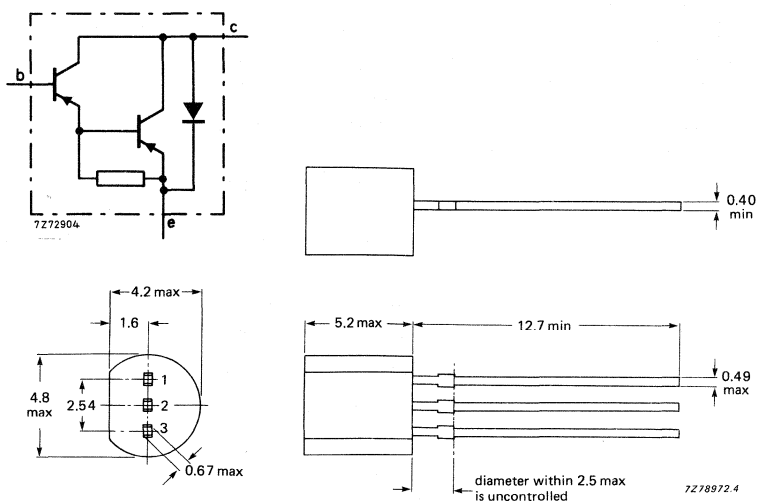

**RATINGS**

Limiting values in accordance with the Absolute Maximum System (IEC 134)

			BC876	878	880
Collector-base voltage	$-V_{CBO}$	max.	60	80	100 V
Collector-emitter voltage	$-V_{CEO}$	max.	45	60	80 V
Emitter-base voltage	$-V_{EBO}$	max.		5	V
DC collector current	$-I_C$	max.		1	A
Total power dissipation up to					
$T_{amb} = 25\text{ }^\circ\text{C}$	$P_{tot}$	max.		0.8	W
$T_{amb} = 25\text{ }^\circ\text{C}$ (note 1)	$P_{tot}$	max.		1	W
Storage temperature range	$T_{stg}$			-65 to +150	$^\circ\text{C}$
Junction temperature	$T_j$	max.		150	$^\circ\text{C}$

**THERMAL RESISTANCE**

From junction to ambient in free air	$R_{th\ j-a}$	=		156	K/W
From junction to ambient (note 1)	$R_{th\ j-a}$	=		125	K/W

**CHARACTERISTICS**

$T_j = 25\text{ }^\circ\text{C}$  unless otherwise specified

			BC876	878	880
Collector-emitter breakdown voltage					
$-I_C = 50\text{ mA}; -I_B = 0$	$-V_{(BR)CEO}$	min.	45	60	80 V
Collector-base breakdown voltage					
$-I_C = 100\text{ }\mu\text{A}; -I_B = 0$	$-V_{(BR)CBO}$	min.	60	80	100 V
Emitter-base breakdown voltage					
$-I_E = 100\text{ }\mu\text{A}; -I_C = 0$	$-V_{(BR)EBO}$	min.	5	5	5 V
Collector cut-off current					
$-V_{CB} = 60\text{ V}; -I_E = 0$	$-I_{CBO}$	max.	100	—	— nA
$-V_{CB} = 80\text{ V}; -I_E = 0$	$-I_{CBO}$	max.	—	100	— nA
$-V_{CB} = 100\text{ V}; -I_E = 0$	$-I_{CBO}$	max.	—	—	100 nA
$-V_{CE} = 22.2\text{ V}; -I_B = 0$	$-I_{CEO}$	max.	500	—	— nA
$-V_{CE} = 30\text{ V}; -I_B = 0$	$-I_{CEO}$	max.	—	500	— nA
$-V_{CE} = 40\text{ V}; -I_B = 0$	$-I_{CEO}$	max.	—	—	500 nA
Emitter cut-off current					
$-V_{EB} = 4\text{ V}; -I_C = 0$	$-I_{EBO}$	max.		100	nA
DC current gain					
$-I_C = 150\text{ mA}; -V_{CE} = 10\text{ V}$	$h_{FE}$	min.		1000	
$-I_C = 0.5\text{ A}; -V_{CE} = 10\text{ V}$	$h_{FE}$	min.		2000	

**Note**

1. Mounted on a printed circuit board, max. lead length 4 mm, mounting pad for collector lead min. 10 mm x 10 mm.



			BC876	878	880
Collector-emitter saturation voltage					
-I <sub>C</sub> = 0.5 A; -I <sub>B</sub> = 0.5 mA	-V <sub>CEsat</sub>	max.		1.3	V
-I <sub>C</sub> = 1.0 A; -I <sub>B</sub> = 1.0 mA	-V <sub>CEsat</sub>	max.		1.8	V
Base-emitter saturation voltage					
-I <sub>C</sub> = 1.0 A; -I <sub>B</sub> = 1.0 mA	-V <sub>BEsat</sub>	max.		2.2	V
Transition frequency at T <sub>amb</sub> = 25 °C					
-I <sub>C</sub> = 0.5 A; -V <sub>CE</sub> = 5 V; f = 35 MHz	f <sub>T</sub>	typ.		200	MHz



Data sheet	
status	Preliminary specification
date of issue	June 1990

# BCX22

## Silicon planar epitaxial transistor

### QUICK REFERENCE DATA

SYMBOL	PARAMETER	CONDITIONS	MIN.	TYP.	MAX.	UNIT
$V_{CE0}$	collector-emitter voltage		-	-	125	V
$I_C$	collector current	average value	-	-	800	mA
$P_{tot}$	total power dissipation	$T_{amb} \leq 25^\circ\text{C}$	-	-	450	mW
$P_{tot}$	total power dissipation	$T_{case} \leq 45^\circ\text{C}$	-	-	1.55	W
$T_j$	junction temperature		-	-	200	$^\circ\text{C}$
$h_{FE}$	DC current gain	$V_{CE} = 1\text{ V}$ $I_C = 100\text{ mA}$	63			
$V_{CEsat}$	collector-emitter saturation voltage	$I_B = 30\text{ mA}$ $I_C = 300\text{ mA}$	-	-	0.9	V
$f_T$	transition frequency	$V_{CE} = 5\text{ V}$ $I_C = 10\text{ mA}$	-	100	-	MHz

### MECHANICAL DATA

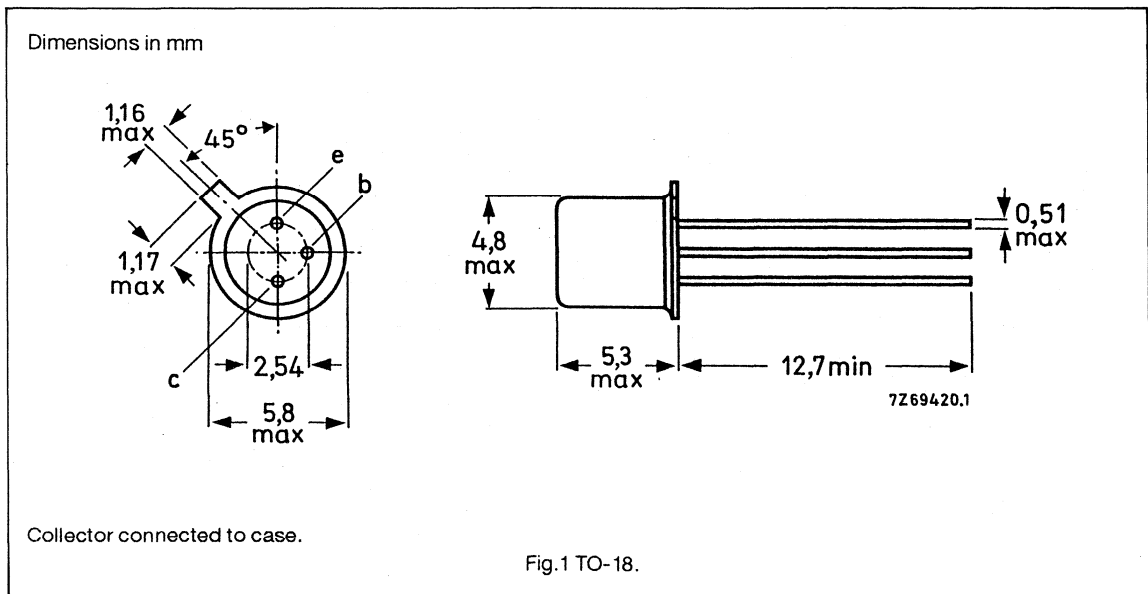

## Silicon planar epitaxial transistor

BCX22

## LIMITING VALUES

Limiting values in accordance with the Absolute Maximum System (IEC 134)

SYMBOL	PARAMETER	CONDITIONS	MIN.	MAX.	UNIT
$V_{CES}$	collector-emitter voltage	$V_{BE} = 0$	-	125	V
$V_{CEO}$	collector-emitter voltage	$I_B = 0$	-	125	V
$V_{EBO}$	emitter-base voltage	$I_C = 0$	-	5	V
$I_C$	collector current		-	800	mA
$I_{CM}$	collector current	peak value	-	1	A
$I_B$	base current		-	100	mA
$P_{tot}$	total power dissipation	$T_{amb} \leq 25\text{ }^\circ\text{C}$	-	450	mW
$P_{tot}$	total power dissipation	$T_{case} \leq 45\text{ }^\circ\text{C}$	-	1.55	W
$T_{stg}$	storage temperature range		-65	150	$^\circ\text{C}$
$T_j$	junction temperature		-	200	$^\circ\text{C}$

## THERMAL RESISTANCE

SYMBOL	PARAMETER	VALUE	UNIT
$R_{th\ j-a}$	from junction to ambient	500	K/W
$R_{th\ j-c}$	from junction to case	200	K/W

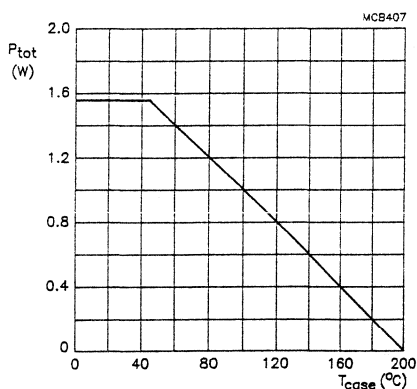

Fig.2 Total power dissipation as a function of case temperature.

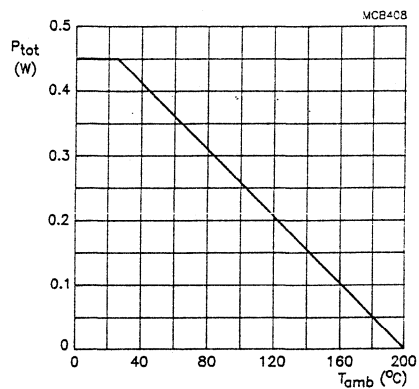

Fig.3 Total power dissipation as a function of ambient temperature.

## Silicon planar epitaxial transistor

## BCX22

## CHARACTERISTICS

$T_{amb} = 25\text{ }^{\circ}\text{C}$  unless otherwise specified.

SYMBOL	PARAMETER	CONDITIONS	MIN.	TYP.	MAX.	UNIT
$V_{(BR)CES}$	collector-emitter breakdown voltage	$V_{BE} = 0$ $I_C = 100\text{ }\mu\text{A}$	125	-	-	V
$V_{(BR)CEO}$	collector-emitter breakdown voltage	$I_B = 0$ $I_C = 10\text{ mA}$	125	-	-	V
$V_{(BR)EBO}$	emitter-base breakdown voltage	$I_E = 100\text{ }\mu\text{A}$ $I_C = 0$	5	-	-	V
$I_{CES}$	collector cut-off current	$V_{BE} = 0$ $V_{CE} = 100\text{ V}$	-	-	100	nA
$I_{CES}$	collector cut-off current	$V_{BE} = 0$ $V_{CE} = 100\text{ V}$ $T_{amb} = 150\text{ }^{\circ}\text{C}$	-	-	10	$\mu\text{A}$
$V_{CEsat}$	collector-emitter saturation voltage	$I_B = 30\text{ mA}$ $I_C = 300\text{ mA}$	-	-	0.9	V
$V_{BEsat}$	base-emitter saturation voltage	$I_B = 30\text{ mA}$ $I_C = 300\text{ mA}$	-	-	1.4	V
$h_{FE}$	DC current gain	$V_{CE} = 1\text{ V}$ $I_C = 100\text{ mA}$	63	-	-	
$h_{FE}$	DC current gain	$V_{CE} = 1\text{ V}$ $I_C = 200\text{ mA}$	40	-	-	
$f_T$	transition frequency	$V_{CE} = 5\text{ V}$ $I_C = 10\text{ mA}$ $f = 20\text{ MHz}$	-	100	-	MHz
$C_c$	collector capacitance	$V_{CB} = 10\text{ V}$ $I_E = 0$ $f = 1\text{ MHz}$	-	12	-	pF



Data sheet	
status	Preliminary specification
date of issue	June 1990

# BCX23

## Silicon planar epitaxial transistor

### QUICK REFERENCE DATA

SYMBOL	PARAMETER	CONDITIONS	MIN.	TYP.	MAX.	UNIT
$-V_{CE0}$	collector-emitter voltage		-	-	125	V
$-I_C$	collector current		-	-	800	mA
$P_{tot}$	total power dissipation	$T_{amb} \leq 25\text{ }^\circ\text{C}$	-	-	450	mW
$P_{tot}$	total power dissipation	$T_{case} \leq 45\text{ }^\circ\text{C}$	-	-	1.55	W
$T_j$	junction temperature		-	-	200	$^\circ\text{C}$
$h_{FE}$	DC current gain	$-V_{CE} = 1\text{ V}$ $-I_C = 100\text{ mA}$	63	-	-	
$-V_{CEsat}$	collector-emitter saturation voltage	$-I_B = 30\text{ mA}$ $-I_C = 300\text{ mA}$	-	-	0.9	V
$f_T$	transition frequency	$-V_{CE} = 5\text{ V}$ $-I_C = 10\text{ mA}$	-	100	-	MHz

### MECHANICAL DATA

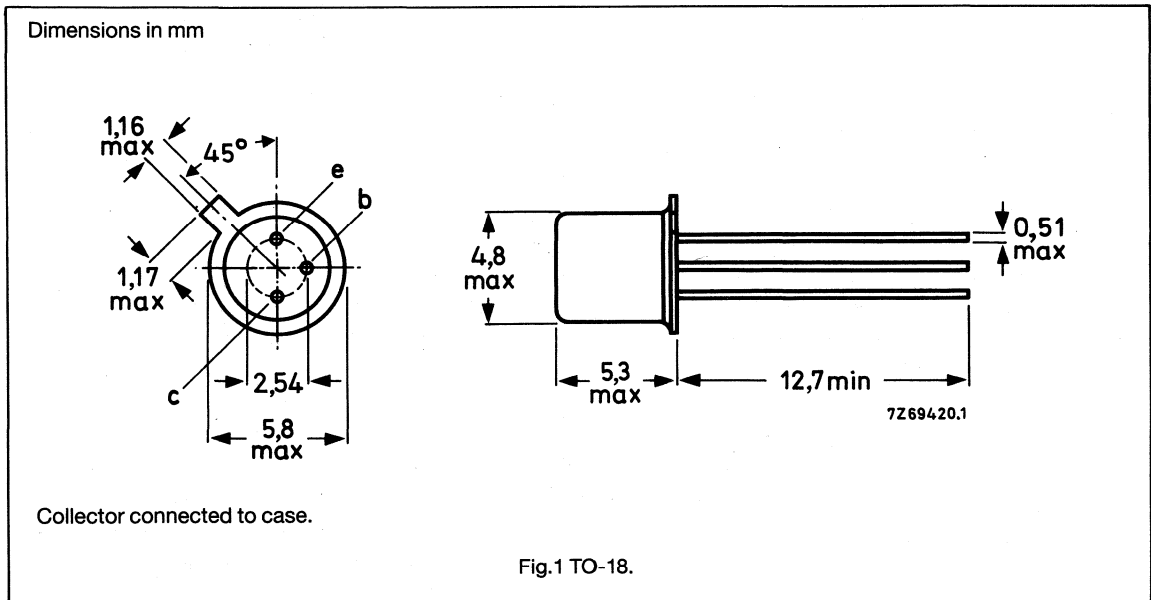

# Silicon planar epitaxial transistor

# BCX23

## LIMITING VALUES

Limiting values in accordance with the Absolute Maximum System (IEC 134)

SYMBOL	PARAMETER	CONDITIONS	MIN.	MAX.	UNIT
$-V_{CES}$	collector-emitter voltage	$V_{BE} = 0$	-	125	V
$-V_{CEO}$	collector-emitter voltage	$I_B = 0$	-	125	V
$-V_{EBO}$	emitter-base voltage	$I_C = 0$	-	5	V
$-I_C$	collector current	average value	-	800	mA
$-I_{CM}$	collector current	peak value	-	1	A
$-I_B$	base current		-	100	mA
$P_{tot}$	total power dissipation	$T_{amb} \leq 25\text{ }^\circ\text{C}$	-	450	mW
$P_{tot}$	total power dissipation	$T_{case} \leq 45\text{ }^\circ\text{C}$	-	1.55	W
$T_{stg}$	storage temperature range		-65	150	$^\circ\text{C}$
$T_j$	junction temperature		-	175	$^\circ\text{C}$

## THERMAL RESISTANCE

SYMBOL	PARAMETER	VALUE	UNIT
$R_{th\ j-a}$	from junction to ambient	500	K/W
$R_{th\ j-c}$	from junction to case	200	K/W

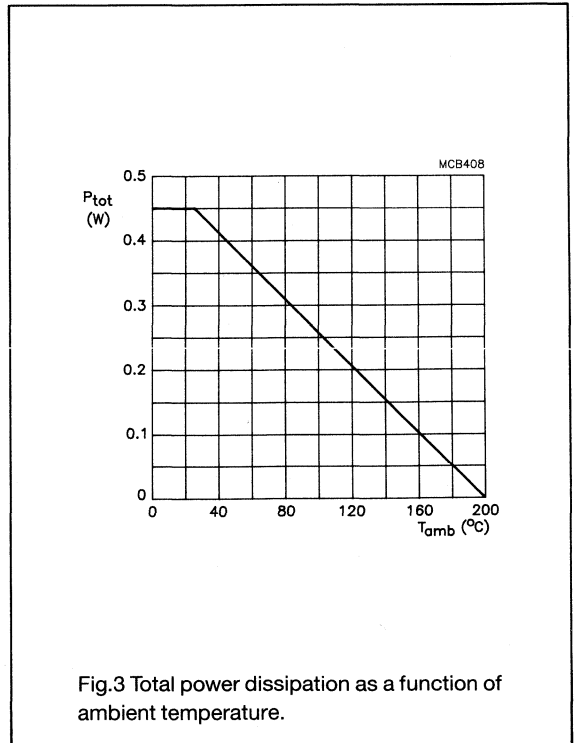
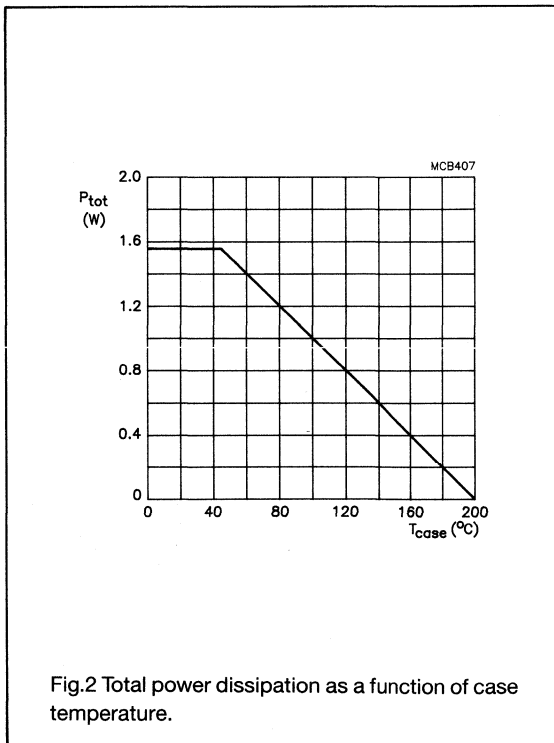



## Silicon planar epitaxial transistor

## BCX23

## CHARACTERISTICS

$T_{amb} = 25\text{ }^{\circ}\text{C}$  unless otherwise specified.

SYMBOL	PARAMETER	CONDITIONS	MIN.	TYP.	MAX.	UNIT
$-V_{(BR)CES}$	collector-emitter breakdown voltage	$V_{BE} = 0$ $-I_C = 100\text{ }\mu\text{A}$	125	-	-	V
$-V_{(BR)CEO}$	collector-emitter breakdown voltage	$I_B = 0$ $-I_C = 10\text{ mA}$	125	-	-	V
$-V_{(BR)EBO}$	emitter-base breakdown voltage	$-I_E = 100\text{ }\mu\text{A}$ $I_C = 0$	5	-	-	V
$-I_{CES}$	collector cut-off current	$V_{BE} = 0$ $-V_{CE} = 100\text{ V}$	-	-	100	nA
$-I_{CES}$	collector cut-off current	$V_{BE} = 0$ $-V_{CE} = 100\text{ V}$ $T_{amb} = 150\text{ }^{\circ}\text{C}$	-	-	10	$\mu\text{A}$
$-V_{CEsat}$	collector-emitter saturation voltage	$-I_B = 30\text{ mA}$ $-I_C = 300\text{ mA}$	-	-	0.9	V
$-V_{BEsat}$	base-emitter saturation voltage	$-I_B = 30\text{ mA}$ $-I_C = 300\text{ mA}$	-	-	1.4	V
$h_{FE}$	DC current gain	$-V_{CE} = 1\text{ V}$ $-I_C = 100\text{ mA}$	63	-	-	
$h_{FE}$	DC current gain	$-V_{CE} = 1\text{ V}$ $-I_C = 200\text{ mA}$	40	-	-	
$f_T$	transition frequency	$-V_{CE} = 5\text{ V}$ $-I_C = 10\text{ mA}$ $f = 20\text{ MHz}$	-	100	-	MHz
$C_c$	collector capacitance	$-V_{CB} = 10\text{ V}$ $I_E = 0$ $f = 1\text{ MHz}$	-	12	-	pF





## N-P-N SILICON PLANAR EPITAXIAL TRANSISTORS

N-P-N silicon planar epitaxial transistors in a plastic TO-92 envelope.

P-N-P complementary types are BCX78 and BCX79.

### QUICK REFERENCE DATA

			BCX58	BCX59
Collector-emitter voltage (open base)	$V_{CE0}$	max.	32	45 V
Collector-emitter voltage (emitter to base)	$V_{CES}$	max.	32	45 V
Emitter-base voltage (open collector)	$V_{EBO}$	max.	7	V
Collector current (peak)	$I_{CM}$	max.	200	mA
Total power dissipation up to $T_{amb} = 25\text{ }^{\circ}\text{C}$	$P_{tot}$	max.	450	mW
Junction temperature	$T_j$	max.	150	$^{\circ}\text{C}$
Transition frequency	$f_T$	>	125	MHz

### MECHANICAL DATA

Dimensions in mm

Fig. 1 TO-92.

#### Pinning

- 1 = emitter
- 2 = base
- 3 = collector

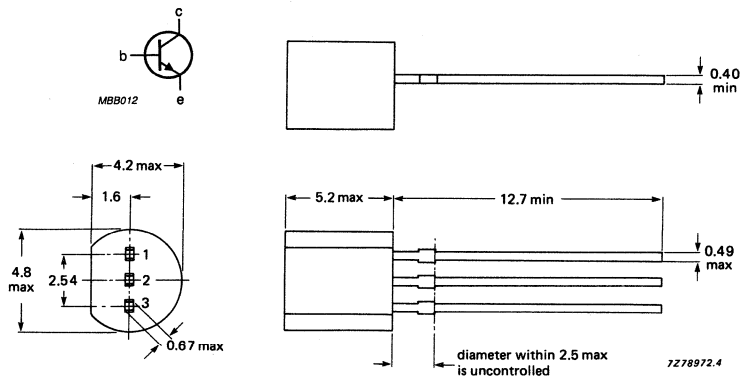

**RATINGS**

Limiting values in accordance with the Absolute Maximum System (IEC 134)

			BCX58	BCX59
Collector-emitter voltage (open base)	$V_{CEO}$	max.	32	45 V
Collector-emitter voltage (emitter to base)	$V_{CES}$	max.	32	45 V
Emitter-base voltage	$V_{EBO}$	max.	7	V
Collector current (d.c.)	$I_C$	max.	100	mA
Collector current (peak value)	$I_{CM}$	max.	200	mA
Base current (d.c.)	$I_B$	max.	50	mA
Total power dissipation up to $T_{amb} = 25\text{ }^\circ\text{C}$	$P_{tot}$	max.	450	mW
Junction temperature	$T_j$	max.	150	$^\circ\text{C}$
Storage temperature	$T_{stg}$		-55 to +150	$^\circ\text{C}$

**THERMAL RESISTANCE**

From junction to ambient in free air	$R_{th\ j-a}$	=	280	K/W
--------------------------------------	---------------	---	-----	-----

**CHARACTERISTICS**

$T_j = 25\text{ }^\circ\text{C}$  unless otherwise specified

			BCX58	BCX59
Collector-emitter current				
$V_{CE} = 32\text{ V}$	$I_{CES}$	<	10	nA
$V_{CE} = 32\text{ V}; T_j = 125\text{ }^\circ\text{C}$	$I_{CES}$	<	2,5	$\mu\text{A}$
$V_{CE} = 32\text{ V}; V_{BE} = 0,2\text{ V}; T_j = 100\text{ }^\circ\text{C}$	$I_{CEX}$	<	20	$\mu\text{A}$
Collector-emitter current				
$V_{CE} = 45\text{ V}$	$I_{CES}$	<		10 nA
$V_{CE} = T_j = 125\text{ }^\circ\text{C}$	$I_{CES}$	<		2,5 $\mu\text{A}$
$V_{CE} = 45\text{ }^\circ\text{C}; V_{BE} = 0,2\text{ V}; T_j = 100\text{ }^\circ\text{C}$	$I_{CEX}$	<		20 $\mu\text{A}$
Emitter-base current				
$V_{EBO} = 5\text{ V}$	$I_{EBO}$	<	20	20 nA
Collector-emitter breakdown voltage				
$I_C = 10\text{ mA}$	$V_{(BR)CEO}$	>	32	45 V
Emitter-base breakdown voltage				
$I_{EBO} = 1\text{ } \mu\text{A}$	$V_{(BR)EBO}$	>	7	V
Collector-emitter saturation voltage				
$I_C = 100\text{ mA}; I_B = 2,5\text{ mA}$	$V_{CEsat}$	<	0,5	V
$I_C = 100\text{ mA}; I_B = 2,5\text{ mA}$	$V_{BEsat}$	<	1,0	V
Collector-base capacitance at 1 MHz				
$V_{CBO} = 10\text{ V}$	$C_{cb}$	<	4,5	pF

		BCX58	BCX59
Emitter-base capacitance at 1 MHz $V_{EBO} = 0,5 \text{ V}$		$C_{eb}$	> 15 pF
Transition frequency at $f = 100 \text{ MHz}$ $I_C = 10 \text{ mA}; V_{CE} = 5 \text{ V}$		$f_T$	< 125 MHz
Noise figure at $f = 1 \text{ kHz}$ $I_C = 0,2 \text{ mA}; V_{CE} = 5 \text{ V}; R_S = 2 \text{ k}\Omega$		F	< 6 dB typ. 2 dB

type		BCX58, BCX59				BCX58 BCX59
hFE	group	7	8	9	10	
$V_{CE}$ (V)	$I_C$ (mA)	hFE	hFE	hFE	hFE	$V_{BE}$ (V)
5	0,01	78	145 (>20)	220 (>40)	300 (>100)	0,5
5	2	170 (120 – 220)	250 (180 – 310)	350 (250 – 460)	500 (380 – 630)	0,62 (0,55 – 0,7)
1	10	190 (>80)	260 (120 – 400)	380 (160 – 630)	550 (240 – 1000)	0,7
1	100	>40	>45	>60	>60	0,83





## P-N-P SILICON PLANAR EPITAXIAL TRANSISTORS

P-N-P silicon planar epitaxial transistors in a plastic TO-92 envelope.

N-P-N complementary types are BCX58 and BCX59.

### QUICK REFERENCE DATA

			BCX78	BCX79
Collector-emitter voltage (open base)	$-V_{CEO}$	max.	32	45 V
Collector-emitter voltage (emitter to base)	$-V_{CES}$	max.	32	45 V
Emitter-base voltage (open collector)	$-V_{EBO}$	max.	5	V
Collector current (peak)	$-I_{CM}$	max.	200	mA
Total power dissipation up to $T_{amb} = 25\text{ }^{\circ}\text{C}$	$P_{tot}$	max.	450	mW
Junction temperature	$T_j$	max.	150	$^{\circ}\text{C}$
Transition frequency	$f_T$	>	200	MHz

### MECHANICAL DATA

Dimensions in mm

Fig. 1 TO-92.

#### Pinning

- 1 = emitter
- 2 = base
- 3 = collector

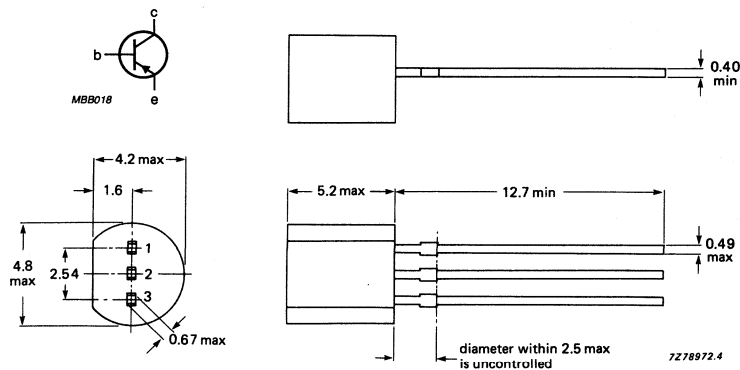

**RATINGS**

Limiting values in accordance with the Absolute Maximum System (IEC 134)

			BCX78	BCX79
Collector-emitter voltage (open base)	$-V_{CEO}$	max.	32	45 V
Collector-emitter voltage (emitter to base)	$-V_{CES}$	max.	32	45 V
Emitter-base voltage	$-V_{EBO}$	max.	5	V
Collector current (d.c.)	$-I_C$	max.	100	mA
Collector current (peak value)	$-I_{CM}$	max.	200	mA
Base current (d.c.)	$-I_B$	max.	50	mA
Total power dissipation up to $T_{amb} = 25\text{ }^\circ\text{C}$	$P_{tot}$	max.	450	mW
Junction temperature	$T_j$	max.	150	$^\circ\text{C}$
Storage temperature	$T_{stg}$		-55 to +150	$^\circ\text{C}$

**THERMAL RESISTANCE**

From junction to ambient in free air	$R_{th\ j-a}$	max.	280	K/W
--------------------------------------	---------------	------	-----	-----

**CHARACTERISTICS**

$T_j = 25\text{ }^\circ\text{C}$  unless otherwise specified

			BCX78	BCX79
Collector-emitter current				
$-V_{CE} = 32\text{ V}$	$-I_{CES}$	<	10	nA
$-V_{CE} = 32\text{ V}; T_j = 125\text{ }^\circ\text{C}$	$-I_{CES}$	<	2,5	$\mu\text{A}$
$-V_{CE} = 32\text{ V}; -V_{BE} = 0,2\text{ V}; T_j = 100\text{ }^\circ\text{C}$	$-I_{CEX}$	<	20	$\mu\text{A}$
Collector-emitter current				
$-V_{CE} = 45\text{ V}$	$-I_{CES}$	<		10 nA
$-V_{CE} = T_j = 125\text{ }^\circ\text{C}$	$-I_{CES}$	<		2,5 $\mu\text{A}$
$-V_{CE} = 45\text{ }^\circ\text{C}; -V_{BE} = 0,2\text{ V}; T_j = 100\text{ }^\circ\text{C}$	$-I_{CEX}$	<		20 $\mu\text{A}$
Emitter-base current				
$-V_{EBO} = 4\text{ V}$	$-I_{EBO}$	<	20	20 nA
Collector-emitter breakdown voltage				
$-I_C = 10\text{ mA}$	$-V_{(BR)CEO}$	>	32	45 V
Emitter-base breakdown voltage				
$-I_{EBO} = 1\text{ }\mu\text{A}$	$-V_{(BR)EBO}$	>	5	V
Collector-emitter saturation voltage				
$-I_C = 100\text{ mA}; -I_B = 2,5\text{ mA}$	$-V_{CEsat}$	<	0,6	V
$-I_C = 100\text{ mA}; -I_B = 2,5\text{ mA}$	$-V_{BEsat}$	<	1,0	V
Collector-base capacitance at 1 MHz				
$-V_{CBO} = 10\text{ V}$	$C_{cb}$	<	4,5	pF
Emitter-base capacitance at 1 MHz				
$-V_{EBO} = 0,5\text{ V}$	$C_{eb}$	<	15	pF



		BCX78	BCX79
Transition frequency at $f = 100$ MHz $-I_C = 10$ mA; $-V_{CE} = 5$ V		$f_T >$	200 MHz
Noise figure at $f = 1$ kHz $-I_C = 0,2$ mA; $-V_{CE} = 5$ V; $R_S = 2$ k $\Omega$		$F <$ typ.	6 dB 2 dB

type		BCX78, BCX79				BCX78
hFE group		7	8	9	10	BCX79
$-V_{CE}$ (V)	$-I_C$ (mA)	hFE	hFE	hFE	hFE	$-V_{BE}$ (V)
5	0,01	140	200 (>30)	270 (>40)	340 (>100)	0,55
5	2	170 (120 - 220)	250 (180 - 310)	350 (250 - 460)	500 (380 - 630)	0,65 (0,6 - 0,7)
1	10	180 (>80)	260 (120 - 400)	360 (160 - 630)	500 (240 - 1000)	0,68
1	100	>40	>45	>60	>60	0,76 (<0,9)





## SILICON PLANAR EPITAXIAL TRANSISTORS

N-P-N transistors in TO-18 metal envelopes with the collector connected to the case.

They are intended for general purpose very high-gain low level and low-noise applications. Moreover, they are also suitable for low-speed switching applications.

### QUICK REFERENCE DATA

		BCY56	BCY57	
Collector-base voltage (open emitter)	$V_{CBO}$	max. 45	25	V
Collector-emitter voltage (open base)	$V_{CEO}$	max. 45	20	V
Collector current (d.c.)	$I_C$	max. 100	100	mA
Total power dissipation up to $T_{amb} = 25\text{ }^\circ\text{C}$	$P_{tot}$	max. 300	300	mW
Junction temperature	$T_j$	max. 175	175	$^\circ\text{C}$
D.C. current gain at $T_j = 25\text{ }^\circ\text{C}$ $I_C = 10\text{ }\mu\text{A}; V_{CE} = 5\text{ V}$	$h_{FE}$	> 40	100	
$I_C = 2\text{ mA}; V_{CE} = 5\text{ V}$	$h_{FE}$	> 100 < 450	200 800	
Transition frequency $I_C = 0,5\text{ mA}; V_{CE} = 5\text{ V}$	$f_T$	typ. 85	100	MHz
Noise figure at $R_S = 2\text{ k}\Omega$ $I_C = 200\text{ }\mu\text{A}; V_{CE} = 5\text{ V}$ $f = 30\text{ Hz to } 15,7\text{ kHz}$	F	typ. < 1,5 < 5,0	1,5 5,0	dB

### MECHANICAL DATA

Dimensions in mm

Fig. 1 TO-18.

Collector connected to case

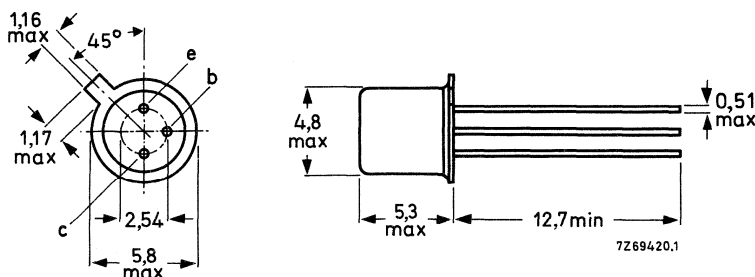

Accessories 56246 (distance disc).

Qualification approved to CECC 50 002-164

**RATINGS (Limiting values)\***

			<b>BCY56</b>	<b>BCY57</b>	
Collector-base voltage (open emitter)	$V_{CBO}$	max.	45	25	V
Collector-emitter voltage (open base)	$V_{CEO}$	max.	45	20	V
Emitter-base voltage (open collector)	$V_{EBO}$	max.	5	5	V
Collector current (d.c.)	$I_C$	max.	100		mA
Collector current (peak value)	$I_{CM}$	max.	100		mA
Total power dissipation up to $T_{amb} = 25\text{ }^\circ\text{C}$	$P_{tot}$	max.	300		mW
Storage temperature range	$T_{stg}$		-65 to + 150		$^\circ\text{C}$
Junction temperature	$T_j$	max.	175		$^\circ\text{C}$

**THERMAL RESISTANCE**

From junction to ambient in free air	$R_{thj-a}$	=	0,5		K/mW
From junction to case	$R_{thj-c}$	=	0,2		K/mW

**CHARACTERISTICS**

$T_j = 25\text{ }^\circ\text{C}$  unless otherwise specified

Collector cut-off current $I_E = 0; V_{CB} = 20\text{ V}$	$I_{CBO}$	<	100		nA
Emitter cut-off current $I_C = 0; V_{EB} = 5\text{ V}$	$I_{EBO}$	<	100		nA
Base-emitter voltage** $I_C = 2\text{ mA}; V_{CE} = 5\text{ V}$	$V_{BE}$	typ.	650		mV
			600 to 700		mV
Collector-emitter saturation voltage $I_C = 10\text{ mA}; I_B = 1\text{ mA}$	$V_{CEsat}$	typ.	80		mV
$I_C = 100\text{ mA}; I_B = 10\text{ mA}$	$V_{CEsat}$	typ.	200		mV

\* Limiting values according to the Absolute Maximum System as defined in IEC publication 134.

\*\*  $V_{BE}$  decreases with about 2 mV/K at increasing temperature.

	BCY56	BCY57
D.C. current gain		
$I_C = 10 \mu\text{A}; V_{CE} = 5 \text{ V}$	$h_{FE} > 40$	100
$I_C = 2 \text{ mA}; V_{CE} = 5 \text{ V}$	$h_{FE}$ typ. 200 100 to 450	400 200 to 800
$I_C = 10 \text{ mA}; V_{CE} = 5 \text{ V}$	$h_{FE} > 100$	200
Transition frequency		
$I_C = 0,5 \text{ mA}; V_{CE} = 5 \text{ V}$	$f_T$ typ. 85	100 MHz
$I_C = 10 \text{ mA}; V_{CE} = 5 \text{ V}$	$f_T$ typ. 250	350 MHz
h parameters at $f = 1 \text{ kHz}$		
$I_C = 2 \text{ mA}; V_{CE} = 5 \text{ V}$		
Input impedance	$h_{ie}$ typ. 3,5	7,5 $k\Omega$
Reverse voltage transfer	$h_{re}$ typ. 1,75	3,5 $10^{-4}$
Small signal current gain	$h_{fe}$ typ. 250 125 to 500	500 240 to 900
Output admittance	$h_{oe}$ typ. 17,5	35 $\mu\text{S}$
Collector capacitance at $f = 1 \text{ MHz}$		
$I_E = I_e = 0; V_{CB} = 5 \text{ V}$	$C_c$ typ. 4,5	4,5 pF
Noise figure		
$I_C = 200 \mu\text{A}; V_{CE} = 5 \text{ V}; R_S = 2 \text{ k}\Omega$		
$f = 30 \text{ Hz to } 15,7 \text{ kHz}$	F typ. 1,5 < 5	1,5 dB 5 dB





## SILICON PLANAR EPITAXIAL TRANSISTORS

N-P-N transistors in TO-18 metal envelopes with the collector connected to the case, for use in amplifier and switching applications.

### QUICK REFERENCE DATA

		BCY58	BCY59		
Collector-emitter voltage (open base)	$V_{CE0}$ max.	32	45	V	
Collector current (d.c.)	$I_C$ max.	200	200	mA	
Total power dissipation up to $T_{amb} = 45^\circ\text{C}$ up to $T_{case} = 45^\circ\text{C}$	$P_{tot}$ max.	330	330	mW	
	$P_{tot}$ max.	1000	1000	mW	
Junction temperature	$T_j$ max.	200	200	$^\circ\text{C}$	
		<b>BCY58-VII</b>	<b>VIII</b>	<b>IX</b>	<b>X</b>
		<b>BCY59-VII</b>	<b>VIII</b>	<b>IX</b>	<b>X</b>
Small-signal current gain at $T_j = 25^\circ\text{C}$ $I_C = 2\text{ mA}$ ; $V_{CE} = 5\text{ V}$ ; $f = 1\text{ kHz}$	$h_{fe} >$	125	175	250	350
	$h_{fe} <$	250	350	500	700
Transition frequency at $f = 100\text{ MHz}$ $I_C = 10\text{ mA}$ ; $V_{CE} = 5\text{ V}$	$f_T >$	150		MHz	
	F	typ.		2 dB	

### MECHANICAL DATA

Dimensions in mm

Fig. 1 TO-18.

Collector connected to case

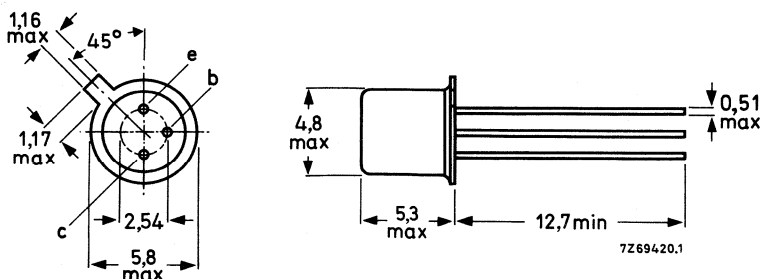

Accessories 56246 (distance disc).

Qualification approved to CECC 50 002-292/293

**RATINGS**

Limiting values in accordance with the Absolute Maximum System (IEC 134)

		<b>BCY58</b>	<b>BCY59</b>	
Collector emitter voltage ( $V_{BE} = 0$ )	$V_{CES}$	max. 32	45	V
Collector-emitter voltage (open base)	$V_{CEO}$	max. 32	45	V
Emitter-base voltage (open collector)	$V_{EBO}$	max. 7	7	V
Collector current	$I_C$	max. 200		mA
Base current	$I_B$	max. 50		mA
Total power dissipation up to $T_{case} = 45\text{ }^{\circ}\text{C}$	$P_{tot}$	max. 1000		mW
Storage temperature range	$T_{stg}$		-65 to +150	$^{\circ}\text{C}$
Junction temperature	$T_j$	max. 200		$^{\circ}\text{C}$
<b>THERMAL RESISTANCE</b>				
From junction to ambient in free air	$R_{th\ j-a}$	=	0,45	K/mW
From junction to case	$R_{th\ j-c}$	=	0,15	K/mW



## CHARACTERISTICS

 $T_j = 25\text{ }^\circ\text{C}$  unless otherwise specified

		BCY58	BCY59
Collector cut-off currents			
$V_{CE} = 32\text{ V}; V_{BE} = 0$	$I_{CES}$	< 10	nA
$V_{CE} = 45\text{ V}; V_{BE} = 0$	$I_{CES}$	<	10 nA
$V_{CE} = 32\text{ V}; V_{BE} = 0; T_j = 150\text{ }^\circ\text{C}$	$I_{CES}$	< 10	$\mu\text{A}$
$V_{CE} = 45\text{ V}; V_{BE} = 0; T_j = 150\text{ }^\circ\text{C}$	$I_{CES}$	<	10 $\mu\text{A}$
Emitter cut-off current			
$I_C = 0; V_{EB} = 5\text{ V}$	$I_{EBO}$	< 10	10 nA
Collector-emitter breakdown voltage			
$I_B = 0; I_C = 2\text{ mA}$	$V_{(BR)CEO}$	> 32	45 V
Emitter-base breakdown voltage			
$I_C = 0; I_E = 1\text{ }\mu\text{A}$	$V_{(BR)EBO}$	> 7	7 V
Base emitter voltage			
$I_C = 10\text{ }\mu\text{A}; V_{CE} = 5\text{ V}$	$V_{BE}$	typ.	0,5 V
$I_C = 20\text{ }\mu\text{A}; V_{CE} = V_{CEO\text{ max}}; T_j = 100\text{ }^\circ\text{C}$	$V_{BE}$	>	0,2 V
$I_C = 2\text{ mA}; V_{CE} = 5\text{ V}$	$V_{BE}$	typ.	0,62 V
$I_C = 10\text{ mA}; V_{CE} = 1\text{ V}$	$V_{BE}$	typ.	0,55 to 0,70 V
$I_C = 100\text{ mA}; V_{CE} = 1\text{ V}$	$V_{BE}$	typ.	0,70 V
	$V_{BE}$	typ.	0,76 V
Saturation voltages			
$I_C = 10\text{ mA}; I_B = 0,25\text{ mA}$	$V_{CEsat}$	typ.	100 mV
			50 to 350 mV
	$V_{BEsat}$	typ.	700 mV
			600 to 850 mV
$I_C = 100\text{ mA}; I_B = 2,5\text{ mA}$	$V_{CEsat}$	typ.	250 mV
			150 to 700 mV
		typ.	875 mV
			750 to 1200 mV
Collector capacitance at $f = 1\text{ MHz}$			
$I_E = I_e = 0; V_{CB} = 10\text{ V}$	$C_c$	<	5,0 pF
Emitter capacitance at $f = 1\text{ MHz}$			
$I_C = I_c = 0; V_{EB} = 0,5\text{ V}$	$C_e$	<	15 pF
Transition frequency at $f = 100\text{ MHz}$			
$I_C = 10\text{ mA}; V_{CE} = 5\text{ V}$	$f_T$	>	150 MHz
Noise figure at $R_S = 2\text{ k}\Omega$			
$I_C = 200\text{ }\mu\text{A}; V_{CE} = 5\text{ V}$			
$f = 1\text{ kHz}; B = 200\text{ Hz}$	F	typ.	2 dB
		<	6 dB

CHARACTERISTICS (continued)

		BCY58VII BCY59VII	BCY58VIII BCY59VIII	BCY58IX BCY59IX	BCY58X BCY59X
D.C. current gain $I_C = 10 \mu\text{A}; V_{CE} = 5 \text{ V}$	$h_{FE}$	> — typ. 20	20 95	40 190	100 300
	$I_C = 2 \text{ mA}; V_{CE} = 5 \text{ V}$	> 120 typ. 170 < 220	180 250 310	250 350 460	380 500 630
$I_C = 10 \text{ mA}; V_{CE} = 1 \text{ V}$	$h_{FE}$	> 80 typ. 250 < —	120 300 400	160 390 630	240 550 1000
	$I_C = 100 \text{ mA}; V_{CE} = 1 \text{ V}$	$h_{FE}$	> 40	45	60
h parameters at $f = 1 \text{ kHz}$ $I_C = 2 \text{ mA}; V_{CE} = 5 \text{ V}$					
Input impedance	$h_{ie}$	typ. 2,7	3,6	4,5	7,5 $\text{k}\Omega$
Reverse voltage transfer ratio	$h_{re}$	typ. 1,5	2	3	3 $10^{-4}$
Small signal current gain	$h_{fe}$	typ. 200	260	330	520
Output admittance	$h_{oe}$	typ. 18	24	30	50 $\mu\text{S}$

Switching times

$I_C = 10 \text{ mA}; I_B = 1 \text{ mA}; -I_{BM} = 1 \text{ mA}$   
 $R_1 = 5 \text{ k}\Omega; R_L = 990 \Omega$   
 $V_{BB} = 3,6 \text{ V}$

delay time	$t_d$	typ.	35 ns
rise time	$t_r$	typ.	50 ns
turn on time	$t_{on}$	typ.	85 ns
		<	150 ns
storage time	$t_s$	typ.	400 ns
fall time	$t_f$	typ.	80 ns
turn off time	$t_{off}$	typ.	480 ns
		<	800 ns

$I_C = 100 \text{ mA}; I_B = 10 \text{ mA}; -I_{BM} = 10 \text{ mA}$   
 $R_1 = 500 \Omega; R_2 = 700 \Omega; R_L = 98 \Omega$   
 $V_{BB} = 5 \text{ V}$

delay time	$t_d$	typ.	5 ns
rise time	$t_r$	typ.	50 ns
turn on time	$t_{on}$	typ.	55 ns
		<	150 ns
storage time	$t_s$	typ.	250 ns
fall time	$t_f$	typ.	200 ns
turn off time	$t_{off}$	typ.	450 ns
		<	800 ns

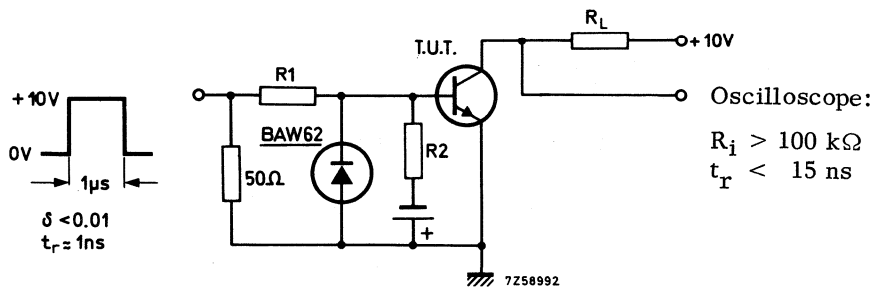

Fig. 2 Test circuit for switching times.

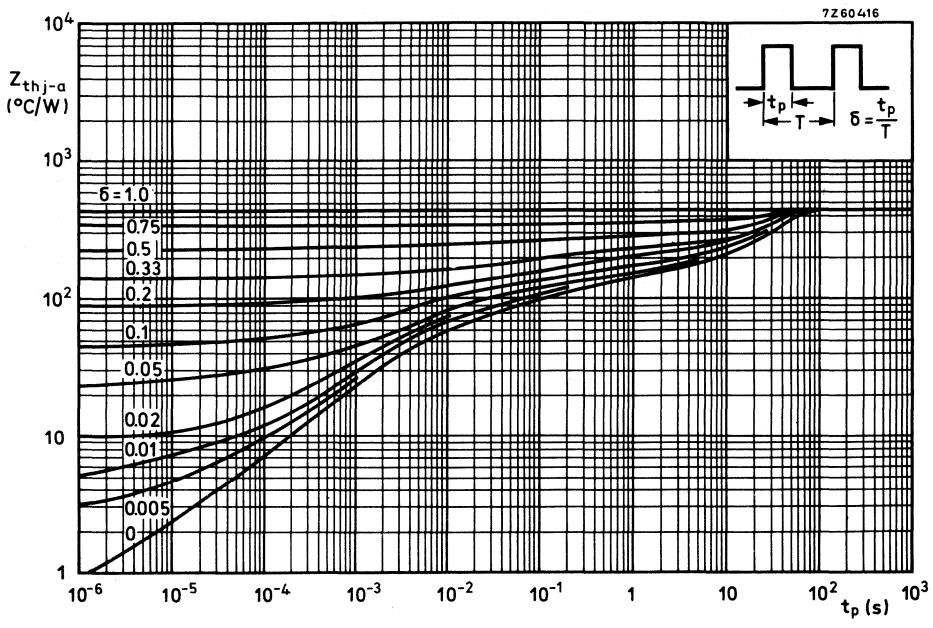

Fig. 3.

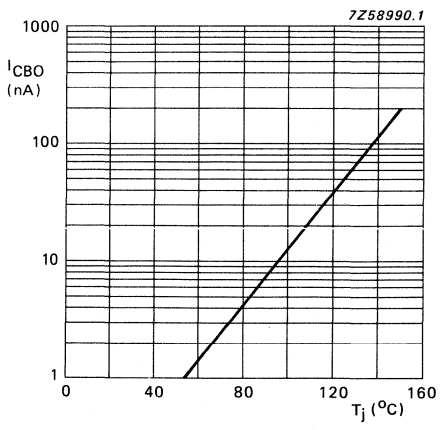

Fig. 4  $V_{CB} = 32$  V (BCY58); 45 V (BCY59); typical values.

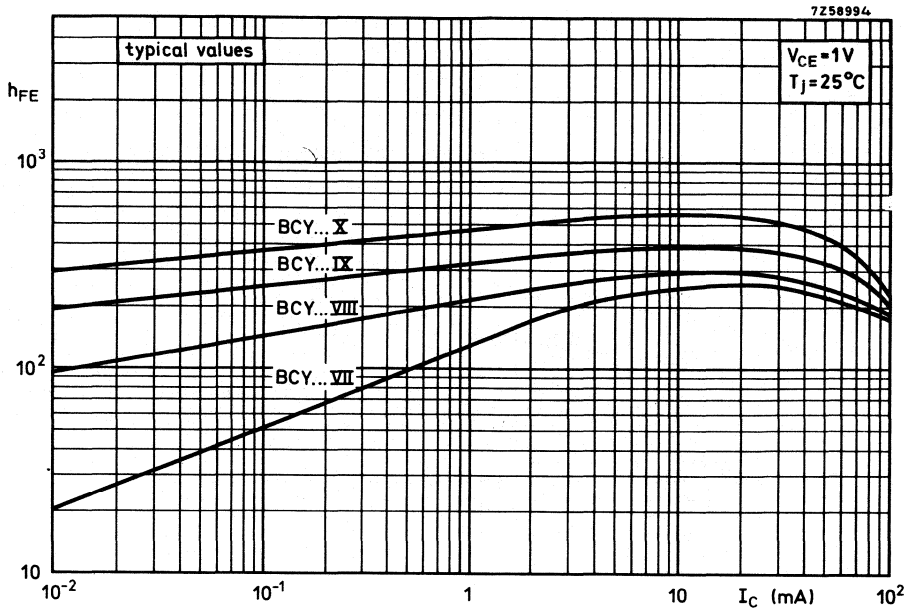

Fig. 5.

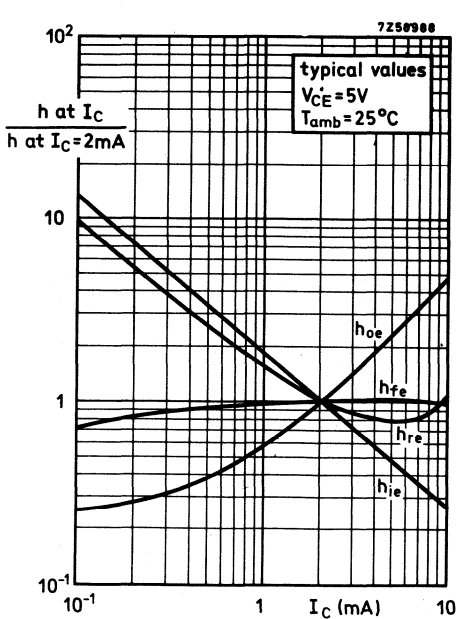

Fig. 6.

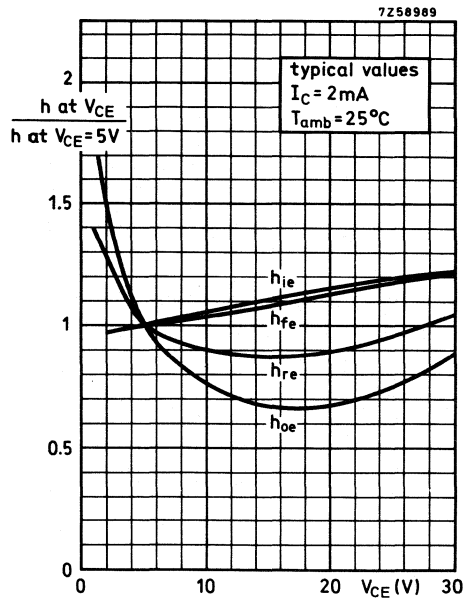

Fig. 7.

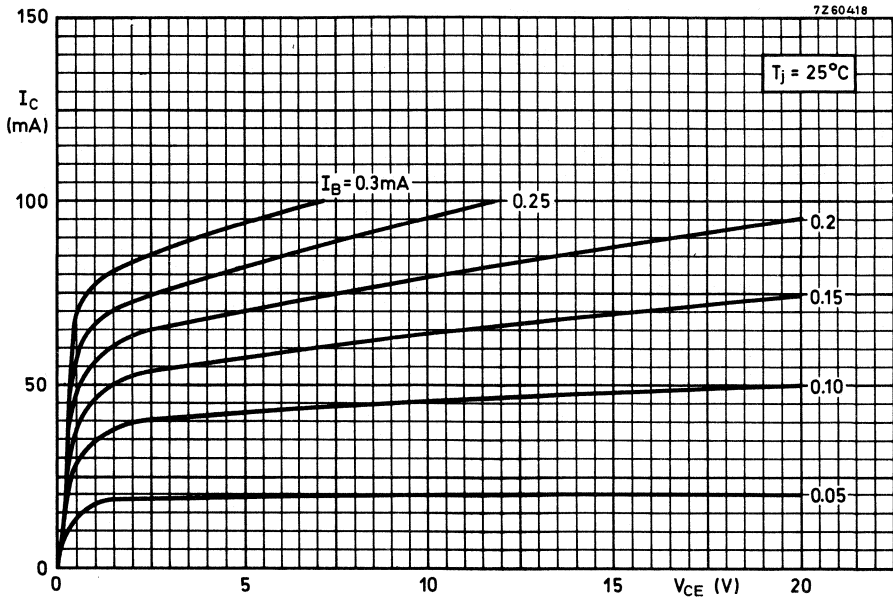

Fig. 8.

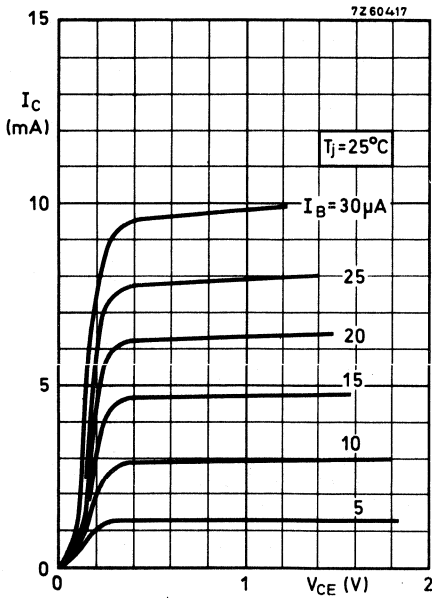

Fig. 9.

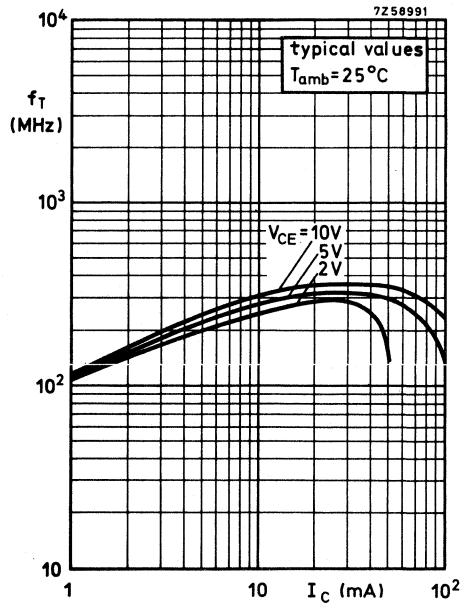

Fig. 10.

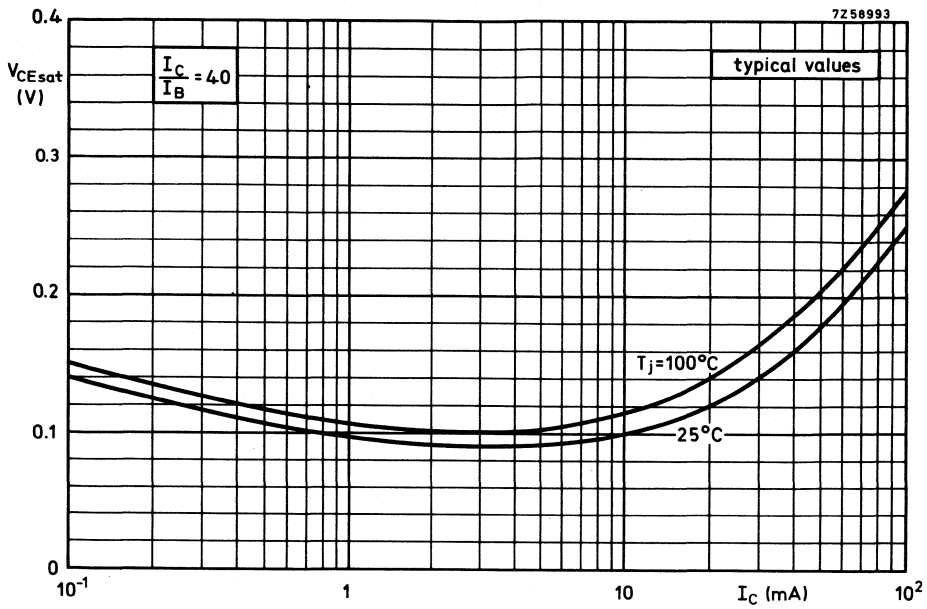

Fig. 11.

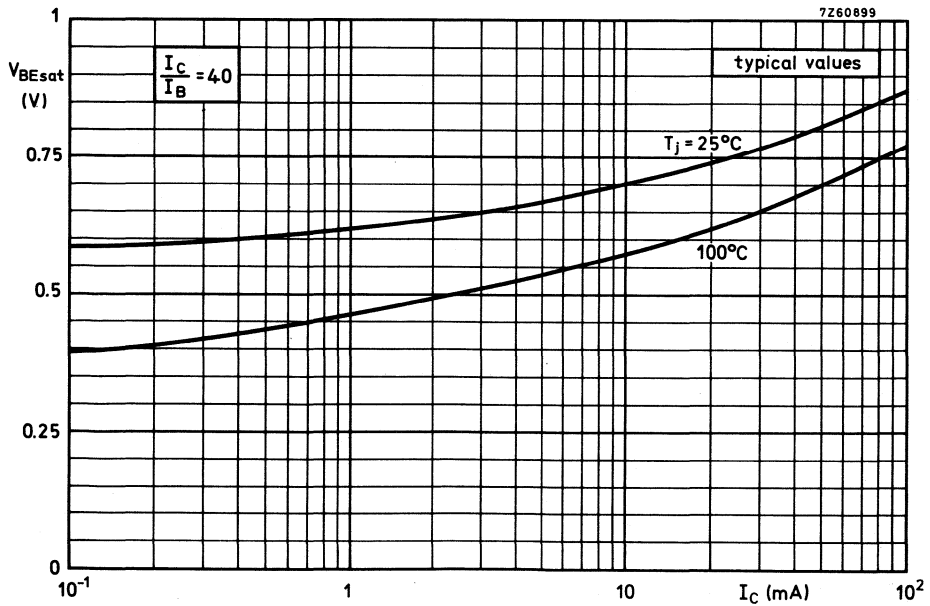

Fig. 12.







## SILICON PLANAR EPITAXIAL TRANSISTOR

N-P-N transistor in TO-18 metal envelope with the collector connected to the case and designed for use in amplifier and switching applications.

### QUICK REFERENCE DATA

Collector-emitter voltage (open base)	$V_{CEO}$	max.	60	V																
Collector current (d.c.)	$I_C$	max.	200	mA																
Total power dissipation up to $T_{case} = 45\text{ }^\circ\text{C}$ up to $T_{amb} = 45\text{ }^\circ\text{C}$	$P_{tot}$	max.	1000	mW																
	$P_{tot}$	max.	330	mW																
Junction temperature	$T_j$	max.	200	$^\circ\text{C}$																
Small-signal current gain at $f = 1\text{ kHz}$ $I_C = 2\text{ mA}; V_{CE} = 5\text{ V}$	<table border="1"> <thead> <tr> <th></th> <th>BCY65-VII</th> <th>VIII</th> <th>IX</th> </tr> </thead> <tbody> <tr> <td><math>h_{fe}</math></td> <td><math>\geq 125</math></td> <td>175</td> <td>250</td> </tr> <tr> <td></td> <td>typ. 200</td> <td>260</td> <td>330</td> </tr> <tr> <td></td> <td><math>\geq 250</math></td> <td>350</td> <td>500</td> </tr> </tbody> </table>					BCY65-VII	VIII	IX	$h_{fe}$	$\geq 125$	175	250		typ. 200	260	330		$\geq 250$	350	500
		BCY65-VII	VIII	IX																
	$h_{fe}$	$\geq 125$	175	250																
		typ. 200	260	330																
	$\geq 250$	350	500																	
Transition frequency at $f = 100\text{ MHz}$ $I_C = 10\text{ mA}; V_{CE} = 5\text{ V}$	$f_T$	$\geq$	125	MHz																
Noise figure at $R_S = 2\text{ k}\Omega$ $I_C = 200\text{ }\mu\text{A}; V_{CE} = 5\text{ V};$ $f = 1\text{ kHz}; B = 200\text{ Hz}$	F	$\leq$	6	dB																

### MECHANICAL DATA

Dimensions in mm

Fig. 1 TO-18.

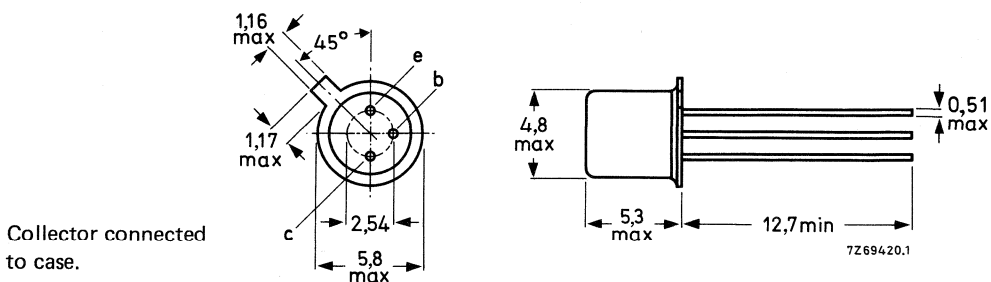

## RATINGS (up to $T_{j\ max}$ )

Limiting values in accordance with the Absolute Maximum System (IEC 134)

Collector-emitter voltage

$V_{BE} = 0$   
open base

$V_{CES}$  max. 60 V

$V_{CEO}$  max. 60 V

Emitter-base voltage (open collector)

$V_{EBO}$  max. 7 V

Collector current (d.c.)

$I_C$  max. 200 mA

Base current (d.c.)

$I_B$  max. 50 mA

Total power dissipation

up to  $T_{case} = 45\ ^\circ C$

$P_{tot}$  max. 1000 mW

up to  $T_{amb} = 45\ ^\circ C$

$P_{tot}$  max. 330 mW

Junction temperature

$T_j$  max. 200  $^\circ C$

Storage temperature range

$T_{stg}$  -65 to + 150  $^\circ C$

## THERMAL RESISTANCE

From junction to ambient

$R_{th\ j-a}$  max. 0,45 K/W

From junction to case

$R_{th\ j-c}$  max. 0,15 K/W

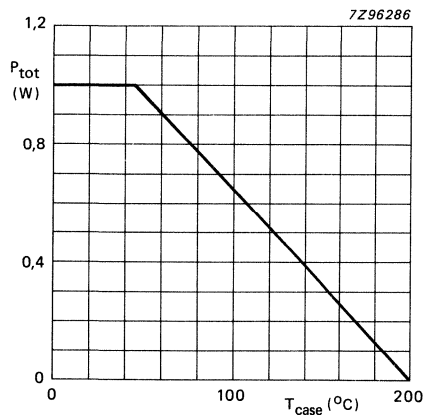

Fig. 2 Total power dissipation versus case temperature.

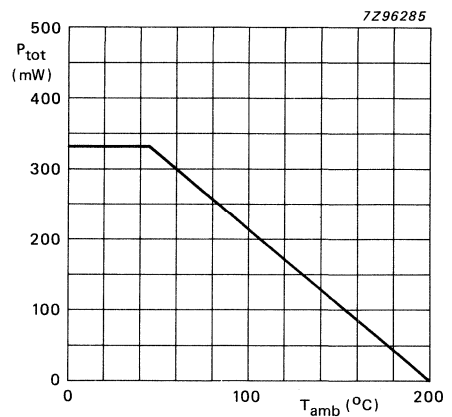

Fig. 3 Total power dissipation versus ambient temperature.

## CHARACTERISTICS

$T_{amb} = 25\text{ }^{\circ}\text{C}$  unless indicated otherwise

Collector cut-off currents

$$V_{CE} = 60\text{ V}; V_{BE} = 0$$

$$I_{CES} \leq 10\text{ nA}$$

$$V_{CE} = 60\text{ V}; V_{BE} = 0; T_{amb} = 150\text{ }^{\circ}\text{C}$$

$$I_{CES} \leq 10\text{ }\mu\text{A}$$

$$V_{CE} = 60\text{ V}; V_{BE} = 0,2\text{ V}; T_{amb} = 100\text{ }^{\circ}\text{C}$$

$$I_{CEX} \leq 20\text{ }\mu\text{A}$$

Emitter cut-off current

$$V_{EB} = 5\text{ V}; I_C = 0$$

$$I_{BEO} \leq 10\text{ nA}$$

Collector-emitter breakdown voltage

$$I_B = 0; I_C = 2\text{ mA}$$

$$V_{(BR)CEO} \geq 60\text{ V}$$

Emitter-base breakdown voltage

$$I_C = 0; I_E = 1\text{ }\mu\text{A}$$

$$V_{(BR)EBO} \geq 7\text{ V}$$

Base-emitter voltage

$$V_{CE} = 5\text{ V}; I_C = 10\text{ }\mu\text{A}$$

$$V_{BE} \text{ typ. } 500\text{ mV}$$

$$V_{CE} = 5\text{ V}; I_C = 2\text{ mA}$$

$$550\text{ to }700\text{ mV}$$

$$V_{CE} = 1\text{ V}; I_C = 10\text{ mA}$$

$$V_{BE} \text{ typ. } 700\text{ mV}$$

$$V_{CE} = 1\text{ V}; I_C = 50\text{ mA}$$

$$V_{BE} \text{ typ. } 760\text{ mV}$$

Saturation voltages

$$I_C = 10\text{ mA}; I_B = 0,25\text{ mA}$$

$$V_{CEsat} \leq 350\text{ mV}$$

$$V_{BEsat} \leq 600\text{ to }850\text{ mV}$$

$$I_C = 50\text{ mA}; I_B = 1,25\text{ mA}$$

$$V_{CEsat} \leq 700\text{ mV}$$

$$V_{BEsat} \leq 1200\text{ mV}$$

Transition frequency at  $f = 100\text{ MHz}$

$$I_C = 10\text{ mA}; V_{CE} = 5\text{ V}$$

$$f_T \geq 125\text{ MHz}$$

Noise figure at  $R_S = 2\text{ k}\Omega$

$$I_C = 200\text{ }\mu\text{A}; V_{CE} = 5\text{ V};$$

$$f = 1\text{ kHz}; B = 200\text{ Hz}$$

$$F \leq 6\text{ dB}$$

Collector capacitance at  $f = 1\text{ MHz}$

$$V_{CB} = 10\text{ V}; I_E = 0$$

$$C_c \leq 6\text{ pF}$$

Emitter capacitance at  $f = 1\text{ MHz}$

$$V_{EB} = 0,5\text{ V}; I_C = 0$$

$$C_e \leq 15\text{ pF}$$

D.C. current gain

$$V_{CE} = 5\text{ V}; I_C = 10\text{ }\mu\text{A}$$

		BCY65-VII	BCY65-VIII	BCY65-IX
$h_{FE} \geq$	—	20	40	40
typ.	20	95	190	190

$$V_{CE} = 5\text{ V}; I_C = 2\text{ mA}$$

$h_{FE} \geq$	120	180	250	250
typ.	170	250	350	350
$\leq$	220	310	460	460

$$V_{CE} = 1\text{ V}; I_C = 10\text{ mA}$$

$h_{FE} \geq$	80	120	160	160
typ.	250	300	390	390

$$V_{CE} = 1\text{ V}; I_C = 50\text{ mA}$$

$h_{FE} \leq$	—	400	630	630
$h_{FE} \geq$	40	45	60	60

		BCY65-VII	BCY65-VIII	BCY65-IX	
h-parameters					
f = 1 kHz; T <sub>amb</sub> = 25 °C;					
V <sub>CE</sub> = 5 V; I <sub>C</sub> = 2 mA					
input impedance	h <sub>ie</sub>	≥ 1,6	2,5	3,2	kΩ
	typ.	2,7	3,6	4,5	kΩ
	≤ 4,5	6,0	8,5	kΩ	
reverse voltage transfer ratio	h <sub>re</sub>	typ. 1,5·10 <sup>-4</sup>	2·10 <sup>-4</sup>	3·10 <sup>-4</sup>	
	h <sub>fe</sub>	≥ 125	175	250	
small-signal current gain	typ.	200	260	330	
	≤ 250	350	500		
	h <sub>oe</sub>	typ. 18	24	30	μs
output admittance	≤ 30	50	60	μs	

### Switching times (see Fig. 4)

I<sub>C</sub> = 10 mA; I<sub>B</sub> = -I<sub>BM</sub> = 1 mA  
 R<sub>1</sub> = R<sub>2</sub> = 5 kΩ; R<sub>L</sub> = 990 Ω; V<sub>BB</sub> = 5 V

delay time	t <sub>d</sub>	typ.	35 ns
rise time	t <sub>r</sub>	typ.	50 ns
turn-on time	t <sub>on</sub>	typ.	85 ns
		≤	150 ns
storage time	t <sub>s</sub>	typ.	400 ns
fall time	t <sub>f</sub>	typ.	80 ns
turn-off time	t <sub>off</sub>	typ.	480 ns
		≤	800 ns

I<sub>C</sub> = 50 mA; I<sub>B</sub> = -I<sub>BM</sub> = 5 mA  
 R<sub>1</sub> = 1 kΩ; R<sub>2</sub> = 1,3 kΩ; R<sub>L</sub> = 195 Ω; V<sub>BB</sub> = 4,7 V

delay time	t <sub>d</sub>	typ.	15 ns
rise time	t <sub>r</sub>	typ.	50 ns
turn-on time	t <sub>on</sub>	typ.	65 ns
		≤	150 ns
storage time	t <sub>s</sub>	typ.	300 ns
fall time	t <sub>f</sub>	typ.	150 ns
turn-off time	t <sub>off</sub>	typ.	450 ns
		≤	800 ns

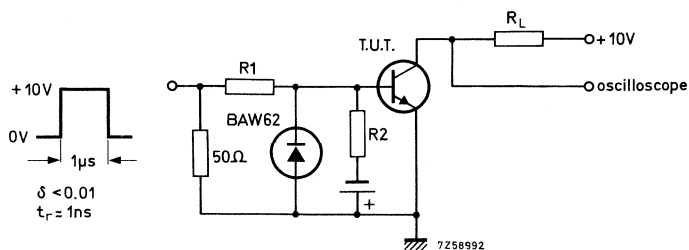

Oscilloscope:

R<sub>i</sub> > 100 kΩ  
 t<sub>r</sub> < 15 ns

Fig. 4 Test circuit.

## SILICON PLANAR EPITAXIAL TRANSISTORS



P-N-P transistors in TO-18 metal envelopes intended for general purpose industrial applications. The BCY71 is a low noise version.

## QUICK REFERENCE DATA

		BCY70	BCY71	BCY72	
Collector-base voltage (open emitter)	$-V_{CBO}$	max. 50	45	30	V
Collector-emitter voltage (open base)	$-V_{CEO}$	max. 40	45	25	V
Collector current (peak value)	$-I_{CM}$	max.	200		mA
Total power dissipation up to $T_{amb} = 25\text{ }^{\circ}\text{C}$	$P_{tot}$	max.	350		mW
Junction temperature	$T_j$	max.	200		$^{\circ}\text{C}$
D.C. current gain	$h_{FE}$	>	100		
Transition frequency at $f = 100\text{ MHz}$	$f_T$	>	250		MHz
$-I_C = 10\text{ mA}; -V_{CE} = 1\text{ V}$					
$-I_C = 10\text{ mA}; -V_{CE} = 20\text{ V}$					

## MECHANICAL DATA

Dimensions in mm

Fig. 1 TO-18.

Collector connected to case.

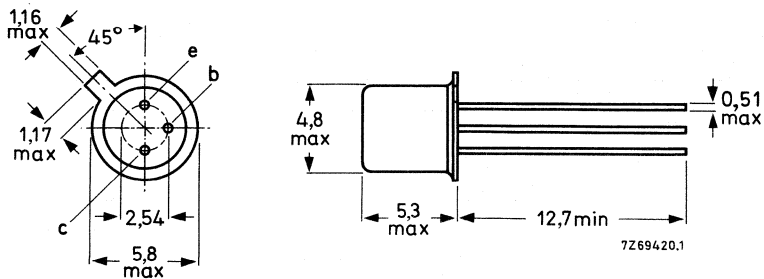

Accessories: 56246 (distance disc).

**RATINGS**

Limiting values in accordance with the Absolute Maximum System (IEC 134)

			BCY70	BCY71	BCY72	
Collector-base voltage (open emitter)	$-V_{CBO}$	max.	50	45	30	V
Collector-emitter voltage (open base)	$-V_{CEO}$	max.	40	45	25	V
Emitter-base voltage (open collector)	$-V_{EBO}$	max.	5,0	5,0	5,0	V
Collector current (d.c.)	$-I_C$	max.		200		mA
Collector current (peak value)	$-I_{CM}$	max.		200		mA
Emitter current (peak value)	$I_{EM}$	max.		200		mA
Total power dissipation up to $T_{amb} = 25\text{ }^\circ\text{C}$	$P_{tot}$	max.		350		mW
Storage temperature range	$T_{stg}$			-65 to +150		$^\circ\text{C}$
Junction temperature	$T_j$	max.		200		$^\circ\text{C}$

**THERMAL RESISTANCE**

From junction to ambient in free air	$R_{th\ j-a}$	=		500		K/W
From junction to case	$R_{th\ j-c}$	=		150		K/W

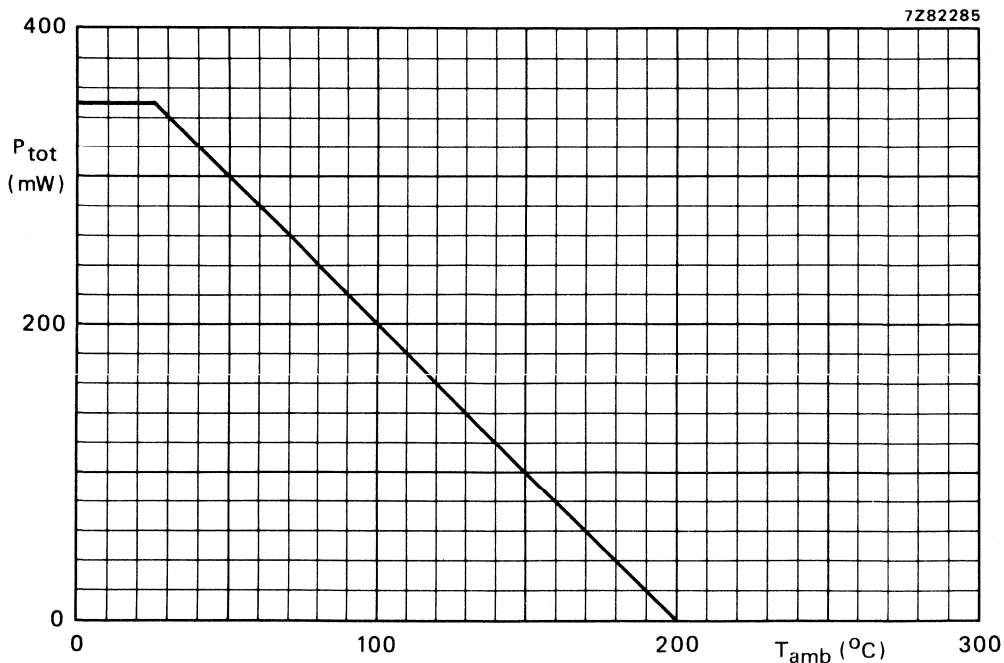

Fig. 2 Maximum permissible power dissipation as a function of ambient temperature.

## CHARACTERISTICS

 $T_j = 25\text{ }^\circ\text{C}$  unless otherwise specified

		BCY70	BCY71	BCY72	
Collector cut-off current					
$I_E = 0; -V_{CB} = -V_{CB0\max}$	$-I_{CBO}$	< 500	500	500	nA
$I_E = 0; -V_{CB} = 40\text{ V}$	$-I_{CBO}$	< 10	50	—	nA
$I_E = 0; -V_{CB} = 40\text{ V}; T_j = 100\text{ }^\circ\text{C}$	$-I_{CBO}$	< 0,5	2,0	—	$\mu\text{A}$
$I_E = 0; -V_{CB} = 25\text{ V}$	$-I_{CBO}$	< —	—	50	nA
$I_E = 0; -V_{CB} = 25\text{ V}; T_j = 100\text{ }^\circ\text{C}$	$-I_{CBO}$	< —	—	2,0	$\mu\text{A}$
$-V_{CE} = 50\text{ V}; -V_{EB} = 3,0\text{ V}$	$-I_{CEX}$	< 20	—	—	nA
Emitter cut-off current					
$I_C = 0; -V_{EB} = 4,0\text{ V}$	$-I_{EBO}$	< —	10	—	nA
$I_C = 0; -V_{EB} = 4,0\text{ V}; T_j = 100\text{ }^\circ\text{C}$	$-I_{EBO}$	< —	2,0	—	$\mu\text{A}$
$I_C = 0; -V_{EB} = 5,0\text{ V}$	$-I_{EBO}$	< —	500	—	nA
Saturation voltages					
$-I_C = 10\text{ mA}; -I_B = 10\text{ mA}$	$-V_{CE\text{sat}}$	< —	250	—	mV
	$-V_{BE\text{sat}}$	< —	600 to 900	—	mV
$-I_C = 50\text{ mA}; -I_B = 5,0\text{ mA}$	$-V_{CE\text{sat}}$	< —	500	—	mV
	$-V_{BE\text{sat}}$	< —	1200	—	mV
D.C. current gain					
$-I_C = 10\text{ }\mu\text{A}; -V_{CE} = 1,0\text{ V}$	$h_{FE}$	> —	60	—	
$-I_C = 0,1\text{ mA}; -V_{CE} = 1,0\text{ V}$	$h_{FE}$	> —	80	—	
$-I_C = 1,0\text{ mA}; -V_{CE} = 1,0\text{ V}$	$h_{FE}$	> —	100	—	
$-I_C = 10\text{ mA}; -V_{CE} = 1,0\text{ V}$	$h_{FE}$	> —	100	—	
$-I_C = 10\text{ mA}; -V_{CE} = 1,0\text{ V}$	$h_{FE}$	< —	500	—	
$-I_C = 50\text{ mA}; -V_{CE} = 1,0\text{ V}$	$h_{FE}$	> —	45	—	
Collector capacitance at $f = 1\text{ MHz}$					
$I_E = I_e = 0; -V_{CB} = 10\text{ V}$	$C_c$	< —	6,0	—	$\mu\text{F}$
Emitter capacitance at $f = 1\text{ MHz}$					
$I_C = I_c = 0; -V_{EB} = 1,0\text{ V}$	$C_e$	< —	8,0	—	$\mu\text{F}$
Transition frequency at $T_{\text{amb}} = 25\text{ }^\circ\text{C}$					
$-I_C = 10\text{ mA}; -V_{CE} = 20\text{ V}; f = 100\text{ MHz}$	$f_T$	> 250	250	250	MHz
$-I_C = 100\text{ }\mu\text{A}; -V_{CE} = 20\text{ V}; f = 10,7\text{ MHz}$	$f_T$	> —	15	—	MHz
Noise figure					
$-I_C = 100\text{ }\mu\text{A}; -V_{CE} = 5,0\text{ V}$ $f = 10\text{ Hz to }10\text{ kHz}; R_S = 2,0\text{ k}\Omega$	F	< 6,0	2,0	6,0	dB
h-parameters (common emitter)					
$-I_C = 10\text{ mA}; -V_{CE} = 10\text{ V}; f = 1\text{ kHz};$ $T_{\text{amb}} = 25\text{ }^\circ\text{C}$					
Input impedance	$h_{ie}$	typ. —	4,0	—	$\text{k}\Omega$
Reverse voltage transfer ratio	$h_{re}$	typ. —	2,1	—	$10^{-4}$
Small-signal current gain	$h_{fe}$	typ. —	325	—	
Output admittance	$h_{oe}$	typ. —	20	—	$\mu\text{S}$

Switching times of the BCY70 and BCY72

$-I_C = 10 \text{ mA}$ ;  $-I_{B\text{on}} = +I_{B\text{off}} = 1 \text{ mA}$

delay time

rise time

turn-on time

storage time

fall time

turn-off time

$t_d$	<	35 ns
$t_r$	<	35 ns
$t_{\text{on}}$	<	65 ns
$t_s$	<	420 ns
$t_f$	<	80 ns
$t_{\text{off}}$	<	500 ns

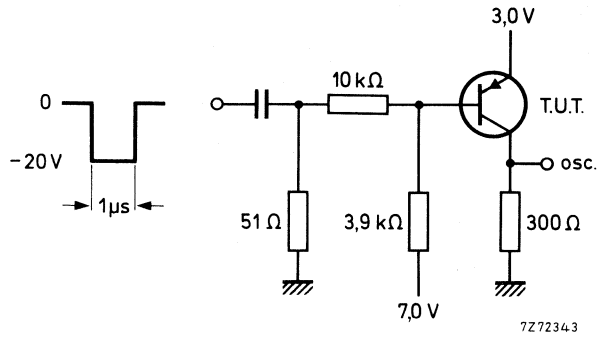

Fig. 3 Test circuit.

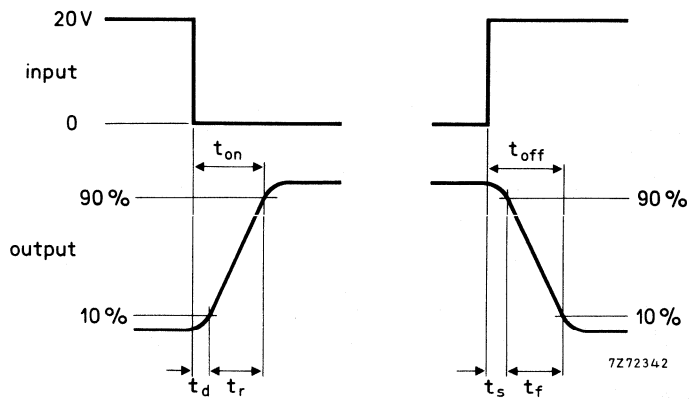

Fig. 4 Switching waveforms.



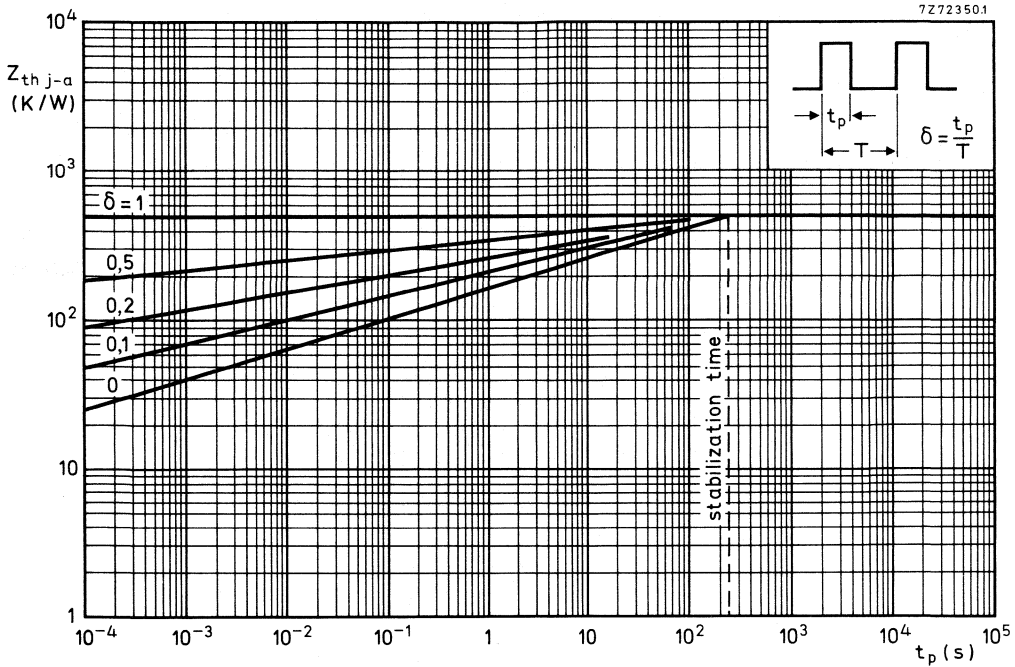

Fig. 5.

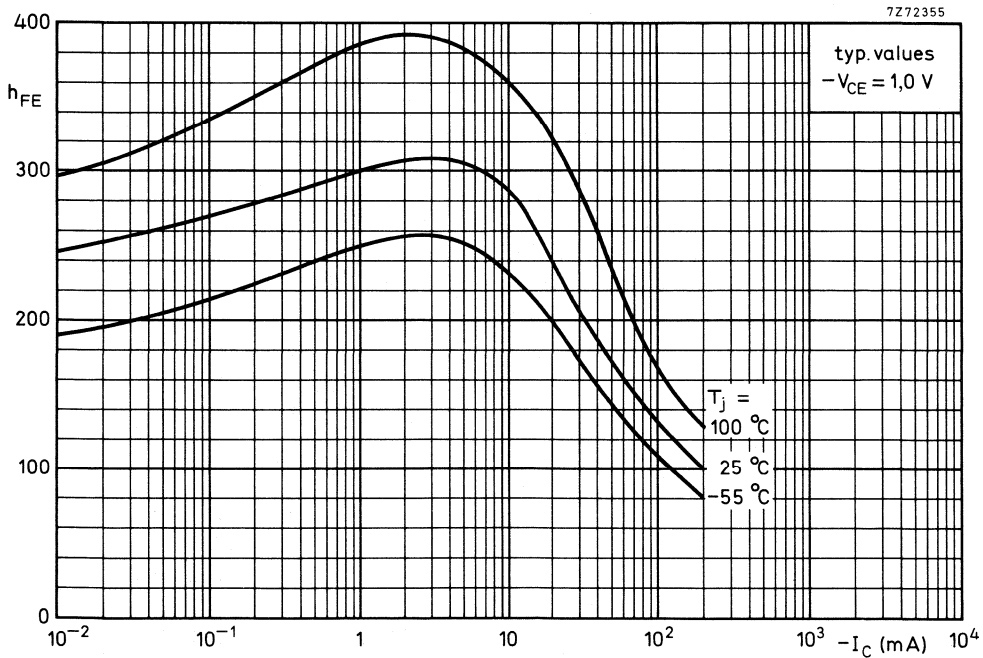

Fig. 6.

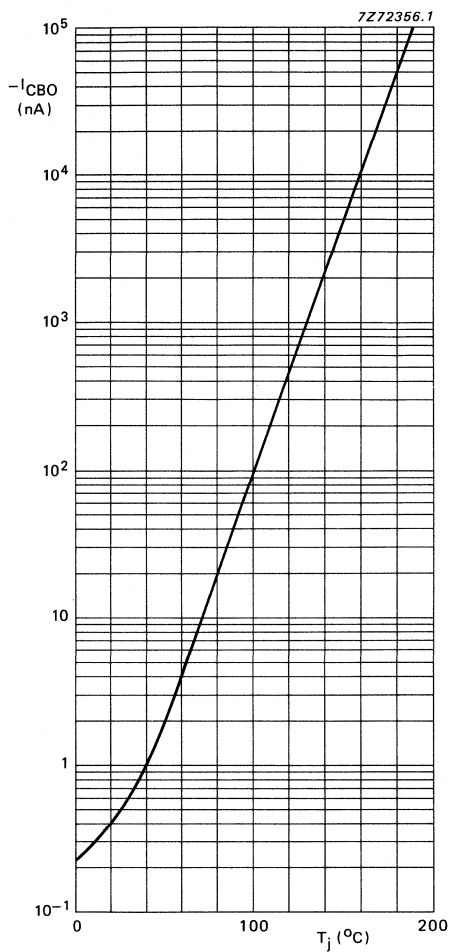

Fig. 7  $-V_{CB} = 40$  V for BCY70 and BCY71;  
 $-V_{CB} = 25$  V for BCY72; typical values.

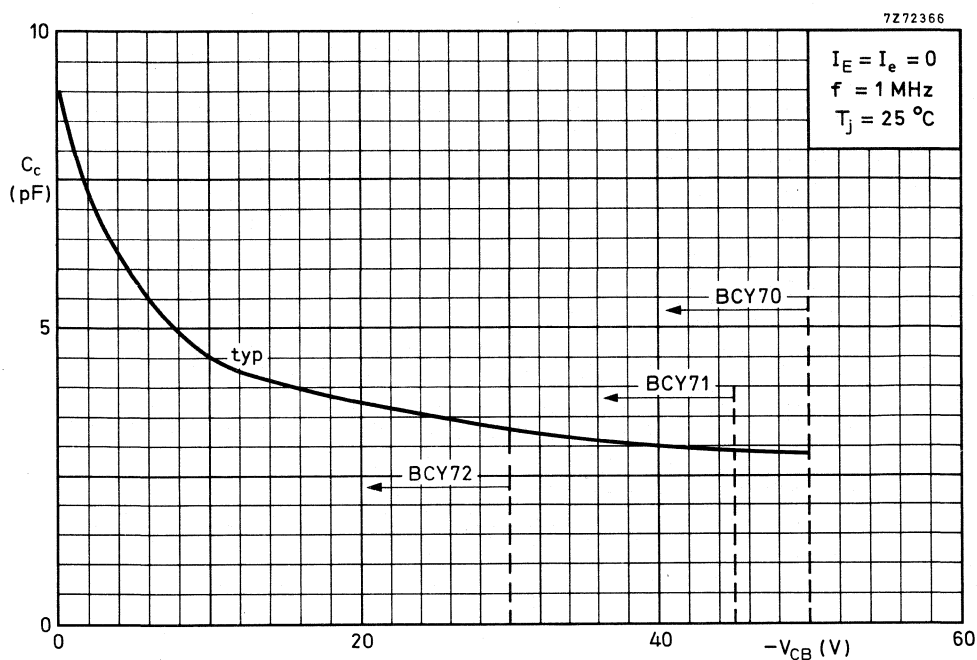

Fig. 8.

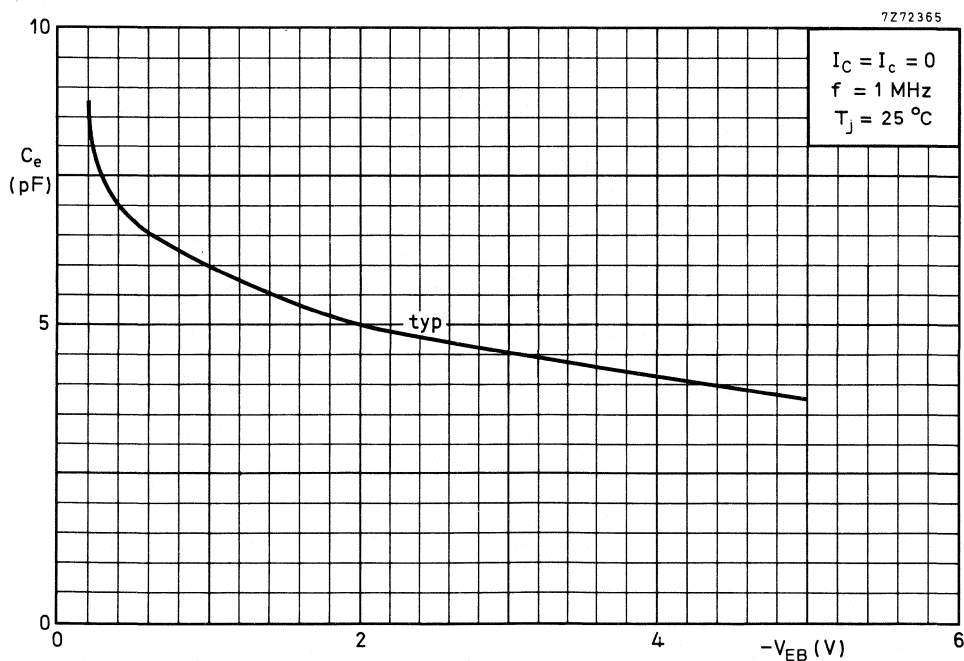

Fig. 9.

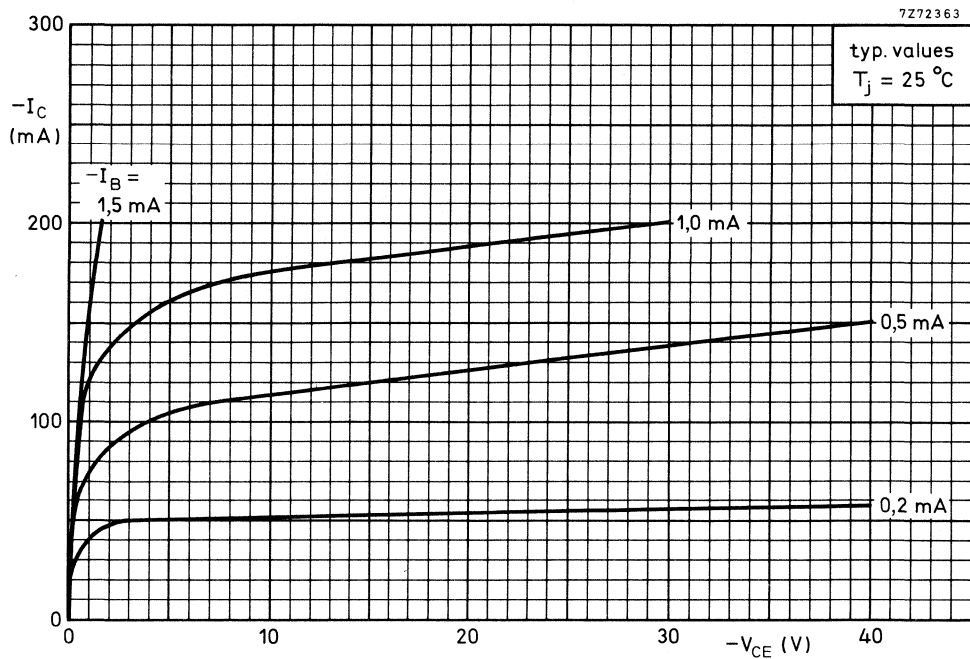

Fig. 10.

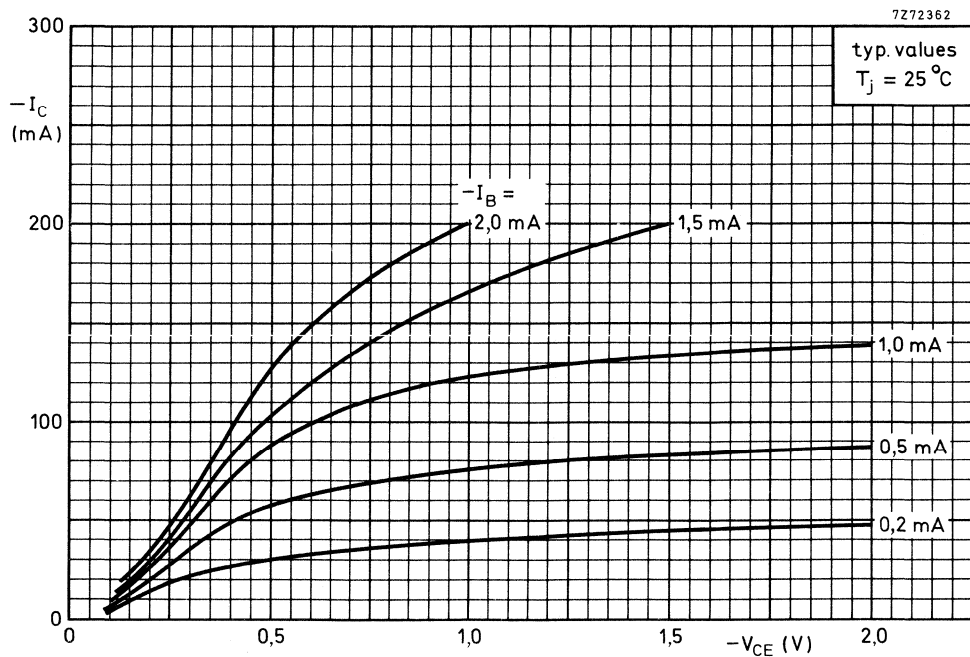

Fig. 11.

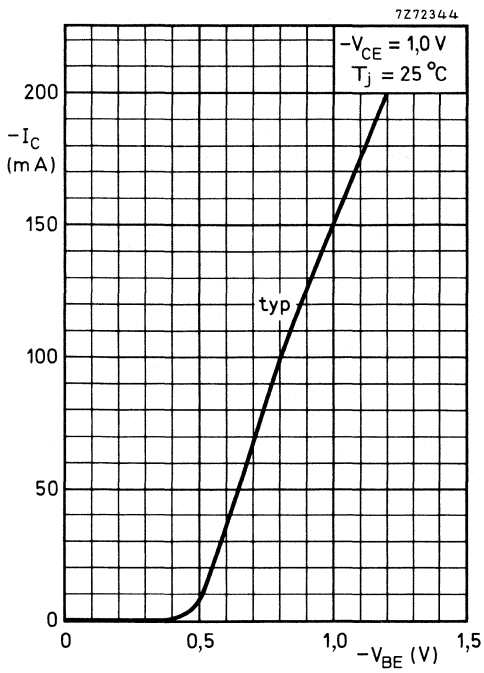

Fig. 12.

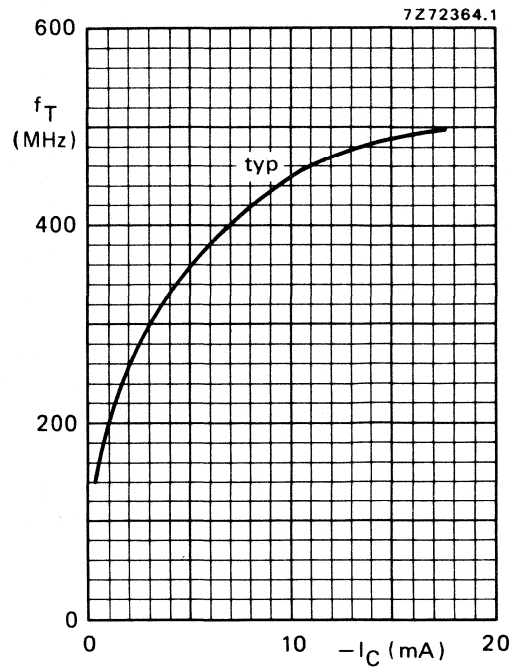

Fig. 13  $-V_{CE} = 20 \text{ V}$ ;  $f = 100 \text{ MHz}$ ;  $T_{amb} = 25 \text{ }^\circ\text{C}$ .

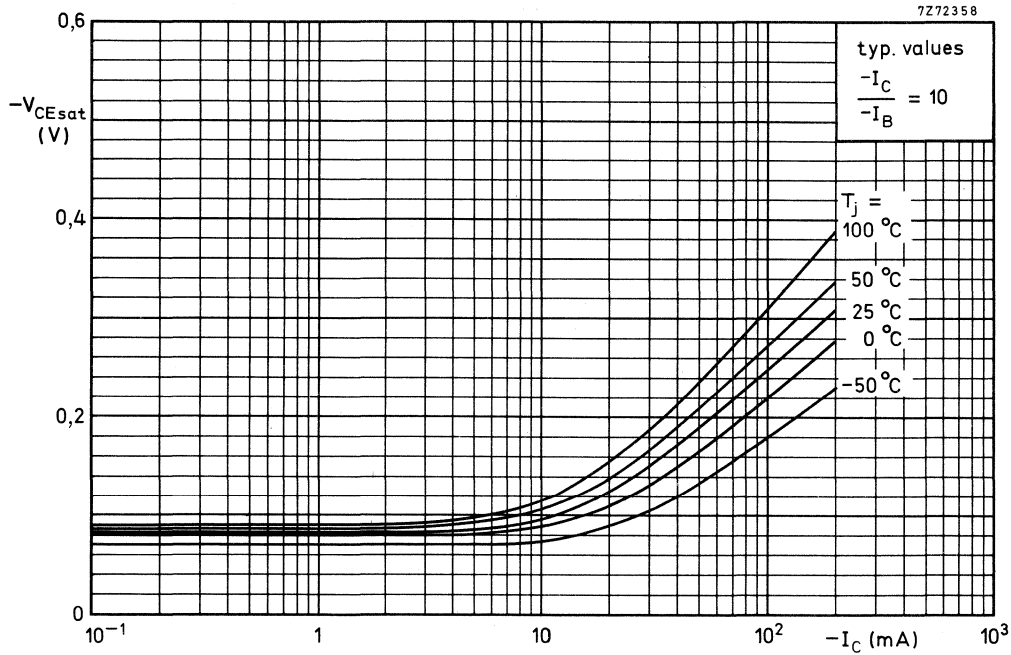

Fig. 14.

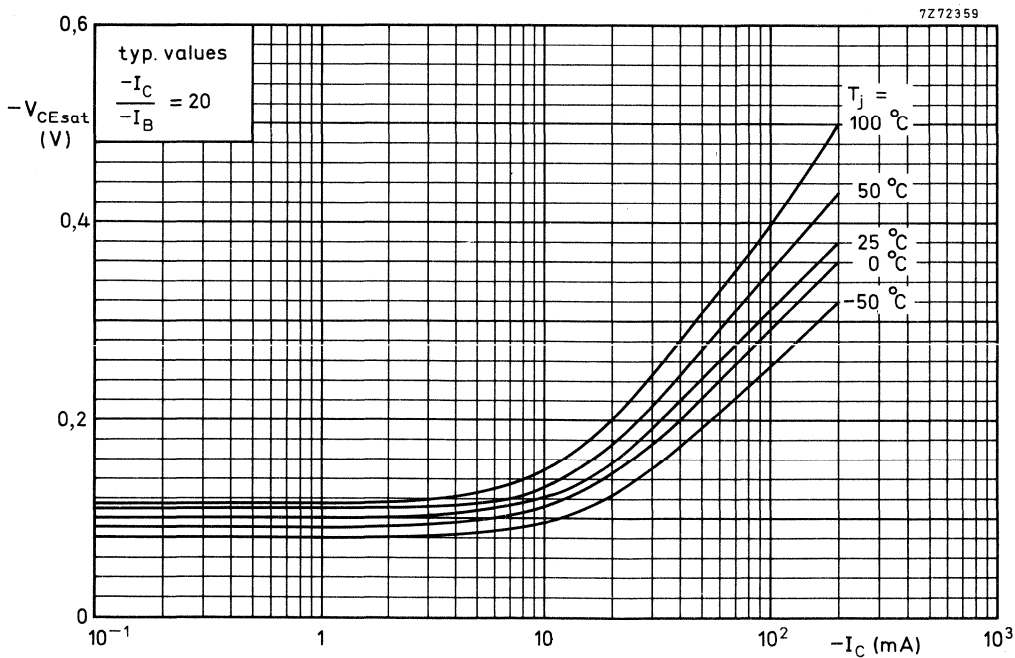

Fig. 15.

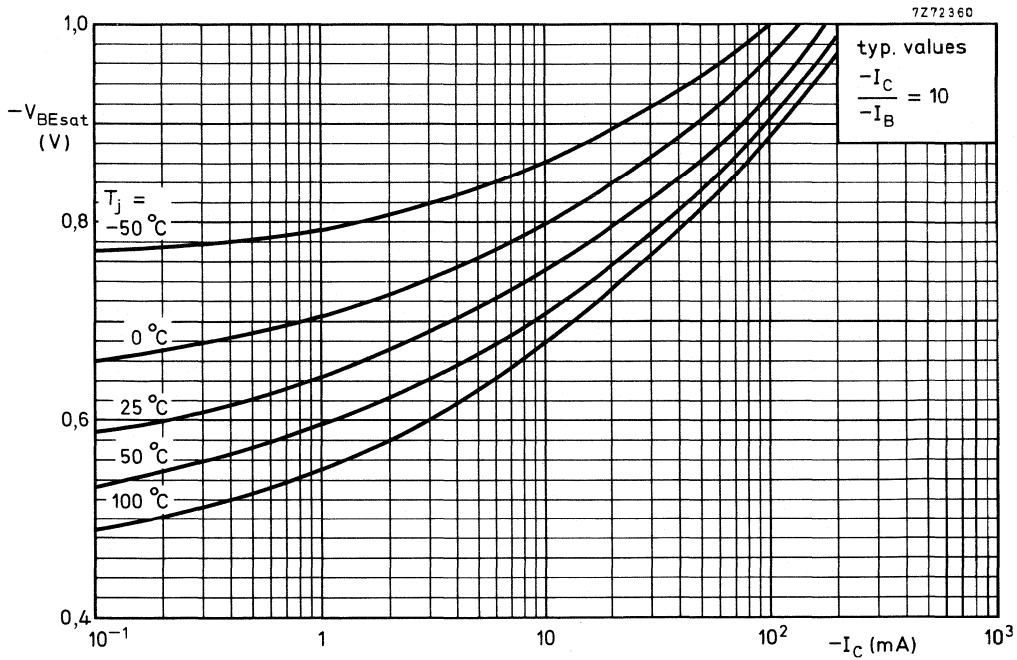

Fig. 16.

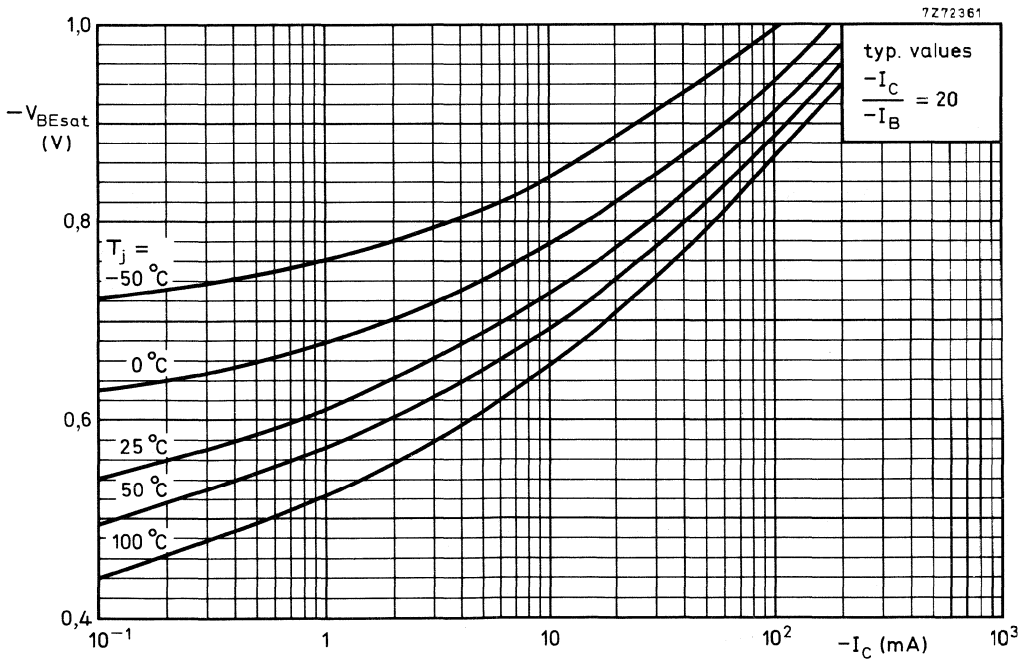

Fig. 17.

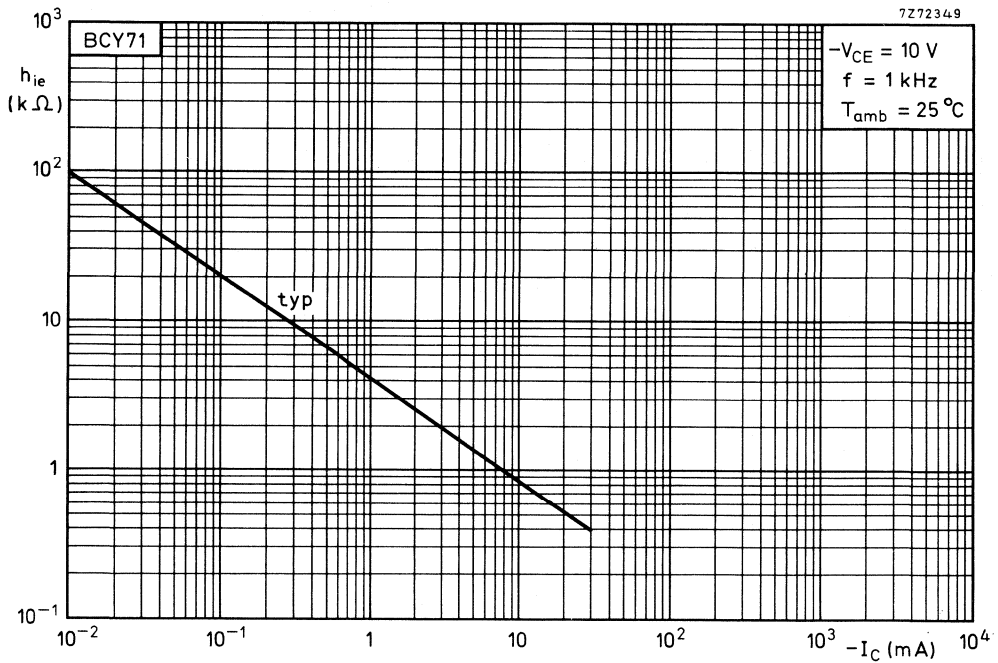

Fig. 18.

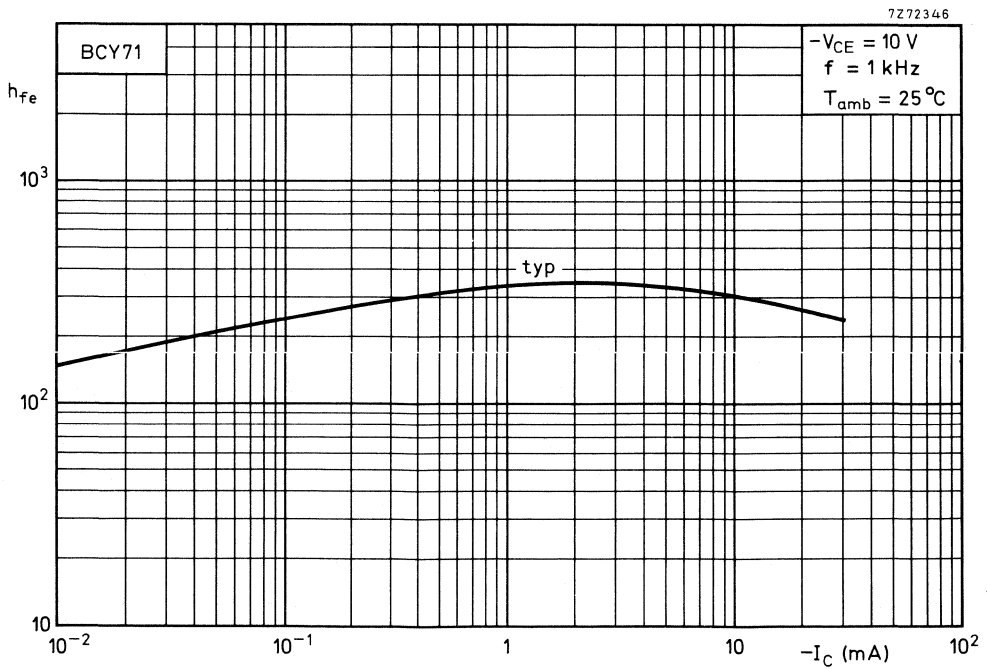

Fig. 19.



7Z72347

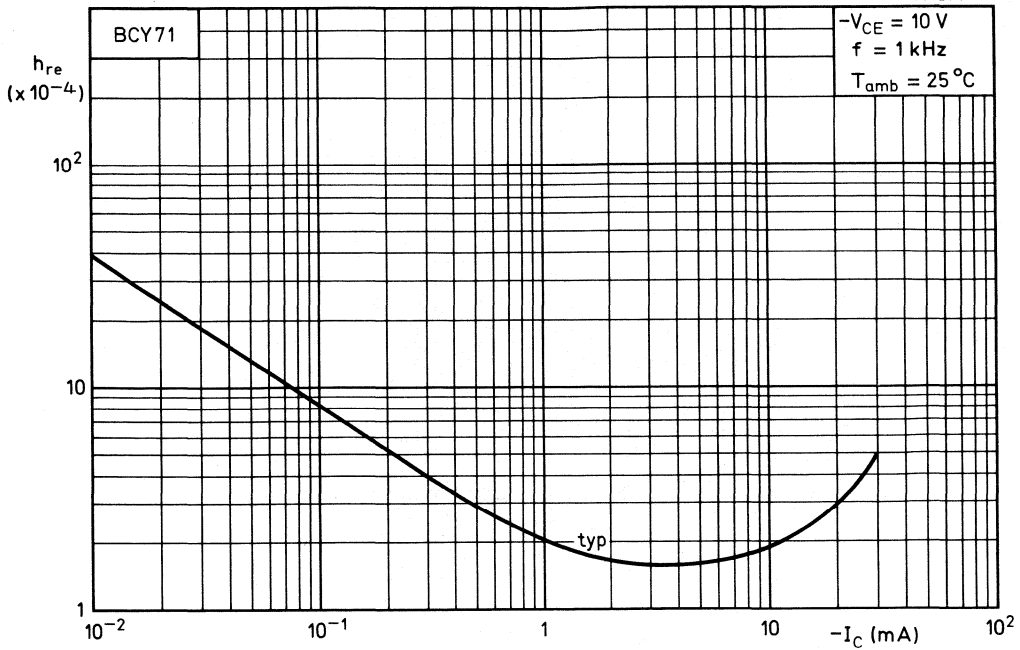

Fig. 20.

7Z72348

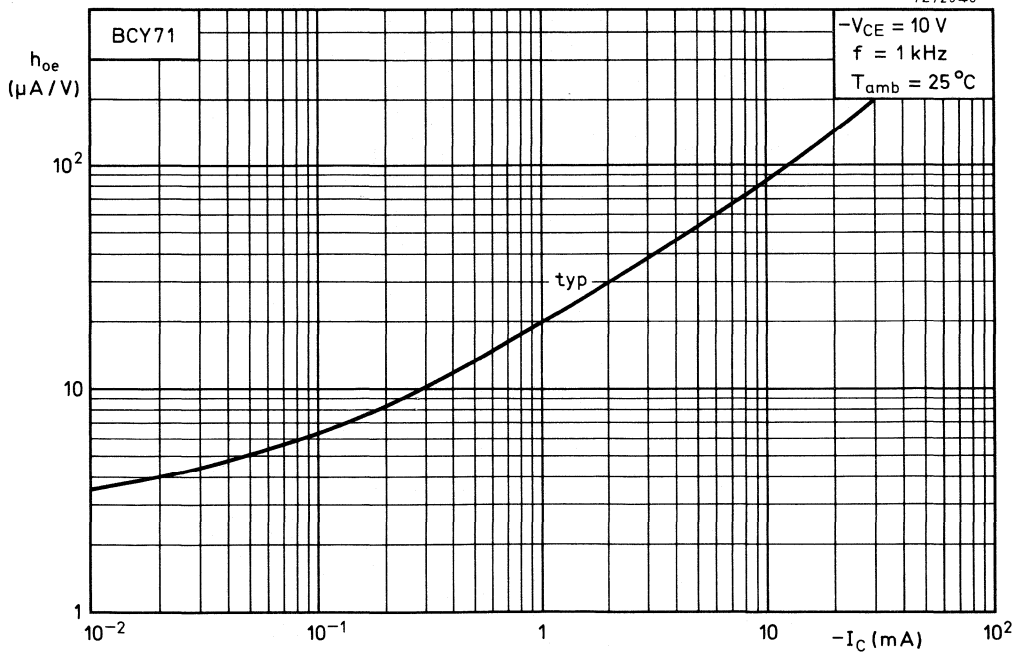

Fig. 21.

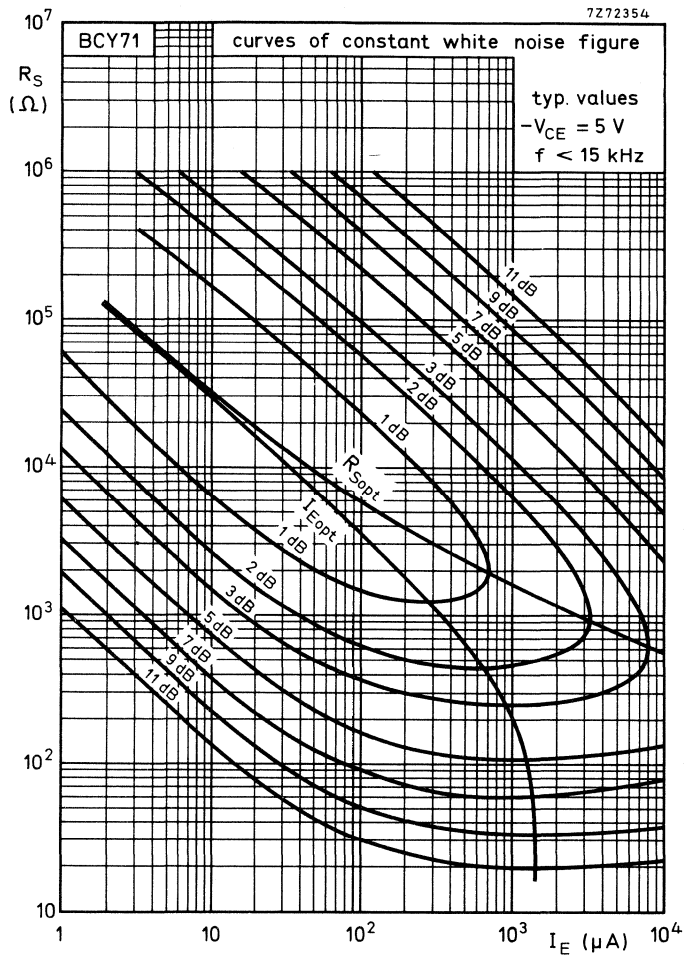

Fig. 22.

See also the graph and text on next page.

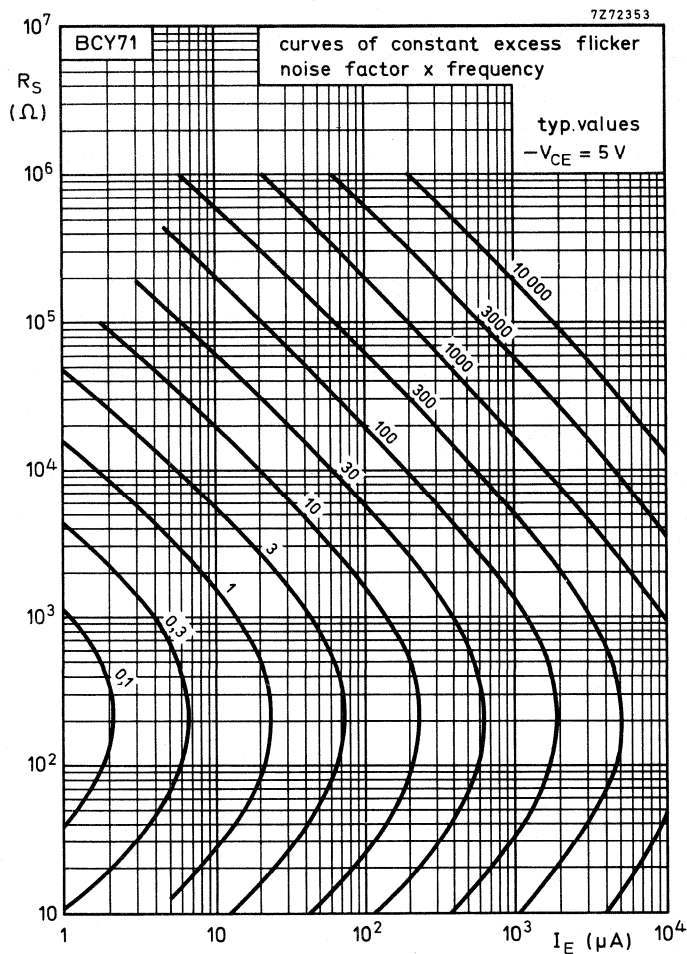

Fig. 23.

#### Determination of total noise figure

Total noise at  $f < 15\text{ kHz}$  includes flicker noise and white noise.

The relationship is as follows: noise factor = 1 + flicker noise factor + white noise factor.

The flicker noise factor can be derived from the curves of the graph above, the white noise factor from the curves of the graph on preceding page.

Example:

Assume a BCY71 operating at  $f = 200\text{ Hz}$ ;  $I_E = 200\ \mu\text{A}$  with a source resistance  $R_S = 10\text{ k}\Omega$ . From the graph on this page it follows that at  $I_E = 200\ \mu\text{A}$  with  $R_S = 10\text{ k}\Omega$  the product of frequency and flicker noise factor is 110. Since the frequency is 200 Hz, the flicker noise factor is  $110/200 = 0,55$ . It follows that at  $I_E = 200\ \mu\text{A}$  with  $R_S = 10\text{ k}\Omega$  the white noise figure is 0,9 dB, representing a factor of 1,23. Thus the total noise factor =  $0,55 + 1,23 = 1,78$  or 2,5 dB.

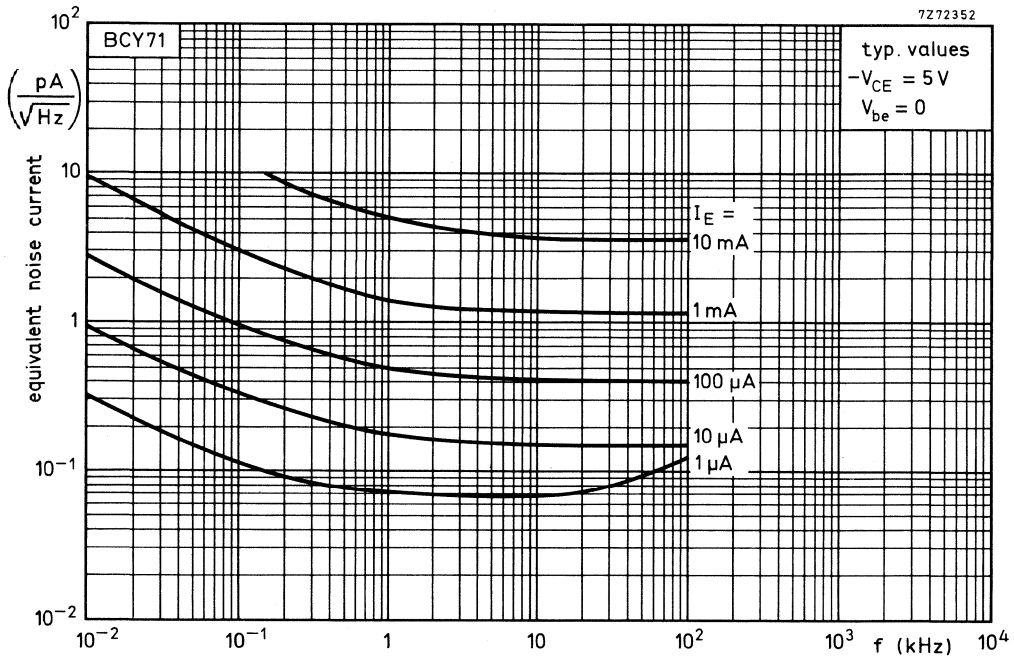

Fig. 24.

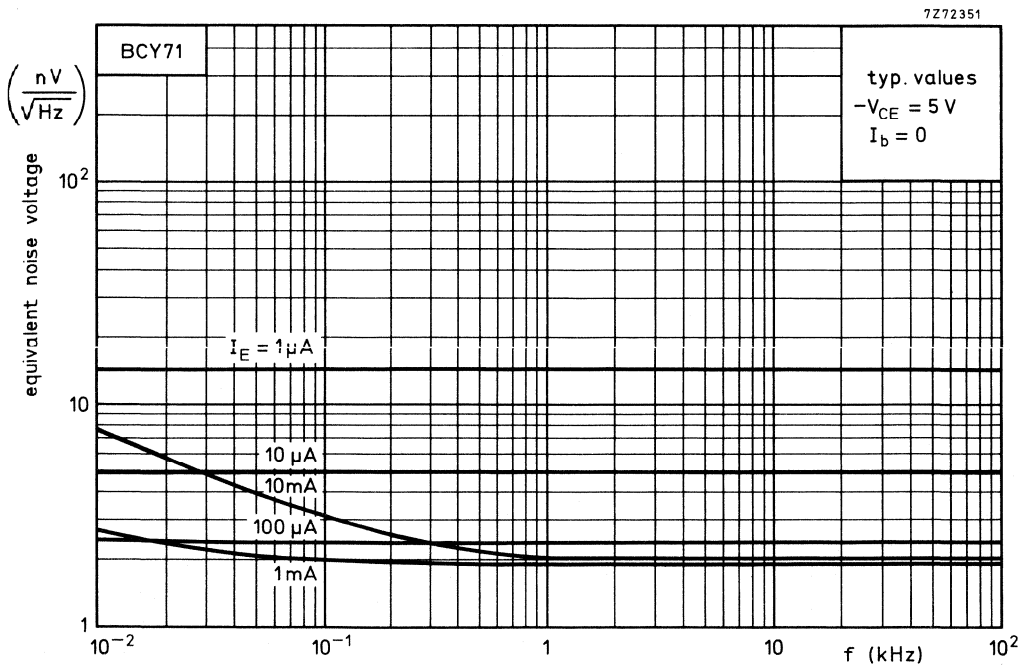

Fig. 25.

SILICON PLANAR EPITAXIAL TRANSISTORS



P-N-P transistors in TO-18 metal envelopes, intended for use in amplifier and switching applications.

QUICK REFERENCE DATA

		BCY78	BCY79			
Collector-emitter voltage (open base)	$-V_{CE0}$ max.	32	45	V		
Collector current (d.c.)	$-I_C$ max.	200		mA		
Total power dissipation up to $T_{amb} = 45\text{ }^\circ\text{C}$ up to $T_{case} = 45\text{ }^\circ\text{C}$	$P_{tot}$ max.	345		mW		
	$P_{tot}$ max.	1000		mW		
Junction temperature	$T_j$ max.	200		$^\circ\text{C}$		
		BCY78-VII BCY79-VII	VIII VIII	IX IX	X	
Small-signal current gain $-I_C = 2\text{ mA}; -V_{CE} = 5\text{ V}$	$h_{fe}$	>	125	175	250	350
		<	250	350	500	700
Transition frequency at $f = 35\text{ MHz}$ $-I_C = 10\text{ mA}; -V_{CE} = 5\text{ V}$	$f_T$ typ.	180			MHz	
Noise figure at $R_S = 2\text{ k}\Omega$ $-I_C = 200\text{ }\mu\text{A}; -V_{CE} = 5\text{ V}$ $f = 1\text{ kHz}; B = 200\text{ Hz}$	F typ.	2			dB	

MECHANICAL DATA

Dimensions in mm

Fig. 1 TO-18.

Collector connected to case

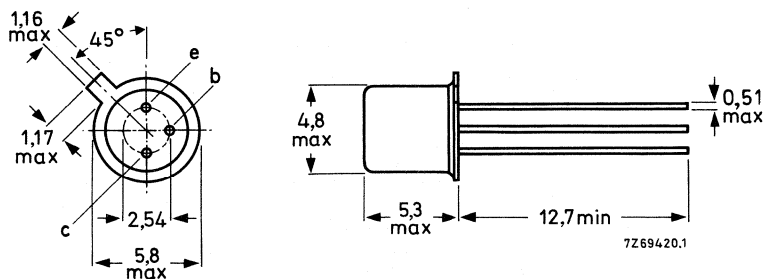

Accessories: 56246 (distance disc).

**RATINGS**

Limiting values in accordance with the Absolute Maximum System (IEC 134)

			<b>BCY78</b>	<b>BCY79</b>
Collector-emitter voltage ( $V_{BE} = 0$ )	$-V_{CES}$	max.	32	45 V
Collector-emitter voltage (open base)	$-V_{CEO}$	max.	32	45 V
Emitter-base voltage (open collector)	$-V_{EBO}$	max.	5	5 V
Collector current (d.c.)	$-I_C$	max.	200	mA
Base current (d.c.)	$-I_B$	max.	20	mA
Total power dissipation up to $T_{amb} = 45\text{ }^\circ\text{C}$	$P_{tot}$	max.	345	mW
up to $T_{case} = 45\text{ }^\circ\text{C}$	$P_{tot}$	max.	1000	mW
Storage temperature range	$T_{stg}$		-65 to 150	$^\circ\text{C}$
Junction temperature	$T_j$	max.	200	$^\circ\text{C}$

**THERMAL RESISTANCE**

From junction to ambient in free air	$R_{th\ j-a}$	=	0,45	K/mW
From junction to case	$R_{th\ j-c}$	=	0,15	K/mW

## CHARACTERISTICS

 $T_{amb} = 25\text{ }^{\circ}\text{C}$  unless otherwise specified

		BCY78	BCY79
Collector cut-off currents $V_{BE} = 0; -V_{CE} = 25\text{ V}$	$-I_{CES}$	typ. 2 < 20	– nA – nA
	$-I_{CES}$	typ. – < –	2 nA 20 nA
$V_{BE} = 0; -V_{CE} = 35\text{ V}$	$-I_{CES}$	< 10	– $\mu\text{A}$
	$-I_{CES}$	< –	10 $\mu\text{A}$
$V_{BE} = 0; -V_{CE} = 25\text{ V}; T_{amb} = 150\text{ }^{\circ}\text{C}$ $V_{BE} = 0; -V_{CE} = 35\text{ V}; T_{amb} = 150\text{ }^{\circ}\text{C}$	$-I_{CES}$	< 100	100 nA
	$-I_{CES}$	< 100	100 nA
$V_{BE} = 0; -V_{CE} = -V_{CEO\text{ max}}$ $-V_{EB} = 0,2\text{ V}; -V_{CE} = -V_{CEO\text{ max}};$ $T_{amb} = 100\text{ }^{\circ}\text{C}$	$-I_{CES}$	< 20	20 $\mu\text{A}$
	$-I_{CEX}$	< 20	20 $\mu\text{A}$
Emitter cut-off current $I_C = 0; -V_{EB} = 4\text{ V}$	$-I_{EBO}$	< 20	20 nA
	$-I_{EBO}$	< 20	20 nA
Collector-emitter breakdown voltage $V_{BE} = 0; -I_C = 10\text{ }\mu\text{A}$ $I_B = 0; -I_C = 2\text{ mA}$	$-V_{(BR)CES}$	> 32	45 V
	$-V_{(BR)CEO}$	> 32	45 V
Emitter-base breakdown voltage $I_C = 0; -I_E = 1\text{ }\mu\text{A}$	$-V_{(BR)EBO}$	> 5	V
	$-V_{(BR)EBO}$	> 5	V
Base-emitter voltage $-I_C = 10\text{ }\mu\text{A}; -V_{CE} = 5\text{ V}$ $-I_C = 2\text{ mA}; -V_{CE} = 5\text{ V}$	$-V_{BE}$	typ. 550 600 to 750	mV mV mV
	$-V_{BE}$	typ. 650 600 to 750	mV mV
$-I_C = 10\text{ mA}; -V_{CE} = 1\text{ V}$ $-I_C = 100\text{ mA}; -V_{CE} = 1\text{ V}$	$-V_{BE}$	typ. 680	mV
	$-V_{BE}$	typ. 750	mV
Saturation voltages $-I_C = 10\text{ mA}; -I_B = 250\text{ }\mu\text{A}$ $-I_C = 100\text{ mA}; -I_B = 2,5\text{ mA}$	$-V_{CEsat}$	typ. 120 < 250	mV mV
	$-V_{CEsat}$	typ. 700 600 to 850	mV mV
$-I_C = 100\text{ mA}; -I_B = 2,5\text{ mA}$	$-V_{CEsat}$	typ. 400 < 800	mV mV
	$-V_{CEsat}$	typ. 850 700 to 1200	mV mV
Transition frequency at $f = 35\text{ MHz}$ $-I_C = 10\text{ mA}; -V_{CE} = 5\text{ V}$	$f_T$	typ. 180	MHz
	$f_T$	typ. 180	MHz

**BCY78**  
**BCY79**

Collector capacitance at  $f = 1 \text{ MHz}$

$I_E = I_e = 0; -V_{CB} = 10 \text{ V}$

$C_c < 7,0 \text{ pF}$

Emitter capacitance at  $f = 1 \text{ MHz}$

$I_C = I_c = 0; -V_{EB} = 0,5 \text{ V}$

$C_e < 15 \text{ pF}$

Noise figure at  $R_S = 2 \text{ k}\Omega$

$-I_C = 200 \mu\text{A}; -V_{CE} = 5 \text{ V}$   
 $f = 1 \text{ kHz}; B = 200 \text{ Hz}$

$F \begin{matrix} \text{typ.} \\ < \end{matrix} \begin{matrix} 2 \\ 6 \end{matrix} \text{ dB}$

D.C. current gain

$-I_C = 10 \mu\text{A}; -V_{CE} = 5 \text{ V}$

		<b>BCY78-VII</b>	<b>VIII</b>	<b>IX</b>	<b>X</b>
		<b>BCY79-VII</b>	<b>VIII</b>	<b>IX</b>	
$h_{FE}$	$>$	—	30	40	100
	typ.	140	200	270	340
$h_{FE}$	$>$	120	180	250	380
	typ.	170	250	350	500
	$<$	220	310	460	630
$h_{FE}$	$>$	80	120	160	240
	typ.	180	260	360	500
	$<$	—	400	630	1000
$h_{FE}$	$>$	40	45	60	60
$h_{ie}$	typ.	2,7	3,6	4,5	7,5 $\text{k}\Omega$
$h_{re}$	typ.	1,5	2	2	3 $10^{-4}$
$h_{fe}$	typ.	200	260	330	520
$h_{oe}$	typ.	18	24	30	50 $\mu\text{S}$

$-I_C = 2 \text{ mA}; -V_{CE} = 5 \text{ V}$

$-I_C = 10 \text{ mA}; -V_{CE} = 1 \text{ V}$

$-I_C = 100 \text{ mA}; -V_{CE} = 1 \text{ V}$

h-parameters at  $f = 1 \text{ kHz}$

$-I_C = 2 \text{ mA}; -V_{CE} = 5 \text{ V}$

Input impedance

Reverse voltage transfer ratio

Small-signal current gain

Output admittance



Switching times

$-I_{C\text{ on}} = 10\text{ mA}; -I_{B\text{ on}} = I_{B\text{ off}} = 1\text{ mA}$   
 $R_1 = R_2 = 5\text{ k}\Omega; R_L = 990\ \Omega$   
 $V_B = 3,6\text{ V}$

delay time	$t_d$	typ.	35 ns
rise time	$t_r$	typ.	50 ns
turn-on time ( $t_d + t_r$ )	$t_{on}$	typ.	85 ns
		<	150 ns
storage time	$t_s$	typ.	400 ns
fall time	$t_f$	typ.	80 ns
turn-off time ( $t_s + t_f$ )	$t_{off}$	typ.	480 ns
		<	800 ns

$-I_{C\text{ on}} = 100\text{ mA}; -I_{B\text{ on}} = I_{B\text{ off}} = 10\text{ mA}$   
 $R_1 = 500\ \Omega; R_2 = 700\ \Omega; R_L = 98\ \Omega$   
 $V_B = 5\text{ V}$

delay time	$t_d$	typ.	5 ns
rise time	$t_r$	typ.	50 ns
turn-on time ( $t_d + t_r$ )	$t_{on}$	typ.	55 ns
		<	150 ns
storage time	$t_s$	typ.	250 ns
fall time	$t_f$	typ.	200 ns
turn-off time ( $t_s + t_f$ )	$t_{off}$	typ.	450 ns
		<	800 ns

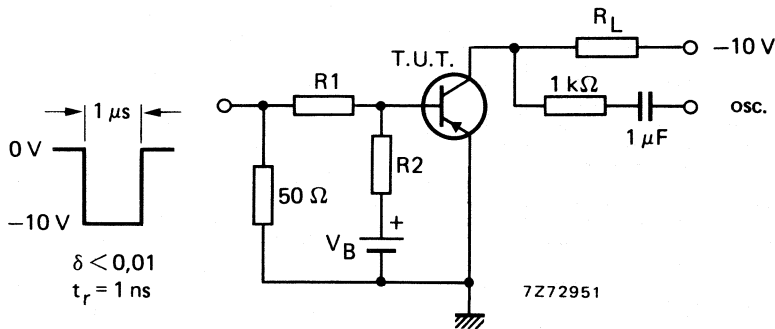

Fig. 2 Test circuit.

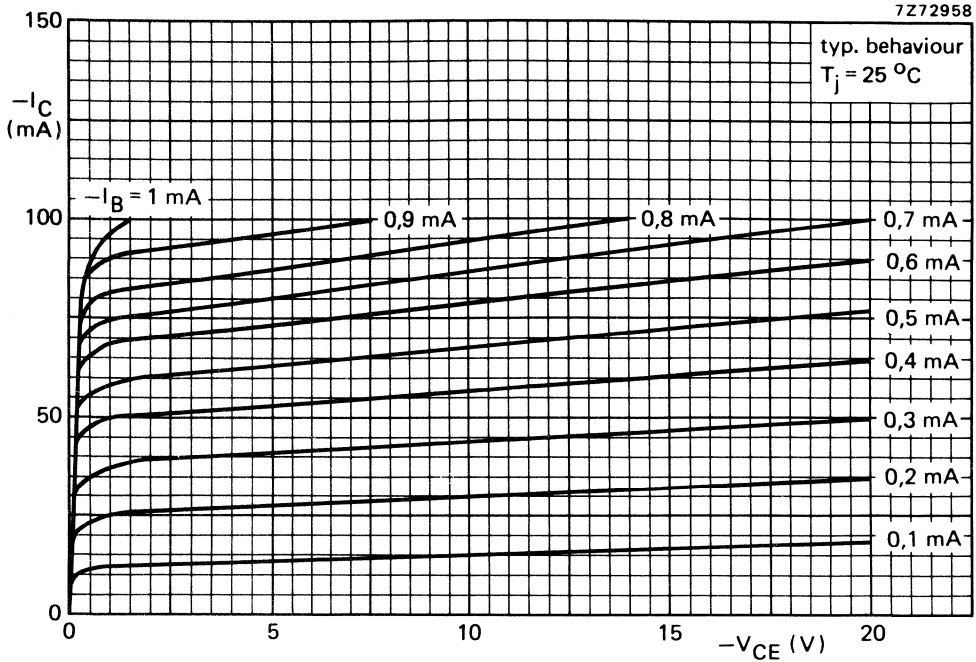

Fig. 3.

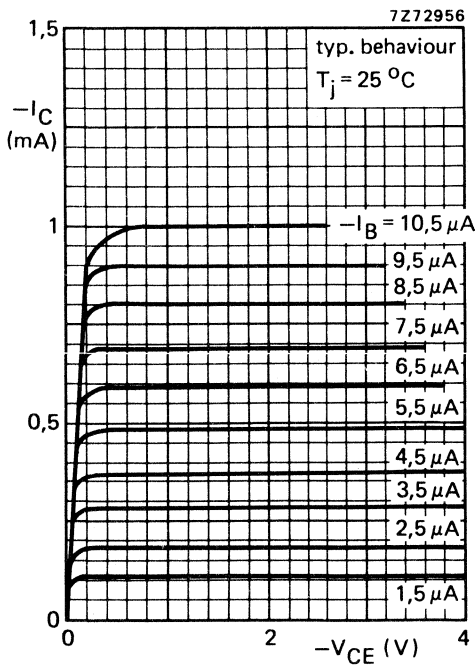

Fig. 4.

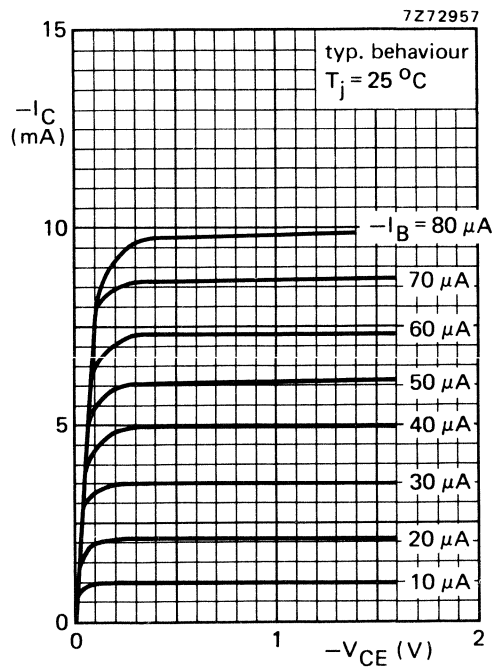

Fig. 5.

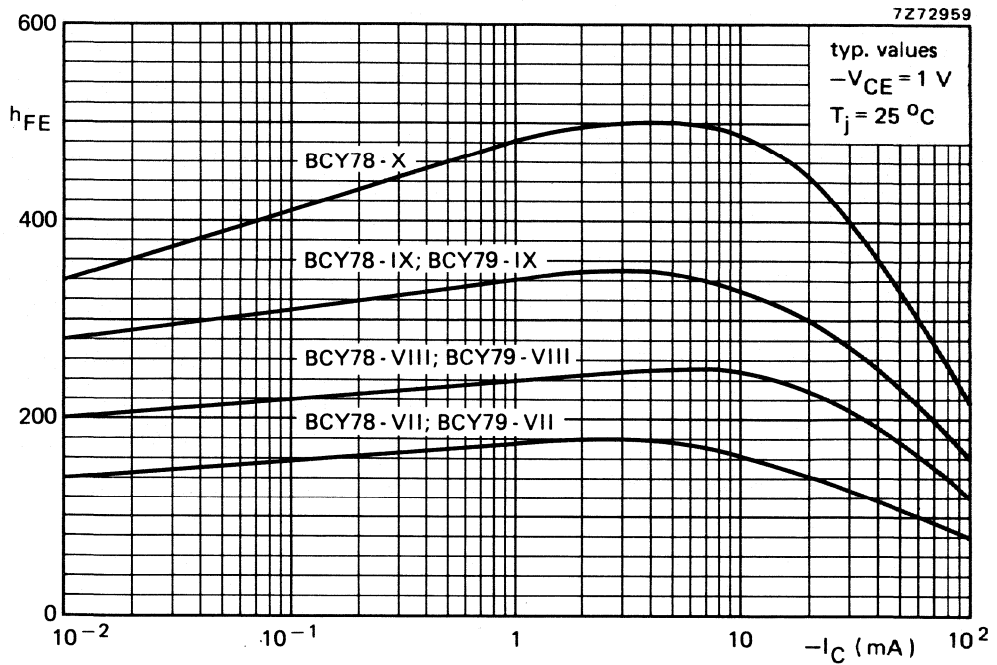

Fig. 6.

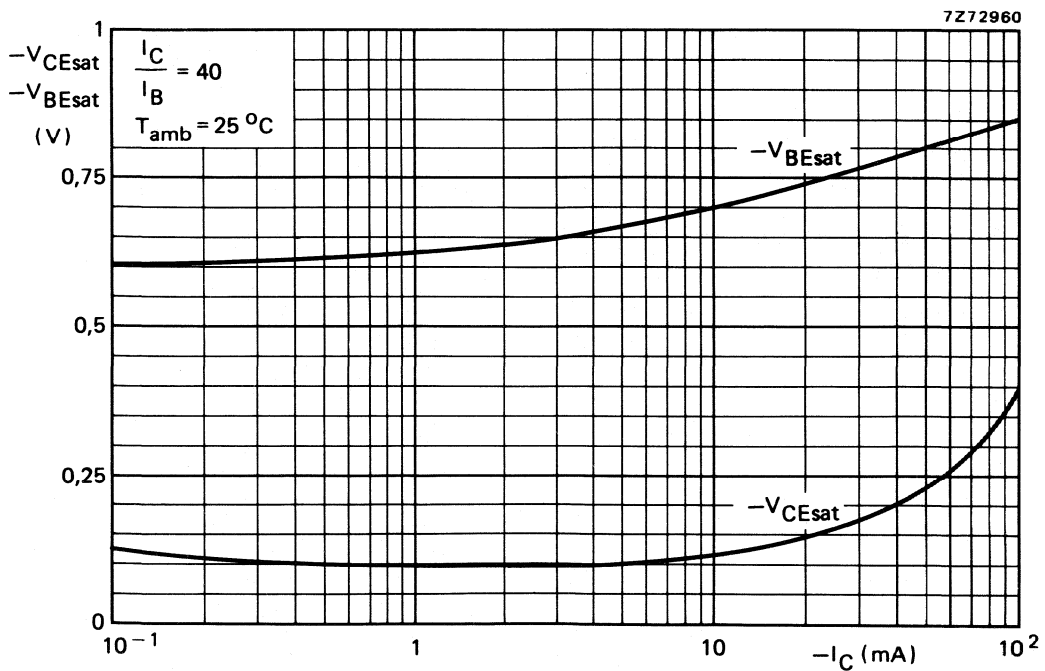

Fig. 7.

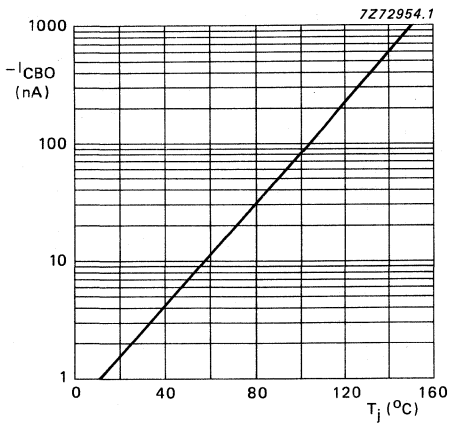

Fig. 8  $-V_{CB} = 25\text{ V}$  for BCY78;  
 $-V_{CB} = 35\text{ V}$  for BCY79;  
typical values.

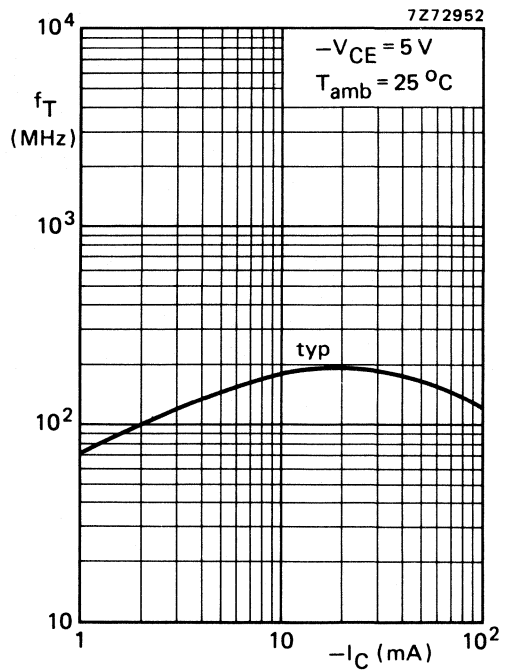

Fig. 9.

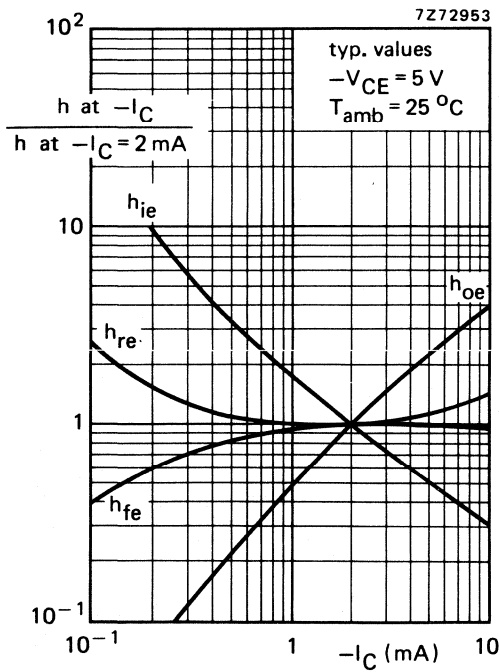

Fig. 10.

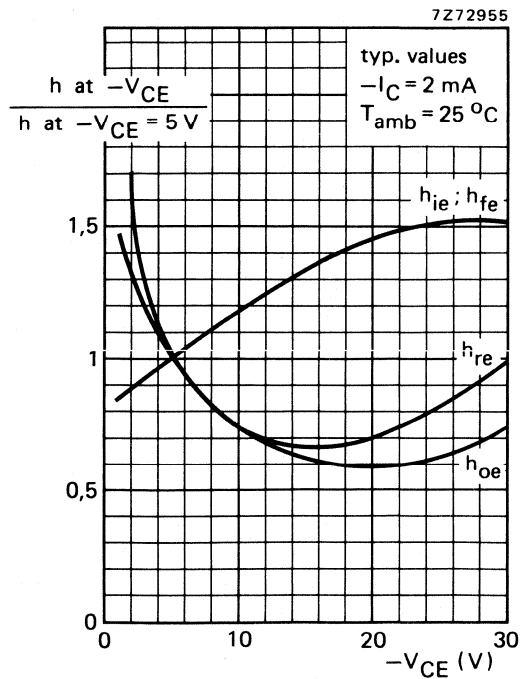

Fig. 11.

## N-P-N SILICON PLANAR DUAL TRANSISTORS FOR DIFFERENTIAL AMPLIFIERS

Matched dual n-p-n transistors in a TO-71 metal envelope with all leads insulated from the case. They are primarily intended for differential amplifier applications in general industrial service; e.g. instrumentation and control.

Products are divided into three types according to their matching accuracy.

The BCY87 and BCY88 are intended for applications in pre-stages of differential amplifiers where low offset, drift and noise are of prime importance. The BCY89 is for second stages, long-tailed pairs and more general purposes.

### QUICK REFERENCE DATA

#### Ratings

Collector-base voltage (open emitter)	$V_{CBO}$	max	45 V
Collector-emitter voltage (open base)	$V_{CEO}$	max	40 V
Total power dissipation up to $T_{amb} = 25\text{ }^{\circ}\text{C}$	$P_{tot}$	max	150 mW
Junction temperature	$T_j$	max	175 $^{\circ}\text{C}$

**Characteristics** of the complete device with collector-base voltage of 10 V and sum of emitter currents from 10 to 100  $\mu\text{A}$ .

	BCY87	BCY88	BCY89	
Ratio of collector currents at $V_{1B-1E} = V_{2B-2E}$	$I_{1C}/I_{2C}$	0,9–1,11	0,8–1,25	0,67–1,5
Base current difference at $V_{1B-1E} = V_{2B-2E}$	$ I_{1B}-I_{2B} $	< 25	80	300 nA
Equivalent differential voltage change with temperature *	$ \frac{\Delta V}{\Delta T} $	< 3	6	10 $\mu\text{V/K}$
Equivalent differential current change with temperature *	$ \frac{\Delta I}{\Delta T} $	< 0,5	2	10 nA/K

### MECHANICAL DATA

Dimensions in mm

Fig. 1 TO-71.

All leads insulated from the case

Accessories:  
56263 (cooling fin).

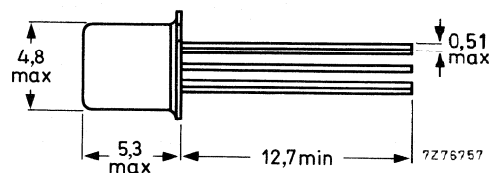
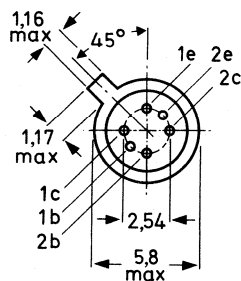

\*  $T_{amb} = -20\text{ }^{\circ}\text{C}$  to  $+90\text{ }^{\circ}\text{C}$ .

**RATINGS** (see after Fig. 9)

**CHARACTERISTICS** of the individual transistors

$T_{amb} = 25\text{ }^{\circ}\text{C}$  unless otherwise specified

		BCY87	BCY88	BCY89
<b>Collector cut-off currents</b>				
$I_E = 0; V_{CB} = 20\text{ V}; T_{amb} = 90\text{ }^{\circ}\text{C}$	$I_{CBO}$	< 5	20	— nA
$I_E = 0; V_{CB} = 20\text{ V}$	$I_{CBO}$	< —	—	10 nA
<b>D.C. current gain</b>				
$I_C = 5\text{ }\mu\text{A}; V_{CB} = 10\text{ V}$	$h_{FE}$	> 80	—	—
$I_C = 50\text{ }\mu\text{A}; V_{CB} = 10\text{ V}$	$h_{FE}$	> 100	100	100
		< 450	450	450
$I_C = 500\text{ }\mu\text{A}; V_{CB} = 10\text{ V}$	$h_{FE}$	> —	120	—
		< —	600	—
$I_C = 10\text{ mA}; V_{CB} = 10\text{ V}$	$h_{FE}$	> —	—	100
		< —	—	600
<b>Transition frequency</b>				
$-I_E = 50\text{ }\mu\text{A}; V_{CB} = 10\text{ V}$	$f_T$	> 10	10	10 MHz
$-I_E = 500\text{ }\mu\text{A}; V_{CB} = 10\text{ V}$	$f_T$	> 50	50	50 MHz
<b>Collector capacitance at <math>f = 1\text{ MHz}</math></b>				
$I_E = I_e = 0; V_{CB} = 10\text{ V}$	$C_c$	< 3,5	3,5	3,5 pF
<b>Noise figures</b>				
$I_C = 50\text{ }\mu\text{A}; V_{CE} = 5\text{ V}; R_S = 10\text{ k}\Omega$ Bandwidth 10 Hz to 15 kHz	F	< 3	4	4 dB
1 kHz spot noise figure $I_C = 50\text{ }\mu\text{A}; V_{CE} = 5\text{ V}; R_S = \text{opt.}$ Bandwidth = 200 Hz	F	< 4	5	5 dB

**CHARACTERISTICS** of the complete device

These characteristics are valid under the following conditions:

- a. Collector-base voltage of both transistors not exceeding 10 V ( $V_{1C-1B} = V_{2C-2B} \leq 10$  V)
- b. Sum of the emitter currents from 10 to 100  $\mu$ A  
 $-(I_{1E} + I_{2E}) = 10$  to 100  $\mu$ A

**MATCHING CHARACTERISTICS**

Ratio of collector currents

$$V_{1B-1E} = V_{2B-2E}$$

$$I_{1C}/I_{2C}$$

Difference between base-emitter voltages

$$I_{1C} = I_{2C}$$

$$|V_{1B-1E} - V_{2B-2E}|$$

Difference between base currents

$$V_{1B-1E} = V_{2B-2E}$$

$$|I_{1B} - I_{2B}|$$

D.C. current gain ratio

$$I_{1C} = I_{2C}$$

$$h_{1FE}/h_{2FE}$$

BCY87	BCY88	BCY89
0,9-1,11	0,8-1,25	0,67-1,5
< 3	6	10 mV
< 25	80	300 nA
0,9-1,11	0,8-1,25	—

**Illustration of matching characteristics**

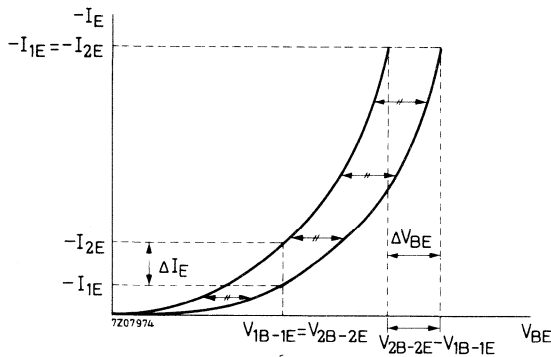

Fig. 2.

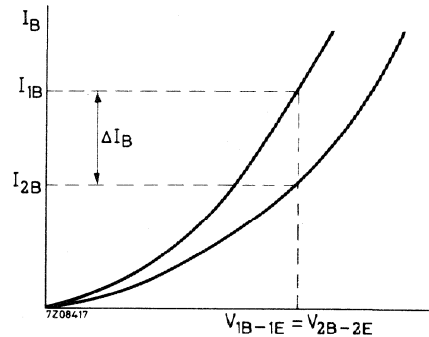

Fig. 3.

$$\frac{I_{2E}}{I_{1E}} = \exp. \frac{q}{KT} \cdot \Delta V_{BE}$$

$$\frac{I_{2E}}{I_{1E}} \text{ measured at } \Delta V_{BE} = 0$$

$$\Delta V_{BE} \text{ measured at } \frac{I_{2E}}{I_{1E}} = 1$$

**CHARACTERISTICS** of the complete device (continued)

**Equivalent circuit for drift**

In the equivalent circuit the transistors are considered to be drift free.

All temperature coefficients are concentrated in the voltage source  $\frac{\Delta V}{\Delta T}$  and in the current source  $\frac{\Delta I}{\Delta T}$ .

It should be noted that the differential current change given is only valid when the source resistances are almost equal; the differential voltage change only when the base-emitter voltages are almost equal.

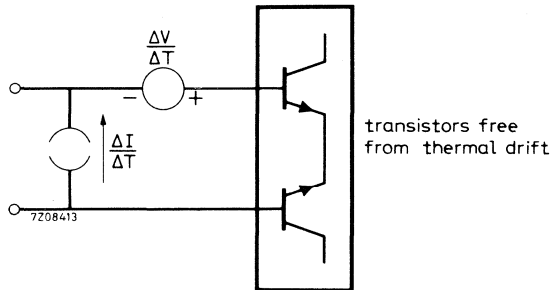

Fig. 4.

**Block symbol of test amplifier**

The test amplifier, used in the tests on page 5, is described on pages 6 and 7. It is represented by the following amplifier symbol:

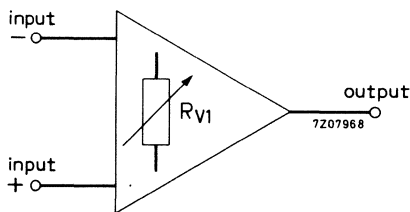

Fig. 5.



Equivalent differential voltage change with temperature

$$T_{amb} = -20 \text{ to } +90 \text{ }^\circ\text{C}$$

$$\left| \frac{\Delta V}{\Delta T} \right|$$

	BCY87	BCY88	BCY89
typ.	1	2	4 $\mu\text{V/K}$
<	3	6	10 $\mu\text{V/K}$

Equivalent differential current change with temperature

$$T_{amb} = -20 \text{ to } +90 \text{ }^\circ\text{C}$$

$$\left| \frac{\Delta I}{\Delta T} \right|$$

<	0,5	2	10 nA/K
---	-----	---	---------

**Test methods**

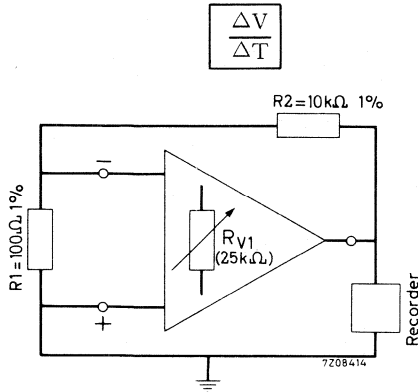

Fig. 6.

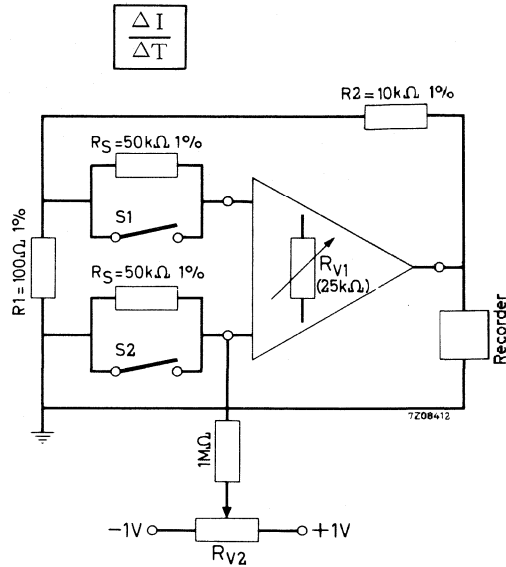

Fig. 7.

**Note**

To prevent contact potentials, connections should be soldered.

Amplification factor determined by feedback circuit:  $\frac{R2}{R1} = 100$

Output voltage against time is recorded.

The temperature of the amplifier is adjusted to  $T_1$  between  $-20$  and  $+90$   $^\circ\text{C}$ . When it has stabilized, the output voltage is brought to zero ( $|V_{T1}| < 1 \text{ mV}$ )\*. The amplifier temperature is then adjusted to  $T_2$  between  $-20$  to  $+90$   $^\circ\text{C}$ . When it has stabilized the output voltage can be read off.

$$\text{Then: } \frac{\Delta V}{\Delta T} = \frac{V_{T2} - V_{T1}}{T_2 - T_1} \cdot \frac{R1}{R2} \text{ or } \frac{\Delta I}{\Delta T} = \frac{V_{T2} - V_{T1}}{T_2 - T_1} \cdot \frac{R1}{R2} \cdot \frac{1}{2R_S}$$

\* For  $\frac{\Delta V}{\Delta T}$  : adjusted by  $R_{V1}$

For  $\frac{\Delta I}{\Delta T}$  : first by  $R_{V1}$  with S1 and S2 closed, then by  $R_{V2}$  with the switches open.

**Differential test-amplifier**

The test amplifier (including feedback resistors, source-resistors and biasing-resistors) should be mounted in a small box to ensure a uniform temperature throughout.

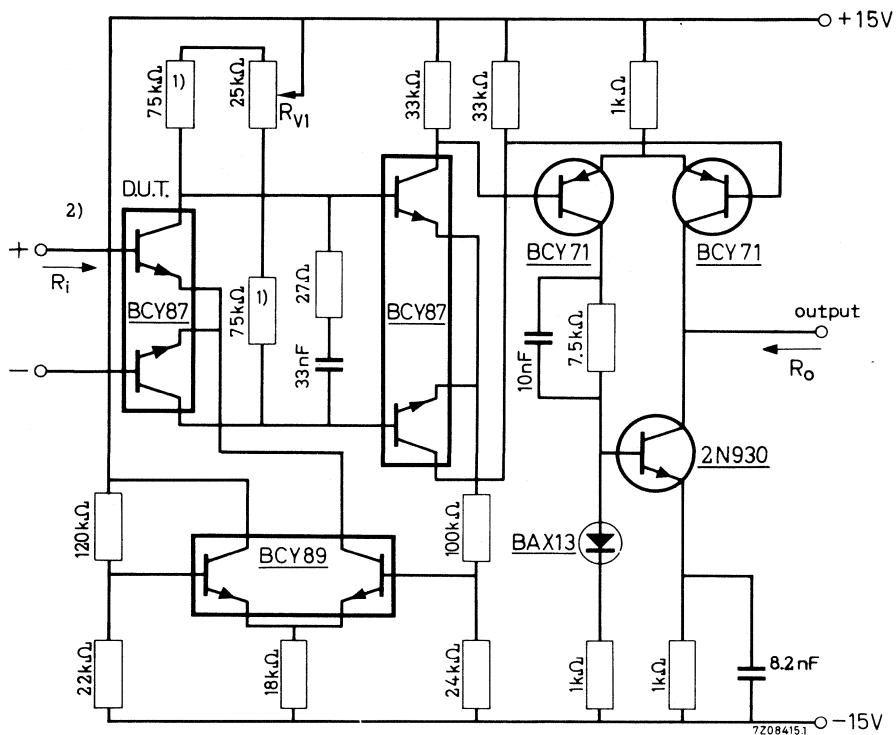

Fig. 8.

- 1) Relative temperature coefficient  $< 10^{-5}/^{\circ}\text{C}$ .
- 2) The device at the input is the device under test.

**Performance of the test amplifier**

Open loop voltage gain ( $Z_L = 10\text{ k}\Omega$ )	$G_V$	typ.	$10^5$
Frequency at which $G_V = 1$	$f_1$	typ.	10 MHz
Maximum common mode input voltage range			$\pm 10\text{ V}$
Maximum output current			$\pm 2,5\text{ mA}$
Maximum output voltage			$\pm 10\text{ V}$
Input resistance	$R_i$		100 k $\Omega$
Output resistance	$R_o$	typ.	20 k $\Omega$
Common mode rejection ratio			$10^5$

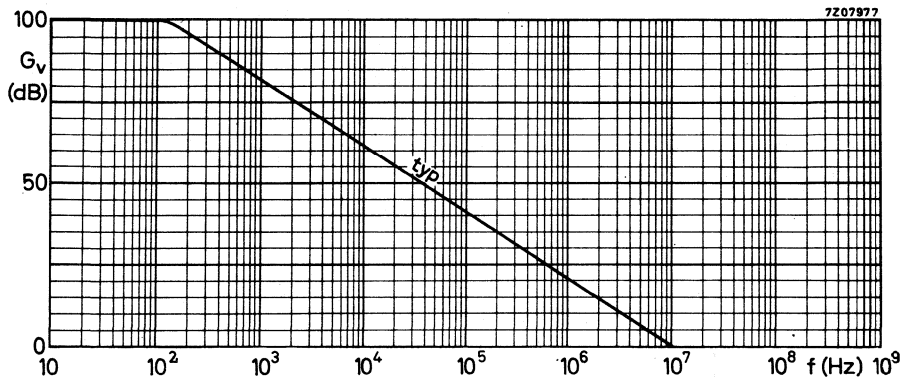

Fig. 9.

**RATINGS**

Limiting values in accordance with the Absolute Maximum System (IEC 134)

Collector-base voltage (open emitter)	$V_{CBO}$	max.	45 V
Collector-emitter voltage (open base)	$V_{CEO}$	max.	40 V
$I_C = 10\text{ mA}$	$V_{EBO}$	max.	5 V
Emitter-base voltage (open collector)	$I_C$	max.	30 mA
Collector current (d.c.)	$P_{tot}$	max.	150 mW
Total power dissipation up to $T_{amb} = 25\text{ }^\circ\text{C}$	$T_{stg}$		$-65\text{ to }+150\text{ }^\circ\text{C}$
Storage temperature range	$T_j$	max.	175 $^\circ\text{C}$
Junction temperature			

**THERMAL RESISTANCE**

From junction to ambient	$R_{thj-a}$	=	1 K/mW
--------------------------	-------------	---	--------





## SILICON PLANAR TRANSISTOR

N-P-N transistor in a plastic TO-92 envelope. The BF198 has a very low feedback capacitance and is intended for use in the forward gain control stage of the television i.f. amplifier.

### QUICK REFERENCE DATA

Collector-base voltage (open emitter)	$V_{CBO}$	max.	40 V
Collector-emitter voltage (open base)	$V_{CEO}$	max.	30 V
Collector current (d.c.)	$I_C$	max.	25 mA
Total power dissipation up to $T_{amb} = 25\text{ }^\circ\text{C}$	$P_{tot}$	max.	500 mW
Junction temperature	$T_j$	max.	150 $^\circ\text{C}$
Transition frequency at $f = 100\text{ MHz}$ $I_C = 4\text{ mA}; V_{CE} = 10\text{ V}$	$f_T$	typ.	400 MHz
Feedback capacitance at $f = 10,7\text{ MHz}$ $I_C = 1\text{ mA}; V_{CE} = 10\text{ V}$	$-C_{re}$	typ.	200 fF

### MECHANICAL DATA

Dimensions in mm

Fig. 1 TO-92.

#### Pinning

- 1 = base
- 2 = emitter
- 3 = collector

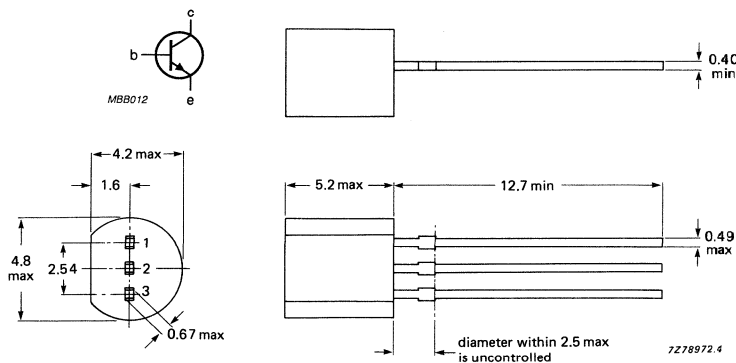

**RATINGS** Limiting values in accordance with the Absolute Maximum System (IEC 134)

Collector-base voltage (open emitter)	$V_{CBO}$	max.	40	V
Collector-emitter voltage (open base)	$V_{CEO}$	max.	30	V
Emitter-base voltage (open collector)	$V_{EBO}$	max.	4	V
Collector current (d. c.)	$I_C$	max.	25	mA
Collector current (peak value)	$I_{CM}$	max.	25	mA
Total power dissipation up to $T_{amb} = 25\text{ }^{\circ}\text{C}$	$P_{tot}$	max.	500	mW
Storage temperature range	$T_{stg}$		-65 to +150	$^{\circ}\text{C}$
Junction temperature	$T_j$	max.	150	$^{\circ}\text{C}$

**THERMAL RESISTANCE**

From junction to ambient in free air	$R_{th\ j-a}$	=	0,25	K/mW
--------------------------------------	---------------	---	------	------

**CHARACTERISTICS**

$T_{amb} = 25\text{ }^{\circ}\text{C}$  unless otherwise specified

Base current at about 50 dB gain control

$I_C = 6\text{ mA}; V_{CE} = 2\text{ V}$   $I_B < 270\text{ }\mu\text{A}$

$I_C = 15\text{ mA}; V_{CE} = 5\text{ V}$   $I_B < 1,5\text{ mA}$

Base current

$I_C = 4\text{ mA}; V_{CE} = 10\text{ V}$   $I_B \begin{matrix} \text{typ.} & 60 & \mu\text{A} \\ < & 150 & \mu\text{A} \end{matrix}$

Base-emitter voltage <sup>1)</sup>

$I_C = 4\text{ mA}; V_{CE} = 10\text{ V}$   $V_{BE} \begin{matrix} \text{typ.} & 760 & \text{mV} \\ < & 850 & \text{mV} \end{matrix}$

Feedback capacitance at  $f = 10.7\text{ MHz}$

$I_C = 1\text{ mA}; V_{CE} = 10\text{ V}$   $-C_{re} \text{ typ. } 200\text{ fF}$

Transition frequency at  $f = 100\text{ MHz}$

$I_C = 4\text{ mA}; V_{CE} = 10\text{ V}$   $f_T \text{ typ. } 400\text{ MHz}$

<sup>1)</sup>  $V_{BE}$  decreases by about 1,7 mV/K with increasing temperature.







## SILICON PLANAR EPITAXIAL TRANSISTOR

N-P-N transistor in a plastic TO-92 envelope.

The BF199 has a very low feedback capacitance and is intended for use in the output stage of a vision i.f. amplifier.

### QUICK REFERENCE DATA

Collector-base voltage (open emitter)	$V_{CBO}$	max.	40 V
Collector-emitter voltage (open base)	$V_{CEO}$	max.	25 V
Collector current (d.c.)	$I_C$	max.	25 mA
Total power dissipation up to $T_{amb} = 25\text{ }^\circ\text{C}$	$P_{tot}$	max.	500 mW
Junction temperature	$T_j$	max.	150 $^\circ\text{C}$
Transition frequency at $f = 100\text{ MHz}$ $I_C = 5\text{ mA}$ ; $V_{CE} = 10\text{ V}$	$f_T$	typ.	550 MHz
Feedback capacitance at $f = 10,7\text{ MHz}$ $I_C = 1\text{ mA}$ ; $V_{CE} = 10\text{ V}$	$C_{re}$	typ.	340 fF

### MECHANICAL DATA

Dimensions in mm

Fig. 1 TO-92.

#### Pinning

- 1 = base
- 2 = emitter
- 3 = collector

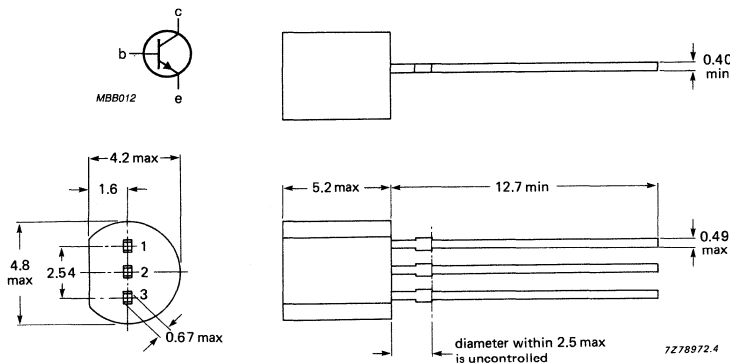

**RATINGS**

Limiting values in accordance with the Absolute Maximum System (IEC 134)

Collector-base voltage (open emitter)	$V_{CB0}$	max.	40 V
Collector-emitter voltage (open base)	$V_{CE0}$	max.	25 V
Emitter-base voltage (open collector)	$V_{EBO}$	max.	4 V
Collector current (d.c.)	$I_C$	max.	25 mA
Collector current (peak value)	$I_{CM}$	max.	25 mA
Total power dissipation up to $T_{amb} = 25\text{ }^\circ\text{C}$	$P_{tot}$	max.	500 mW
Storage temperature range	$T_{stg}$		-65 to +150 $^\circ\text{C}$
Junction temperature	$T_j$	max.	150 $^\circ\text{C}$

**THERMAL RESISTANCE**

From junction to ambient in free air	$R_{thj-a}$	=	0,25 K/mW
--------------------------------------	-------------	---	-----------

**CHARACTERISTICS** $T_{amb} = 25\text{ }^\circ\text{C}$ 

Base current

$I_C = 7\text{ mA}; V_{CE} = 10\text{ V}$	$I_B$	typ.	60 $\mu\text{A}$
		<	185 $\mu\text{A}$

Base-emitter voltage \*

$I_C = 7\text{ mA}; V_{CE} = 10\text{ V}$	$V_{BE}$	typ.	775 mV
		<	925 mV

Transition frequency at  $f = 100\text{ MHz}$ 

$I_C = 5\text{ mA}; V_{CE} = 10\text{ V}$	$f_T$	typ.	550 MHz
---	-------	------	---------

Feedback capacitance at  $f = 10,7\text{ MHz}$ 

$I_C = 1\text{ mA}; V_{CE} = 10\text{ V}$	$C_{re}$	typ.	340 fF
---	----------	------	--------

\*  $V_{BE}$  decreases by about 1,7 mV/K with increasing temperature.



## HF SILICON PLANAR EPITAXIAL TRANSISTORS

NPN transistors in a plastic envelope, recommended for AM mixers and IF amplifiers in AM/FM receivers.

### QUICK REFERENCE DATA

Collector-base voltage (open emitter)	$V_{CBO}$	max.	40 V																								
Collector-emitter voltage (open base)	$V_{CEO}$	max.	40 V																								
Collector current (DC)	$I_C$	max.	25 mA																								
Total power dissipation up to $T_{amb} = 25^\circ C$	$P_{tot}$	max.	300 mW																								
Junction temperature	$T_j$	max.	150 $^\circ C$																								
			<table border="1"> <thead> <tr> <th></th> <th>BF240</th> <th>BF241</th> </tr> </thead> <tbody> <tr> <td>DC current gain</td> <td></td> <td></td> </tr> <tr> <td><math>I_C = 1 \text{ mA}; V_{CE} = 10 \text{ V}</math></td> <td><math>h_{FE}</math></td> <td>67 to 220</td> <td>35 to 125 <math>\mu A</math></td> </tr> <tr> <td>Transition frequency</td> <td></td> <td></td> </tr> <tr> <td><math>I_C = 1 \text{ mA}; V_{CE} = 10 \text{ V}</math></td> <td><math>f_T</math></td> <td>min. 150</td> <td>MHz</td> </tr> <tr> <td>Feedback capacitance at <math>f = 1 \text{ MHz}</math></td> <td></td> <td></td> </tr> <tr> <td><math>I_C = 1 \text{ mA}; V_{CE} = 10 \text{ V}</math></td> <td><math>-C_{re}</math></td> <td>max.</td> <td>0.34 pF</td> </tr> </tbody> </table>		BF240	BF241	DC current gain			$I_C = 1 \text{ mA}; V_{CE} = 10 \text{ V}$	$h_{FE}$	67 to 220	35 to 125 $\mu A$	Transition frequency			$I_C = 1 \text{ mA}; V_{CE} = 10 \text{ V}$	$f_T$	min. 150	MHz	Feedback capacitance at $f = 1 \text{ MHz}$			$I_C = 1 \text{ mA}; V_{CE} = 10 \text{ V}$	$-C_{re}$	max.	0.34 pF
	BF240	BF241																									
DC current gain																											
$I_C = 1 \text{ mA}; V_{CE} = 10 \text{ V}$	$h_{FE}$	67 to 220	35 to 125 $\mu A$																								
Transition frequency																											
$I_C = 1 \text{ mA}; V_{CE} = 10 \text{ V}$	$f_T$	min. 150	MHz																								
Feedback capacitance at $f = 1 \text{ MHz}$																											
$I_C = 1 \text{ mA}; V_{CE} = 10 \text{ V}$	$-C_{re}$	max.	0.34 pF																								

### MECHANICAL DATA

Dimensions in mm

Fig. 1 TO-92.

#### Pinning

- 1 = base
- 2 = emitter
- 3 = collector

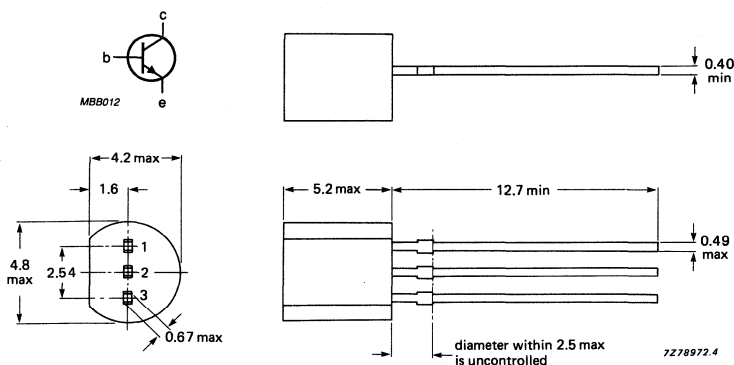

**RATINGS**

Limiting values in accordance with the Absolute Maximum System (IEC 134).

Collector-base voltage (open emitter)	$V_{CB0}$	max.	40 V
Collector-emitter voltage (open base)	$V_{CE0}$	max.	40 V
Emitter-base voltage (open collector)	$V_{EB0}$	max.	4 V
Collector current (DC)	$I_C$	max.	25 mA
Total power dissipation up to $T_{amb} = 25\text{ }^{\circ}\text{C}$	$P_{tot}$	max.	300 mW
Storage temperature range	$T_{stg}$		-65 to +150 $^{\circ}\text{C}$
Junction temperature	$T_j$	max.	150 $^{\circ}\text{C}$

**THERMAL RESISTANCE**

From junction to ambient in free air	$R_{thj-a}$	=	420 K/W
--------------------------------------	-------------	---	---------

**CHARACTERISTICS**

$T_{amb} = 25\text{ }^{\circ}\text{C}$  unless otherwise specified

Collector cut-off current

$I_E = 0; V_{CB} = 20\text{ V}$

$I_E = 0; V_{CB} = 20\text{ V}; T_{amb} = 150\text{ }^{\circ}\text{C}$

$I_{CBO}$	max.	100 nA
$I_{CBO}$	max.	4 $\mu\text{A}$

Base-emitter voltage

$I_C = 1\text{ mA}; V_{CE} = 10\text{ V}$

$V_{BE}$	typ.	700 mV
		650 to 740 mV

DC current gain

$I_C = 1\text{ mA}; V_{CE} = 10\text{ V}$

	BF240	BF241
$h_{FE}$	67 to 220	35 to 125

Transition frequency at  $f = 100\text{ MHz}$

$I_C = 1\text{ mA}; V_{CE} = 10\text{ V}$

$f_T$	min.	150	MHz
-------	------	-----	-----

Feedback capacitance at  $f = 1\text{ MHz}$

$I_C = 1\text{ mA}; V_{CE} = 10\text{ V}$

$C_{re}$	max.	0.34	pF
----------	------	------	----

Emitter-base cut-off current

$I_C = 0; V_{EB} = 3\text{ V}$

$I_{EBO}$	max.	100	nA
-----------	------	-----	----



## H.F. SILICON PLANAR EPITAXIAL TRANSISTOR

P-N-P transistor in a plastic envelope especially intended for r.f. stages in f.m. front-ends in common base configuration.

### QUICK REFERENCE DATA

Collector-base voltage (open emitter)	$-V_{CBO}$ max.	30 V
Collector-emitter voltage (open base)	$-V_{CEO}$ max.	30 V
Collector current (d.c.)	$-I_C$ max.	25 mA
Total power dissipation up to $T_{amb} = 45\text{ }^\circ\text{C}$	$P_{tot}$ max.	250 mW
Junction temperature	$T_j$ max.	150 $^\circ\text{C}$
Base current	$-I_B$ typ.	80 $\mu\text{A}$
$-I_C = 4\text{ mA}; -V_{CE} = 10\text{ V}$	$-I_B$ >	160 $\mu\text{A}$
Transition frequency	$f_T$ typ.	450 MHz
$-I_C = 4\text{ mA}; -V_{CE} = 10\text{ V}$		
Noise figure at $f = 100\text{ MHz}$	F typ.	3 dB
$-I_C = 2\text{ mA}; -V_{CE} = 10\text{ V}; G_S = 16,7\text{ mA/V}$		
Feedback capacitance at $f = 1\text{ MHz}$	$C_{rb}$ typ.	0,1 pF
$V_{EB} = 0; -V_{CB} = 10\text{ V}$		

### MECHANICAL DATA

Dimensions in mm

Fig. 1 TO-92.

#### Pinning

- 1 = emitter
- 2 = base
- 3 = collector

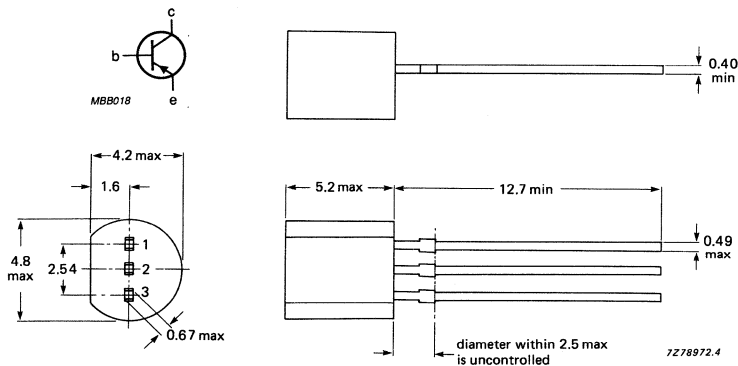

**RATINGS**

Limiting values in accordance with the Absolute Maximum System (IEC 134)

Collector-base voltage (open emitter)	$-V_{CBO}$	max.	30 V
Collector-emitter voltage (open base)	$-V_{CEO}$	max.	30 V
Emitter-base voltage (open collector)	$-V_{EBO}$	max.	4 V
Collector current (d.c.)	$-I_C$	max.	25 mA
Total power dissipation up to $T_{amb} = 45\text{ }^{\circ}\text{C}$	$P_{tot}$	max.	250 mW
Storage temperature	$T_{stg}$		$-65$ to $+150\text{ }^{\circ}\text{C}$
Junction temperature	$T_j$	max.	150 $^{\circ}\text{C}$

**THERMAL RESISTANCE**

From junction to ambient in free air	$R_{th\ j-a}$	=	420 K/W
--------------------------------------	---------------	---	---------

**CHARACTERISTICS** $T_j = 25\text{ }^\circ\text{C}$  unless otherwise specified

Collector cut-off current

$$I_E = 0; -V_{CB} = 30\text{ V} \quad -I_{CBO} < 50\text{ nA}$$

Emitter cut-off current

$$I_C = 0; -V_{EB} = 4\text{ V} \quad -I_{EBO} < 10\text{ }\mu\text{A}$$

Base current

$$-I_C = 4\text{ mA}; -V_{CE} = 10\text{ V} \quad -I_B \begin{array}{l} \text{typ.} \\ < \end{array} \begin{array}{l} 80 \\ 160 \end{array} \begin{array}{l} \mu\text{A} \\ \mu\text{A} \end{array}$$

$$-I_C = 1\text{ mA}; -V_{CE} = 10\text{ V} \quad -I_B \text{ typ. } 22\text{ }\mu\text{A}$$

Base-emitter voltage

$$-I_C = 4\text{ mA}; -V_{CE} = 10\text{ V} \quad -V_{BE} \text{ typ. } 0,76\text{ V}$$

Transition frequency at  $f = 100\text{ MHz}$ 

$$-I_C = 1\text{ mA}; -V_{CE} = 10\text{ V} \quad f_T \text{ typ. } 350\text{ MHz}$$

$$-I_C = 4\text{ mA}; -V_{CE} = 10\text{ V} \quad f_T \text{ typ. } 450\text{ MHz}$$

$$-I_C = 8\text{ mA}; -V_{CE} = 10\text{ V} \quad f_T \text{ typ. } 440\text{ MHz}$$

Feedback capacitance at  $f = 1\text{ MHz}$ 

$$V_{EB} = 0; -V_{CB} = 10\text{ V} \quad C_{rb} \text{ typ. } 0,1\text{ pF}$$

Noise factor at  $f = 100\text{ MHz}$ 

$$\begin{array}{l} -I_C = 2\text{ mA}; -V_{CE} = 10\text{ V}; \\ G_S = 16,7\text{ mS} \end{array} \quad F \text{ typ. } 3\text{ dB}$$

$$\begin{array}{l} -I_C = 5\text{ mA}; -V_{CE} = 10\text{ V}; \\ G_S = 6,7\text{ mA/V}; -jB_S = 5\text{ mS} \end{array} \quad F \text{ typ. } 3,5\text{ dB}$$

y-parameters (common base) at  $f = 100\text{ MHz}$ 

$$-I_C = 4\text{ mA}; -V_{CB} = 10\text{ V}$$

$$\text{Input conductance} \quad g_{ib} \text{ typ. } 125\text{ mS}$$

$$\text{Input capacitance} \quad -C_{ib} \text{ typ. } 64\text{ pF}$$

$$\text{Transfer admittance} \quad |y_{fb}| \text{ typ. } 100\text{ mS}$$

$$\text{Phase angle of transfer admittance} \quad \varphi_{fb} \text{ typ. } 147^\circ$$

$$\text{Output conductance} \quad g_{ob} \text{ typ. } 40\text{ }\mu\text{S}$$

$$\text{Output capacitance} \quad C_{ob} \text{ typ. } 1,25\text{ pF}$$

$$\text{Feedback admittance} \quad |y_{rb}| \text{ typ. } 220\text{ }\mu\text{S}$$

$$\text{Phase angle of feedback admittance} \quad -\varphi_{rb} \text{ typ. } 85^\circ$$

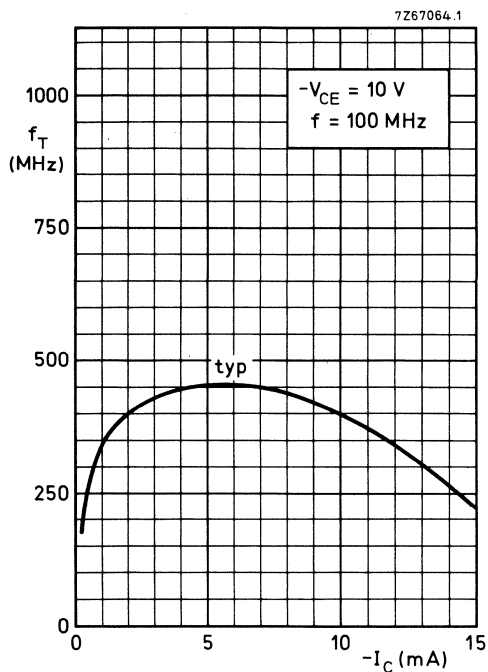

Fig. 2

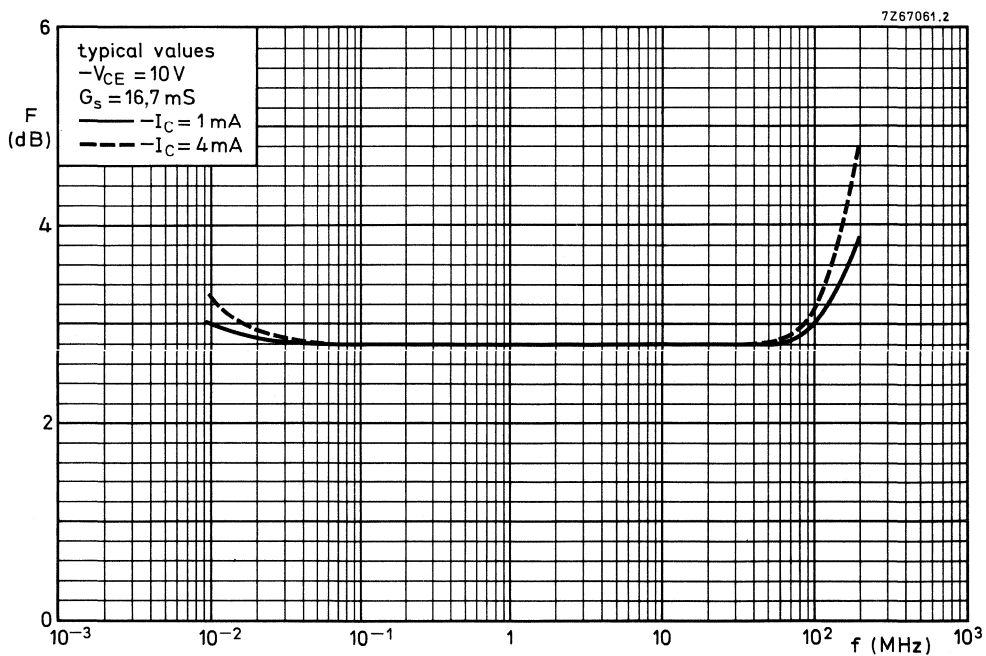

Fig. 3



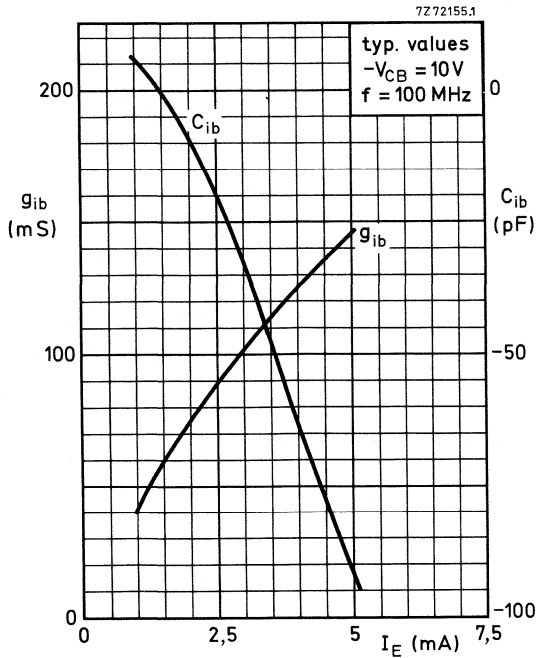

Fig. 4

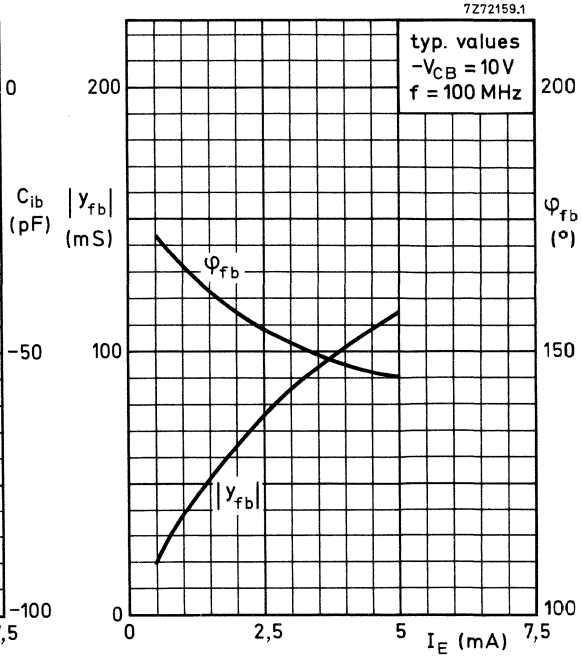

Fig. 5

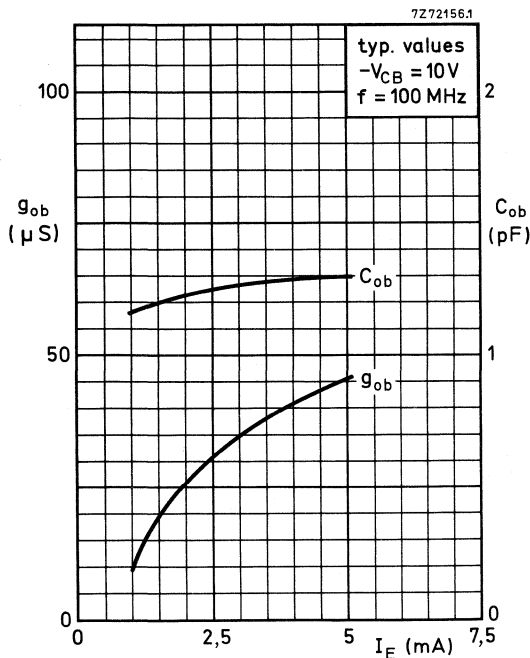

Fig. 6

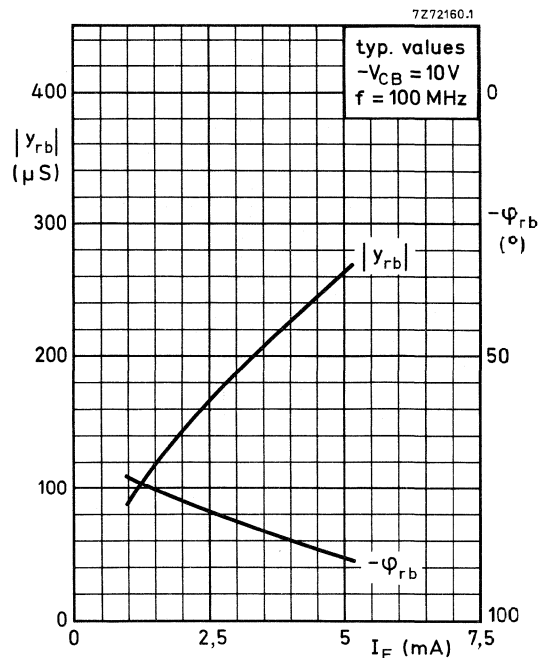

Fig. 7

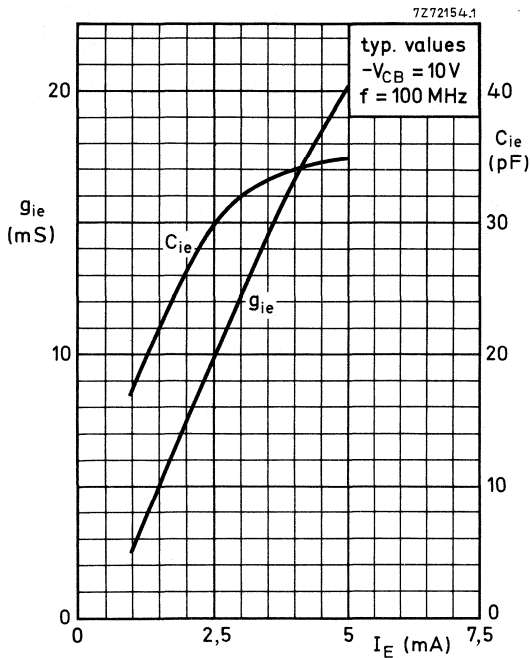

Fig. 8

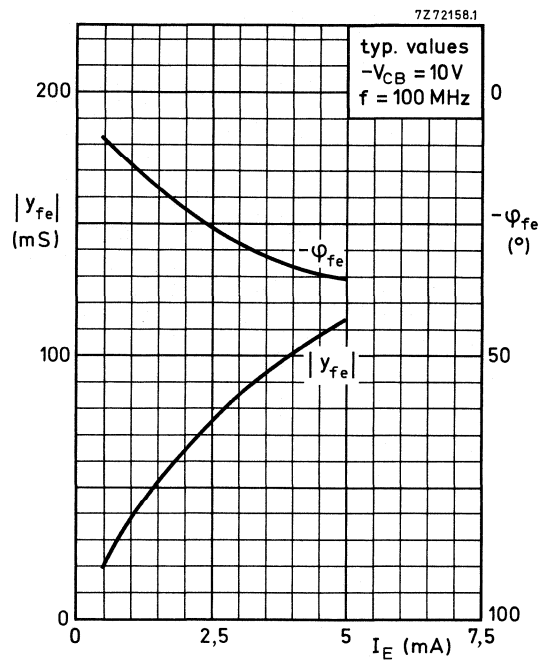

Fig. 9

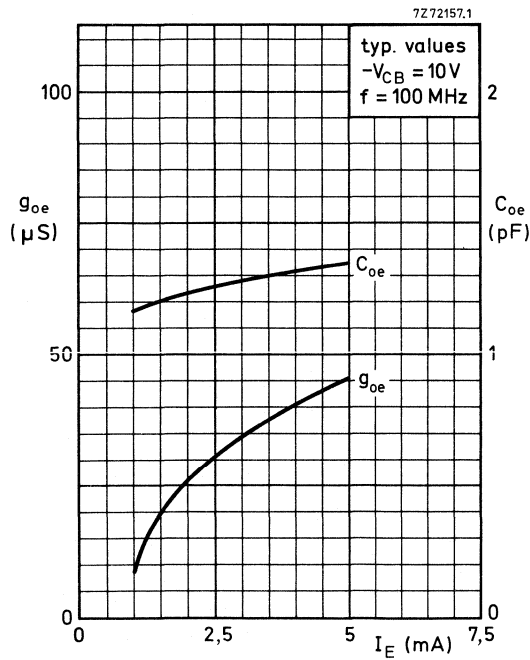

Fig. 10

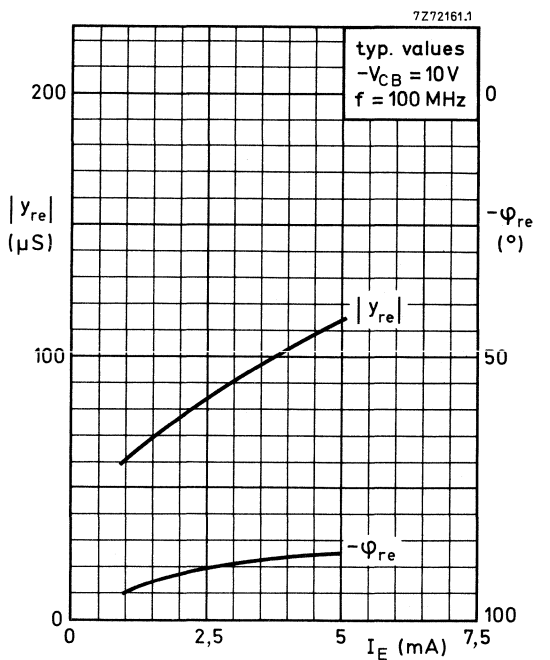

Fig. 11



## SILICON PLANAR EPITAXIAL TRANSISTOR

N-P-N transistor in a plastic TO-92 envelope, intended for use in large-signal handling i.f. pre-amplifiers of TV receivers in combination with surface acoustic wave filters.

### QUICK REFERENCE DATA

Collector-base voltage (open emitter)	$V_{CBO}$	max.	40 V
Collector-emitter voltage (open base)	$V_{CEO}$	max.	15 V
Collector current (d.c.)	$I_C$	max.	100 mA
Total power dissipation up to $T_{amb} = 25\text{ }^\circ\text{C}$	$P_{tot}$	max.	500 mW
Junction temperature	$T_j$	max.	150 $^\circ\text{C}$
D.C. current gain $I_C = 10\text{ mA}; V_{CE} = 1\text{ V}$	$h_{FE}$	>	40
Transition frequency at $f = 100\text{ MHz}$ $I_C = 40\text{ mA}; V_{CE} = 10\text{ V}$	$f_T$	>	490 MHz
Voltage gain at $f = 36\text{ MHz}$ (see Fig. 4) $I_C = 20\text{ mA}; V_{CE} \approx 10,4\text{ V}$	$G_v$	typ.	24 dB
Interference voltage for $K = 1\%$ (see Fig. 4)	$V_{(int)rms}$	typ.	120 mV

### MECHANICAL DATA

Dimensions in mm

Fig. 1 TO-92.

#### Pinning

- 1 = emitter
- 2 = base
- 3 = collector

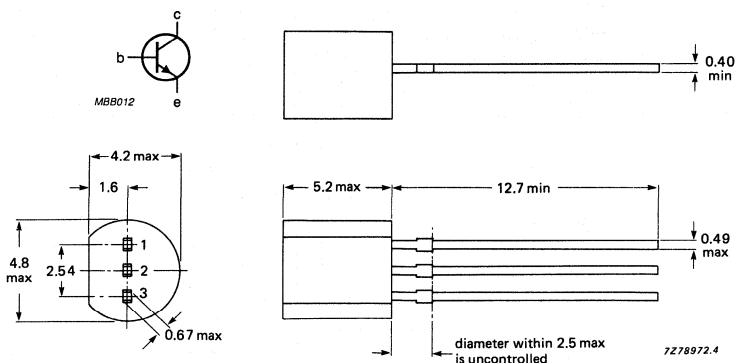

**RATINGS**

Limiting values in accordance with the Absolute Maximum System (IEC 134)

Collector-base voltage (open emitter)	$V_{CBO}$	max.	40 V
Collector-emitter voltage (open base)	$V_{CEO}$	max.	15 V
Emitter-base voltage (open collector)	$V_{EBO}$	max.	4,5 V
Collector current (d.c.)	$I_C$	max.	100 mA
Total power dissipation up to $T_{amb} = 25\text{ }^\circ\text{C}$	$P_{tot}$	max.	500 mW
Storage temperature	$T_{stg}$		-65 to +150 $^\circ\text{C}$
Junction temperature	$T_j$	max.	150 $^\circ\text{C}$

**THERMAL RESISTANCE**

From junction to ambient in free air  $R_{th\ j-a} = 250\text{ K/W}$

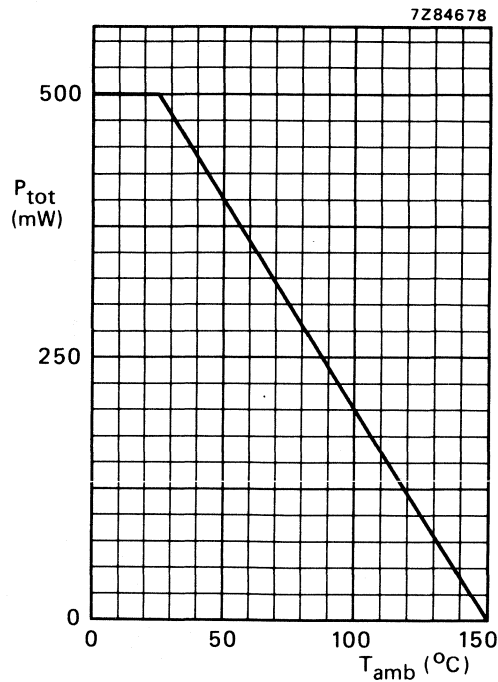

Fig. 2 Power dissipation derating curve as a function of ambient temperature.

## CHARACTERISTICS

$T_j = 25\text{ }^\circ\text{C}$  unless otherwise specified

Collector cut-off current

$$I_E = 0; V_{CB} = 20\text{ V}$$

$$I_{CBO} < 400\text{ nA}$$

$$I_E = 0; V_{CB} = 20\text{ V}; T_j = 125\text{ }^\circ\text{C}$$

$$I_{CBO} < 30\text{ }\mu\text{A}$$

Emitter cut-off current

$$I_C = 0; V_{EB} = 2\text{ V}$$

$$I_{EBO} < 100\text{ nA}$$

D.C. current gain

$$I_C = 10\text{ mA}; V_{CE} = 1\text{ V}$$

$$h_{FE} > 40$$

Transition frequency at  $f = 100\text{ MHz}$

$$I_C = 10\text{ mA}; V_{CE} = 10\text{ V}$$

$$f_T > 500\text{ MHz}$$

$$I_C = 40\text{ mA}; V_{CE} = 10\text{ V}$$

$$f_T > 490\text{ MHz}$$

Collector capacitance at  $f = 1\text{ MHz}$

$$I_E = I_e = 0; V_{CB} = 10\text{ V}$$

$$C_c \text{ typ. } 2,2\text{ pF}$$

Emitter capacitance at  $f = 1\text{ MHz}$

$$I_C = I_c = 0; V_{EB} = 1\text{ V}$$

$$C_e < 4,5\text{ pF}$$

Feedback capacitance at  $f = 1\text{ MHz}$

$$I_C = 0; V_{CE} = 10\text{ V}$$

$$C_{re} \text{ typ. } 1,6\text{ pF}$$

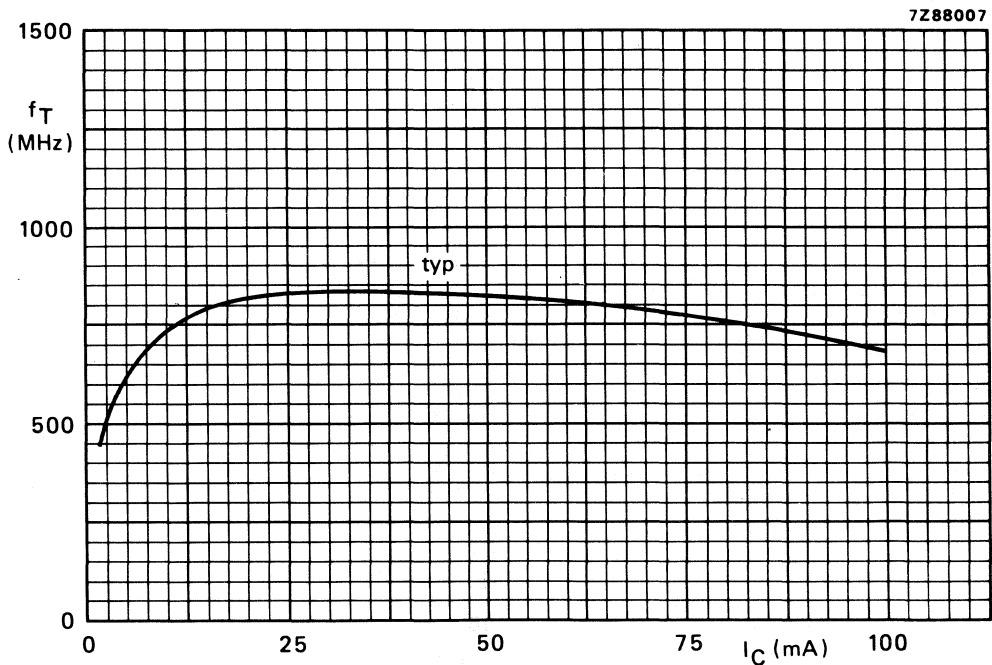
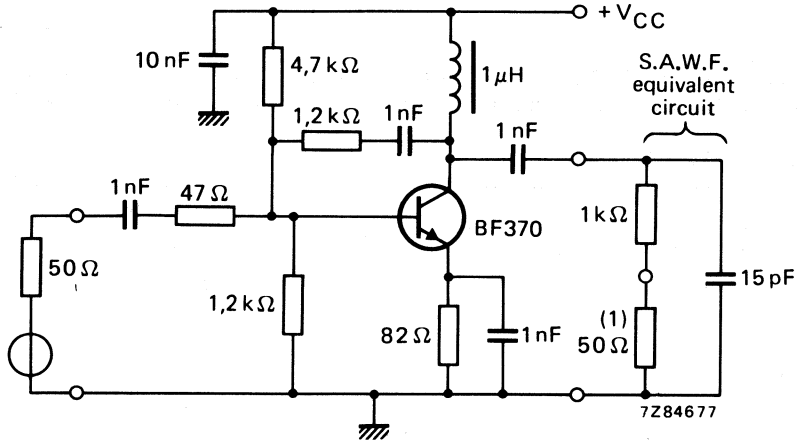

Fig. 3  $V_{CE} = 10\text{ V}; T_j = 25\text{ }^\circ\text{C}$ .

APPLICATION INFORMATION



(1) Test instrument load.

Fig. 4 Large-signal handling i.f. preamplifier for surface acoustic wave filter.

Performance

Supply voltage

$V_{CC} = 12 \text{ V}$

Collector current

$I_C = 20 \text{ mA}$

Measuring frequency

$f_i = 36 \text{ MHz}$

Input impedance

$Z_i \text{ typ. } 50 \Omega // 1 \text{ pF}$

Output impedance

$Z_o < 100 \Omega$

Voltage gain

$$G_V \text{ (in dB)} = 20 \log \frac{V_o}{V_i}$$

$G_V \text{ typ. } 24 \text{ dB}$

Interference voltage for  $K = 1\%*$

$V_{(int)rms} \text{ typ. } 120 \text{ mV}$

\* Input terminal voltage at 50 Ω internal resistance of signal generator, interference frequency 40 MHz, 80% modulated with 1 kHz.



## SILICON EPITAXIAL TRANSISTORS

N-P-N transistors in plastic TO-92 envelope primarily intended for class-B video output stages in colour television and professional monitor equipment. P-N-P complements are BF421 and BF423.

### QUICK REFERENCE DATA

			BF420	BF422
Collector-base voltage (open emitter)	$V_{CBO}$	max.	300	250 V
Collector-emitter voltage	$V_{CER}$	max.	300	V
	$V_{CEO}$	max.		250 V
Collector current (peak value)	$I_{CM}$	max.	100	mA
Total power dissipation up to $T_{amb} = 25\text{ }^{\circ}\text{C}$	$P_{tot}$	max.	830	mW
Junction temperature	$T_j$	max.	150	$^{\circ}\text{C}$
D.C. current gain at $T_j = 25\text{ }^{\circ}\text{C}$ $I_C = 25\text{ mA}; V_{CE} = 20\text{ V}$	$h_{FE}$	>	50	
Transition frequency $I_C = 10\text{ mA}; V_{CE} = 10\text{ V}$	$f_T$	>	60	MHz
Feedback capacitance at $f = 1\text{ MHz}$ $I_C = 0; V_{CE} = 30\text{ V}$	$C_{re}$	<	1,6	pF

### MECHANICAL DATA

Dimensions in mm

Fig. 1 TO-92.

#### Pinning

- 1 = base
- 2 = collector
- 3 = emitter

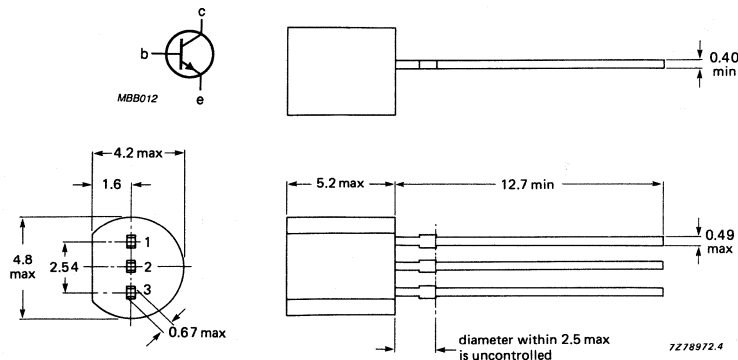

**RATINGS**

Limiting values in accordance with the Absolute Maximum System (IEC 134)

		BF420	BF422
Collector-base voltage (open emitter)	$V_{CBO}$ max.	300	250 V
Collector-emitter voltage $R_{BE} = 2,7 \text{ k}\Omega$ $I_B = 0$	$V_{CER}$ max.	300	V
	$V_{CEO}$ max.		250 V
Emitter-base voltage (open collector)	$V_{EBO}$ max.	5	V
Collector current (d.c.)	$I_C$ max.	50	mA
Collector current (peak value)	$I_{CM}$ max.	100	mA
Total power dissipation up to $T_{amb} = 25 \text{ }^\circ\text{C}^*$	$P_{tot}$ max.	830	mW
Storage temperature	$T_{stg}$	-65 to + 150	$^\circ\text{C}$
Junction temperature	$T_j$ max.	150	$^\circ\text{C}$

**THERMAL RESISTANCE**

From junction to ambient*	$R_{th \text{ j-a}}$ =	150	K/W
---------------------------	------------------------	-----	-----

**CHARACTERISTICS**

$T_j = 25 \text{ }^\circ\text{C}$  unless otherwise specified.

		BF420	BF422
Collector cut-off currents $I_E = 0; V_{CB} = 200 \text{ V}$ $R_{BE} = 2,7 \text{ k}\Omega; V_{CE} = 200 \text{ V}; T_j = 150 \text{ }^\circ\text{C}$	$I_{CBO} <$	10	10 nA
	$I_{CER} <$	10	10 $\mu\text{A}$
Emitter cut-off current $I_C = 0; V_{EB} = 5 \text{ V}$	$I_{EBO} <$	10	$\mu\text{A}$
D.C. current gain $I_C = 25 \text{ mA}; V_{CE} = 20 \text{ V}$	$h_{FE} >$	50	
High-frequency knee voltage** $I_C = 25 \text{ mA}; T_j = 150 \text{ }^\circ\text{C}$	$V_{CEK}$ typ.	20	V
Saturation voltage $I_C = 30 \text{ mA}; I_B = 5 \text{ mA}$	$V_{CEsat} <$	0,6	V
Transition frequency $I_C = 10 \text{ mA}; V_{CE} = 10 \text{ V}$	$f_T >$	60	MHz
Feedback capacitance at $f = 1 \text{ MHz}$ $I_C = 0; V_{CE} = 30 \text{ V}$	$C_{re} <$	1,6	pF

\* Transistor mounted on a printed-circuit board, mounting pad for collector lead minimum 10 mm x 10 mm; maximum length 4 mm.

\*\* The high-frequency knee voltage of a transistor is that value of the collector-emitter voltage at which the small-signal gain, measured in a practical circuit, has dropped to 80% of the gain at  $V_{CE} = 50 \text{ V}$ . A further reduction of the collector-emitter voltage results in a rapid increase of the distortion of the signal.



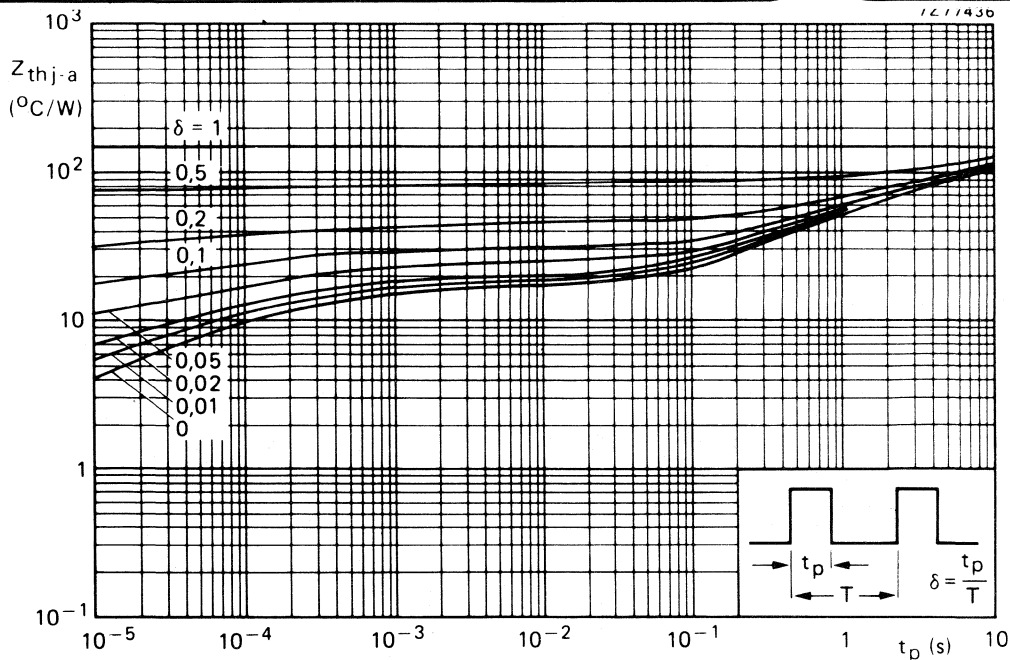

Fig. 2 Thermal impedance from junction to ambient versus pulse duration. Maximum lead length 3 mm; mounting pad for collector lead minimum 10 mm x 10 mm.

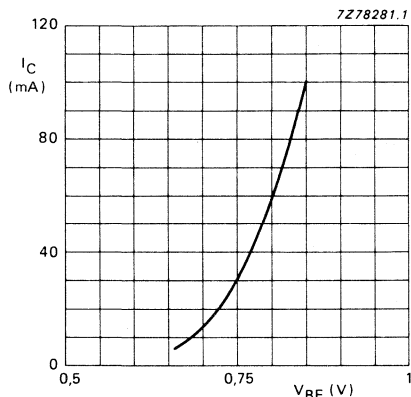

Fig. 3.  $V_{CE} = 20$  V;  $T_j = 25$   $^{\circ}C$ .

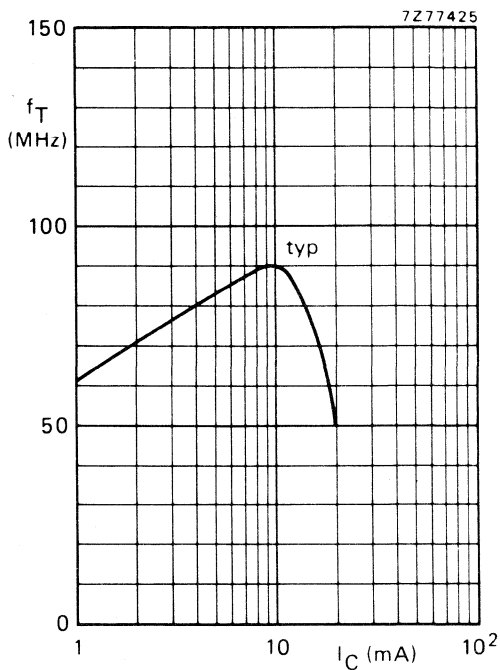

Fig. 4  $V_{CE} = 10$  V;  $T_j = 25$   $^{\circ}C$ ;  $f = 35$  MHz.

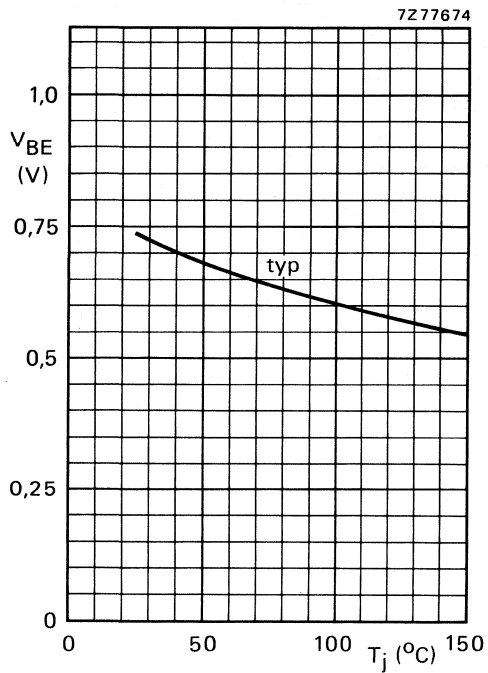

Fig. 5  $I_C = 25$  mA;  $V_{CE} = 20$  V.

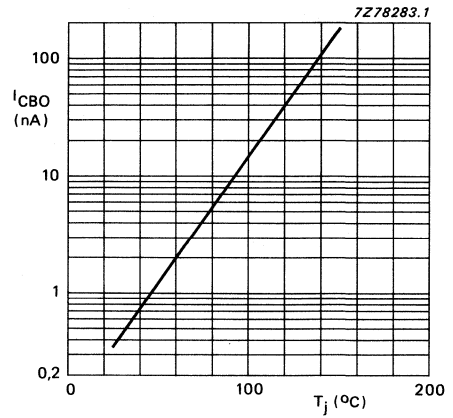

Fig. 6  $V_{CB} = 200$  V; typical values.

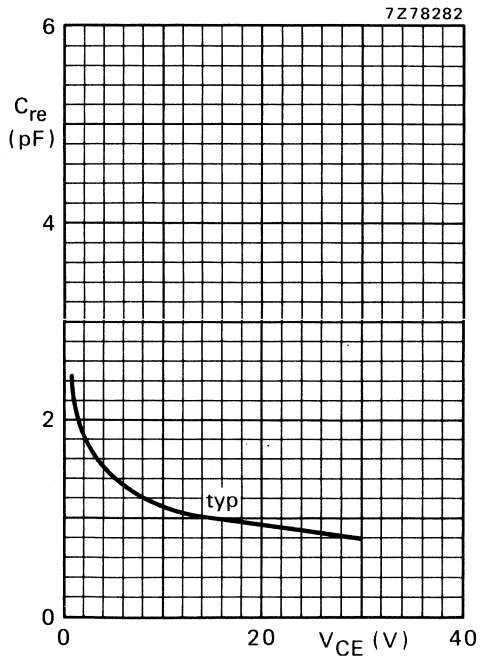

Fig. 7  $I_C = 0$ ;  $f = 1$  MHz;  $T_j = 25$  °C.

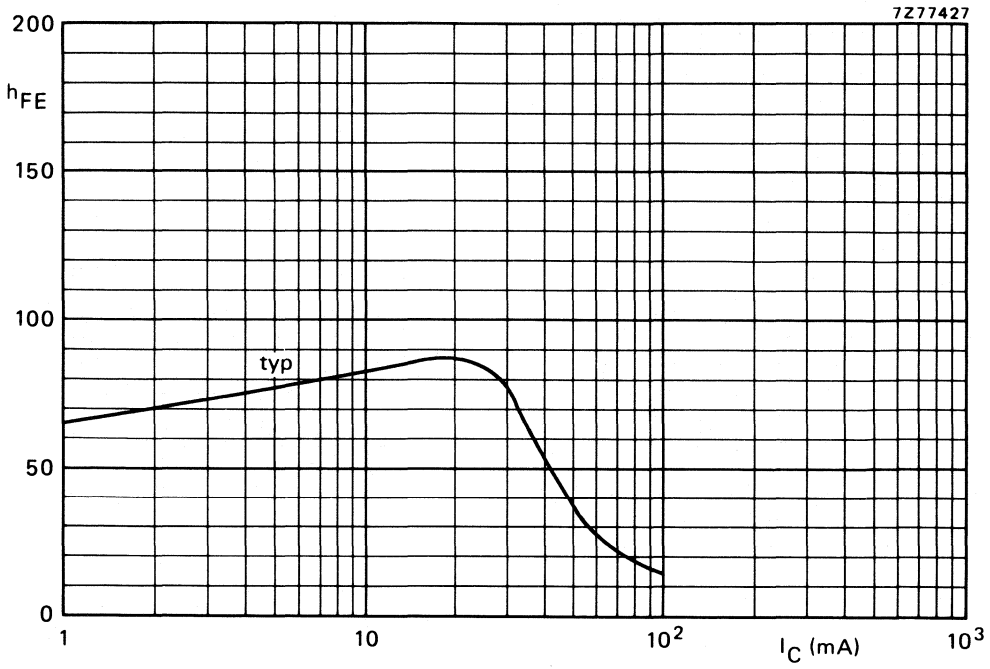

Fig. 8  $V_{CE} = 20 \text{ V}$ ;  $T_j = 25 \text{ }^\circ\text{C}$ .





## SILICON EPITAXIAL TRANSISTORS

P-N-P transistors in plastic TO-92 envelope primarily intended for class-B video output stages in colour television and professional monitor equipment. N-P-N complements are BF420 and BF422.

### QUICK REFERENCE DATA

		BF421	BF423
Collector-base voltage (open emitter)	$-V_{CBO}$ max.	300	250 V
Collector-emitter voltage ( $R_{BE} = 2.7 \text{ k}\Omega$ ) (open base)	$-V_{CER}$ max.	300	V
	$-V_{CEO}$ max.		250 V
Collector current (peak value)	$-I_{CM}$ max.	100	mA
Total power dissipation up to $T_{amb} = 25 \text{ }^\circ\text{C}$	$P_{tot}$ max.	830	mW
Junction temperature	$T_j$ max.	150	$^\circ\text{C}$
D.C. current gain at $T_j = 25 \text{ }^\circ\text{C}$ $-I_C = 25 \text{ mA}; -V_{CE} = 20 \text{ V}$	$h_{FE}$	>	50
	Transition frequency $-I_C = 10 \text{ mA}; -V_{CE} = 10 \text{ V}$	$f_T$	>
Feedback capacitance at $f = 1 \text{ MHz}$ $-I_C = 0; -V_{CE} = 30 \text{ V}$	$C_{re}$	<	1,6 pF

### MECHANICAL DATA

Dimensions in mm

Fig. 1 TO-92.

#### Pinning:

- 1 = base
- 2 = collector
- 3 = emitter

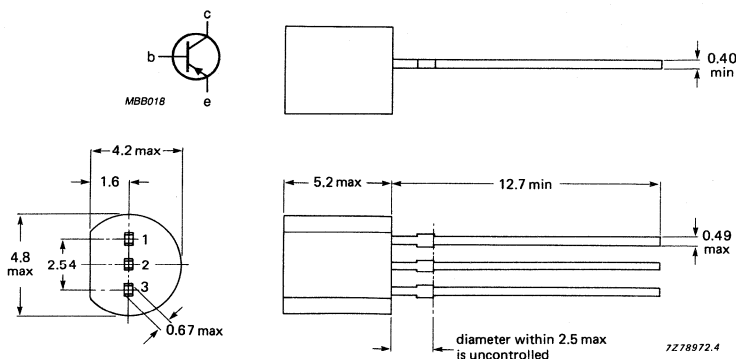

# BF421 BF423

## RATINGS

Limiting values in accordance with the Absolute Maximum System (IEC 134)

		BF421	BF423
Collector-base voltage (open emitter)	$-V_{CBO}$ max.	300	250 V
Collector-emitter voltage $R_{BE} = 2,7 \text{ k}\Omega$ $I_B = 0$	$-V_{CER}$ max.	300	V
	$-V_{CEO}$ max.		250 V
Emitter-base voltage (open collector)	$-V_{EBO}$ max.	5	V
Collector current (d.c.)	$-I_C$ max.	50	mA
Collector current (peak value)	$-I_{CM}$ max.	100	mA
Total power dissipation up to $T_{amb} = 25 \text{ }^\circ\text{C}^*$	$P_{tot}$ max.	830	mW
Storage temperature	$T_{stg}$	-65 to +150	$^\circ\text{C}$
Junction temperature	$T_j$ max.	150	$^\circ\text{C}$

## THERMAL RESISTANCE

From junction to ambient*	$R_{th \text{ j-a}}$ =	150	K/W
---------------------------	------------------------	-----	-----

## CHARACTERISTICS

$T_j = 25 \text{ }^\circ\text{C}$  unless otherwise specified.

		BF421	BF423
Collector cut-off currents $I_E = 0; -V_{CB} = 200 \text{ V}$ $R_{BE} = 2,7 \text{ k}\Omega; -V_{CE} = 200 \text{ V}; T_j = 150 \text{ }^\circ\text{C}$	$-I_{CBO} <$	10	10 nA
	$-I_{CER} <$	10	10 $\mu\text{A}$
Emitter cut-off current $I_C = 0; -V_{EB} = 5 \text{ V}$	$-I_{EBO} <$	10	$\mu\text{A}$
D.C. current gain $-I_C = 25 \text{ mA}; -V_{CE} = 20 \text{ V}$	$h_{FE} >$	50	
High-frequency knee voltage** $-I_C = 25 \text{ mA}; T_j = 150 \text{ }^\circ\text{C}$	$-V_{CEK}$ typ.	20	V
Saturation voltage $-I_C = 30 \text{ mA}; -I_B = 5 \text{ mA}$	$-V_{CE \text{ sat}} <$	0,6	V
Transition frequency $-I_C = 10 \text{ mA}; -V_{CE} = 10 \text{ V}$	$f_T >$	60	MHz
Feedback capacitance at $f = 1 \text{ MHz}$ $-I_C = 0; -V_{CE} = 30 \text{ V}$	$C_{re} <$	1,6	pF

\* Transistor mounted on a printed-circuit board, mounting pad for collector lead minimum 10 mm x 10 mm; maximum length 4 mm.

\*\* The high-frequency knee voltage of a transistor is that value of the collector-emitter voltage at which the small-signal gain, measured in a practical circuit, has dropped to 80% of the gain at  $V_{CE} = 50 \text{ V}$ . A further reduction of the collector-emitter voltage results in a rapid increase of the distortion of the signal.

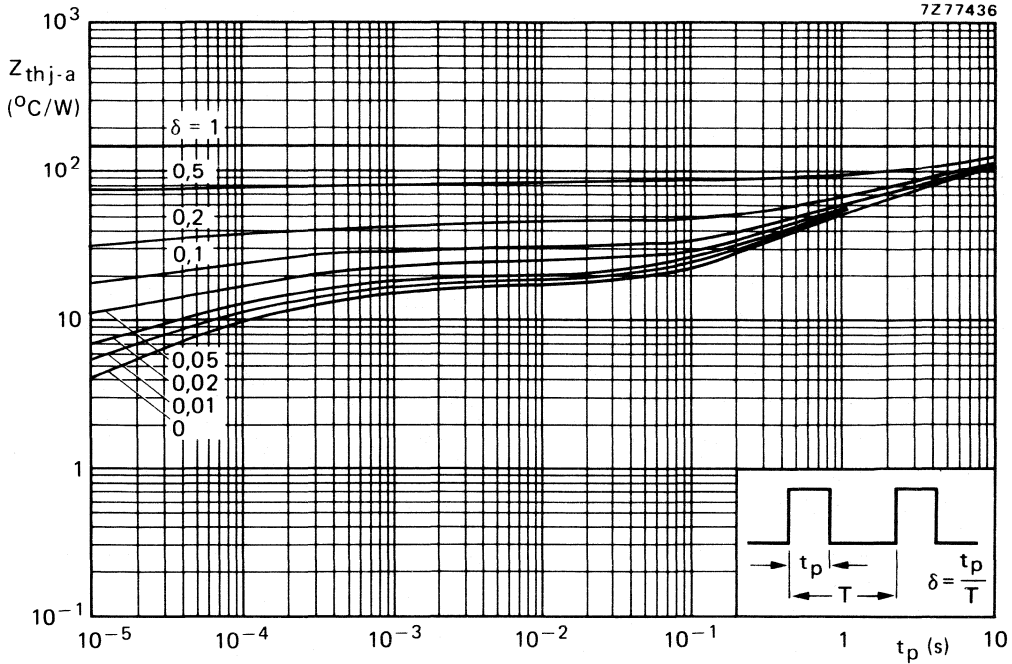

Fig. 2 Thermal impedance from junction to ambient versus pulse duration. Maximum lead length 4 mm; mounting pad for collector lead minimum 10 mm x 10 mm.

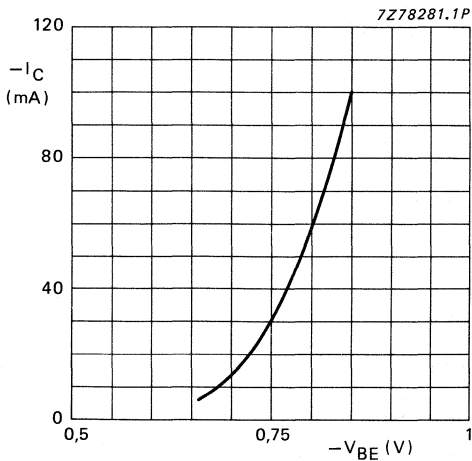

Fig. 3  $-V_{CE} = 20 \text{ V}$ ;  $T_j = 25 \text{ }^\circ\text{C}$ .

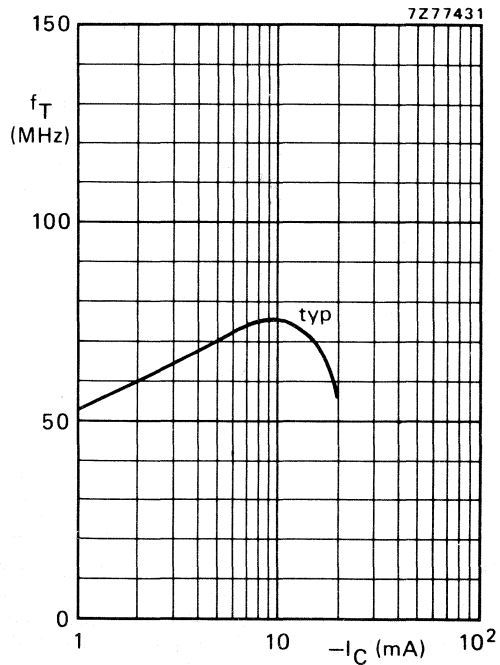

Fig. 4  $-V_{CE} = 10 \text{ V}$ ;  $T_j = 25 \text{ }^\circ\text{C}$ ;  $f = 35 \text{ MHz}$ .

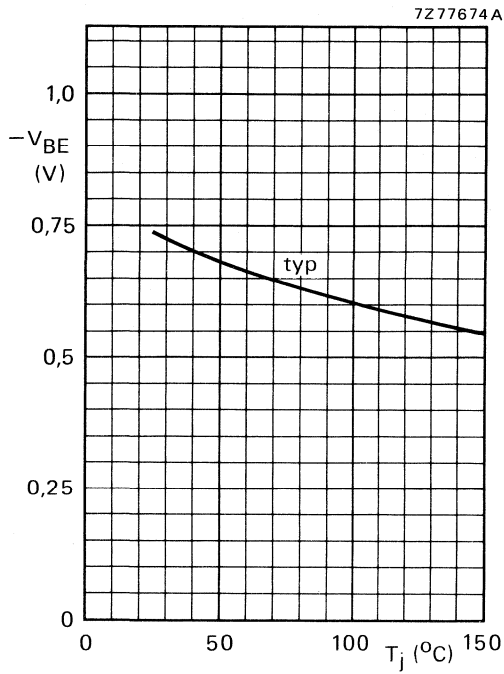

Fig. 5  $-I_C = 25$  mA;  $-V_{CE} = 20$  V.

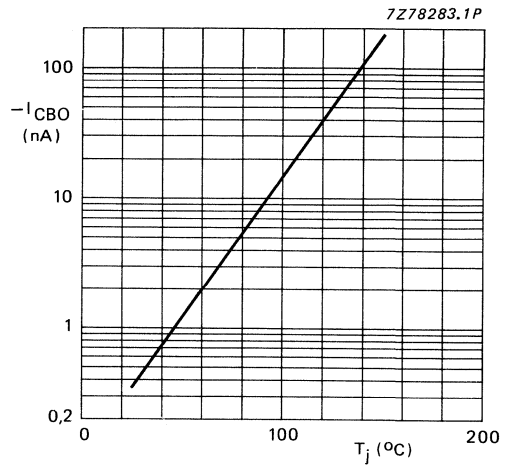

Fig. 6  $-V_{CB} = 200$  V; typical values.

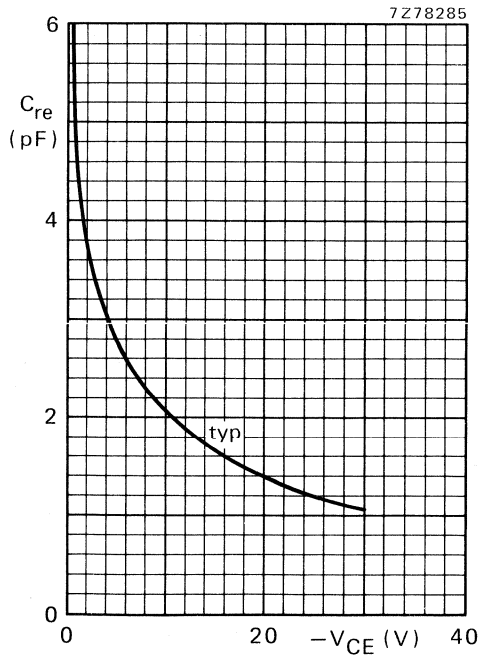

Fig. 7  $I_C = 0$ ;  $f = 1$  MHz;  $T_j = 25$  °C.



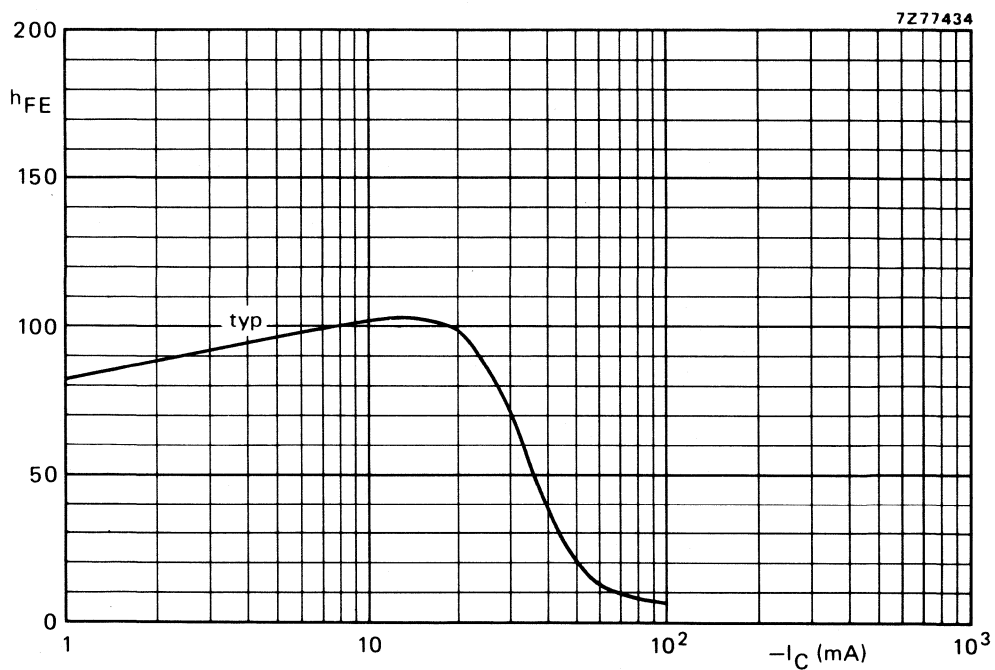

Fig. 8 Typical values at  $-V_{CE} = 20\text{ V}$ ;  $T_j = 25\text{ }^\circ\text{C}$ .





## HF SILICON PLANAR EPITAXIAL TRANSISTORS

PNP transistors in a plastic envelope intended for HF and IF applications in radio receivers, especially for mixer stages in AM receivers and IF stages in AM/FM receivers with negative earth.

### QUICK REFERENCE DATA

Collector-base voltage (open emitter)		$-V_{CBO}$	max.	40 V
Collector-emitter voltage (open base)		$-V_{CEO}$	max.	40 V
Collector current (DC)		$-I_C$	max.	25 mA
Total power dissipation up to $T_{amb} = 25\text{ }^\circ\text{C}$		$P_{tot}$	max.	300 mW
Junction temperature		$T_j$	max.	150 $^\circ\text{C}$
DC current gain	BF450:	$h_{FE}$		62 to 200
$-I_C = 1\text{ mA}; -V_{CE} = 10\text{ V}$	BF451:	$h_{FE}$		30 to 90
Transition frequency		$f_T$	min.	350 MHz
$-I_C = 1\text{ mA}; -V_{CE} = 10\text{ V}$				

### MECHANICAL DATA

Dimensions in mm

Fig. 1 TO-92.

#### Pinning:

- 1 = base
- 2 = emitter
- 3 = collector

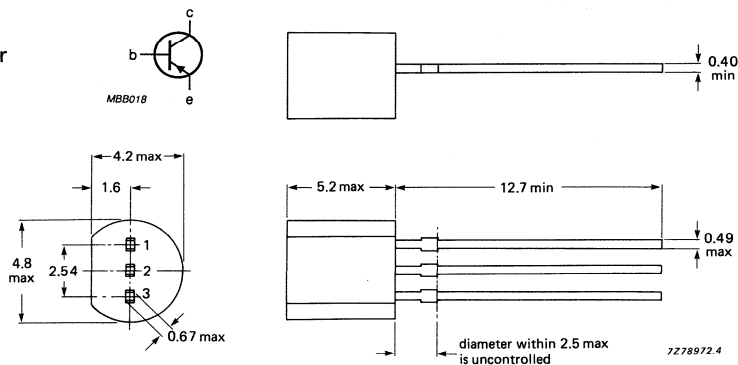

**RATINGS**

Limiting values in accordance with the Absolute Maximum System (IEC 134)

Collector-base voltage (open emitter)	$-V_{CBO}$	max.	40 V
Collector-emitter voltage (open base)	$-V_{CEO}$	max.	40 V
Emitter-base voltage (open collector)	$-V_{EBO}$	max.	4 V
Collector current (DC)	$-I_C$	max.	25 mA
Total power dissipation up to $T_{amb} = 25\text{ }^\circ\text{C}$	$P_{tot}$	max.	300 mW
Storage temperature range	$T_{stg}$		-65 to +150 $^\circ\text{C}$
Junction temperature	$T_j$	max.	150 $^\circ\text{C}$

**THERMAL RESISTANCE**

From junction to ambient in free air	$R_{th\ j-a}$	=	420 K/W
--------------------------------------	---------------	---	---------

**CHARACTERISTICS**

$T_{amb} = 25\text{ }^\circ\text{C}$  unless otherwise stated

Collector cut-off current

$I_E = 0; -V_{CB} = 30\text{ V}$

$-I_{CBO}$	max.	50 nA
------------	------	-------

$I_E = 0; -V_{CB} = 30\text{ V}; T_{amb} = 150\text{ }^\circ\text{C}$

$-I_{CBO}$	max.	4 $\mu\text{A}$
------------	------	-----------------

Emitter-cut-off current

$I_C = 0; -V_{EB} = 3\text{ V}$

$-I_{EBO}$	max.	100 nA
------------	------	--------

DC current gain

$-I_C = 1\text{ mA}; -V_{CE} = 10\text{ V}$

BF450

$h_{FE}$		62 to 200 $\mu\text{A}$
----------	--	-------------------------

BF451

$h_{FE}$		30 to 90 $\mu\text{A}$
----------	--	------------------------

Base-emitter voltage

$-I_C = 1\text{ mA}; -V_{CE} = 10\text{ V}$

$-V_{BE}$		680 to 780 mV
-----------	--	---------------

Transition frequency at  $f = 100\text{ MHz}$

$-I_C = 1\text{ mA}; -V_{CE} = 10\text{ V}$

$f_T$	min.	350 MHz
-------	------	---------

Feedback capacitance at  $f = 1\text{ MHz}$

$-I_C = 1\text{ mA}; -V_{CE} = 10\text{ V}$

$C_{re}$	max.	0.43 pF
----------	------	---------



## SILICON PLANAR EPITAXIAL TRANSISTORS

N-P-N transistors in TO-92 envelope and intended for use in video output stages in black-and-white and in colour television receivers.

### QUICK REFERENCE DATA

			BF483	BF485	BF487
Collector-base voltage (open emitter)	$V_{CBO}$	max.	300	350	400 V
Collector-emitter voltage (open base)	$V_{CEO}$	max.	250	300	350 V
Collector current (peak value)	$I_{CM}$	max.		100	mA
Total power dissipation (free air)	$P_{tot}$	max.		830	mW
D.C. current gain $I_C = 25 \text{ mA}; V_{CE} = 20 \text{ V}$	$h_{FE}$	$\geq$		50	
Transition frequency $-I_E = 10 \text{ mA}; V_{CB} = 10 \text{ V}$	$f_T$		70 to 110		MHz
Junction temperature	$T_j$	max.		150	$^{\circ}\text{C}$

### MECHANICAL DATA

Dimensions in mm

Fig. 1 TO-92.

#### Pinning:

- 1 = base
- 2 = collector
- 3 = emitter

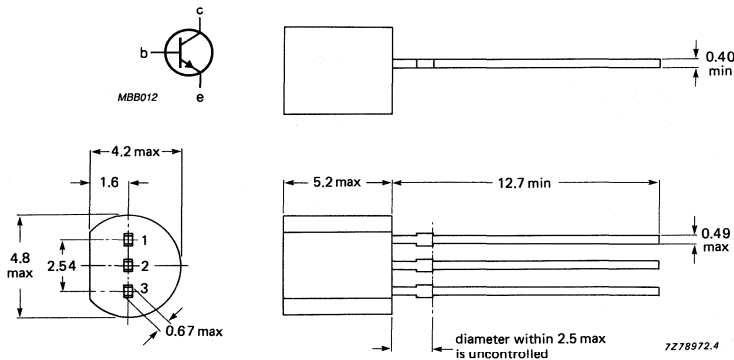

## RATINGS

Limiting values in accordance with the Absolute Maximum System (IEC 134)

		BF483	BF485	BF487
Collector-base voltage (open emitter)	$V_{CBO}$ max.	300	350	400 V
Collector-emitter voltage (open base)	$V_{CEO}$ max.	250	300	350 V
Emitter-base voltage (open collector)	$V_{EBO}$ max.	5		V
Collector current				
d.c.	$I_C$ max.		50	mA
peak value	$I_{CM}$ max.		100	mA
Total power dissipation in free air up to $T_{amb} = 25\text{ }^\circ\text{C}$	$P_{tot}$ max.		830	mW
Storage temperature	$T_{stg}$	-65 to + 150		$^\circ\text{C}$
Junction temperature	$T_j$ max.		150	$^\circ\text{C}$

## THERMAL RESISTANCE

From junction to ambient when mounted  
on a p.c. board and mounting pad for  
collector lead minimum 10 mm x 10 mm  
and maximum lead length 4 mm

$R_{th\ j-a}$ max.	150	K/W
--------------------	-----	-----

## CHARACTERISTICS

$T_j = 25\text{ }^\circ\text{C}$  unless otherwise specified

Collector cut-off current

$I_E = 0; V_{CB} = 300\text{ V}$

$I_{CBO} \leq$	20	nA
----------------	----	----

Collector-emitter cut-off current

$V_{CE} = 250\text{ V}; R_{BE} = 2,7\text{ k}\Omega;$

$T_j = 150\text{ }^\circ\text{C}$

$I_{CER} \leq$	20	$\mu\text{A}$
----------------	----	---------------

Emitter cut-off current

$I_C = 0; V_{EB} = 5\text{ V}$

$I_{EBO} \leq$	10	$\mu\text{A}$
----------------	----	---------------

High-frequency knee voltage

$I_C = 25\text{ mA}; T_j = 150\text{ }^\circ\text{C}$

$V_{CEK} \leq$	20	V
----------------	----	---

D.C. current gain

$I_C = 25\text{ mA}; V_{CE} = 20\text{ V}$

$I_C = 40\text{ mA}; V_{CE} = 20\text{ V}$

$h_{FE} \geq$	50	
$\geq$	20	

Transition frequency

$-I_E = 10\text{ mA}; V_{CB} = 10\text{ V}$

$f_T$	70 to 110	MHz
-------	-----------	-----

Feedback capacitance at  $f = 1\text{ MHz}$

$I_E = 0; V_{CB} = 30\text{ V}$

$C_{re} \leq$	1,4	pF
---------------	-----	----

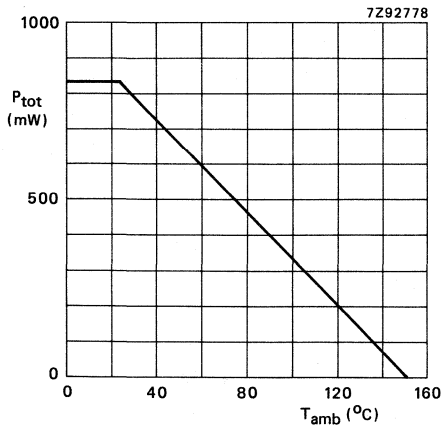

Fig. 2 Maximum permissible power dissipation.

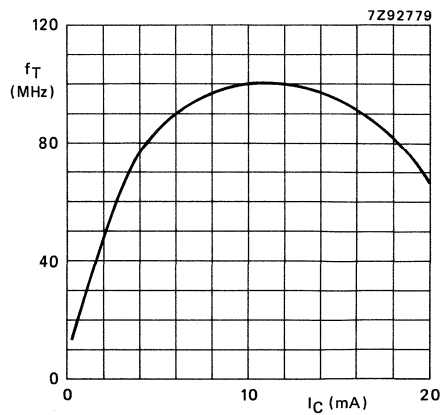

Fig. 3  $V_{CE} = 10$  V;  $f = 100$  MHz; typical values.

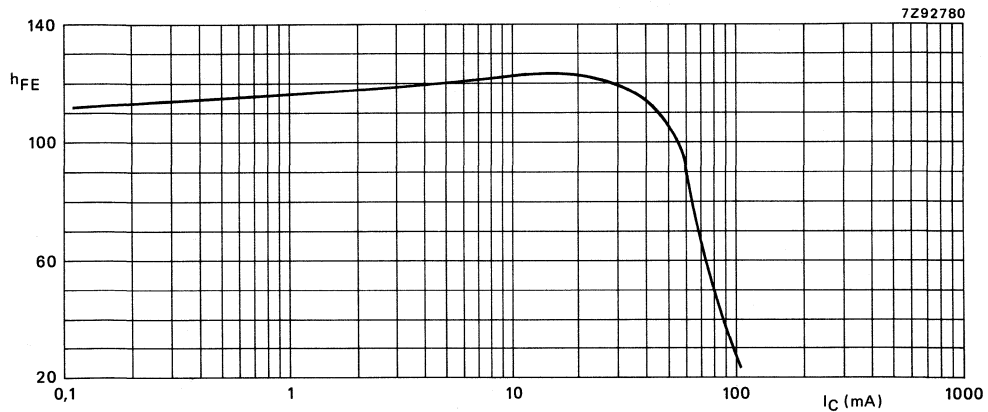

Fig. 4  $T_j = 25$   $^{\circ}C$ ;  $V_{CE} = 20$  V; typical values.

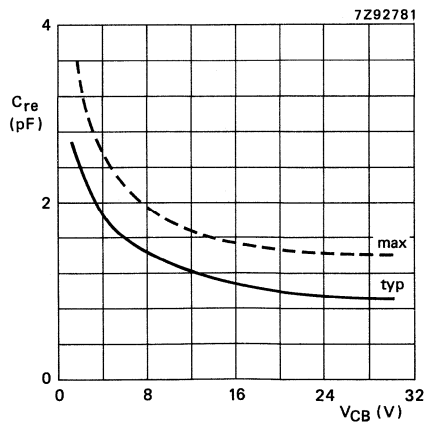

Fig. 5  $I_E = 0$ ;  $f = 1$  MHz.

# THE UNIVERSITY OF CHICAGO

THE UNIVERSITY OF CHICAGO  
DIVISION OF THE PHYSICAL SCIENCES  
DEPARTMENT OF CHEMISTRY

CHICAGO, ILLINOIS

THE UNIVERSITY OF CHICAGO  
DIVISION OF THE PHYSICAL SCIENCES  
DEPARTMENT OF CHEMISTRY  
5708 SOUTH CAMPUS DRIVE  
CHICAGO, ILLINOIS 60637

\*\*\*





## SILICON PLANAR EPITAXIAL TRANSISTORS

PNP transistors in a TO-92 envelope and intended for use in video output stages of black and white and colour television receivers.

### QUICK REFERENCE DATA

			BF484	BF486	BF488
Collector-base voltage (open emitter)	$-V_{CBO}$	max.	250	300	350 V
Collector-emitter voltage (open base)	$-V_{CEO}$	max.	250	300	350 V
Collector current (peak value)	$-I_{CM}$	max.		100	mA
Total power dissipation (free air)	$P_{tot}$	max.		830	mW
DC current gain $-I_C = 25 \text{ mA}; -V_{CE} = 20 \text{ V}$	$h_{FE}$	min.		50	
Transition frequency $-I_C = 10 \text{ mA}; -V_{CE} = 10 \text{ V}$	$f_T$			70 to 110	MHz
Junction temperature	$T_j$	max.		150	$^{\circ}\text{C}$

### MECHANICAL DATA

Dimensions in mm

Fig.1 TO-92.

#### Pinning:

1. Base
2. Collector
3. Emitter

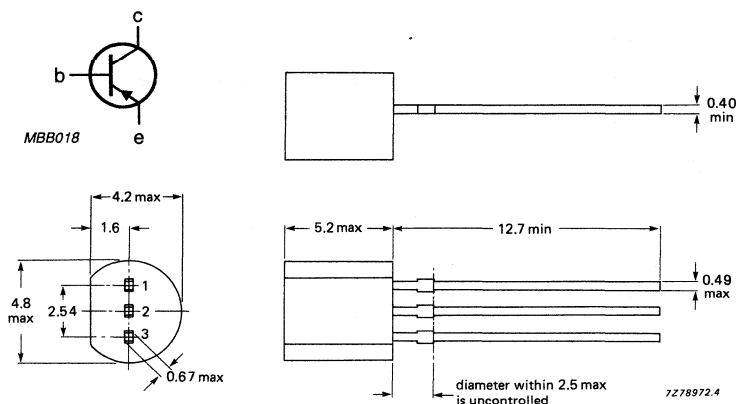

## RATINGS

Limiting values in accordance with the Absolute Maximum System (IEC 134)

			BF484	BF486	BF488
Collector-base voltage (open emitter)	$-V_{CBO}$	max.	250	300	350 V
Collector-emitter voltage (open base)	$-V_{CEO}$	max.	250	300	350 V
Emitter-base voltage (open collector)	$-V_{EBO}$	max.		5	V
Collector current					
DC	$-I_C$	max.		100	mA
peak value	$-I_{CM}$	max.		100	mA
Total power dissipation in free air up to $T_{amb} = 25\text{ }^\circ\text{C}$	$P_{tot}$	max.		830	mW
Storage temperature range	$T_{stg}$			-65 to 150	$^\circ\text{C}$
Junction temperature	$T_j$			150	$^\circ\text{C}$

## THERMAL RESISTANCE

From junction to ambient when mounted  
on a printed-circuit board and  
mounting pad for collector lead  
minimum 10 mm x 10 mm and  
maximum lead length 4 mm

$R_{th\ j-a}$	max.		150	$^\circ\text{C}$
---------------	------	--	-----	------------------

## CHARACTERISTICS

$T_j = 25\text{ }^\circ\text{C}$  unless otherwise stated

			BF484	BF486	BF488
Collector-emitter breakdown voltage $-I_C = 2.5\text{ mA}; I_B = 0$	$-V_{(BR)CEO}$	max.	250	300	350 V
Collector-base breakdown voltage $-I_C = 10\text{ }\mu\text{A}; I_E = 0$	$-V_{(BR)CBO}$	max.	250	300	350 V
Emitter-base breakdown voltage $-I_E = 100\text{ }\mu\text{A}; I_C = 0$	$-V_{(BR)EBO}$	max.	5	5	5 V
Collector cut-off current $I_E = 0; -V_{CB} = 200\text{ V}$	$-I_{CBO}$	max.	20		nA
$I_E = 0; -V_{CB} = 250\text{ V}$	$-I_{CBO}$	max.		20	nA
$I_E = 0; -V_{CB} = 300\text{ V}$	$-I_{CBO}$	max.			20 nA
Collector-emitter cut-off current $-V_{CE} = 200\text{ V}; R_{BE} = 2.7\text{ k}\Omega;$ $T_j = 150\text{ }^\circ\text{C}$	$-I_{CER}$	max.		20	$\mu\text{A}$
High frequency knee voltage $-I_C = 25\text{ mA}; T_j = 150\text{ }^\circ\text{C}$	$-V_{CEK}$	max.		15	V
DC current gain $-I_C = 25\text{ mA}; -V_{CE} = 20\text{ V}$	hFE	min.		50	
$-I_C = 40\text{ mA}; -V_{CE} = 20\text{ V}$	hFE	min.		20	

Saturation voltages				
$-I_C = 20 \text{ mA}; -I_B = 2 \text{ mA}$	$-V_{CEsat}$	max.	0.5	V
	$-V_{BEsat}$	max.	0.9	V
Transition frequency at $f = 100 \text{ MHz}$				
$-I_C = 10 \text{ mA}; -V_{CE} = 10 \text{ V}$	$f_T$		70 to 110	MHz
Feedback capacitance at $f = 1 \text{ MHz}$				
$I_E = 0; -V_{CB} = 30 \text{ V}$	$C_{re}$	max.	1.6	pF
Output capacitance at $f = 1 \text{ MHz}$				
$I_E = 0; -V_{CB} = 20 \text{ V}$	$C_{ob}$	max.	2.5	pF





## SILICON PLANAR EPITAXIAL TRANSISTOR

NPN transistor in a plastic TO-92 envelope intended for HF applications in radio and television receivers; it is especially recommended for FM tuners, low noise AM mixer-oscillators with high source impedance and IF amplifiers in AM/FM receivers where a high current gain is of importance.

### QUICK REFERENCE DATA

Collector-base voltage (open emitter)	$V_{CBO}$	max.	30 V
Collector-emitter voltage (open base)	$V_{CEO}$	max.	20 V
Collector current (DC)	$I_C$	max.	30 mA
Total power dissipation up to $T_{amb} = 25\text{ }^\circ\text{C}$	$P_{tot}$	max.	300 mW
Junction temperature	$T_j$	max.	150 $^\circ\text{C}$
DC current gain $I_C = 1\text{ mA}; V_{CE} = 10\text{ V}$	$h_{FE}$		67 to 220
Transition frequency $I_C = 1\text{ mA}; V_{CE} = 10\text{ V}$	$f_T$	min.	120 MHz

### MECHANICAL DATA

Dimensions in mm

Fig.1 TO-92.

#### Pinning:

- 1 = base
- 2 = emitter
- 3 = collector

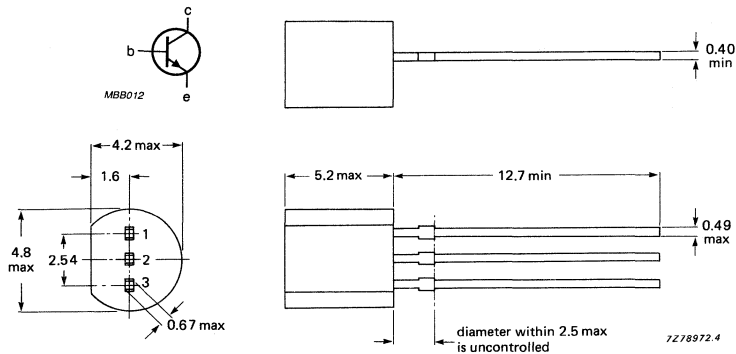

**RATINGS**

Limiting values in accordance with the Absolute Maximum System (IEC 134)

Collector-base voltage (open emitter)	$V_{CBO}$	max.	30 V
Collector-emitter voltage (open base)	$V_{CEO}$	max.	20 V
Emitter-base voltage (open collector)	$V_{EBO}$	max.	5 V
Collector current (DC)	$I_C$	max.	30 mA
Collector current (peak value)	$I_{CM}$	max.	30 mA
Total power dissipation up to $T_{amb} = 25\text{ }^\circ\text{C}$	$P_{tot}$	max.	300 mW
Storage temperature range	$T_{stg}$		-65 to + 150 $^\circ\text{C}$
Junction temperature	$T_j$	max.	150 $^\circ\text{C}$

**THERMAL RESISTANCE**

From junction to ambient in free air	$R_{th\ j-a}$	=	420 K/W
--------------------------------------	---------------	---	---------

**CHARACTERISTICS**

$T_{amb} = 25\text{ }^\circ\text{C}$  unless otherwise specified

Base-emitter voltage

$I_C = 1\text{ mA}; V_{CE} = 10\text{ V}$	$V_{BE}$	0.65 to 0.74 V
---	----------	----------------

DC current gain

$I_C = 1\text{ mA}, V_{CE} = 10\text{ V}$	BF494 $h_{FE}$	67 to 220
	BF494B $h_{FE}$	100 to 220

Feedback capacitance at  $f = 0.45\text{ MHz}$

$I_C = 1\text{ mA}; V_{CE} = 10\text{ V}$	$C_{re}$	max.	1 pF
---	----------	------	------

Transition frequency

$I_C = 1\text{ mA}; V_{CE} = 10\text{ V}$	$f_T$	min.	120 MHz
		typ.	260 MHz

Collector cut-off current

$I_E = 0; V_{CB} = 20\text{ V}$	$I_{CBO}$	max.	100 nA
$I_E = 0; V_{CB} = 20\text{ V}; T_{amb} = 150\text{ }^\circ\text{C}$	$I_{CBO}$	max.	4 $\mu\text{A}$

Emitter-base cut-off current

$I_C = 0; V_{EB} = 4\text{ V}$	$I_{EBO}$	max.	100 nA
--------------------------------	-----------	------	--------



## SILICON PLANAR EPITAXIAL TRANSISTOR

NPN transistor in a plastic TO-92 envelope intended for HF applications in radio and television receivers; it is especially recommended for FM tuners, IF amplifiers in AM/FM receivers where a low transistor output conductance is of importance, AM input stages of car radios where a low noise figure at low source impedance is required.

### QUICK REFERENCE DATA

Collector-base voltage (open emitter)	$V_{CBO}$	max.	30 V
Collector-emitter voltage (open base)	$V_{CEO}$	max.	30 V
Collector current (DC)	$I_C$	max.	30 mA
Total power dissipation up to $T_{amb} = 25\text{ }^\circ\text{C}$	$P_{tot}$	max.	300 mW
Junction temperature	$T_j$	max.	150 $^\circ\text{C}$
DC current gain	$h_{FE}$		35 to 125
Transition frequency	$f_T$	min.	120 MHz
$I_C = 1\text{ mA}; V_{CE} = 10\text{ V}$			
$I_C = 1\text{ mA}; V_{CE} = 10\text{ V}$			

### MECHANICAL DATA

Dimensions in mm

Fig. 1 TO-92.

#### Pinning

- 1 = base
- 2 = emitter
- 3 = collector

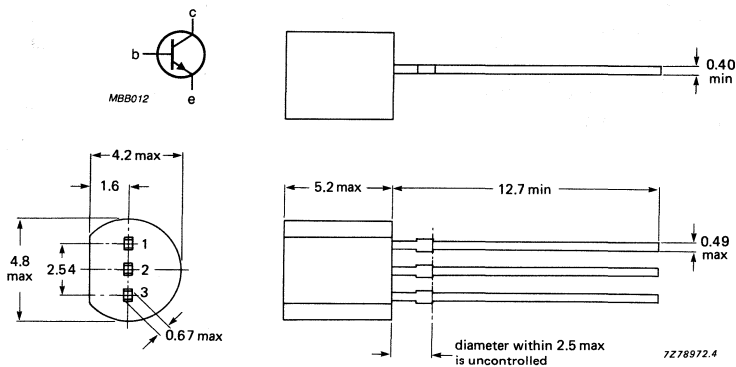

**RATINGS**

Limiting values in accordance with Absolute Maximum System (IEC 134)

Collector-base voltage (open emitter)	$V_{CBO}$	max.	30 V
Collector-emitter voltage (open base)	$V_{CEO}$	max.	20 V
Emitter-base voltage (open collector)	$V_{EBO}$	max.	5 V
Collector current (DC)	$I_C$	max.	30 mA
Collector current (peak value)	$I_{CM}$	max.	30 mA
Total power dissipation up to $T_{amb} = 25\text{ }^\circ\text{C}$	$P_{tot}$	max.	300 mW
Storage temperature range	$T_{stg}$		-65 to +150 $^\circ\text{C}$
Junction temperature	$T_j$	max.	150 $^\circ\text{C}$

**THERMAL RESISTANCE**

From junction to ambient in free air	$R_{th\ j-a}$	=	420 K/W
--------------------------------------	---------------	---	---------

**CHARACTERISTICS**

$T_{amb} = 25\text{ }^\circ\text{C}$  unless otherwise specified

Base-emitter voltage

$I_C = 1\text{ mA}; V_{CE} = 10\text{ V}$	$V_{BE}$	0.65 to 0.74 V
---	----------	----------------

DC current gain

$I_C = 1\text{ mA}; V_{CE} = 10\text{ V}$	BF495	$h_{FE}$	35 to 125
	BF495C	$h_{FE}$	67 to 125

Feedback capacitance at  $f = 0.45\text{ MHz}$

$I_C = 1\text{ mA}; V_{CE} = 10\text{ V}$	$C_{re}$	max.	1 pF
---	----------	------	------

Transition frequency

$I_C = 1\text{ mA}; V_{CE} = 10\text{ V}$	$f_T$	min.	120 MHz
---	-------	------	---------

Collector cut-off current

$I_E = 0; V_{CB} = 20\text{ V}$	$I_{CBO}$	max.	100 nA
---------------------------------	-----------	------	--------

$I_E = 0; V_{CB} = 20\text{ V}; T_{amb} = 150\text{ }^\circ\text{C}$	$I_{CBO}$	max.	4 $\mu\text{A}$
--	-----------	------	-----------------

Emitter-base cut-off current

$I_C = 0; V_{EB} = 4\text{ V}$	$I_{EBO}$	max.	100 nA
--------------------------------	-----------	------	--------



SUPERSEDES DATA OF JULY 1987

## SILICON PLANAR TRANSISTOR

NPN transistor in a plastic TO-92 envelope intended for VHF applications, e.g. as gain controlled pre-amplifier in VHF television and FM tuners.

### QUICK REFERENCE DATA

Collector-base voltage (open emitter)	$V_{CBO}$	max.	30 V
Collector-emitter voltage (open base)	$V_{CEO}$	max.	20 V
Collector current (DC)	$I_C$	max.	20 mA
Total power dissipation up to $T_{amb} = 75^\circ\text{C}$	$P_{tot}$	max.	300 mW
Junction temperature	$T_j$	max.	150 $^\circ\text{C}$
Transition frequency $-I_E = 2\text{ mA}; V_{CB} = 10\text{ V}$	$f_T$	min.	300 MHz

### MECHANICAL DATA

Dimensions in mm

Fig.1 TO-92.

#### Pinning

- 1 = emitter
- 2 = base
- 3 = collector

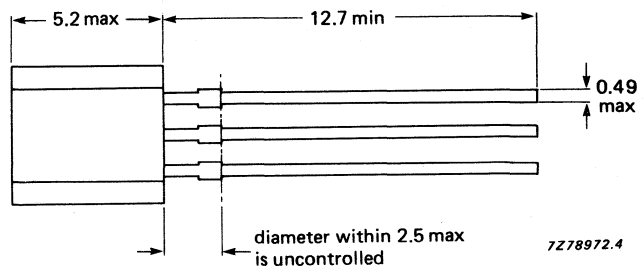
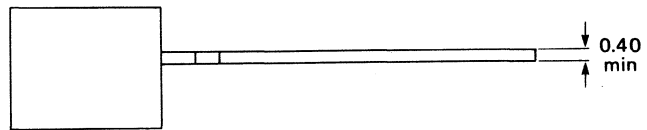
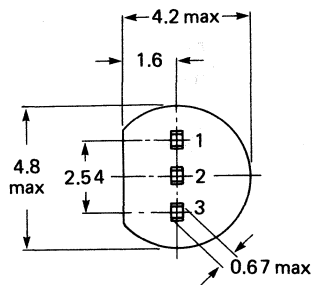
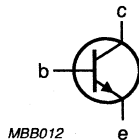

**RATINGS**

Limiting values in accordance with the Absolute Maximum System (IEC 134)

Collector-base voltage (open emitter)	$V_{CBO}$	max.	30 V
Collector-emitter voltage (open base)	$V_{CEO}$	max.	20 V
Collector-emitter voltage ( $R_{BE} \leq 1 \text{ k}\Omega$ )	$V_{CER}$	max.	30 V
Emitter-base voltage (open collector)	$V_{EBO}$	max.	3 V
Collector current (DC)	$I_C$	max.	20 mA
Collector current (peak value)	$I_{CM}$	max.	20 mA
Total power dissipation up to $T_{amb} = 75 \text{ }^\circ\text{C}$	$P_{tot}$	max.	300 mW
Storage temperature range	$T_{stg}$		-65 to + 150 $^\circ\text{C}$
Junction temperature	$T_j$	max.	150 $^\circ\text{C}$

**THERMAL RESISTANCE**

From junction to ambient in free air	$R_{th\ j-a}$	=	420 K/W
--------------------------------------	---------------	---	---------

**CHARACTERISTICS** $T_{amb} = 25 \text{ }^\circ\text{C}$  unless otherwise specified

DC current gain

$-I_E = 2 \text{ mA}; V_{CB} = 10 \text{ V}$	$h_{FE}$	min.	13
--	----------	------	----

$-I_E = 12 \text{ mA}; V_{CB} = 7 \text{ V}^*$	$h_{FE}$	min.	5
--	----------	------	---

Emitter-base voltage

$-I_E = 2 \text{ mA}; V_{CB} = 10 \text{ V}$	$-V_{EB}$	max.	0.9 V
--	-----------	------	-------

$-I_E = 12 \text{ mA}; V_{CB} = 7 \text{ V}^*$	$-V_{EB}$	max.	1.0 V
--	-----------	------	-------

Transition frequency

$-I_E = 2 \text{ mA}; V_{CB} = 10 \text{ V}$	$f_T$	300 to 800 MHz
--	-------	----------------

$-I_E = 4 \text{ mA}; V_{CB} = 5 \text{ V}$	$f_T$	max. 530 MHz
---	-------	--------------

Feedback capacitance at  $f = 10.7 \text{ MHz}$ 

$I_C = 1 \text{ mA}; V_{CE} = 10 \text{ V}$	$C_{re}$	typ.	0.8 pF
		max.	1.0 pF

Collector cut-off current

$I_E = 0; V_{CB} = 20 \text{ V}$	$I_{CBO}$	max.	500 nA
----------------------------------	-----------	------	--------

$I_E = 0; V_{CB} = 20 \text{ V}; T_{amb} = 150 \text{ }^\circ\text{C}$	$I_{CBO}$	max.	10 $\mu\text{A}$
--	-----------	------	------------------

Emitter-base cut-off current

$I_C = 0; V_{EB} = 2 \text{ V}$	$I_{EBO}$	max.	500 nA
---------------------------------	-----------	------	--------

\* Measured under pulsed conditions;  $t_p = 300 \text{ } \mu\text{s}$ ;  $\delta \leq 0.02$ .

y-parameters at  $f = 100$  MHz (common base)

$I_C = 2 \text{ mA}; V_{CE} = 10 \text{ V}$

Input conductance	$g_{ib}$	typ.	66 mS
Input susceptance	$-b_{ib}$	typ.	15 mS
Feedback admittance	$ Y_{rb} $	typ.	190 mS
Phase angle of feedback admittance	$\varphi_{rb}$	typ.	$280^\circ$
Transfer admittance	$ Y_{fb} $	typ.	66 mS
Phase angle of transfer admittance	$\varphi_{fb}$	typ.	$155^\circ$
Output conductance	$g_{ob}$	typ.	15 $\mu$ S
Output susceptance	$b_{ob}$	typ.	660 $\mu$ S

y-parameters at  $f = 50$  MHz (common base)

$-I_E = 3 \text{ mA}; V_{CB} = 10 \text{ V}$

Input conductance	$g_{ib}$	typ.	9.5 mS
Input susceptance	$-b_{ib}$	typ.	12 mS
Feedback admittance	$ Y_{rb} $	typ.	100 $\mu$ S
Phase angle of feedback admittance	$\varphi_{rb}$	typ.	$270^\circ$
Transfer admittance	$ Y_{fb} $	typ.	95 mS
Phase angle of transfer admittance	$\varphi_{fb}$	typ.	$160^\circ$
Output conductance	$g_{ob}$	typ.	10 $\mu$ S
Output susceptance	$b_{ob}$	typ.	350 $\mu$ S

y-parameters at  $f = 200$  MHz (common base)

$-I_E = 3 \text{ mA}; V_{CB} = 10 \text{ V}$

Input conductance	$g_{ib}$	typ.	70 mS
Input susceptance	$-b_{ib}$	typ.	46 mS
Feedback admittance	$ Y_{rb} $	typ.	340 $\mu$ S
Phase angle of feedback admittance	$\varphi_{rb}$	typ.	$275^\circ$
Transfer admittance	$ Y_{fb} $	typ.	85 mS
Phase angle of transfer admittance	$\varphi_{fb}$	typ.	$130^\circ$
Output conductance	$g_{ob}$	typ.	75 $\mu$ S
Output susceptance	$b_{ob}$	typ.	1.3 mS





## SILICON PLANAR EPITAXIAL TRANSISTOR

P-N-P transistor in a TO-92 envelope intended for use as preamplifier, mixer and oscillator in v.h.f. and u.h.f. tuners.

### QUICK REFERENCE DATA

Collector-base voltage (open emitter)	$-V_{CBO}$	max.	30 V
Collector-emitter voltage (open base)	$-V_{CEO}$	max.	20 V
Collector current (d.c.)	$-I_C$	max.	25 mA
Total power dissipation up to $T_{amb} = 45\text{ }^\circ\text{C}$	$P_{tot}$	max.	250 mW
Junction temperature	$T_j$	max.	150 $^\circ\text{C}$
Transition frequency at $f = 100\text{ MHz}$ $I_E = 1\text{ mA}; -V_{CB} = 10\text{ V}$	$f_T$	typ.	350 MHz
Noise figure at $f = 200\text{ MHz}$ $I_E = 1\text{ mA}; -V_{CB} = 10\text{ V}$	F	<	6 dB
Transducer gain (common base) $I_E = 3\text{ mA}; -V_{CB} = 10\text{ V}$	$G_{tr}$	>	14 dB

### MECHANICAL DATA

Dimensions in mm

Fig. 1 TO-92.

#### Pinning

- 1 = base
- 2 = emitter
- 3 = collector

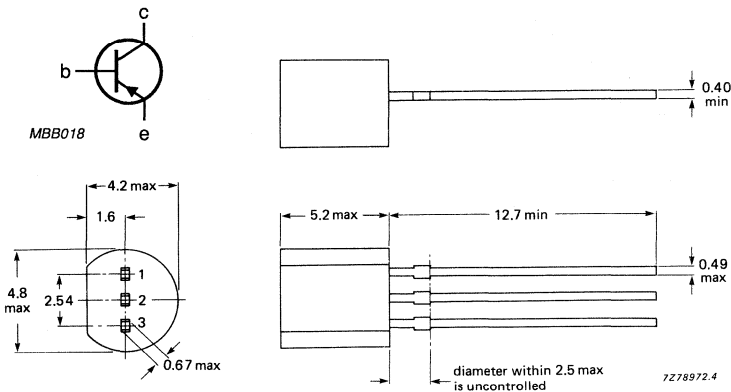

**RATINGS**

Limiting values in accordance with the Absolute Maximum System (IEC 134)

Collector-base voltage (open emitter)	$-V_{CBO}$	max.	30 V
Collector-emitter voltage (open base)	$-V_{CEO}$	max.	20 V
Emitter-base voltage (open collector)	$-V_{EBO}$	max.	4 V
Collector current (d.c.)	$-I_C$	max.	25 mA
Total power dissipation up to $T_{amb} = 45\text{ }^\circ\text{C}$	$P_{tot}$	max.	250 mW
Storage temperature	$T_{stg}$		$-65$ to $+150\text{ }^\circ\text{C}$
Junction temperature	$T_j$	max.	150 $^\circ\text{C}$

**THERMAL RESISTANCE**

From junction to ambient in free air	$R_{th\ j-a}$	=	420 K/W
--------------------------------------	---------------	---	---------

**CHARACTERISTICS**

$T_{amb} = 25\text{ }^\circ\text{C}$

Collector cut-off current

$I_E = 0; -V_{CB} = 20\text{ V}$	$-I_{CBO}$	<	50 nA
----------------------------------	------------	---	-------

Base current

$I_E = 1\text{ mA}; -V_{CB} = 10\text{ V}$	$-I_B$	<	33 $\mu\text{A}$
--	--------	---	------------------

Collector-base breakdown voltage

open emitter; $-I_C = 10\text{ }\mu\text{A}$	$-V_{(BR)CBO}$	>	30 V
--	----------------	---	------

Collector-emitter breakdown voltage

open base; $-I_C = 2\text{ mA}$	$-V_{(BR)CEO}$	>	20 V
---------------------------------	----------------	---	------

Emitter-base breakdown voltage

open collector; $-I_E = 10\text{ }\mu\text{A}$	$-V_{(BR)EBO}$	>	4 V
--	----------------	---	-----

Transition frequency at  $f = 100\text{ MHz}$

$I_E = 1\text{ mA}; -V_{CB} = 10\text{ V}$	$f_T$	typ.	350 MHz
--	-------	------	---------

$I_E = 5\text{ mA}; -V_{CB} = 10\text{ V}$	$f_T$	typ.	500 MHz 400 to 700 MHz
--	-------	------	---------------------------

Feedback capacitance at  $f = 1\text{ MHz}$

$I_E = 1\text{ mA}; -V_{CB} = 10\text{ V}$	$C_{re}$	typ.	0,5 pF
--	----------	------	--------

Noise figure at  $f = 200\text{ MHz}$

$I_E = 1\text{ mA}; -V_{CB} = 10\text{ V}$	F	typ.	5 dB
		<	6 dB

Transducer gain (common base) at  $f = 200\text{ MHz}$

$I_E = 3\text{ mA}; -V_{CB} = 10\text{ V}; R_S = 60\text{ }\Omega; R_L = 920\text{ }\Omega$	$G_{tr}$	>	14 dB
		typ.	17,5 dB

## SILICON PLANAR EPITAXIAL TRANSISTOR

P-N-P transistor in a plastic T-package intended for application as self-oscillating mixer stage in u.h.f. tuners.

### QUICK REFERENCE DATA

Collector-base voltage (open emitter)	$-V_{CBO}$	max.	40 V
Collector-emitter voltage (open base)	$-V_{CEO}$	max.	35 V
Collector current (d.c.)	$-I_C$	max.	30 mA
Total power dissipation up to $T_{amb} = 55\text{ }^{\circ}\text{C}$	$P_{tot}$	max.	160 mW
Junction temperature	$T_j$	max.	150 $^{\circ}\text{C}$
Transition frequency at $f = 100\text{ MHz}$ $I_E = 3\text{ mA}$ ; $-V_{CB} = 10\text{ V}$	$f_T$	typ.	900 MHz

### MECHANICAL DATA

Dimensions in mm

Fig. 1 SOT-37.

Connections

1. Emitter
2. Base
3. Collector

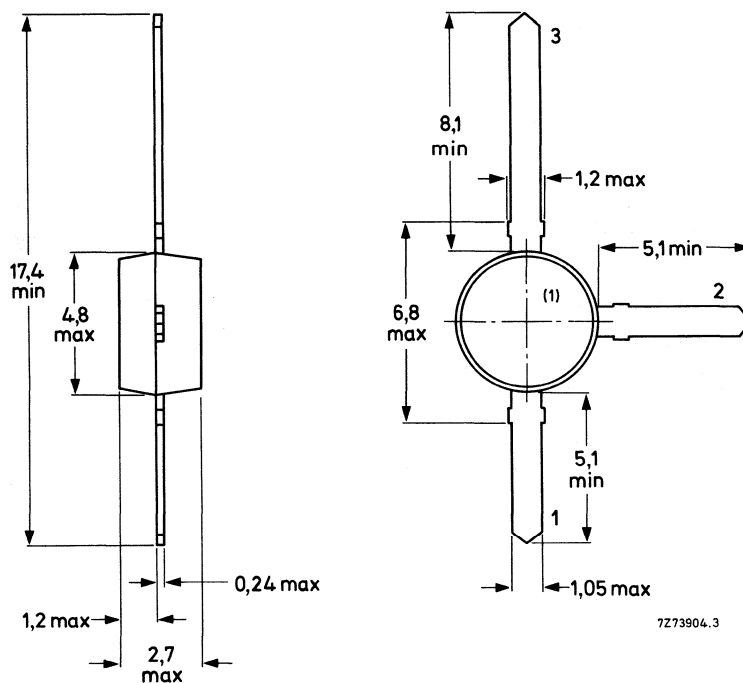

(1) = type number marking.

**RATINGS**

Limiting values in accordance with the Absolute Maximum System (IEC 134)

Collector-base voltage (open emitter)	$-V_{CB0}$	max.	40 V
Collector-emitter voltage (open base)	$-V_{CEO}$	max.	35 V
Emitter-base voltage (open collector)	$-V_{EBO}$	max.	3 V
Collector current (d.c.)	$-I_C$	max.	30 mA
Emitter current (d.c.)	$I_E$	max.	35 mA
Total power dissipation up to $T_{amb} = 55\text{ }^\circ\text{C}$	$P_{tot}$	max.	160 mW
Storage temperature	$T_{stg}$		$-55\text{ to }+150\text{ }^\circ\text{C}$
Junction temperature	$T_j$	max.	150 $^\circ\text{C}$

**THERMAL RESISTANCE**

From junction to ambient in free air	$R_{th\ j-a}$	=	600 K/W
--------------------------------------	---------------	---	---------

**CHARACTERISTICS**

$T_{amb} = 25\text{ }^\circ\text{C}$

Collector cut-off current

$I_E = 0; -V_{CB} = 20\text{ V}$	$-I_{CBO}$	<	100 nA
----------------------------------	------------	---	--------

Emitter cut-off current

$I_C = 0; -V_{EB} = 1\text{ V}$	$-I_{EBO}$	<	100 nA
---------------------------------	------------	---	--------

D.C. current gain

$-I_C = 3\text{ mA}; -V_{CB} = 10\text{ V}$	$h_{FE}$	>	25
		typ.	50

Transition frequency at  $f = 100\text{ MHz}$

$I_E = 3\text{ mA}; -V_{CB} = 10\text{ V}$	$f_T$	typ.	900 MHz
			750 to 1060 MHz

$I_E = 7\text{ mA}; -V_{CB} = 5\text{ V}$	$f_T$	>	400 MHz
		typ.	700 MHz

Feedback capacitance at  $f = 1\text{ MHz}$

$I_E = 0; -V_{CB} = 10\text{ V}$	$C_{rb}$	typ.	110 fF
		<	140 fF

$I_E = 1\text{ mA}; -V_{CB} = 10\text{ V}$	$C_{re}$	typ.	475 fF
--	----------	------	--------

Noise figure at  $R_S = 60\text{ }\Omega$

$I_E = 3\text{ mA}; -V_{CB} = 10\text{ V}; f = 200\text{ MHz}$	F	typ.	2,6 dB
--	---	------	--------

$I_E = 3\text{ mA}; -V_{CB} = 10\text{ V}; f = 800\text{ MHz}$	F	typ.	4,7 dB
		<	6,0 dB

Transducer gain (common base) at  $f = 800\text{ MHz}$

$I_E = 3\text{ mA}; -V_{CB} = 10\text{ V}; R_S = 60\text{ }\Omega; R_L = 500\text{ }\Omega$	$G_{tr}$	>	13,0 dB
		typ.	14,5 dB





## SILICON PLANAR EPITAXIAL TRANSISTOR

N-P-N transistor in a plastic TO-92 envelope primarily intended for use in active probes, frequency multipliers and linear amplifiers.

### QUICK REFERENCE DATA

Collector-base voltage (open emitter)	$V_{CBO}$	max.	40 V
Collector-emitter voltage (open base)	$V_{CEO}$	max.	15 V
Collector current (peak value)	$I_{CM}$	max.	500 mA
Total power dissipation up to $T_{amb} = 25\text{ }^{\circ}\text{C}$	$P_{tot}$	max.	500 mW
D.C. current			
$I_C = 10\text{ mA}; V_{CE} = 1\text{ V}$	$h_{FE}$	>	40
Transition frequency at $f = 100\text{ MHz}$			
$I_C = 10\text{ mA}; V_{CE} = 10\text{ V}$	$f_T$	>	500 MHz

### MECHANICAL DATA

Dimensions in mm

Fig. 1 TO-92.

#### Pinning

- 1 = emitter
- 2 = base
- 3 = collector

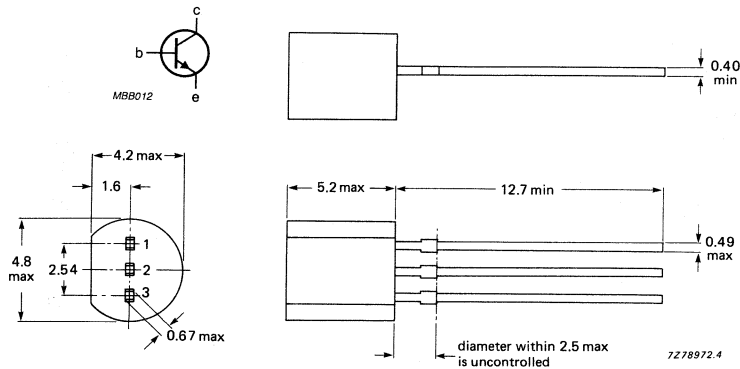

## RATINGS

Limiting values in accordance with the Absolute Maximum System (IEC 134)

Collector-base voltage (open emitter)	$V_{CBO}$	max.	40 V
Collector-emitter voltage ( $V_{BE} = 0$ )	$V_{CES}$	max.	40 V
Collector-emitter voltage (open base)	$V_{CEO}$	max.	15 V
Emitter-base voltage (open collector)	$V_{EBO}$	max.	4,5 V
Collector current (peak value; $t_p = 10 \mu s$ )	$I_{CM}$	max.	500 mA
Total power dissipation up to $T_{amb} = 25 \text{ }^\circ\text{C}$	$P_{tot}$	max.	500 mW
Storage temperature	$T_{stg}$		-65 to + 150 $^\circ\text{C}$
Junction temperature	$T_j$	max.	150 $^\circ\text{C}$

## THERMAL RESISTANCE

From junction to ambient in free air	$R_{th \text{ j-a}}$	=	250 K/W
--------------------------------------	----------------------	---	---------

## CHARACTERISTICS

$T_{amb} = 25 \text{ }^\circ\text{C}$  unless otherwise specified

Collector cut-off current

$$I_E = 0; V_{CB} = 20 \text{ V}$$

$$I_{CBO} < 400 \text{ nA}$$

$$I_E = 0; V_{CB} = 20 \text{ V}; T_j = 125 \text{ }^\circ\text{C}$$

$$I_{CBO} < 30 \text{ } \mu\text{A}$$

Emitter cut-off current

$$I_C = 0; V_{EB} = 2 \text{ V}$$

$$I_{EBO} < 100 \text{ nA}$$

Saturation voltage

$$I_C = 10 \text{ mA}; I_B = 1 \text{ mA}$$

$$V_{CEsat} < 0,25 \text{ V}$$

$$V_{BEsat} < 0,70 \text{ to } 0,85 \text{ V}$$

Knee voltage

$$I_C = 45 \text{ mA}; I_B = \text{value for which}$$

$$I_C = 50 \text{ mA at } V_{CE} = 2 \text{ V}$$

$$V_{CEK} < 0,8 \text{ V}$$

D.C. current gain

$$I_C = 10 \text{ mA}; V_{CE} = 1 \text{ V}$$

$$h_{FE} > 40$$

Transition frequency at  $f = 100 \text{ MHz}$

$$I_C = 10 \text{ mA}; V_{CE} = 10 \text{ V}$$

$$f_T > 500 \text{ MHz}$$

$$I_C = 40 \text{ mA}; V_{CE} = 10 \text{ V}$$

$$f_T > 490 \text{ MHz}$$

Collector capacitance at  $f = 1 \text{ MHz}$

$$I_E = I_e = 0; V_{CB} = 5 \text{ V}$$

$$C_c < 4 \text{ pF}$$

Emitter capacitance at  $f = 1 \text{ MHz}$

$$I_C = I_c = 0; V_{EB} = 1 \text{ V}$$

$$C_e < 4,5 \text{ pF}$$

Maximum unilateral power gain ( $y_{re}$  assumed to be zero)

$$G_{UM} = 10 \log \frac{|y_{fe}|^2}{4g_{ie}g_{oe}}$$

$$I_C = 10 \text{ mA}; V_{CE} = 10 \text{ V}; f = 200 \text{ MHz}$$

$$G_{UM} \text{ typ. } 19 \text{ dB}$$

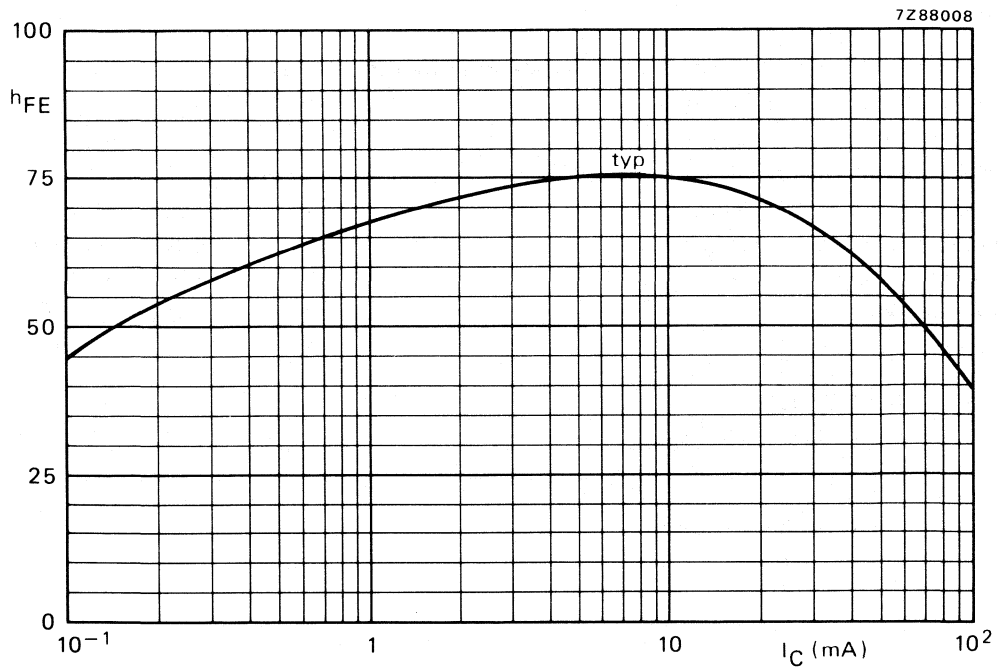

Fig. 2  $V_{CE} = 1\text{ V}; T_j = 25\text{ }^\circ\text{C}.$

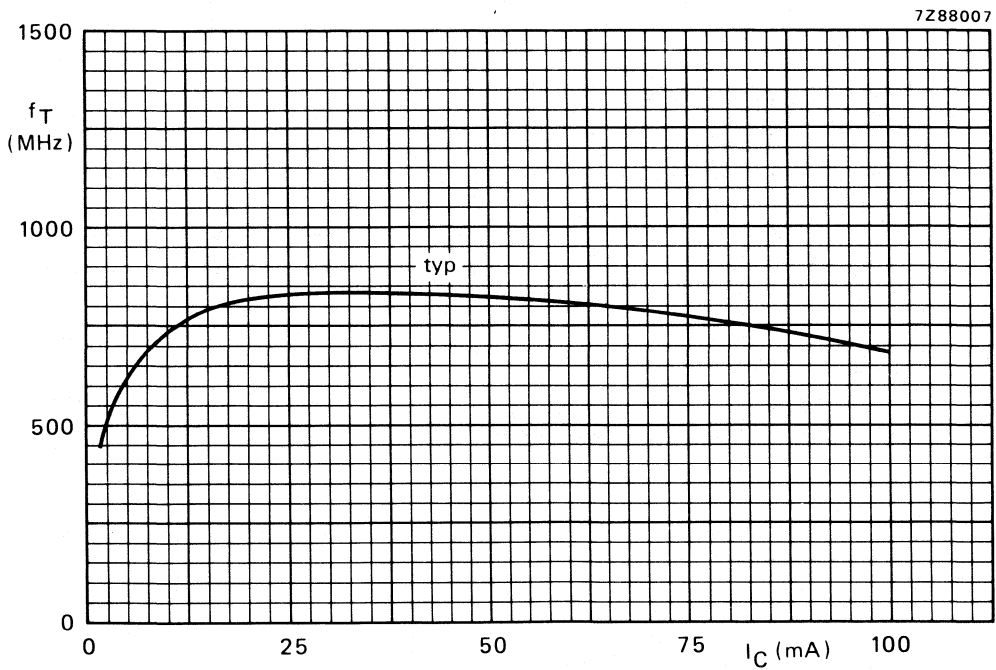

Fig. 3  $V_{CE} = 10\text{ V}; T_j = 25\text{ }^\circ\text{C}.$

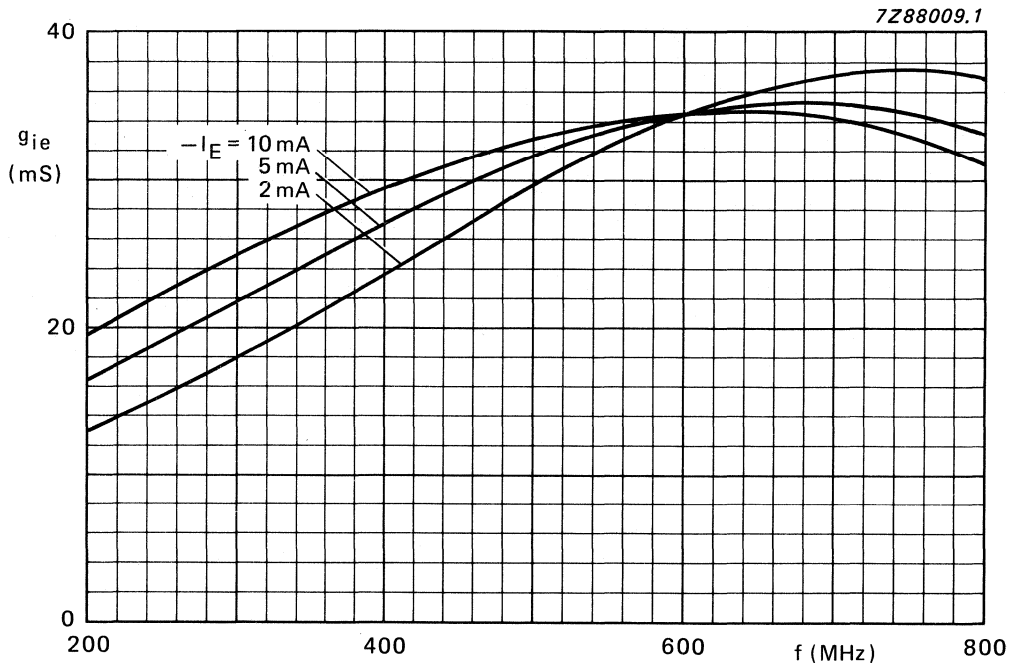

Fig. 4  $V_{CB} = 10\text{ V}$ ;  $T_{amb} = 25\text{ }^\circ\text{C}$ ; typical values.

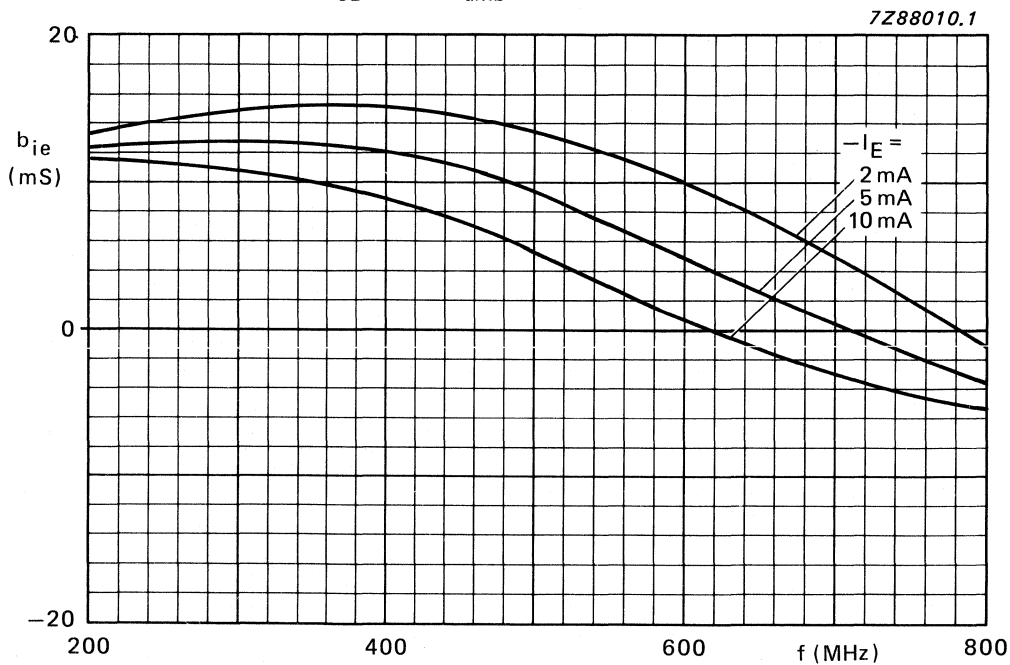

Fig. 5  $V_{CB} = 10\text{ V}$ ;  $T_{amb} = 25\text{ }^\circ\text{C}$ ; typical values.

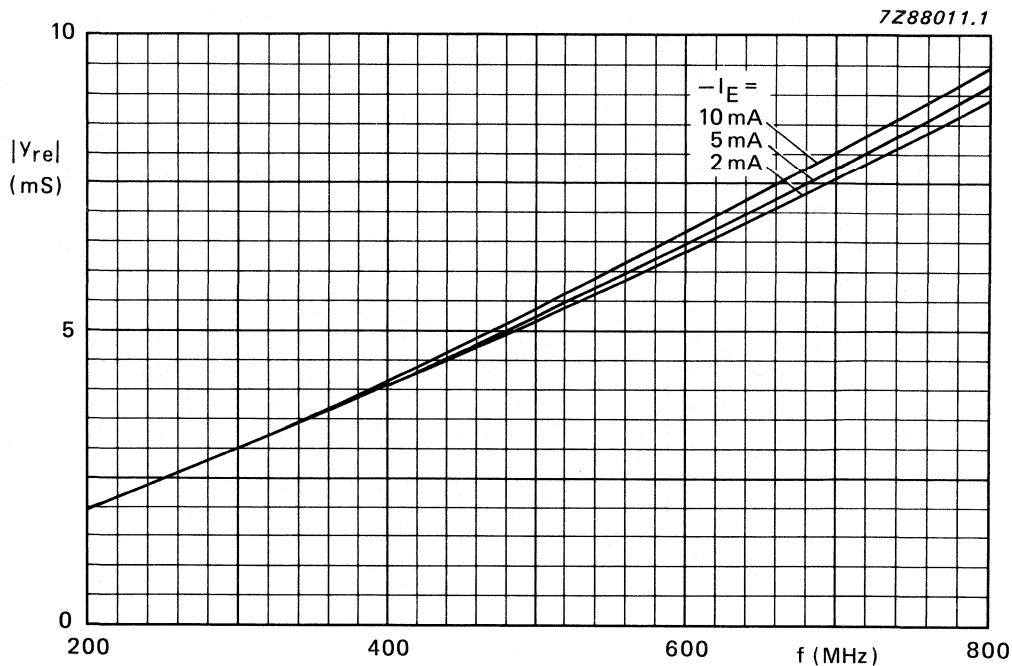

Fig. 6  $V_{CB} = 10\text{ V}$ ;  $T_{amb} = 25\text{ }^\circ\text{C}$ ; typical values.

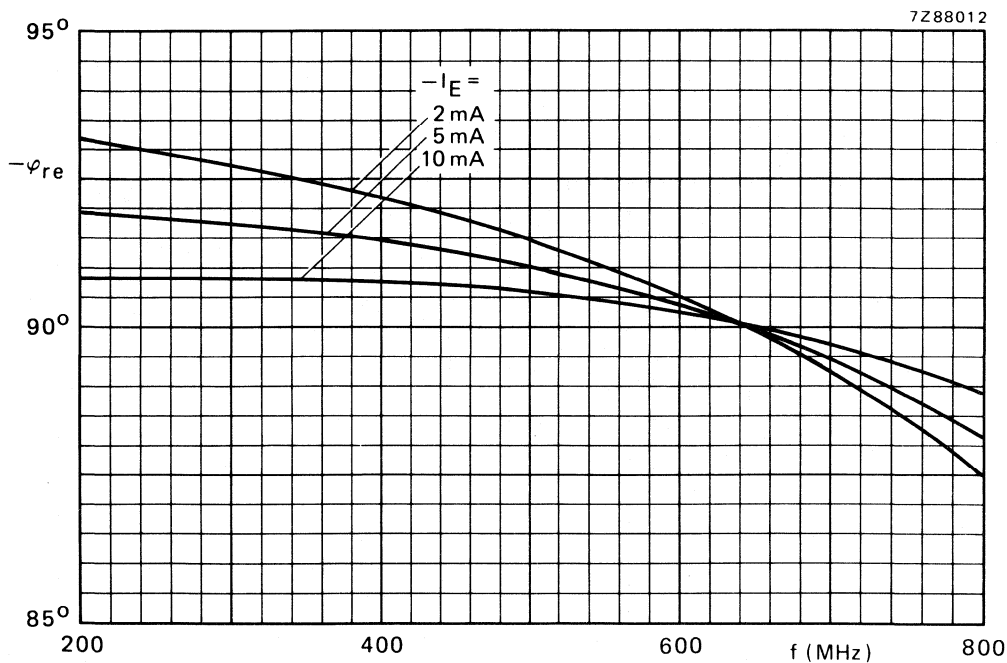

Fig. 7  $V_{CB} = 10\text{ V}$ ;  $T_{amb} = 25\text{ }^\circ\text{C}$ ; typical values.

7Z88015.1

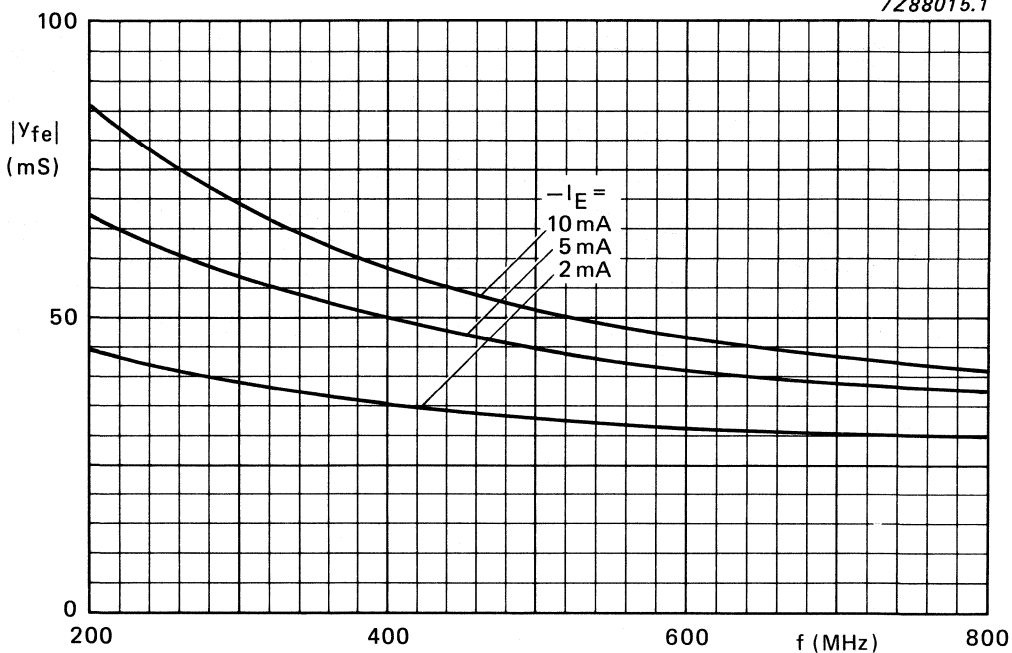

Fig. 8  $V_{CB} = 10$  V;  $T_{amb} = 25$  °C; typical values.

7Z88013

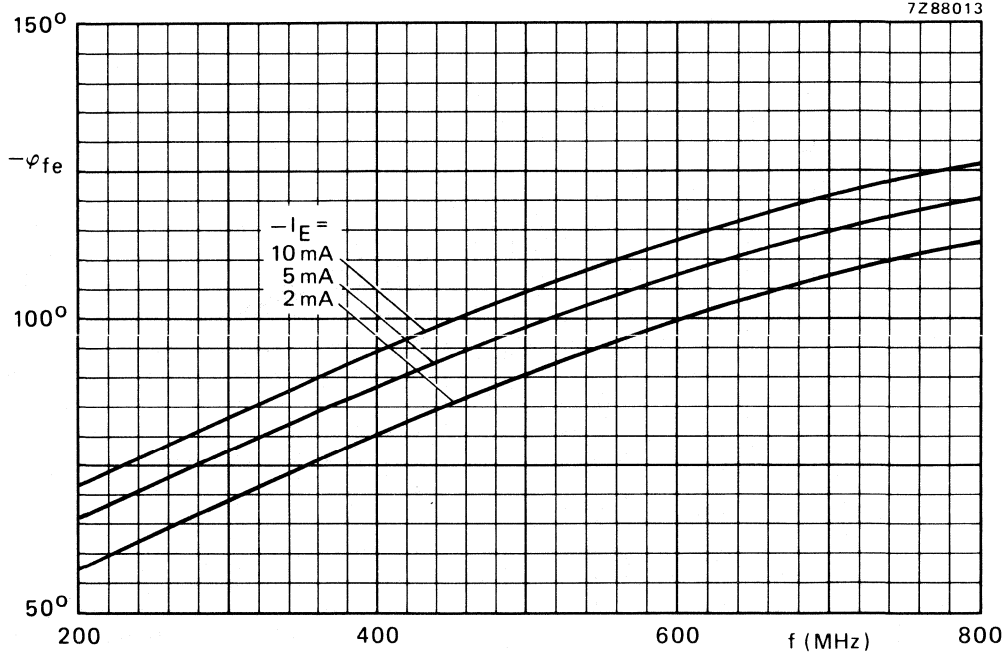

Fig. 9  $V_{CB} = 10$  V;  $T_{amb} = 25$  °C; typical values.

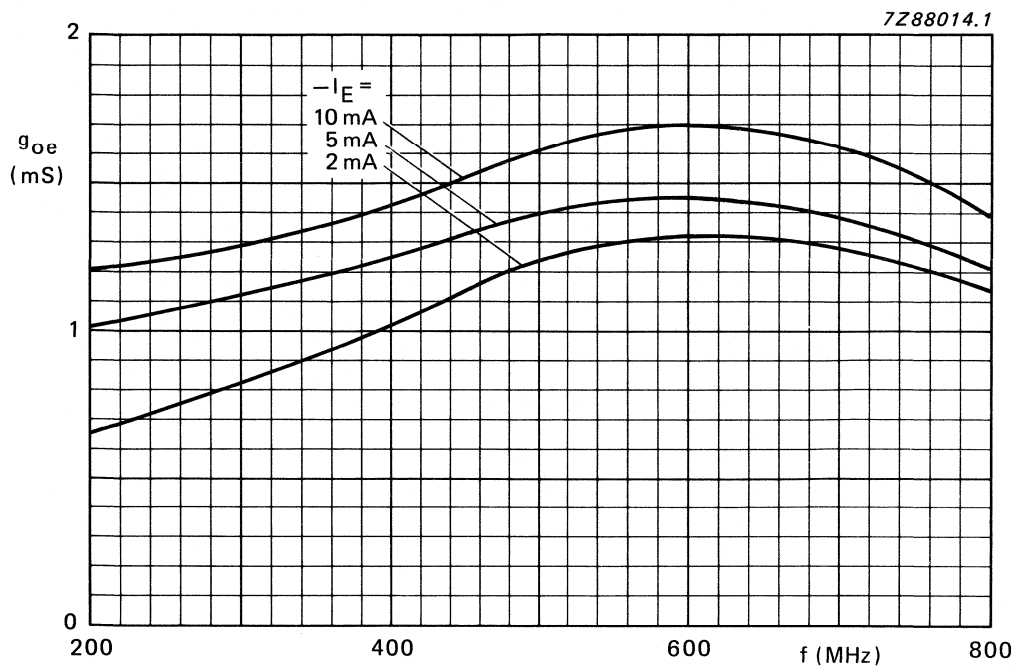

Fig. 10  $V_{CB} = 10$  V;  $T_{amb} = 25$  °C; typical values.

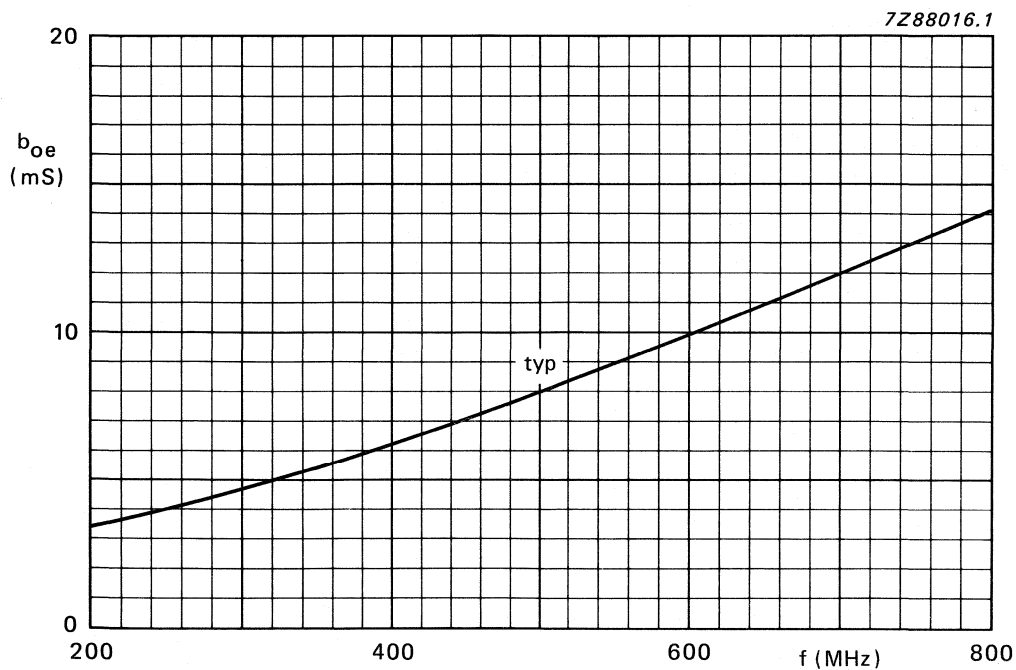

Fig. 11  $V_{CB} = 10$  V;  $-I_E = 2$  to 10 mA;  $T_{amb} = 25$  °C





## SILICON P-N-P HIGH-VOLTAGE TRANSISTORS

Planar epitaxial transistors in TO-39 metal envelopes, intended as general purpose amplifiers and switching devices in industrial and telephone applications.

### QUICK REFERENCE DATA

			BFT44	BFT45	
Collector-base voltage (open emitter)	$-V_{CBO}$	max.	300	250	V
Collector-emitter voltage (open base)	$-V_{CEO}$	max.	300	250	V
Collector current (d.c.)	$-I_C$	max.	0,5		A
Total power dissipation up to $T_{case} = 50\text{ }^\circ\text{C}$	$P_{tot}$	max.	5,0		W
Junction temperature	$T_j$	max.	200		$^\circ\text{C}$
D.C. current gain	$h_{FE}$		50 to 150		
Transition frequency at $f = 35\text{ MHz}$	$f_T$	typ.	70		MHz

### MECHANICAL DATA

Dimensions in mm

Fig. 1 TO-39.

Collector connected to case.

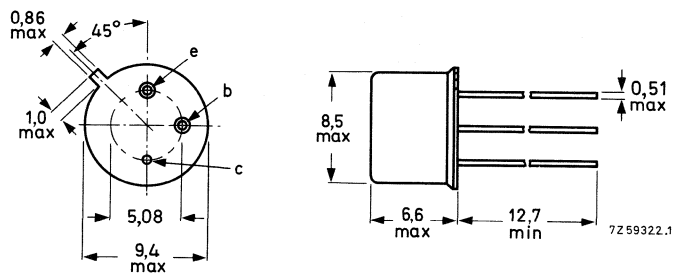

Maximum lead diameter is guaranteed only for 12,7 mm.

**RATINGS**

Limiting values in accordance with the Absolute Maximum System (IEC 134)

			<b>BFT44</b>	<b>BFT45</b>	
Collector-base voltage (open emitter)	$-V_{CBO}$	max.	300	250	V
Collector-emitter voltage (open base)	$-V_{CEO}$	max.	300	250	V
Emitter-base voltage (open collector)	$-V_{EBO}$	max.	5	5	V
Collector current (d.c.)	$-I_C$	max.	0,5	A	
Total power dissipation up to $T_{case} = 50\text{ }^{\circ}\text{C}$	$P_{tot}$	max.	5,0	W	

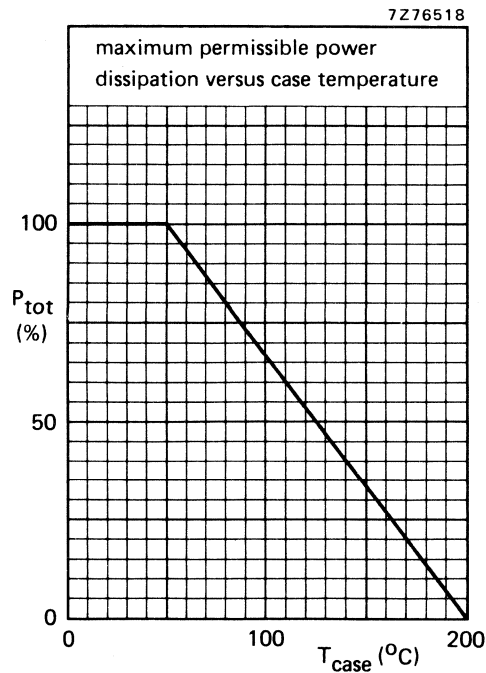

Fig. 2.

Storage temperature range	$T_{stg}$	=	-65 to + 150	$^{\circ}\text{C}$
Junction temperature	$T_j$	max.	200	$^{\circ}\text{C}$

**THERMAL RESISTANCE**

From junction to ambient in free air	$R_{thj-a}$	=	200	K/W
From junction to case	$R_{thj-c}$	=	30	K/W

**CHARACTERISTICS**

$T_j = 25\text{ }^\circ\text{C}$  unless otherwise specified

Collector cut-off current

$I_E = 0; -V_{CB} = 200\text{ V}$

$-I_{CBO} < 5\text{ }\mu\text{A}$

Emitter cut-off current

$I_C = 0; -V_{EB} = 3\text{ V}$

$-I_{EBO} < 5\text{ }\mu\text{A}$

Collector-emitter sustaining voltage

$-I_C = 10\text{ mA}; I_B = 0; L = 25\text{ mH}$

	<b>BFT44</b>	<b>BFT45</b>
$-V_{CEOsust}$	$> 300$	$250\text{ V}^*$

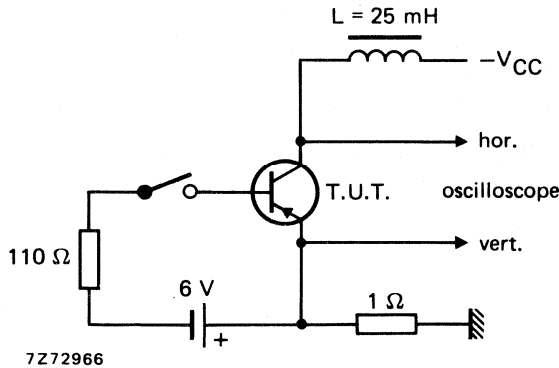

Fig. 3 Test circuit for  $V_{CEOsust}$ .

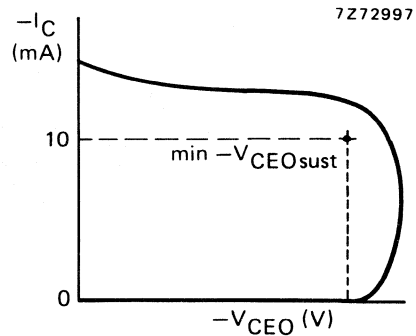

Fig. 4 Oscilloscope display for  $V_{CEOsust}$ .

Saturation voltages

$-I_C = 10\text{ mA}; -I_B = 1\text{ mA}$

$-V_{CEsat} < 0,5\text{ V}$

$-I_C = 100\text{ mA}; -I_B = 10\text{ mA}$

$-V_{BEsat} < 0,8\text{ V}$

$-I_C = 500\text{ mA}; -I_B = 100\text{ mA}$

**BFT44**  
**BFT45**

$-V_{CEsat} < 1,4\text{ V}$

$-V_{BEsat} < 0,9\text{ V}$

$-V_{CEsat} < 5,0\text{ V}^{**}$

$-V_{CEsat} < 3,0\text{ V}^{**}$

$-V_{BEsat} < 1,2\text{ V}^{**}$

D.C. current gain

$-I_C = 1\text{ mA}; -V_{CE} = 10\text{ V}$

$h_{FE} > 30$

$-I_C = 10\text{ mA}; -V_{CE} = 10\text{ V}$

$h_{FE} 50\text{ to }150$

$-I_C = 100\text{ mA}; -V_{CE} = 10\text{ V}$

$h_{FE} > 50\text{ }^{**}$

Collector capacitance at  $f = 1\text{ MHz}$

$I_E = I_e = 0; -V_{CB} = 20\text{ V}$

$C_C < 15\text{ pF}$

\*  $-V_{CC} = 0\text{ to }50\text{ V}; f = 400\text{ Hz}; \delta = 0,5$  (see also test circuit).

\*\* Measured under pulse conditions:  $t_p = 300\text{ }\mu\text{s}; \delta \leq 0,02$ .

**CHARACTERISTICS** (continued)

$T_j = 25\text{ }^\circ\text{C}$

Transition frequency at  $f = 35\text{ MHz}$

$-I_C = 15\text{ mA}; -V_{CE} = 10\text{ V}$

$f_T$  typ. 70 MHz

Switching times

$-I_{Con} = 50\text{ mA}; -I_{Bon} = I_{Boff} = 5\text{ mA}$  (test circuit 1)

$t_{on}$  typ. 125 ns

$t_{off}$  typ. 850 ns

$-I_{Con} = 500\text{ mA}; -I_{Bon} = I_{Boff} = 100\text{ mA}$  (test circuit 2)

$t_{on}$  typ. 125 ns

$t_{off}$  typ. 125 ns

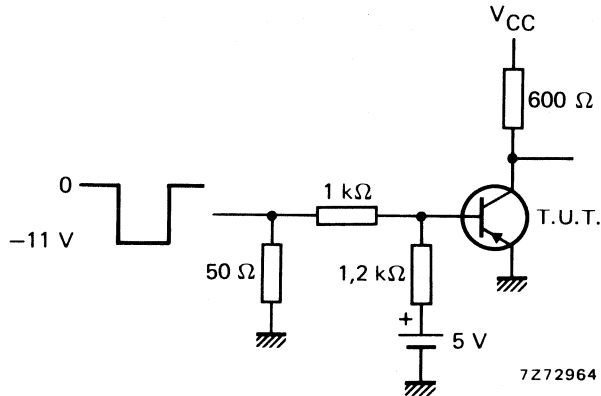

Fig. 5 Test circuit 1.

$V_{CC} = -31\text{ V}$

$t_p = 10\text{ }\mu\text{s}$

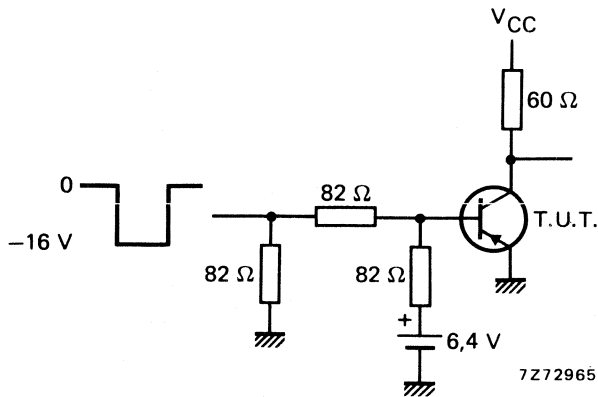

Fig. 6 Test circuit 2.

$V_{CC} = -31\text{ V}$

$t_p = 10\text{ }\mu\text{s}$

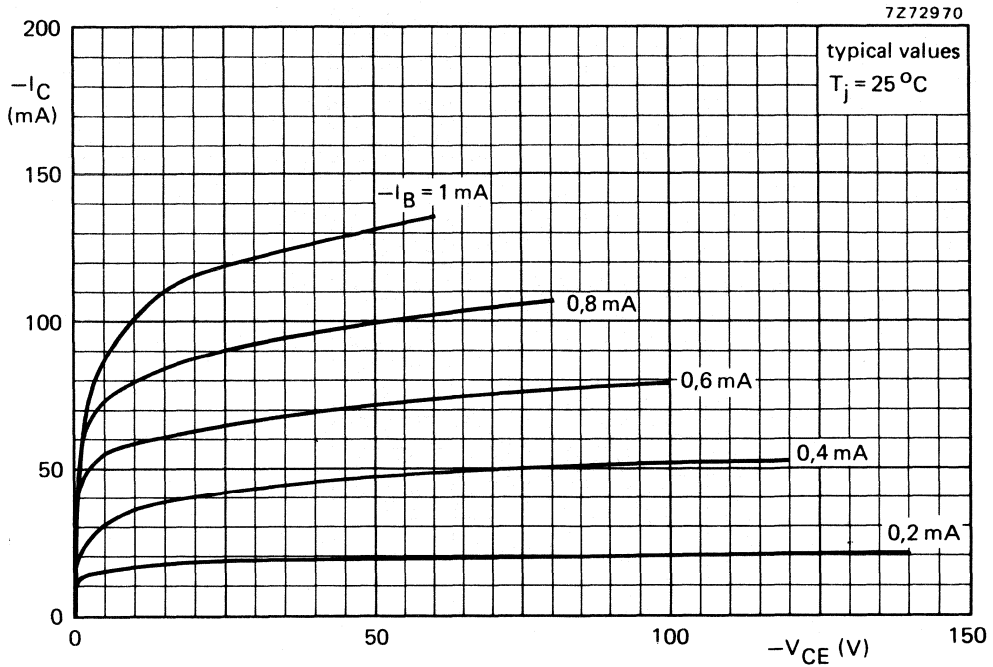

Fig. 7.

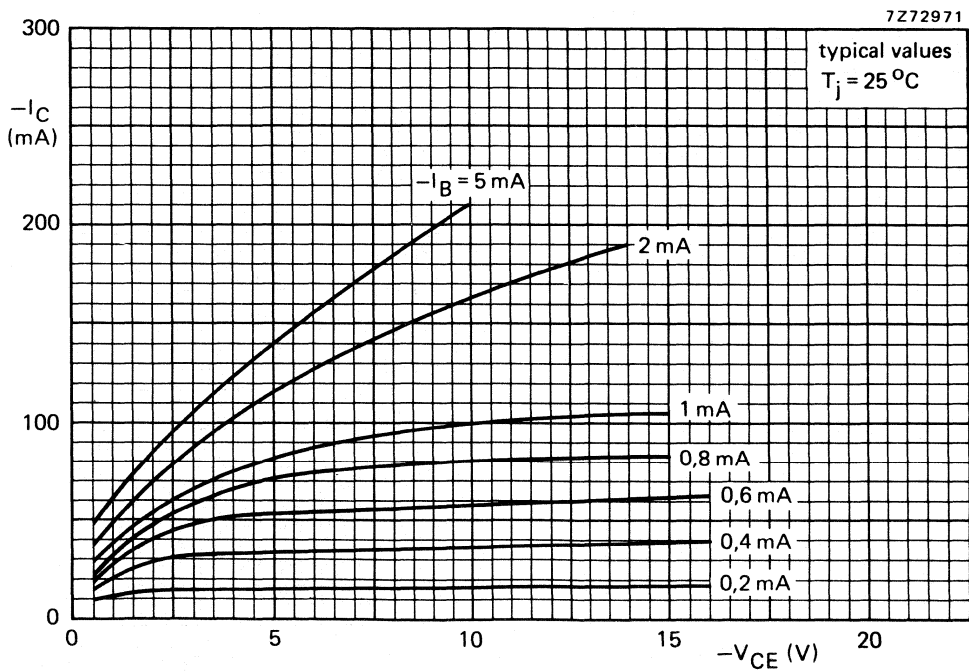

Fig. 8.

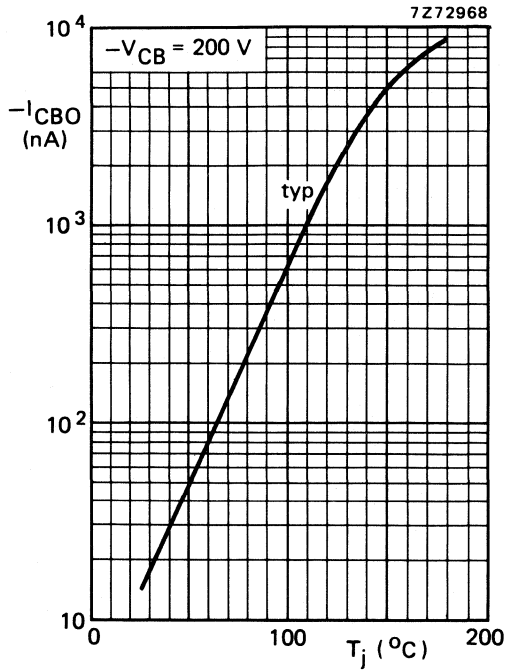

Fig. 9.

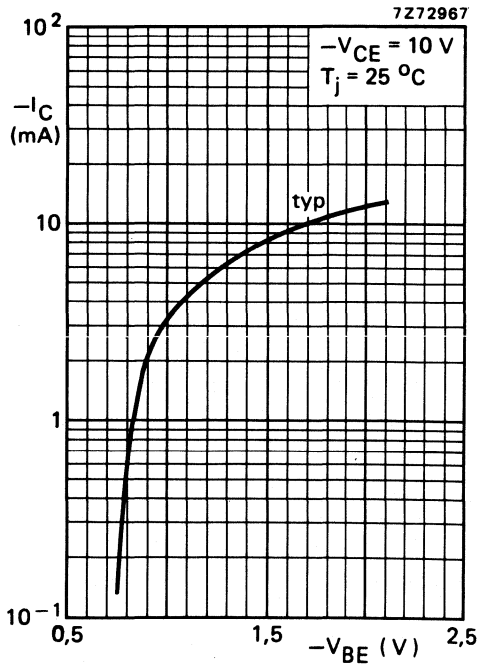

Fig. 10.

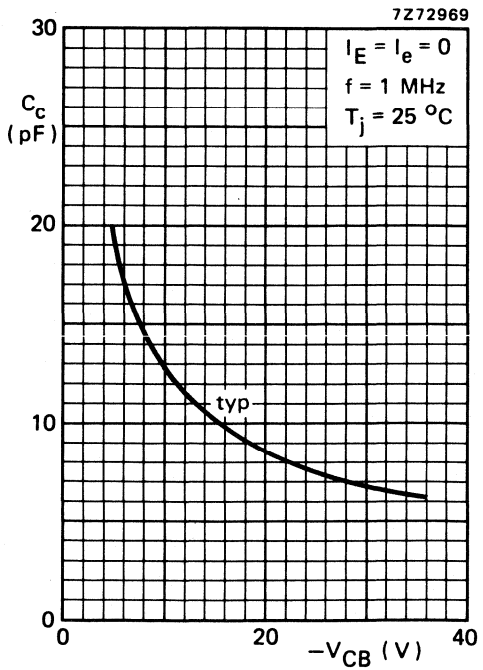

Fig. 11.

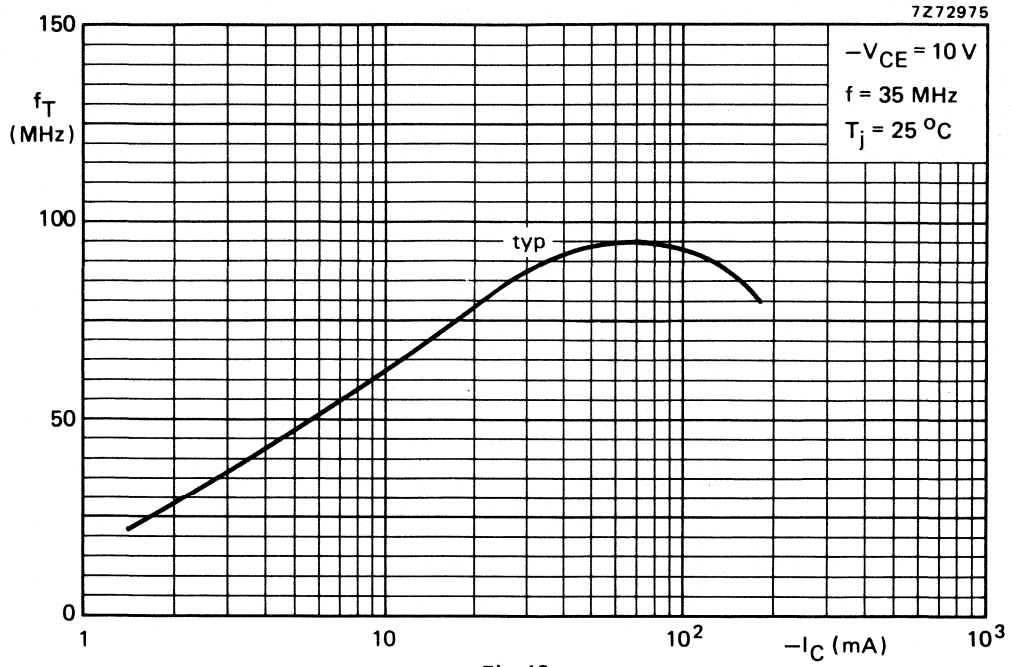

Fig. 12.

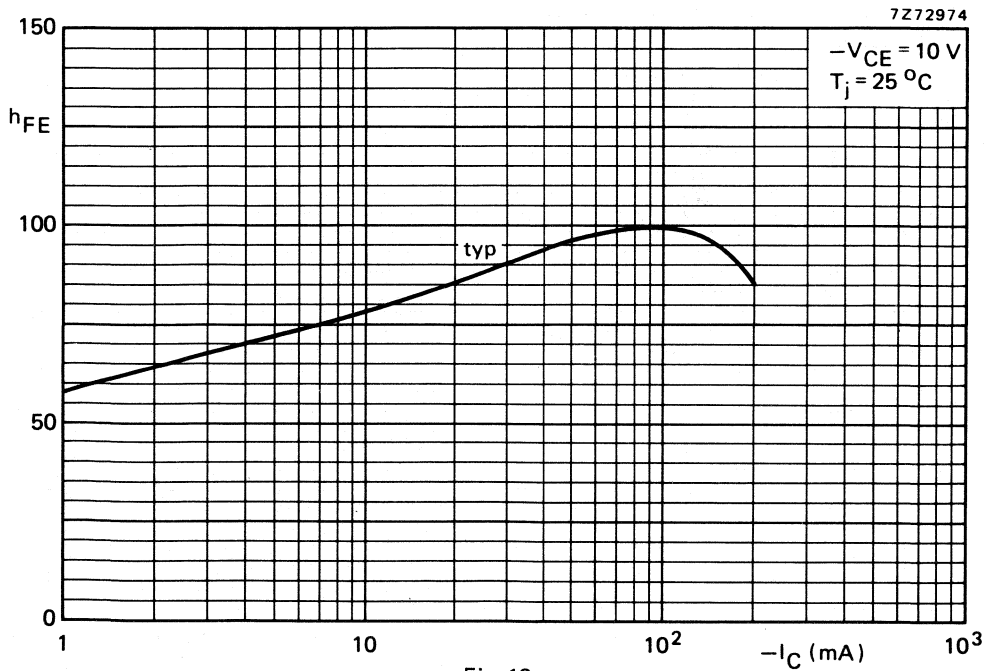

Fig. 13.

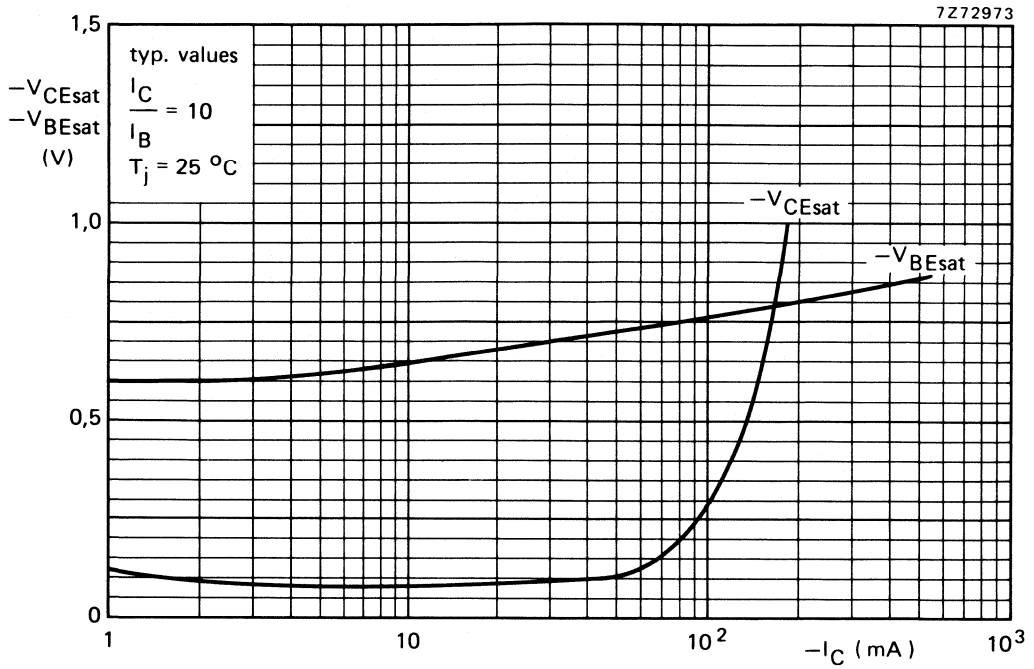

Fig. 14.

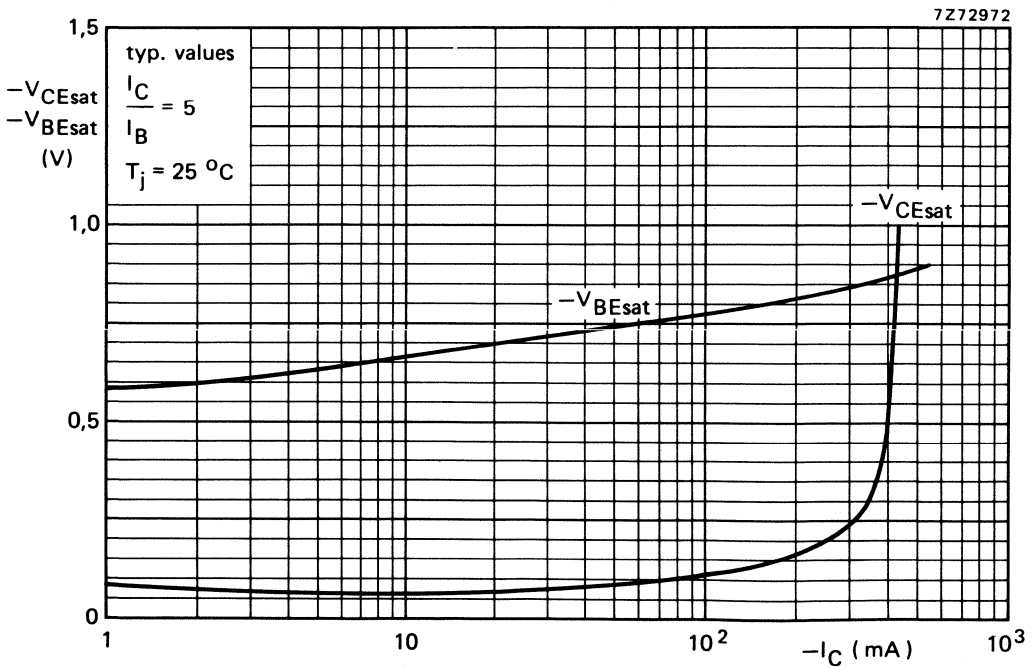

Fig. 15.



## SILICON PLANAR EPITAXIAL TRANSISTOR



PNP transistor in a TO-39 metal envelope for general industrial applications.

### QUICK REFERENCE DATA

Collector-base voltage (open emitter)	$-V_{CBO}$	max.	60 V
Collector-emitter voltage (open base)	$-V_{CEO}$	max.	60 V
Collector current (peak value)	$-I_{CM}$	max.	600 mA
Total power dissipation up to $T_{amb} = 25\text{ }^{\circ}\text{C}$	$P_{tot}$	max.	600 mW
DC current gain			
$-I_C = 10\text{ mA}; -V_{CE} = 10\text{ V}$	$h_{FE}$	min.	50
Transition frequency at $f = 100\text{ MHz}$			
$-I_C = 50\text{ mA}; -V_{CE} = 10\text{ V}$	$f_T$	min.	100 MHz

### MECHANICAL DATA

Dimensions in mm

Fig.1 TO-39.

Collector connected to case

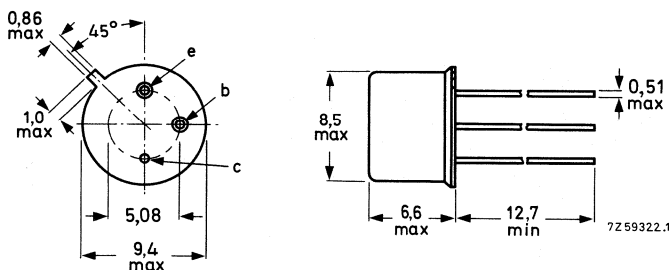

Maximum lead diameter is guaranteed only for 12.7 mm.

**RATINGS**

Limiting values in accordance with the Absolute Maximum System (IEC 134)

Collector-base voltage (open emitter)	$-V_{CBO}$	max.	60 V
Collector-emitter voltage (open base)	$-V_{CEO}$	max.	60 V
Emitter-base voltage (open collector)	$-V_{EBO}$	max.	5.0 V
Collector current (DC)	$-I_C$	max.	600 mA
peak value	$-I_{CM}$	max.	600 mA
Total power dissipation up to $T_{amb} = 25\text{ }^\circ\text{C}$	$P_{tot}$	max.	600 mW
Storage temperature range	$T_{stg}$		$-65\text{ to }+150\text{ }^\circ\text{C}$
Junction temperature	$T_j$	max.	200 $^\circ\text{C}$

**THERMAL RESISTANCE**

From junction to ambient in free air	$R_{th\ j-a}$	=	300 K/W
--------------------------------------	---------------	---	---------

**CHARACTERISTICS**

$T_j = 25\text{ }^\circ\text{C}$  unless otherwise specified

DC current gain

$-I_C = 0.1\text{ mA}; -V_{CE} = 10\text{ V}$	$h_{FE}$	min.	20
$-I_C = 1.0\text{ mA}; -V_{CE} = 10\text{ V}$	$h_{FE}$	min.	40
$-I_C = 10\text{ mA}; -V_{CE} = 10\text{ V}$	$h_{FE}$	min.	50
$-I_C = 50\text{ mA}; -V_{CE} = 10\text{ V}$	$h_{FE}$	min.	50
$-I_C = 150\text{ mA}; -V_{CE} = 10\text{ V}$	$h_{FE}$	min.	40

Transition frequency at  $f = 100\text{ MHz}$

$-I_C = 50\text{ mA}; -V_{CE} = 10\text{ V}$	$f_T$	min.	100 MHz
--	-------	------	---------

Collector-emitter saturation voltage

$-I_C = 150\text{ mA}; -I_B = 15\text{ mA}$	$-V_{CE(sat)}$	typ.	0.15 V
		max.	0.40 V

Base-emitter saturation voltage

$-I_C = 30\text{ mA}; -I_B = 1.0\text{ mA}$	$-V_{BE(sat)}$	typ.	0.77 V
		max.	0.90 V
$-I_C = 30\text{ mA}; -I_B = 1.0\text{ mA}$	$-V_{BE(sat)}$	typ.	1.05 V
		max.	1.30 V

Collector capacitance

$-V_{CB} = 10\text{ V}; I_E = I_e = 0; f = 1.0\text{ MHz}$	$C_c$	typ.	6.0 pF
		max.	12 pF

Emitter capacitance

$-V_{EB} = 2.0\text{ V}; I_C = I_c = 0; f = 1.0\text{ MHz}$	$C_e$	typ.	18 pF
		max.	30 pF

**Saturated switching times** (see Figs 2 and 3)

Turn-on time	$t_{on}$	typ.	25 ns
		max.	60 ns
Turn-off time	$t_{off}$	typ.	55 ns
		max.	150 ns

**h-parameters**

Measured at  $-I_C = 10$  mA;  $-V_{CE} = 10$  V;  $f = 1.0$  kHz;  $T_{amb} = 25$  °C

Input impedance	$h_{ie}$	typ.	600 $\Omega$
Voltage feedback ratio	$h_{re}$	typ.	$1.5 \times 10^{-4}$
Forward current transfer ratio	$h_{fe}$	typ.	155
Output admittance	$h_{oe}$	typ.	104 $\mu$ mho

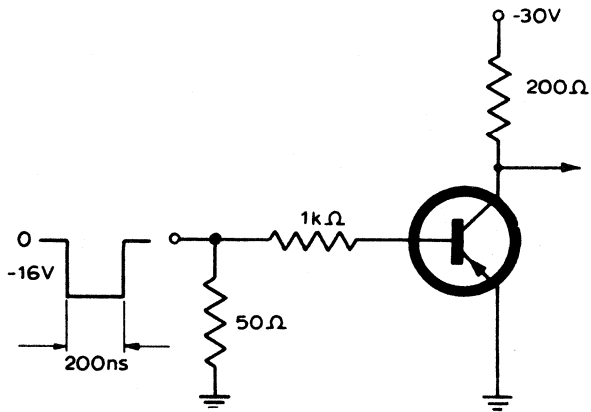

Fig.2 Saturated turn-on switching time.

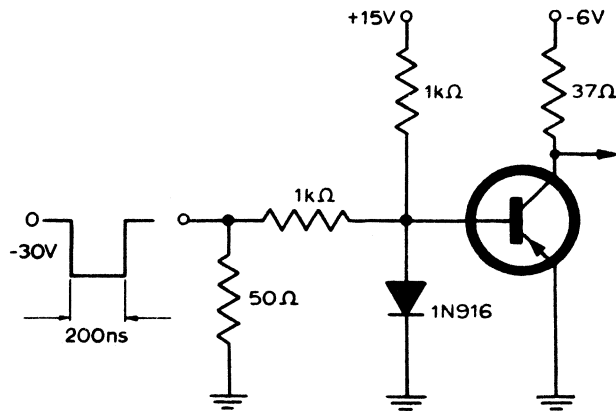

Fig.3 Saturated turn-off switching time.

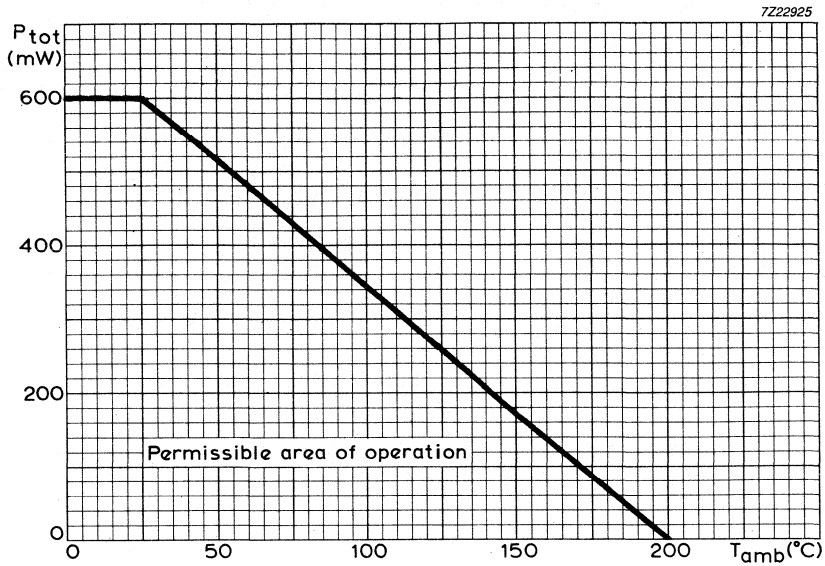

Fig.4 Maximum total dissipation plotted against ambient temperature.

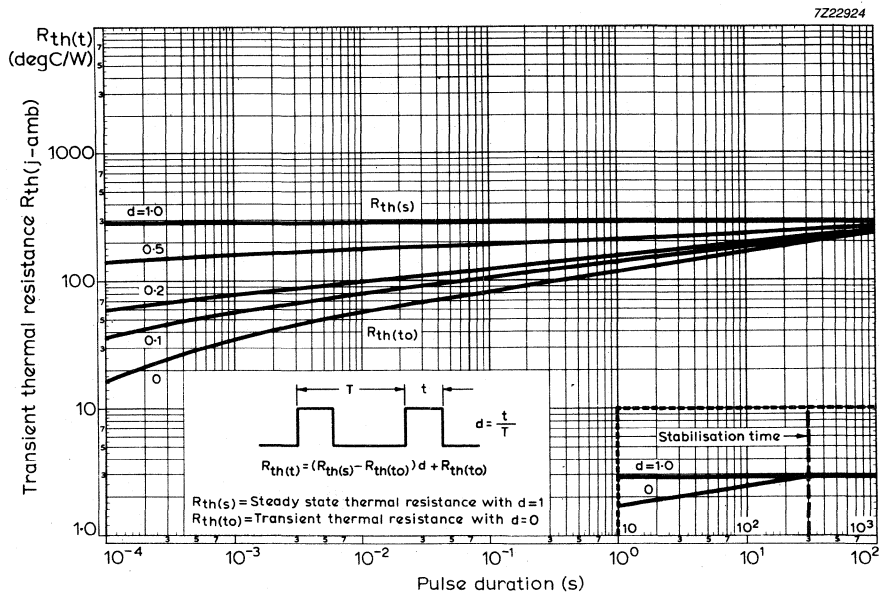

Fig.5 Transient thermal resistance for various duty factors plotted against pulse duration.

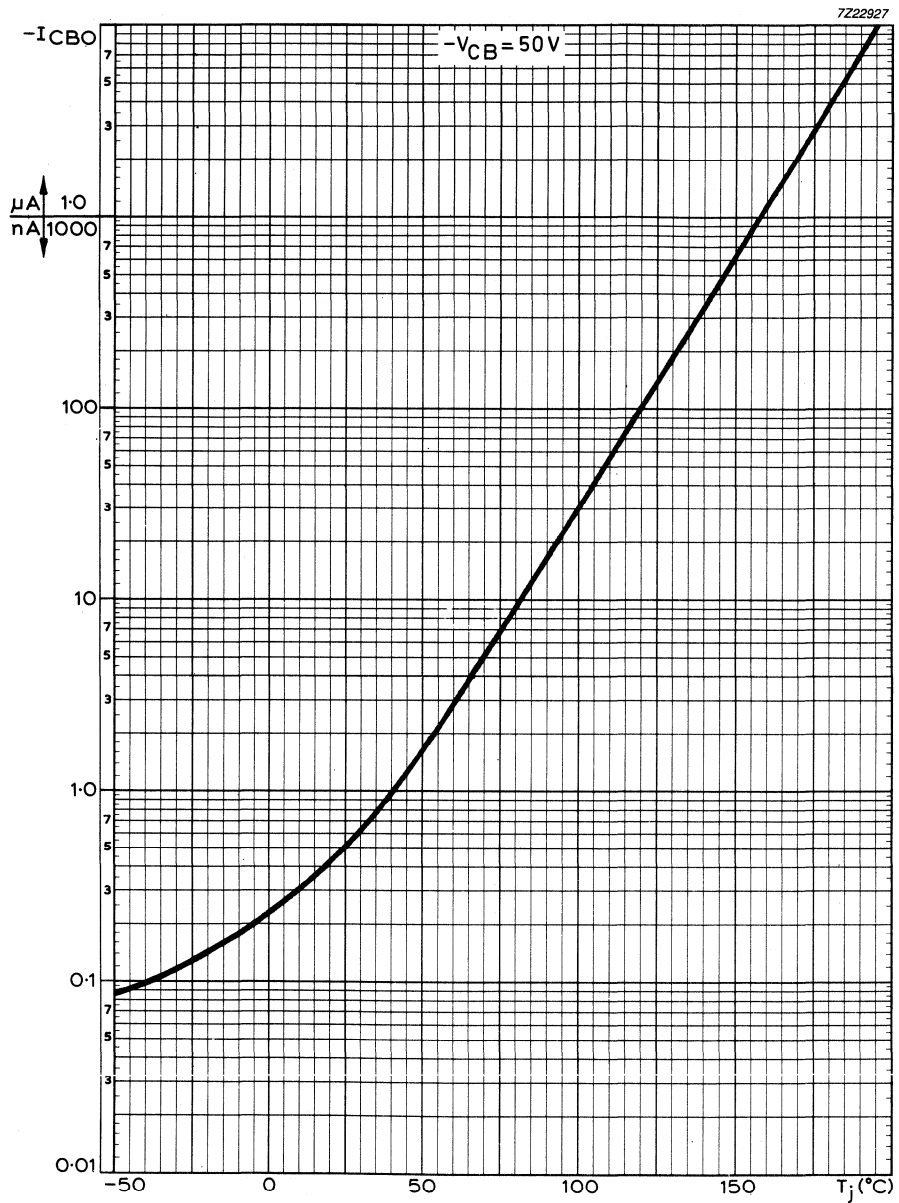

Fig.6 Typical variation of collector cut-off current with junction temperature.

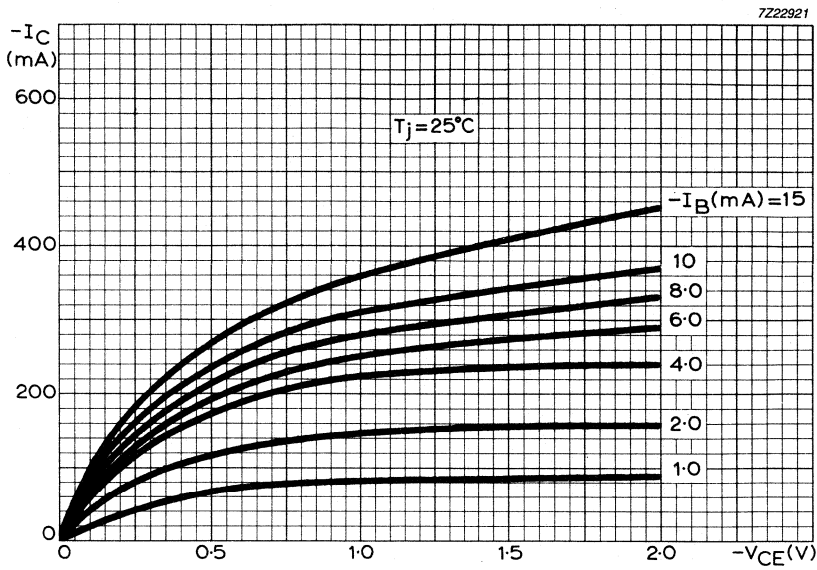

Fig.7 Typical output characteristics at low collector-emitter voltages.

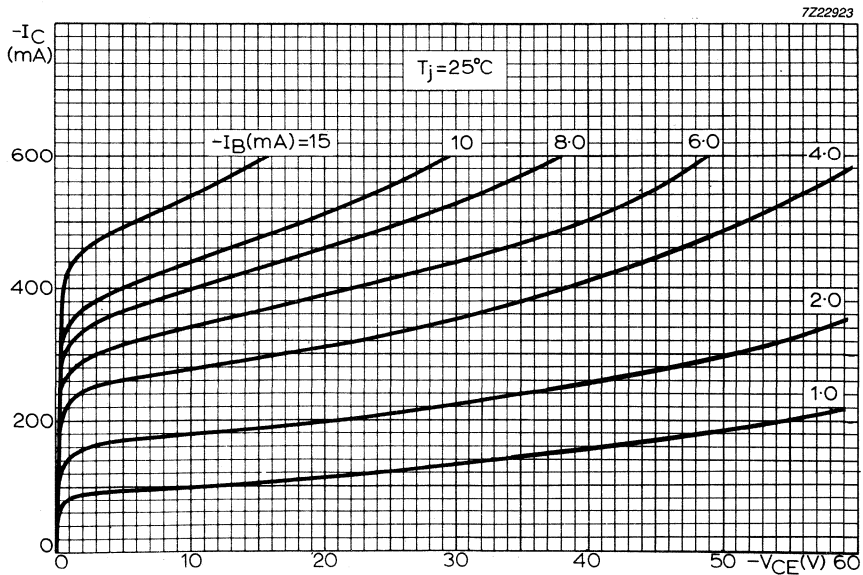

Fig.8 Typical output characteristics at high collector-emitter voltages.

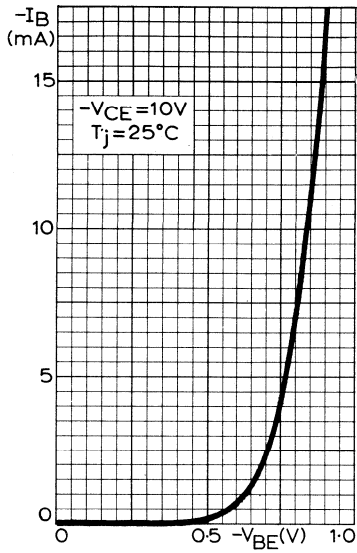

Fig.9 Typical transfer characteristic.

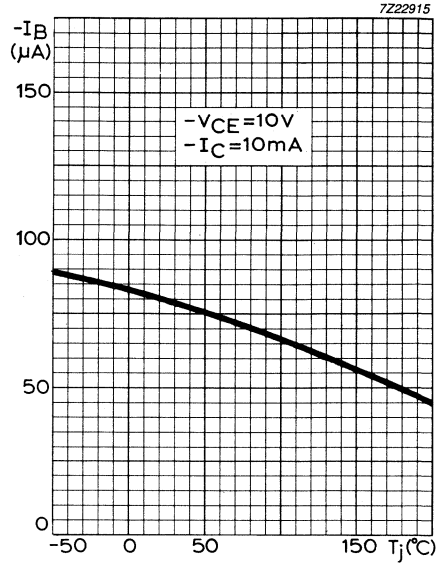

Fig.10 Typical mutual characteristic.

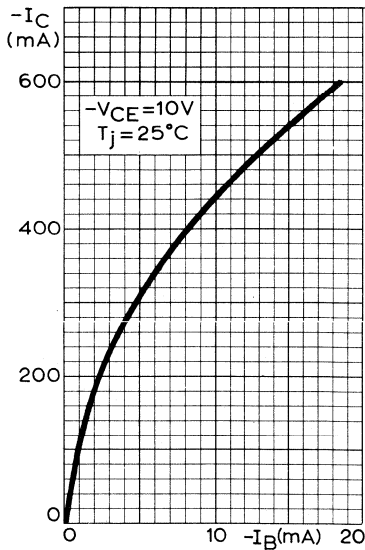

Fig.11 Typical input characteristic.

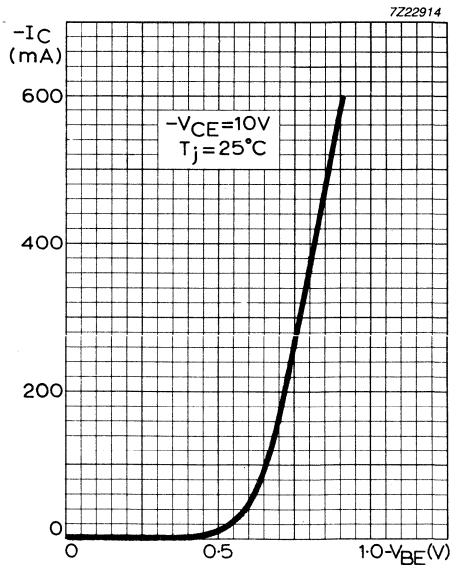

Fig.12 Typical base current as a function of junction temperature.



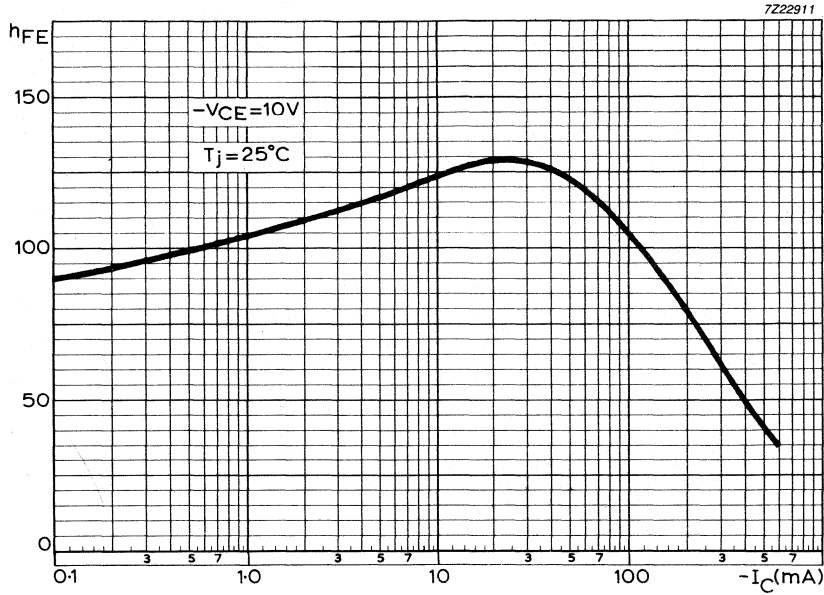

Fig.13 Typical variation of DC current gain with collector current.

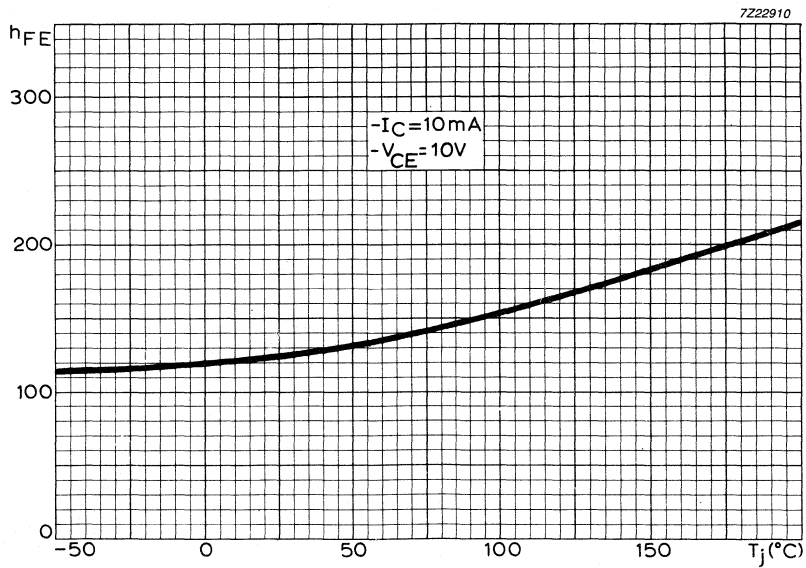

Fig.14 Typical variation of DC current gain with junction temperature.

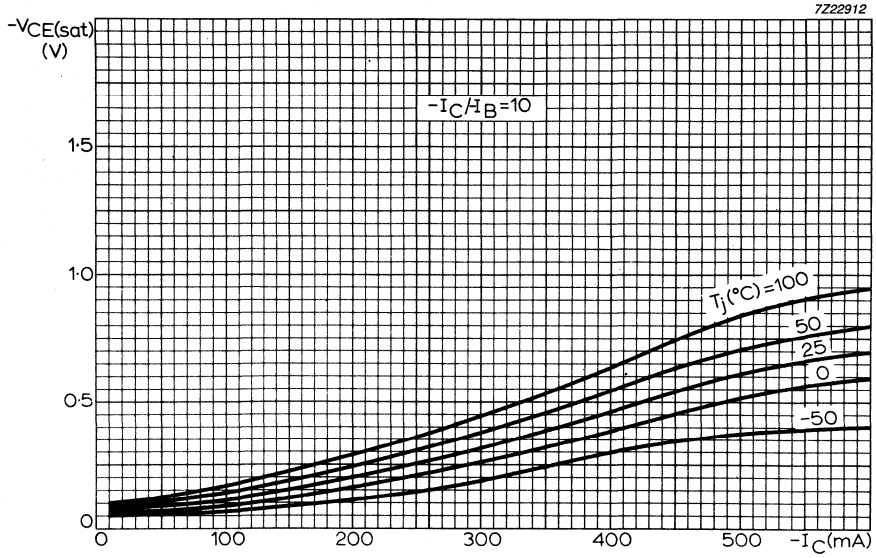

Fig.15 Typical variation of collector-emitter saturation voltage with collector current.

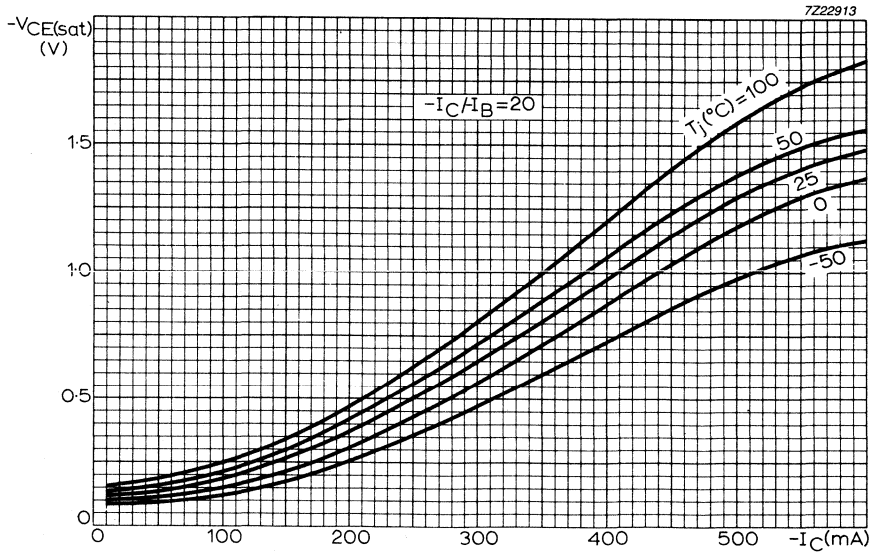

Fig.16 Typical variation of collector-emitter saturation voltage with collector current.

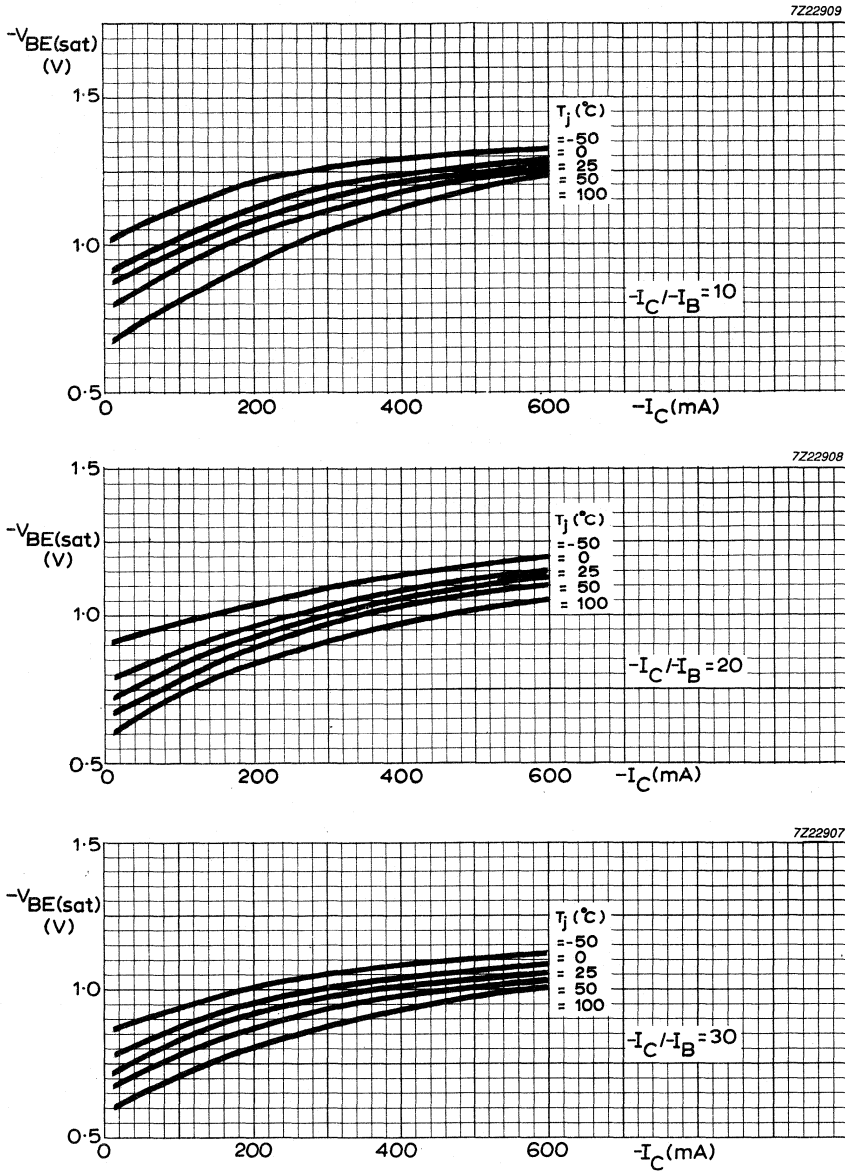

Fig.17 Typical variation of base-emitter saturation voltage with collector current.

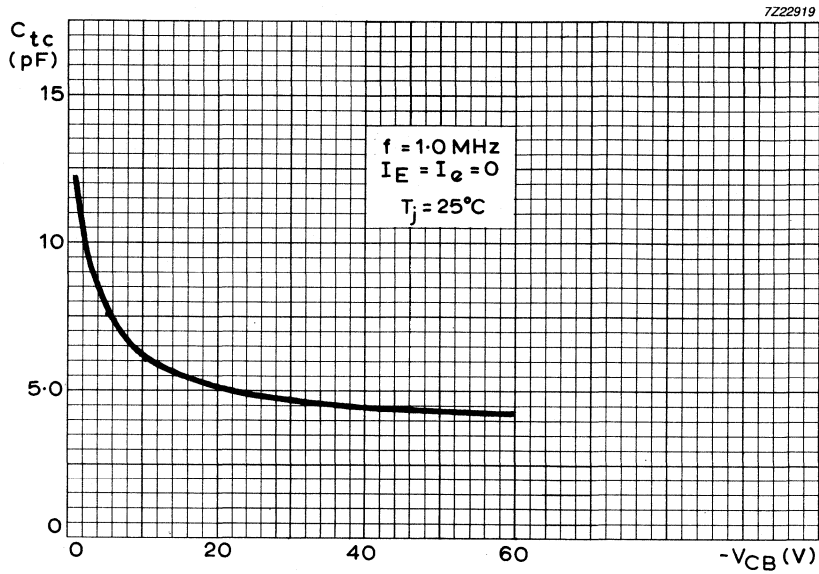

Fig.18 Typical variation of collector capacitance with collector-base voltage.

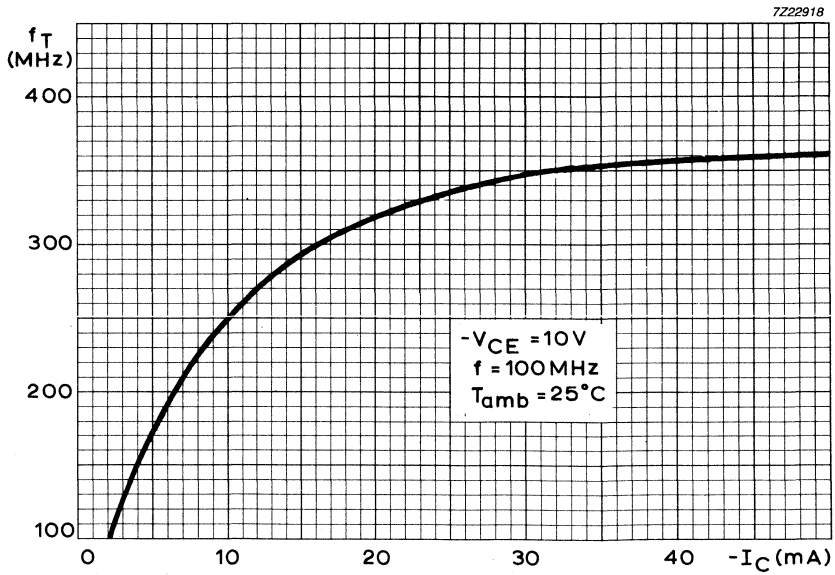

Fig.19 Typical variation of transition frequency with collector current.

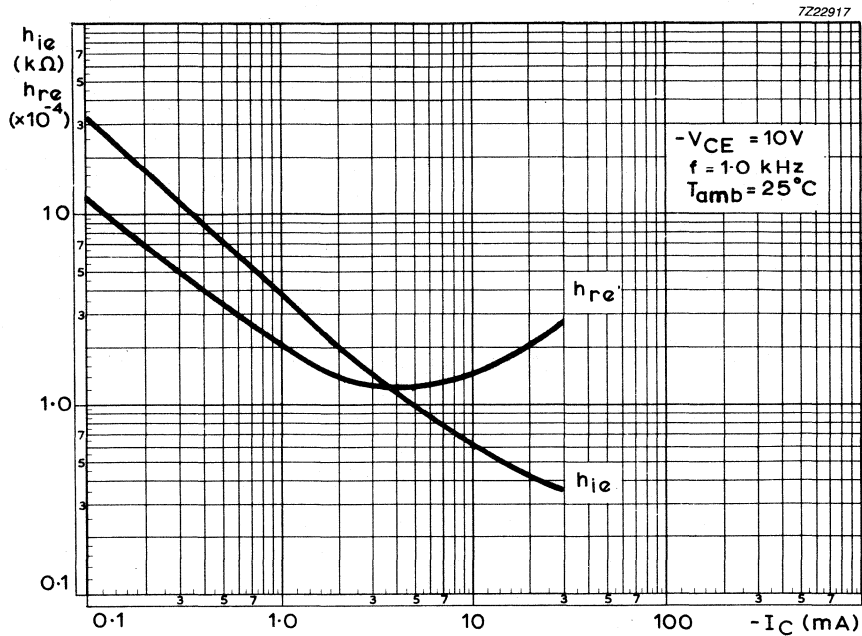

Fig.20 Typical input impedance and typical voltage feedback ratio plotted against collector current.

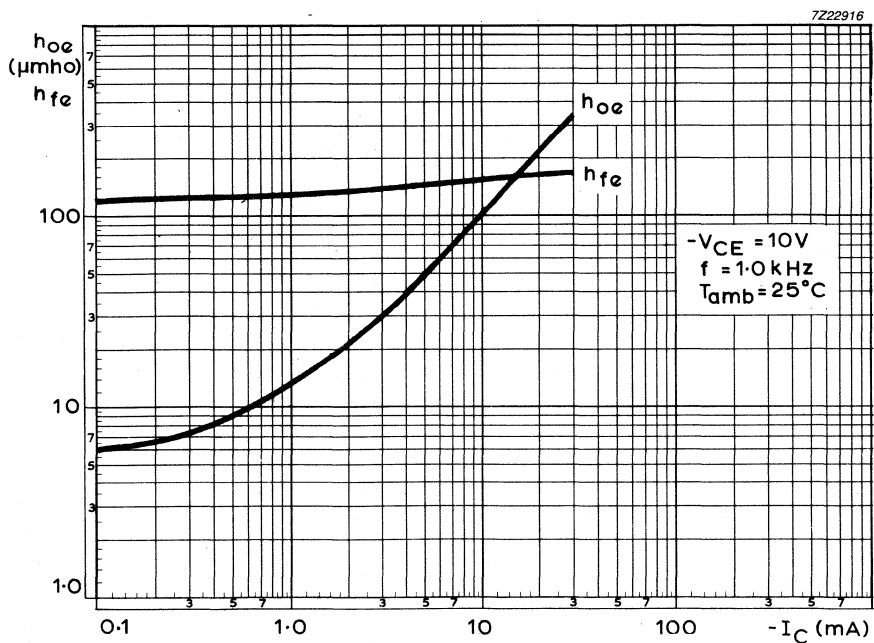

Fig.21 Typical forward current transfer ratio and typical output admittance plotted against collector current.



## SILICON PLANAR EPITAXIAL TRANSISTOR



PNP transistor in a TO-39 metal envelope intended for switching applications.

## QUICK REFERENCE DATA

Collector-base voltage (open emitter)	$-V_{CBO}$ max.	65 V
Collector-emitter voltage (open base)	$-V_{CEO}$ max.	65 V
Collector current (peak value)	$-I_{CM}$ max.	600 mA
Total power dissipation up to $T_{amb} = 25\text{ }^{\circ}\text{C}$	$P_{tot}$ max.	600 mW
DC current gain	$h_{FE}$	typ. 90 50 to 200
$-I_C = 10\text{ mA}; -V_{CE} = 0.4\text{ V}$		
Storage time	$t_s$	max. 250 ns
$-I_{Con} = 100\text{ mA}; -I_{Bon} = I_{Boff} = 10\text{ mA}$		

## MECHANICAL DATA

Dimensions in mm

Fig. 1 TO-39.

Collector connected to case

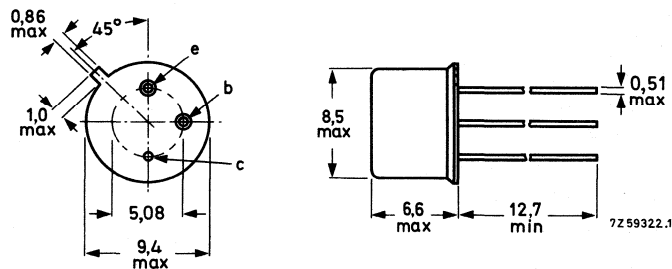

Maximum lead diameter is guaranteed only for 12.7 mm.

**RATINGS**

Limiting values of operation according to the Absolute Maximum System.

Electrical

$-V_{CB0}$	max.	65 V
$-V_{CEO}$	max.	65 V
$-V_{EBO}$	max.	5.0 V
$-I_C$	max.	600 mA
$-I_{CM}$	max.	600 mA
$-I_{EM}$	max.	600 mA
$P_{tot}$ max. ( $T_{amb} \leq 25\text{ }^\circ\text{C}$ )	max.	600 mW

Temperature

$T_{stg}$	min.	-65 $^\circ\text{C}$
$T_{stg}$	max.	150 $^\circ\text{C}$
$T_j$	max.	200 $^\circ\text{C}$

**THERMAL CHARACTERISTIC**

$R_{th(j-amb)}$	300 K/W
-----------------	---------

**CHARACTERISTICS ( $T_j = 25\text{ }^\circ\text{C}$  unless otherwise stated)**

$-I_{CBO}$	Collector cut-off current		
	$-V_{CB} = 65\text{ V}; I_E = 0$	max.	500 nA
	$-V_{CB} = 50\text{ V}; I_E = 0$	max.	50 nA
$-I_{EBO}$	Emitter cut-off current		
	$-V_{EB} = 5.0\text{ V}; I_C = 0$	max.	500 nA
$-V_{BE(sat)}$	Base-emitter saturation voltage		
	$-I_C = 30\text{ mA}; -I_B = 1.0\text{ mA}$	max.	0.90 V
$h_{FE}$	DC current gain		
	$-I_C = 1.0\text{ mA}; -V_{CE} = 0.4\text{ V}$	min.	40
	$-I_C = 10\text{ mA}; -V_{CE} = 0.4\text{ V}$	min.	50
	$-I_C = 50\text{ mA}; -V_{CE} = 0.4\text{ V}$	max.	200
	$-I_C = 150\text{ mA}; -V_{CE} = 0.4\text{ V}$	min.	20
	$-I_C = 150\text{ mA}; -V_{CE} = 0.4\text{ V}$	min.	10



$C_{tc}$	Collector capacitance $-V_{CB} = 10 \text{ V}; I_E = I_e = 0; f = 1.0 \text{ MHz}$	typ.	6.0 pF
$C_{te}$	Emitter capacitance $-V_{EB} = 2.0 \text{ V}; I_C = I_c = 0; f = 1.0 \text{ MHz}$	typ.	18 pF
Saturated switching times			
$-I_C = 100 \text{ mA}; -I_{B\text{on}} = I_{B\text{off}} = 10 \text{ mA}; V_{EE} = 10 \text{ V}; V_{BE\text{off}} = 2.0 \text{ V}$			
$t_d$	Delay time	typ. max.	9 ns 15 ns
$t_r$	Rise time	typ. max.	18 ns 40 ns
$t_{\text{on}}$	Turn-on time ( $t_d + t_r$ )	typ. max.	27 ns 50 ns
$t_s$	Storage time	typ. max.	95 ns 250 ns
$t_f$	Fall time	typ. max.	30 ns 50 ns
$t_{\text{off}}$	Turn-off time ( $t_s + t_f$ )	typ. max.	125 ns 290 ns

ELECTRICAL CHARACTERISTICS (cont'd)

Saturated switching times

Test circuit

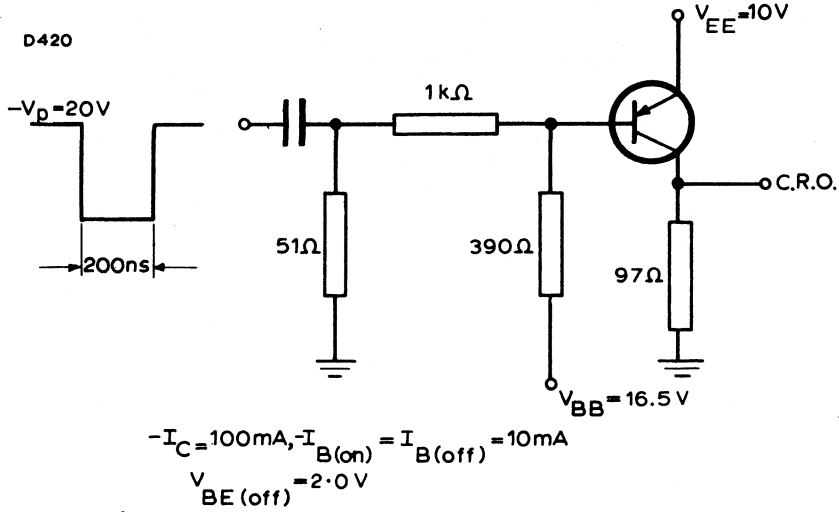

Waveforms

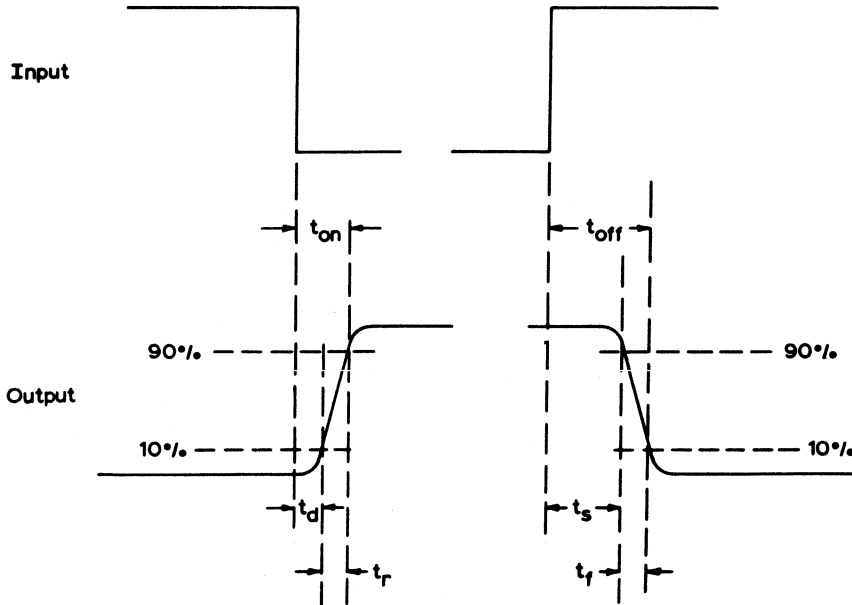

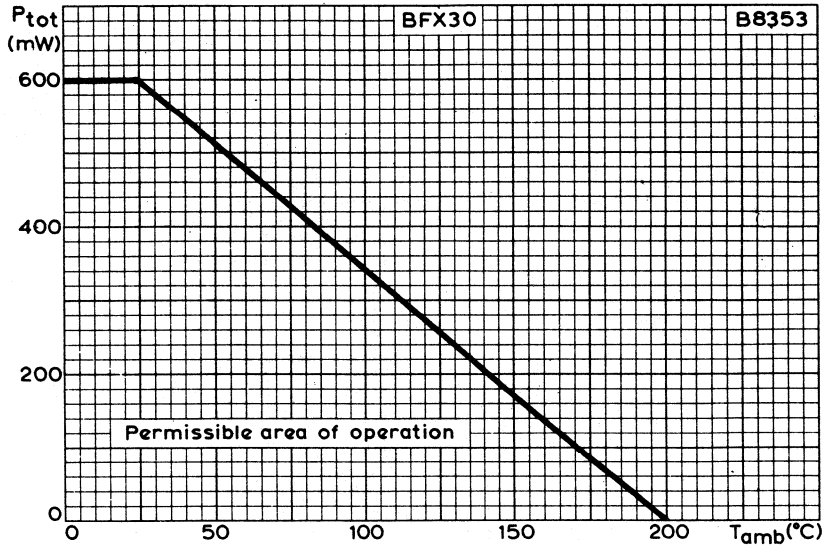

TOTAL DISSIPATION PLOTTED AGAINST AMBIENT TEMPERATURE

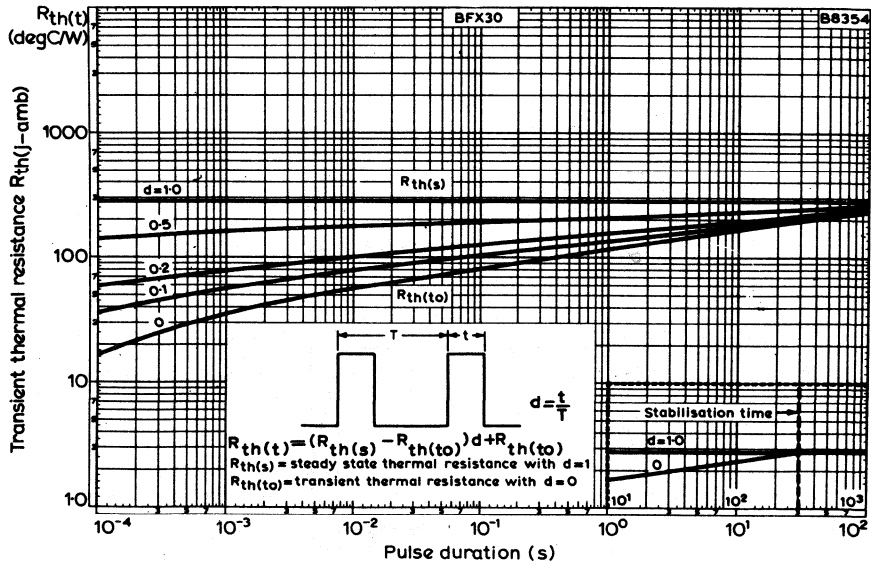

TRANSIENT THERMAL RESISTANCE FOR VARIOUS DUTY FACTORS PLOTTED AGAINST PULSE DURATION

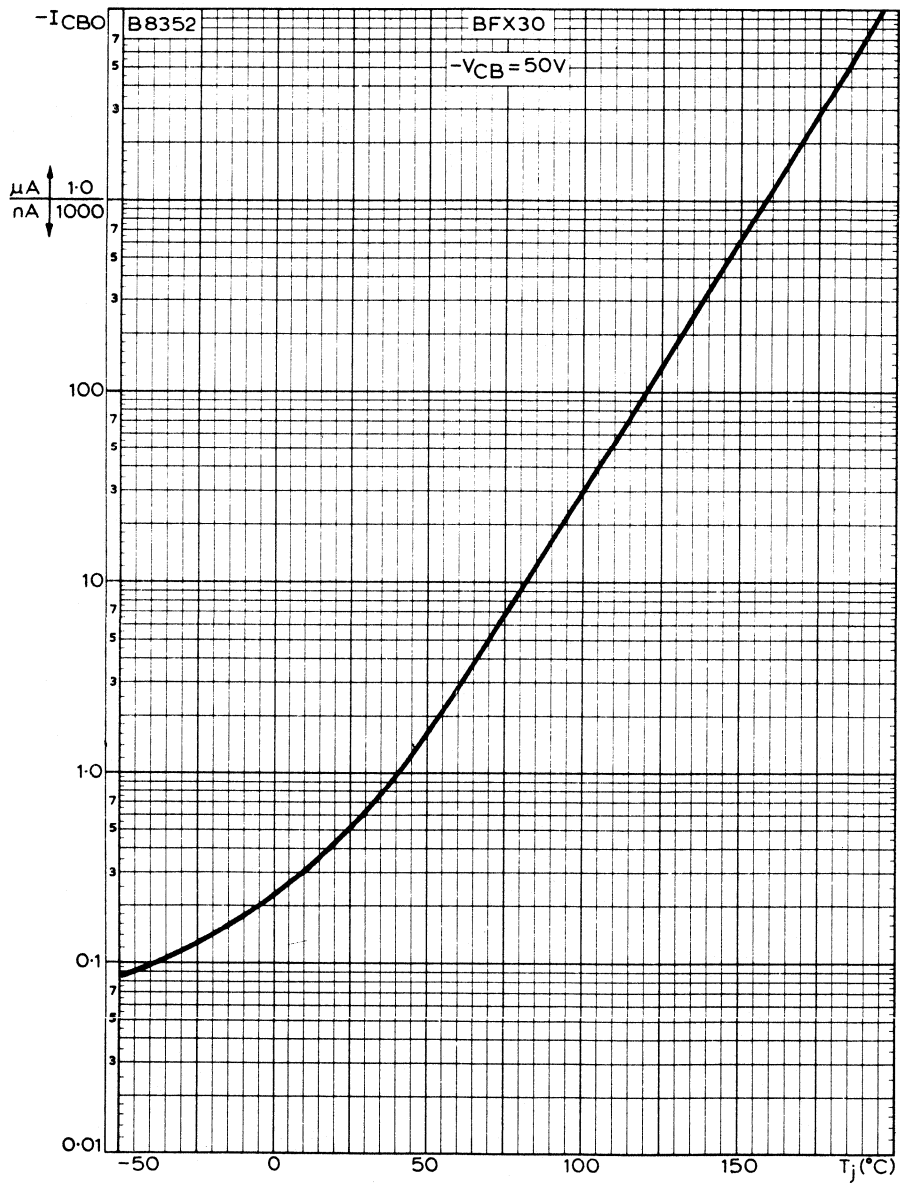

TYPICAL VARIATION OF COLLECTOR CUT-OFF CURRENT WITH JUNCTION TEMPERATURE

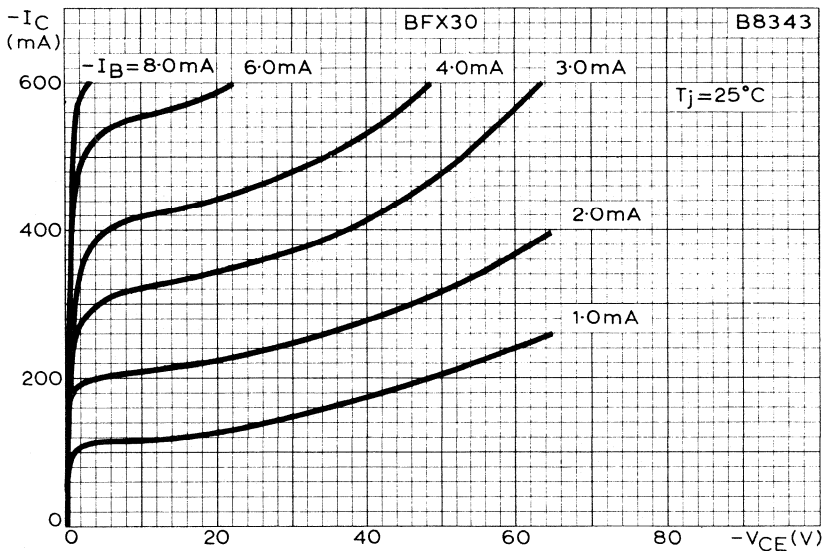
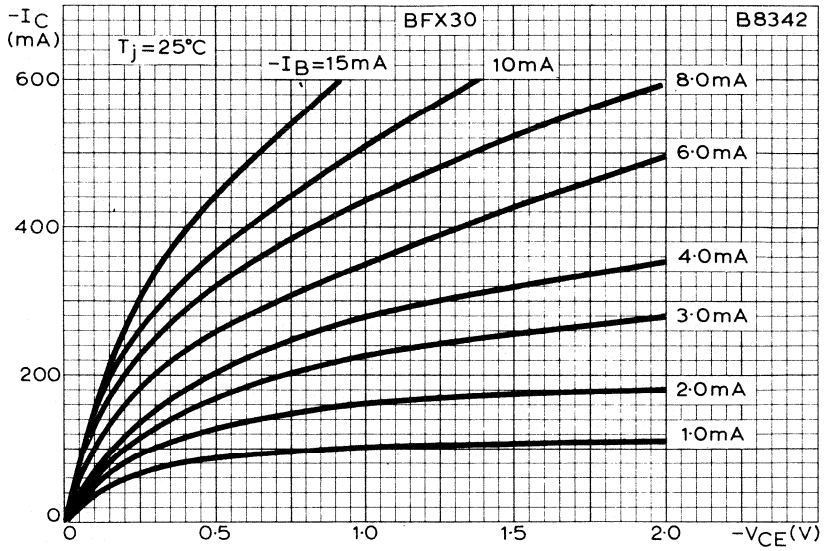

TYPICAL OUTPUT CHARACTERISTICS AT LOW AND HIGH COLLECTOR-EMITTER VOLTAGES

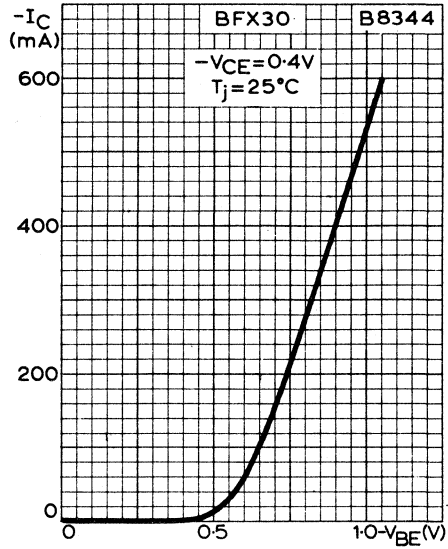
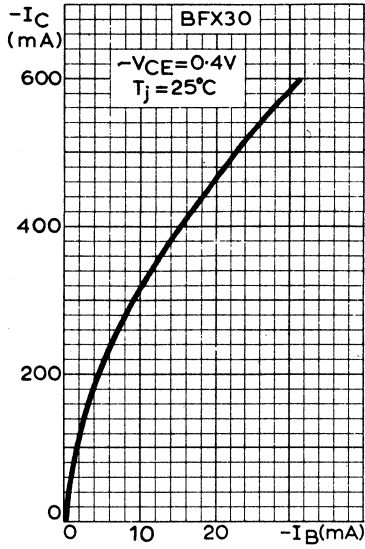

TYPICAL TRANSFER AND MUTUAL CHARACTERISTICS

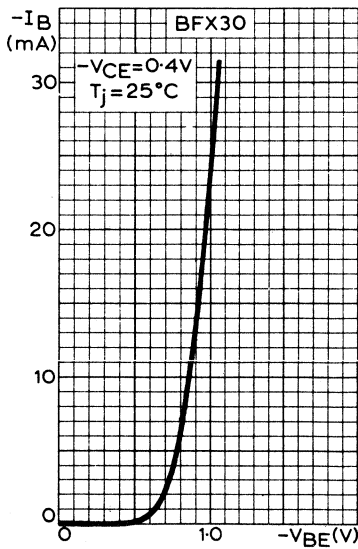

Typical input characteristics

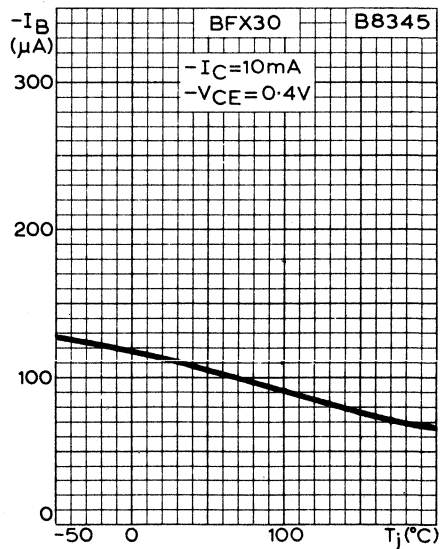

Typical base current versus junction temperature

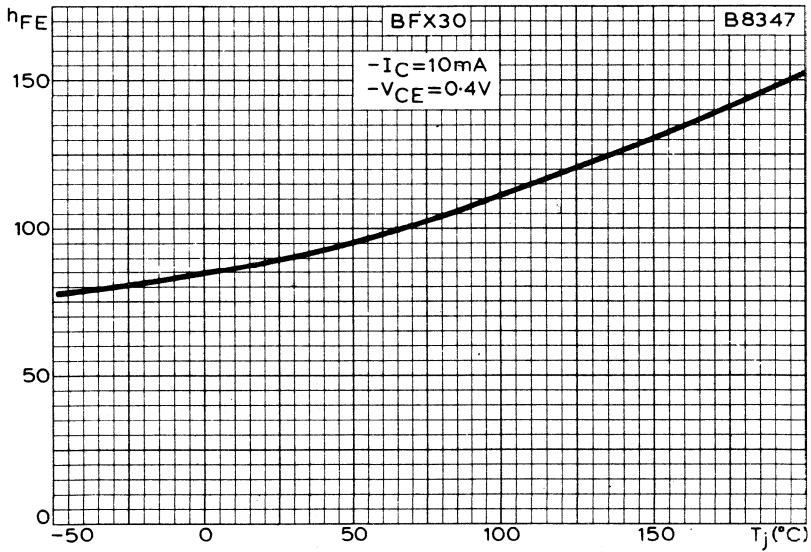
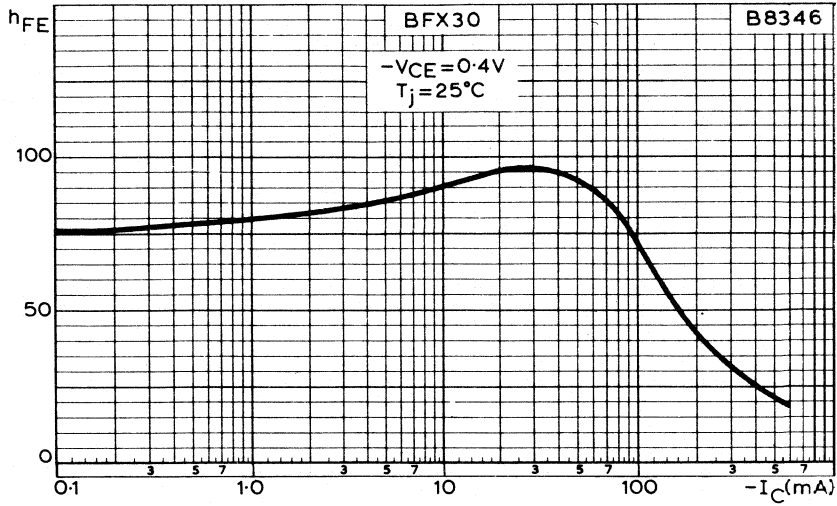

TYPICAL VARIATION OF STATIC FORWARD CURRENT TRANSFER RATIO WITH COLLECTOR CURRENT AND JUNCTION TEMPERATURE

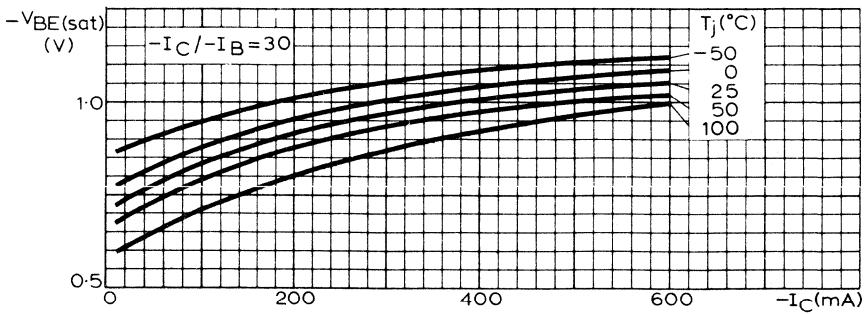
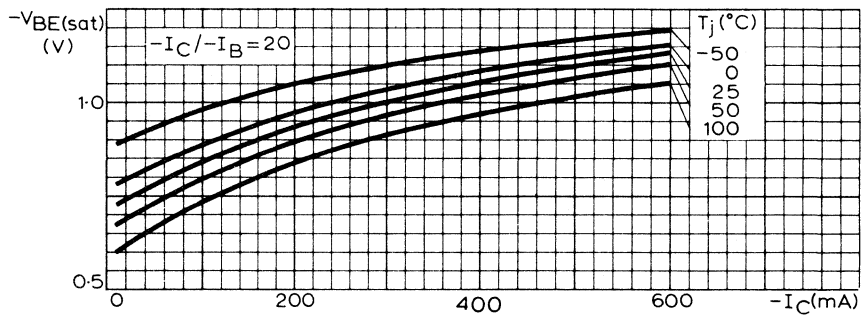
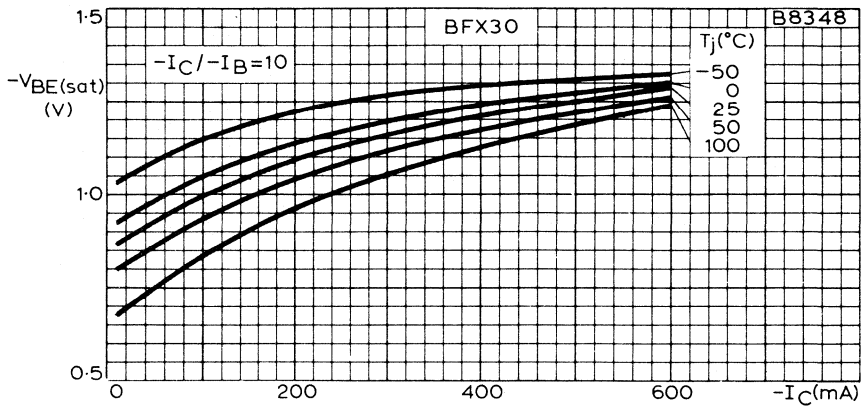

TYPICAL VARIATION OF BASE-EMITTER SATURATION VOLTAGE WITH COLLECTOR CURRENT AND  $I_C/I_B$  RATIO



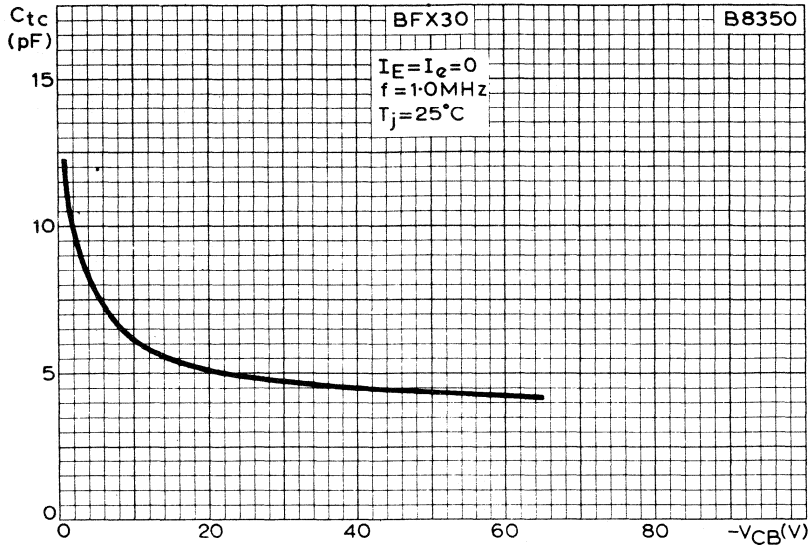

TYPICAL VARIATION OF COLLECTOR CAPACITANCE WITH COLLECTOR-BASE VOLTAGE

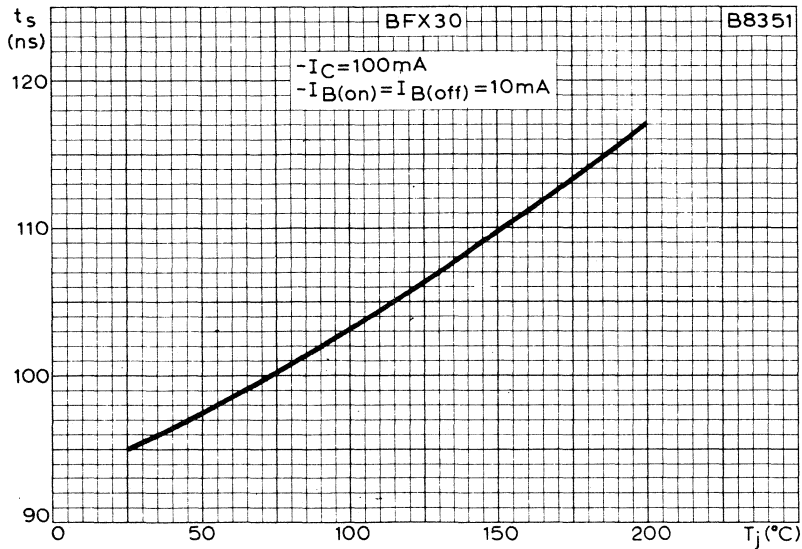

TYPICAL VARIATION OF STORAGE TIME WITH JUNCTION TEMPERATURE



## SILICON PLANAR EPITAXIAL TRANSISTOR



N-P-N transistor in a TO-39 metal envelope primarily intended for use as high-current switching device, e.g. inverters and switching regulators.

## QUICK REFERENCE DATA

Collector-base voltage (open emitter)	$V_{CBO}$	max.	120 V
Collector-emitter voltage (open base)	$V_{CEO}$	max.	60 V
Collector current (peak value)	$I_{CM}$	max.	5,0 A
Total power dissipation up to $T_{case} = 25\text{ }^{\circ}\text{C}$	$P_{tot}$	max.	5,0 W
Junction temperature	$T_j$	max.	200 $^{\circ}\text{C}$
D.C. current gain $I_C = 2\text{ A}; V_{CE} = 2\text{ V}$	$h_{FE}$	40 to	150
Transition frequency at $f = 35\text{ MHz}$ $I_C = 0,5\text{ A}; V_{CE} = 5\text{ V}$	$f_T$	>	70 MHz
Turn-off time when switched from $I_C = 5\text{ A}; I_B = 0,5\text{ A}$ to cut-off with $-I_{BM} = 0,5\text{ A}$	$t_{off}$	<	1,2 $\mu\text{s}$

## MECHANICAL DATA

Dimensions in mm

Fig. 1 TO-39.

Collector connected to case

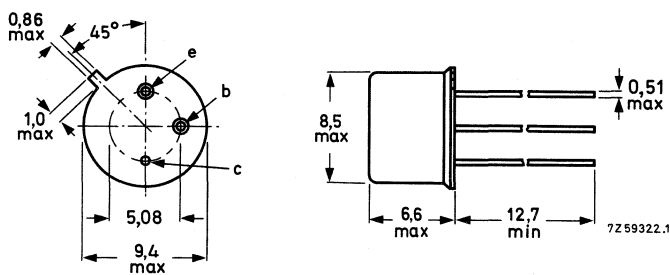

Maximum lead diameter is guaranteed only for 12,7 mm.

**RATINGS**

Limiting values in accordance with the Absolute Maximum System (IEC 134)

Collector-base voltage (open emitter)	$V_{CBO}$	max.	120 V
Collector-emitter voltage (open base)	$V_{CEO}$	max.	60 V
Emitter-base voltage (open collector)	$V_{EBO}$	max.	6 V
Collector current (d.c.)	$I_C$	max.	2,0 A
Collector current (peak value)	$I_{CM}$	max.	5,0 A
Base current (d.c.)	$I_B$	max.	1,0 A
Total power dissipation up to $T_{case} = 25\text{ }^\circ\text{C}$ up to $T_{amb} = 25\text{ }^\circ\text{C}$	$P_{tot}$	max.	5,0 W
	$P_{tot}$	max.	0,87 W
Storage temperature range	$T_{stg}$		-65 to +150 $^\circ\text{C}$
Junction temperature	$T_j$	max.	200 $^\circ\text{C}$

**THERMAL RESISTANCE**

From junction to ambient in free air	$R_{th\ j-a}$	=	200 K/W
From junction to case	$R_{th\ j-c}$	=	35 K/W

## CHARACTERISTICS

$T_j = 25\text{ }^\circ\text{C}$  unless otherwise specified

Collector cut-off current

$V_{EB} = 0; V_{CE} = 60\text{ V}$

$I_{CES} < 10\text{ }\mu\text{A}$

Emitter cut-off current

$I_C = 0; V_{EB} = 4\text{ V}$

$I_{EBO} < 10\text{ }\mu\text{A}$

Saturation voltage

$I_C = 5\text{ A}; I_B = 0,5\text{ A}$

$V_{CEsat}$  typ.  $0,77\text{ V}$   
<  $1,0\text{ V}$

$V_{BEsat}$  typ.  $1,43\text{ V}$   
<  $1,8\text{ V}$

D.C. current gain

$I_C = 1,0\text{ A}; V_{CE} = 2,0\text{ V}$

$h_{FE}$  typ. 130

$I_C = 1,5\text{ A}; V_{CE} = 0,6\text{ V}$

$h_{FE}$  typ. 60

$I_C = 2,0\text{ A}; V_{CE} = 2,0\text{ V}$

$h_{FE}$  typ. 110  
40 to 150

Collector capacitance at  $f = 1\text{ MHz}$

$I_E = I_e = 0; V_{CB} = 10\text{ V}$

$C_C$  typ.  $36\text{ pF}$

Emitter-capacitance at  $f = 1\text{ MHz}$

$I_C = I_c = 0; V_{EB} = 0,5\text{ V}$

$C_e$  typ.  $440\text{ pF}$

Transition frequency at  $f = 35\text{ MHz}$

$I_C = 0,5\text{ A}; V_{CE} = 5\text{ V}$

$f_T > 70\text{ MHz}$   
typ.  $100\text{ MHz}$

Turn on time when switched from

$-V_{BE} = 2,0\text{ V}$  to  $I_C = 5\text{ V}; I_B = 0,5\text{ A}$   
with  $I_{BM} = 0,5\text{ A}$

$t_{on}$  typ.  $0,2\text{ }\mu\text{s}$   
<  $0,6\text{ }\mu\text{s}$

Turn off time when switched from

$I_C = 5\text{ A}; I_B = 0,5\text{ A}$  to  $-V_{BE} = 2,0\text{ V}$   
with  $-I_{BM} = 0,5\text{ A}$

$t_{off}$  typ.  $0,34\text{ }\mu\text{s}$   
<  $1,2\text{ }\mu\text{s}$

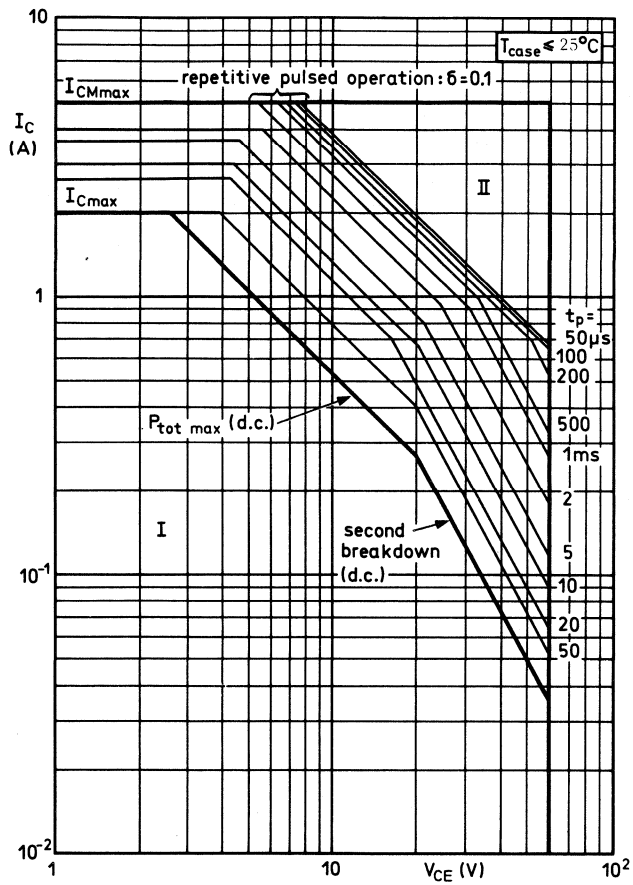

Fig. 2.

Safe Operation Area with the transistor forward biased

I Region of permissible d. c. operation

II Permissible extension for repetitive pulsed operation

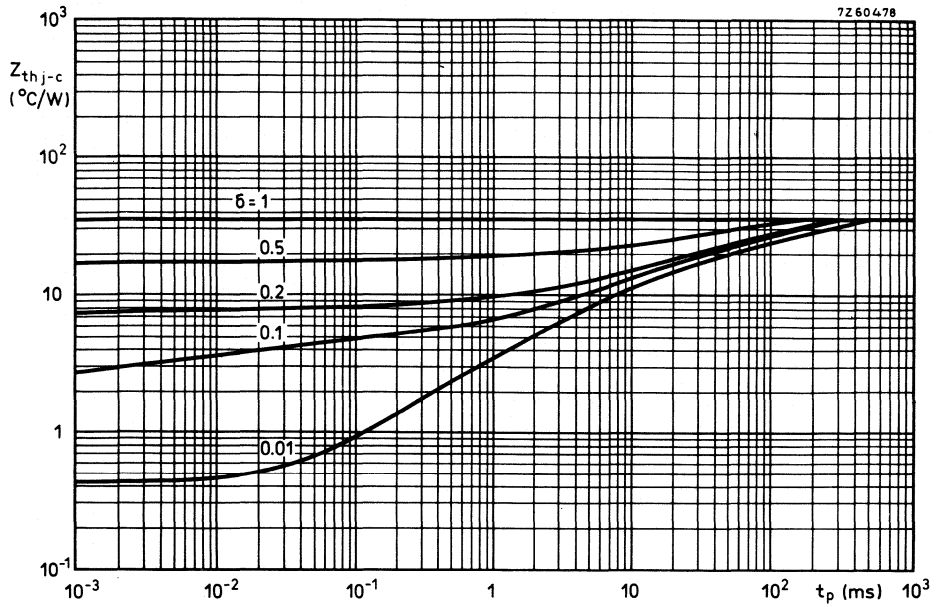

Fig. 3.

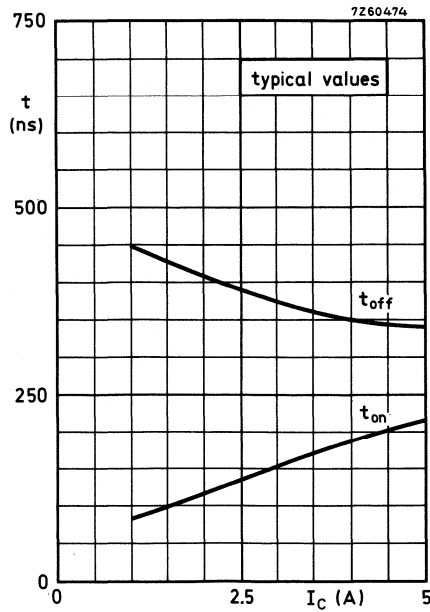

Fig. 4.

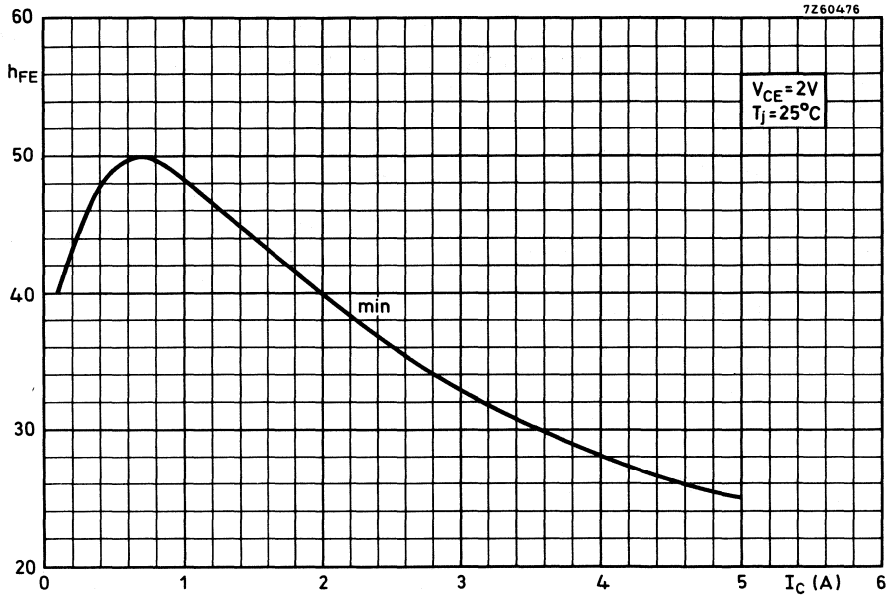

Fig. 5.

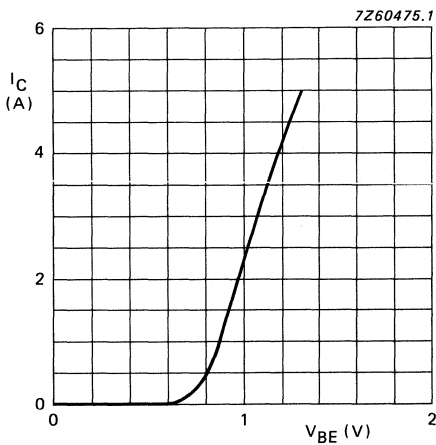

Fig. 6  $V_{CE} = 2V$ ;  $T_j = 25^\circ C$ ;  
typical values.

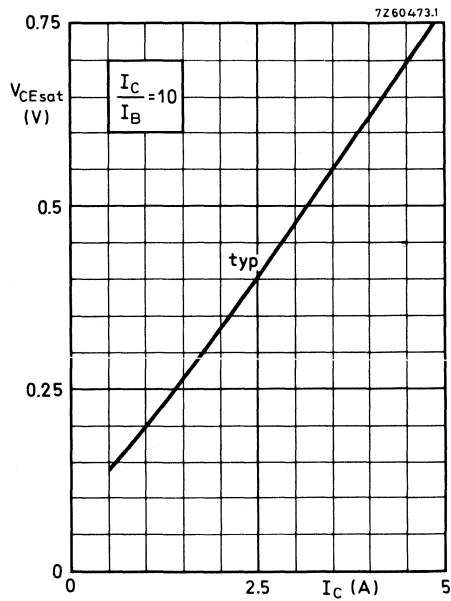

Fig. 7.



## SILICON PLANAR EPITAXIAL TRANSISTORS



NPN transistors in TO-39 metal envelopes for general purpose industrial applications.

### QUICK REFERENCE DATA

			BFX84	BFX85	
Collector-base voltage (open emitter)	$V_{CBO}$	max.	100	100	V
Collector-emitter voltage (open base)	$V_{CEO}$	max.	60	60	V
Collector current (peak value)	$I_{CM}$	max.	1.0	1.0	A
Total power dissipation up to $T_{amb} = 25\text{ }^{\circ}\text{C}$	$P_{tot}$	max.	800	800	mW
Total power dissipation up to $T_{case} = 100\text{ }^{\circ}\text{C}$	$P_{tot}$	max.	2.86	2.86	W
DC current gain $I_C = 150\text{ mA}; V_{CE} = 10\text{ V}$	$h_{FE}$	min.	30	70	
		typ.	112	142	
Transition frequency at $f = 35\text{ MHz}$ $I_C = 50\text{ mA}; V_{CE} = 10\text{ V}; T_{amb} = 25\text{ }^{\circ}\text{C}$	$f_T$	min.	50	50	MHz

### MECHANICAL DATA

Dimensions in mm

Fig.1 TO-39.

Collector connected to case.

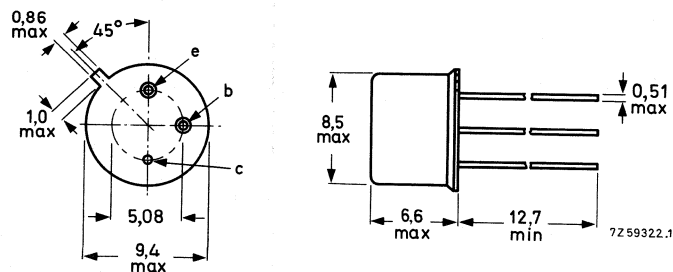

Maximum lead diameter is guaranteed only for 12.7 mm.

RATINGS

Limiting values of operation according to the absolute maximum system.

Electrical

	BFX84	BFX85	
$V_{CBO}$ max.	100	100	V
$V_{CE}$ max. (cut-off, $I_C \leq 1\text{mA}$ )	100	100	V
$V_{CEO}$ max.	60	60	V
$V_{EBO}$ max.		6.0	V
$I_C$ max.		1.0	A
$I_{CM}$ max.		1.0	A
$-I_E$ max.		1.0	A
$-I_{EM}$ max.		1.0	A
$I_B$ max.	100		mA
$\pm I_{BM}$ max.	100		mA
$P_{tot}$ max. $T_{amb} \leq 25^\circ\text{C}$	800		mW
$T_{case} \leq 25^\circ\text{C}$		5.0	W
$T_{case} > 25, < 100^\circ\text{C}$		2.86	W

Temperature

$T_{stg}$	-65 to +150	$^\circ\text{C}$
$T_j$ max.	175	$^\circ\text{C}$

THERMAL CHARACTERISTICS

$R_{th(j-amb)}$ in free air	200	K/W
$R_{th(j-case)}$	35	K/W

## BFX84

ELECTRICAL CHARACTERISTICS ( $T_j = 25^\circ\text{C}$  unless otherwise stated)

		Min.	Typ.	Max.	
$I_{\text{CBO}}$	Collector cut-off current				
	$V_{\text{CB}} = 100\text{V}, I_{\text{E}} = 0$	-	10	500	nA
	$V_{\text{CB}} = 100\text{V}, I_{\text{E}} = 0, T_j = 100^\circ\text{C}$	-	0.5	30	$\mu\text{A}$
	$V_{\text{CB}} = 80\text{V}, I_{\text{E}} = 0$	-	2.0	50	nA
$I_{\text{EBO}}$	Emitter cut-off current				
	$V_{\text{EB}} = 6.0\text{V}, I_{\text{C}} = 0$	-	10	500	nA
	$V_{\text{EB}} = 5.0\text{V}, I_{\text{C}} = 0$	-	2.0	50	nA
$h_{\text{FE}}$	Static forward current transfer ratio				
	$I_{\text{C}} = 10\text{mA}, V_{\text{CE}} = 10\text{V}$	20	80	-	
	$I_{\text{C}} = 150\text{mA}, V_{\text{CE}} = 10\text{V}$	30	112	-	
	$I_{\text{C}} = 500\text{mA}, V_{\text{CE}} = 10\text{V}$	20	70	-	
	$I_{\text{C}} = 1.0\text{A}, V_{\text{CE}} = 10\text{V}$	15	35	-	
$V_{\text{CE(sat)}}$	Collector-emitter saturation voltage				
	$I_{\text{C}} = 10\text{mA}, I_{\text{B}} = 1.0\text{mA}$	-	0.15	0.20	V
	$I_{\text{C}} = 150\text{mA}, I_{\text{B}} = 15\text{mA}$	-	0.15	0.35	V
	$I_{\text{C}} = 500\text{mA}, I_{\text{B}} = 50\text{mA}$	-	0.35	1.00	V
	$I_{\text{C}} = 1.0\text{A}, I_{\text{B}} = 100\text{mA}$	-	0.66	1.60	V
$V_{\text{BE(sat)}}$	Base-emitter saturation voltage				
	$I_{\text{C}} = 10\text{mA}, I_{\text{B}} = 1.0\text{mA}$	-	0.69	1.2	V
	$I_{\text{C}} = 150\text{mA}, I_{\text{B}} = 15\text{mA}$	-	0.92	1.3	V
	$I_{\text{C}} = 500\text{mA}, I_{\text{B}} = 50\text{mA}$	-	1.15	1.5	V
	$I_{\text{C}} = 1.0\text{A}, I_{\text{B}} = 100\text{mA}$	-	1.40	2.0	V
$C_{\text{Tc}}$	Collector capacitance				
	$V_{\text{CB}} = 10\text{V}, I_{\text{E}} = I_{\text{e}} = 0,$ $f = 1.0\text{MHz}$	-	7.0	12	pF

BFX84

ELECTRICAL CHARACTERISTICS (contd.)

		Min.	Typ.	Max.	
$f_T$	Transition frequency $I_C = 50\text{mA}$ , $V_{CE} = 10\text{V}$ , $f = 35\text{MHz}$ , $T_{amb} = 25^\circ\text{C}$	50	140	-	MHz
Saturated switching times					
$I_C = 150\text{mA}$ , $I_{B(on)} = -I_{B(off)} = 15\text{mA}$ , $-V_{EE} = 10\text{V}$ , $-V_{BE(off)} = 2.0\text{V}$					
$t_d$	Delay time	-	15	-	ns
$t_r$	Rise time	-	40	-	ns
$t_{on}$	Turn-on time	-	55	-	ns
$t_s$	Storage time	-	300	-	ns
$t_f$	Fall time	-	60	-	ns
$t_{off}$	Turn-off time	-	360	-	ns
h-parameters					
$h_{fe}$	$I_C = 1.0\text{mA}$ , $V_{CE} = 5.0\text{V}$ , $f = 1.0\text{kHz}$ , $T_{amb} = 25^\circ\text{C}$	10	65	-	
$h_{ie}$	$I_C = 10\text{mA}$ , $V_{CE} = 5.0\text{V}$ , $f = 1.0\text{kHz}$ , $T_{amb} = 25^\circ\text{C}$	-	750	-	$\Omega$
$h_{re}$		-	0.85	5.0	$\times 10^{-4}$
$h_{fe}$		15	80	-	
$h_{oe}$		-	35	80	$\mu\text{mho}$

**BFX85**ELECTRICAL CHARACTERISTICS ( $T_j = 25^\circ\text{C}$  unless otherwise stated)

		Min.	Typ.	Max.	
$I_{CBO}$	Collector cut-off current				
	$V_{CB} = 100\text{V}, I_E = 0$	-	10	500	nA
	$V_{CB} = 100\text{V}, I_E = 0, T_j = 100^\circ\text{C}$	-	0.5	30	$\mu\text{A}$
	$V_{CB} = 80\text{V}, I_E = 0$	-	2.0	50	nA
$I_{EBO}$	Emitter cut-off current				
	$V_{EB} = 6.0\text{V}, I_C = 0$	-	10	500	nA
	$V_{EB} = 5.0\text{V}, I_C = 0$	-	2.0	50	nA
$h_{FE}$	Static forward current transfer ratio				
	$I_C = 10\text{mA}, V_{CE} = 10\text{V}$	50	90	-	
	$I_C = 150\text{mA}, V_{CE} = 10\text{V}$	70	142	-	
	$I_C = 500\text{mA}, V_{CE} = 10\text{V}$	30	90	-	
$V_{CE(sat)}$	Collector-emitter saturation voltage				
	$I_C = 10\text{mA}, I_B = 1.0\text{mA}$	-	0.15	0.20	V
	$I_C = 150\text{mA}, I_B = 15\text{mA}$	-	0.15	0.35	V
	$I_C = 500\text{mA}, I_B = 50\text{mA}$	-	0.35	1.00	V
$V_{BE(sat)}$	Base-emitter saturation voltage				
	$I_C = 10\text{mA}, I_B = 1.0\text{mA}$	-	0.69	1.2	V
	$I_C = 150\text{mA}, I_B = 15\text{mA}$	-	0.92	1.3	V
	$I_C = 500\text{mA}, I_B = 50\text{mA}$	-	1.15	1.5	V
$C_{Tc}$	Collector capacitance				
	$V_{CB} = 10\text{V}, I_E = I_e = 0,$ $f = 1.0\text{MHz}$	-	7.0	12	pF

BFX85

ELECTRICAL CHARACTERISTICS (contd.)

		Min.	Typ.	Max.	
$f_T$	Transition frequency $I_C = 50\text{mA}$ , $V_{CE} = 10\text{V}$ , $f = 35\text{MHz}$ , $T_{amb} = 25^\circ\text{C}$	50	185	-	MHz

Saturated switching times

$$I_C = 150\text{mA}, I_{B(\text{on})} = -I_{B(\text{off})} = 15\text{mA},$$

$$-V_{EE} = 10\text{V}, -V_{BE(\text{off})} = 2.0\text{V}$$

$t_d$	Delay time	-	15	-	ns
$t_r$	Rise time	-	40	-	ns
$t_{\text{on}}$	Turn-on time	-	55	-	ns
$t_s$	Storage time	-	300	-	ns
$t_f$	Fall time	-	60	-	ns
$t_{\text{off}}$	Turn-off time	-	360	-	ns

h-parameters

$h_{fe}$	$I_C = 1.0\text{mA}$ , $V_{CE} = 5.0\text{V}$ , $f = 1.0\text{kHz}$ , $T_{amb} = 25^\circ\text{C}$	20	65	-	
$h_{ie}$	$I_C = 10\text{mA}$ , $V_{CE} = 5.0\text{V}$ , $f = 1.0\text{kHz}$ , $T_{amb} = 25^\circ\text{C}$	-	750	-	$\Omega$
$h_{re}$		-	0.85	-	$5.0 \times 10^{-4}$
$h_{fe}$		25	80	-	
$h_{oe}$		-	35	80	$\mu\text{mho}$

MEASUREMENT OF SATURATED SWITCHING TIMES

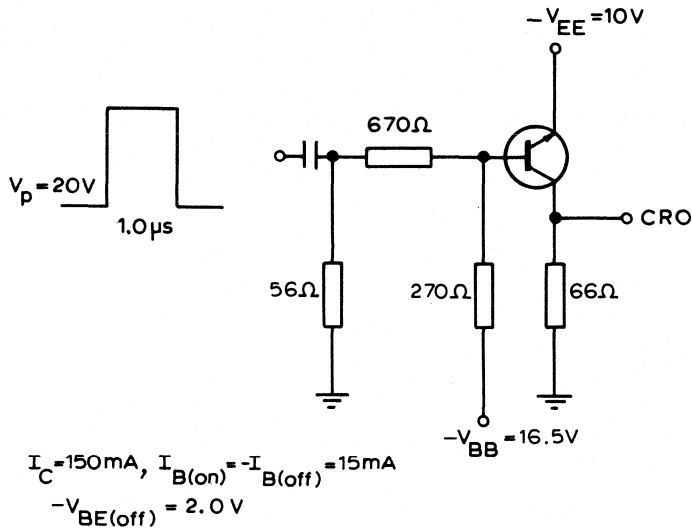

Fig.2 Test circuit.

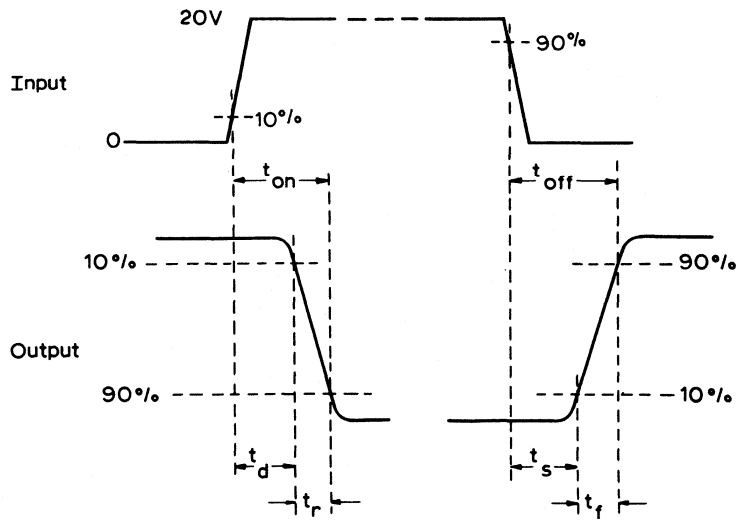

Fig.3 Switching waveforms.

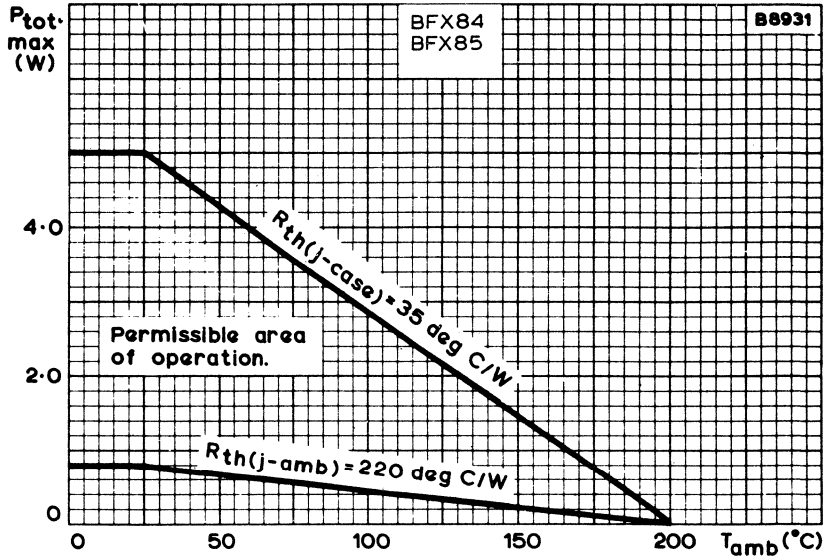

Fig.4 Maximum total dissipation plotted against ambient temperature.

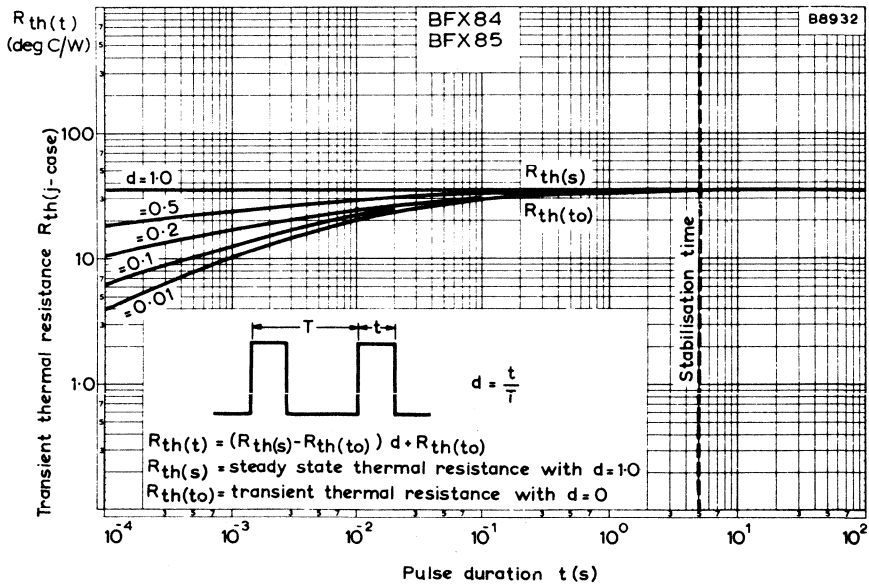

Fig.5 Transient thermal resistance for various duty factors plotted against pulse duration.



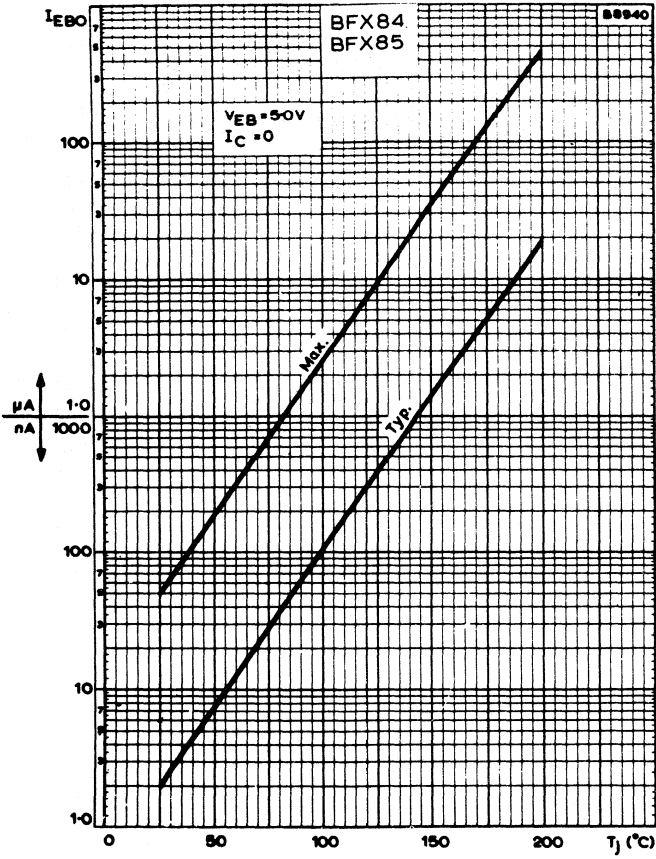

Fig.6 Collector and emitter cut-off currents plotted against junction temperature.

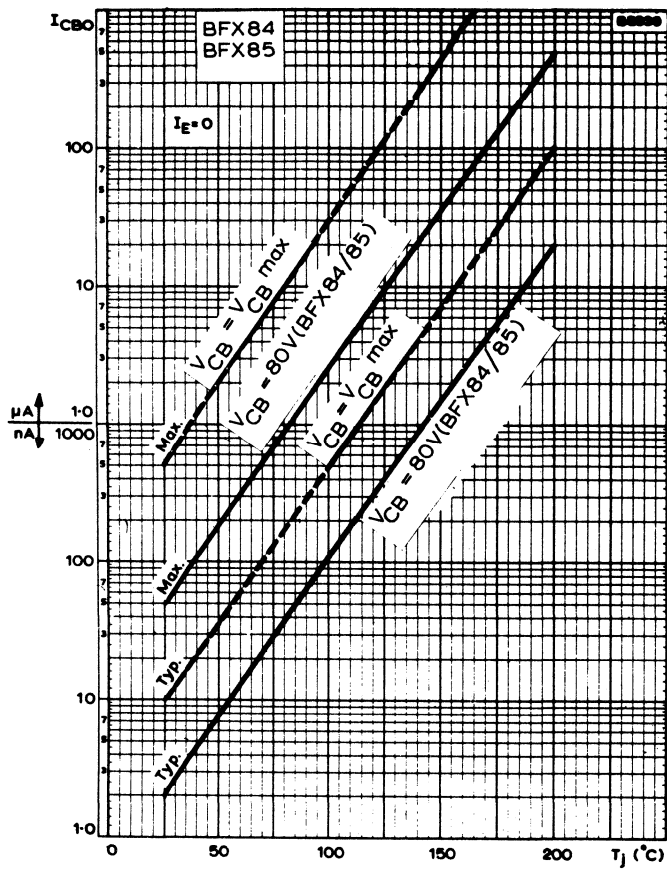

Fig.7 Collector and emitter cut-off currents plotted against junction temperature.

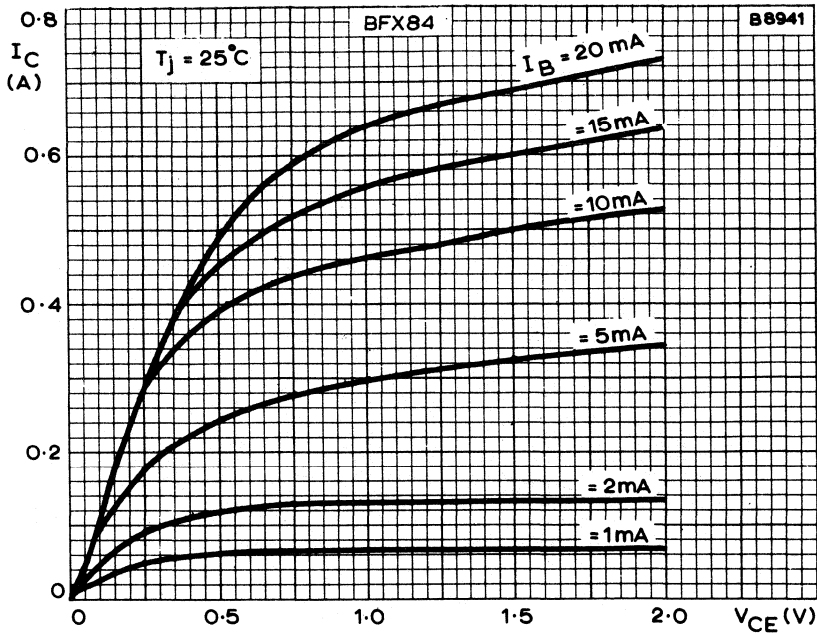

Fig.8 Typical output characteristics.

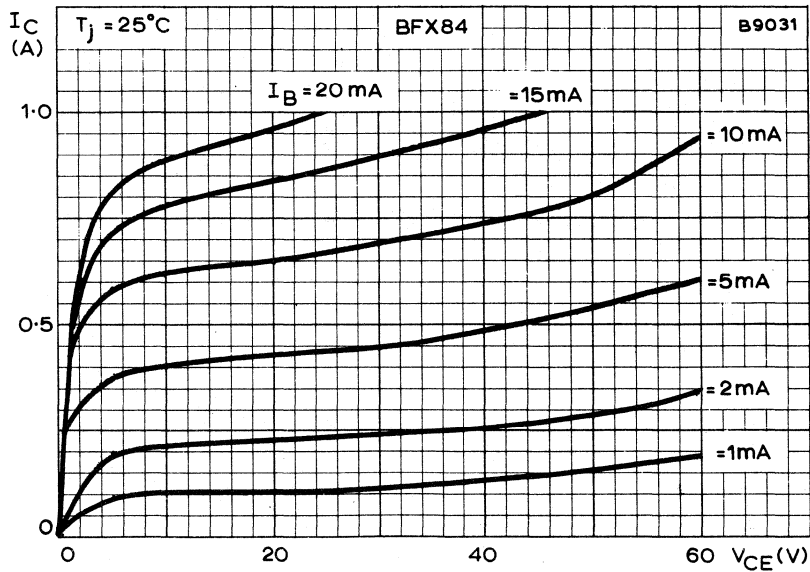

Fig.9 Typical output characteristics.

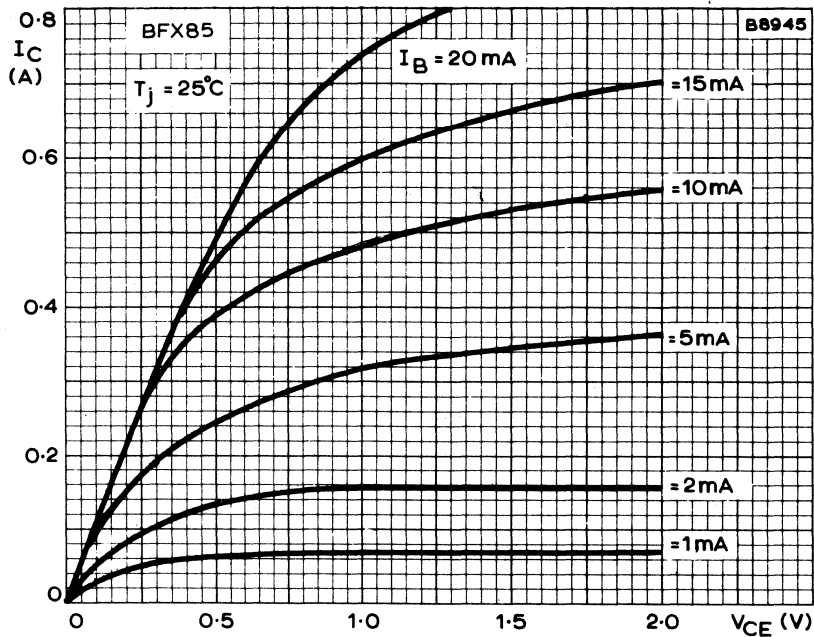

Fig.10 Typical output characteristics.

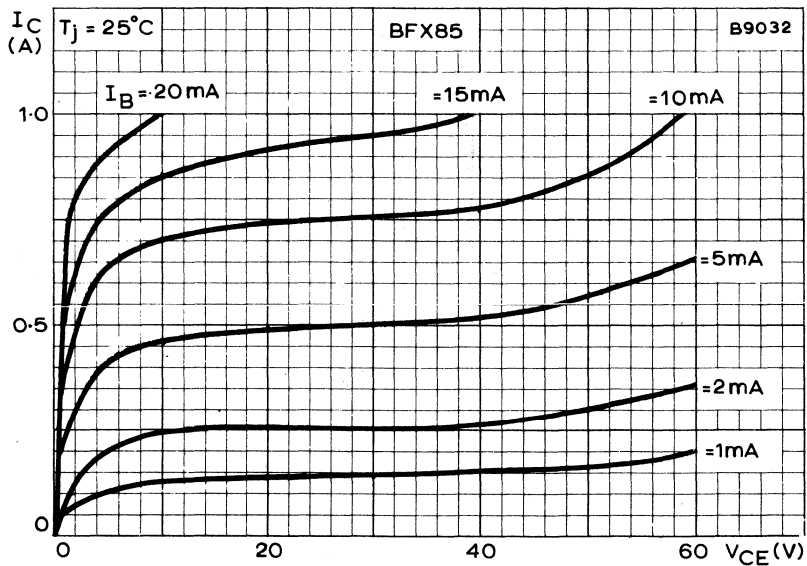

Fig.11 Typical output characteristics.

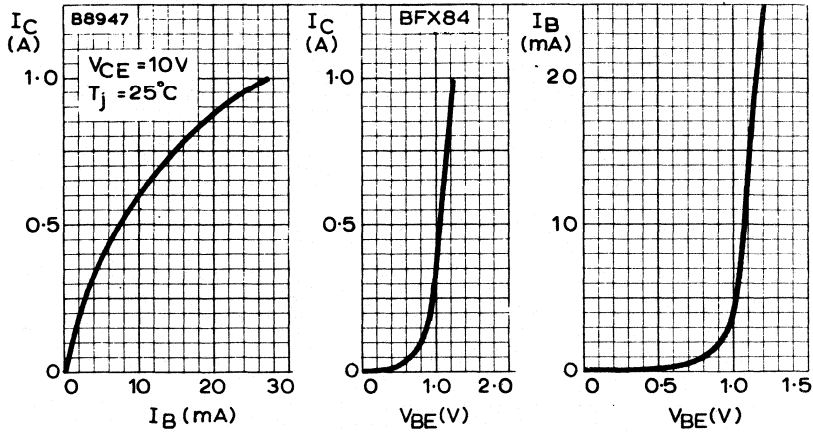

Fig.12 Typical transfer, mutual and input characteristics.

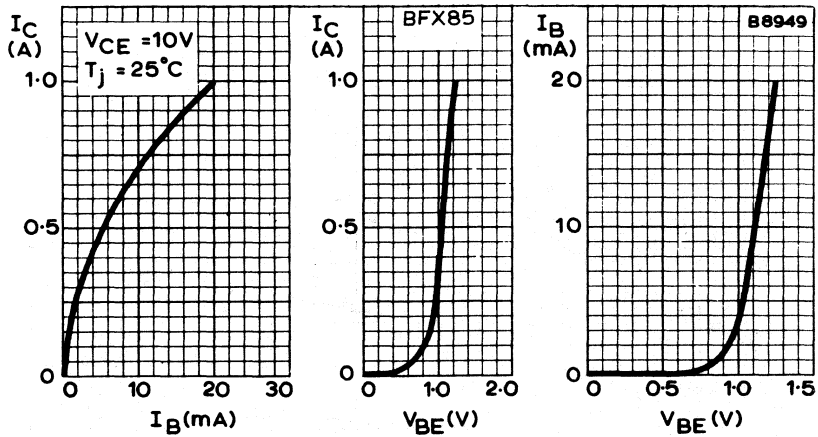

Fig.13 Typical transfer, mutual and input characteristics.

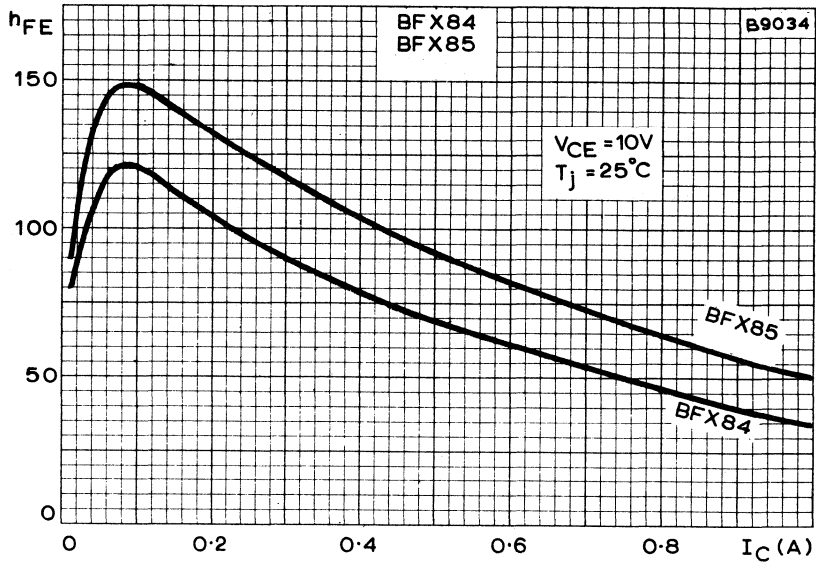

Fig.14 Typical static forward current transfer ratio plotted against collector current and junction temperature.

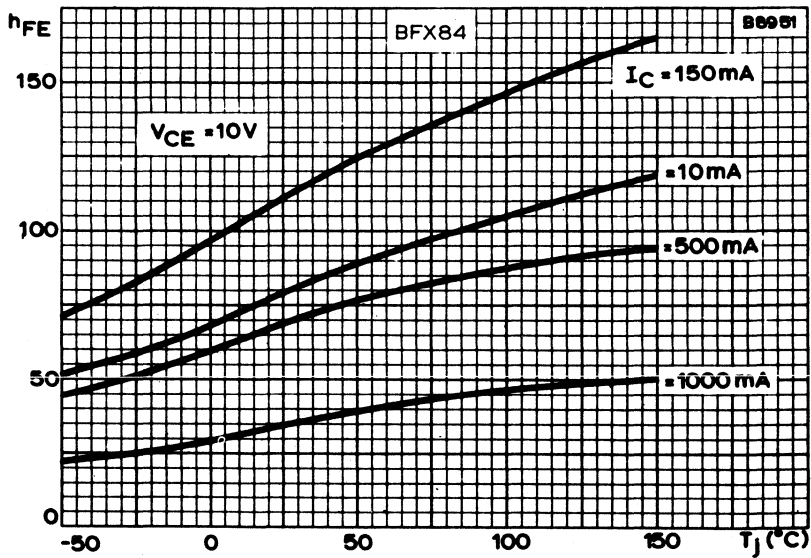

Fig.15 Typical static forward current transfer ratio plotted against collector current and junction temperature.

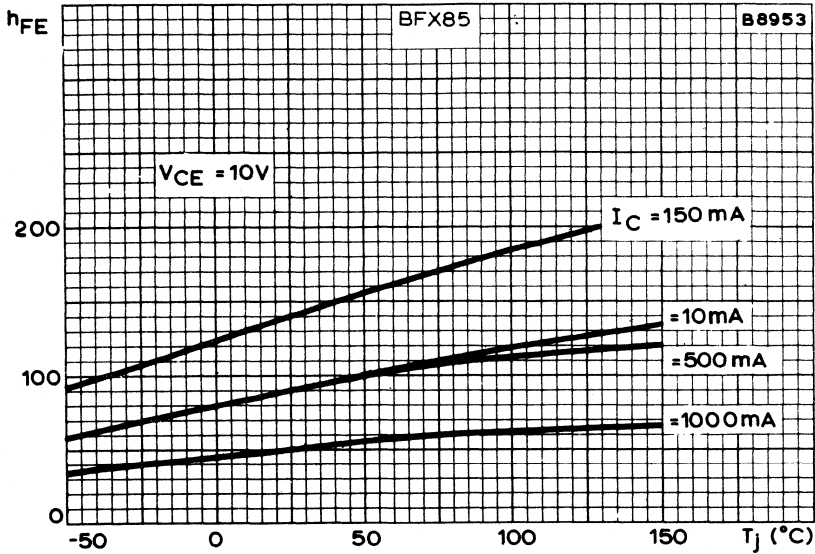

Fig.16 Typical static forward current transfer ratio plotted against junction temperature.

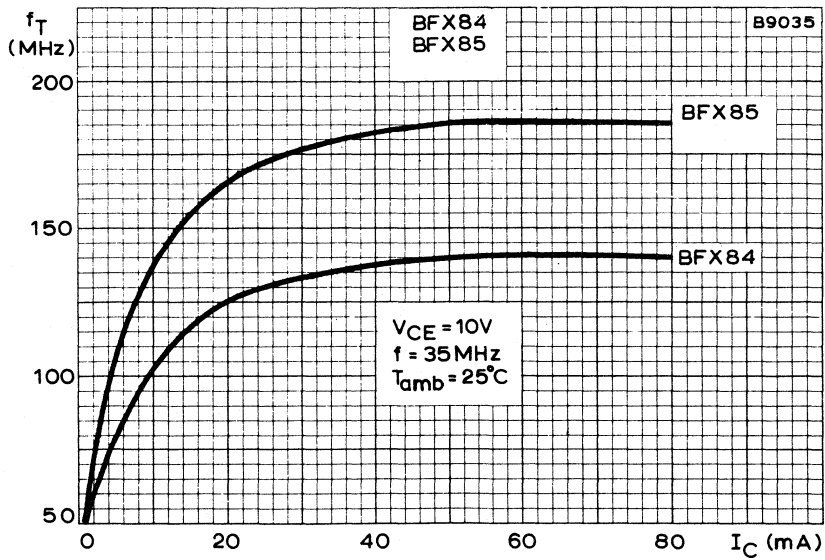

Fig.17 Typical transition frequency plotted against collector current.

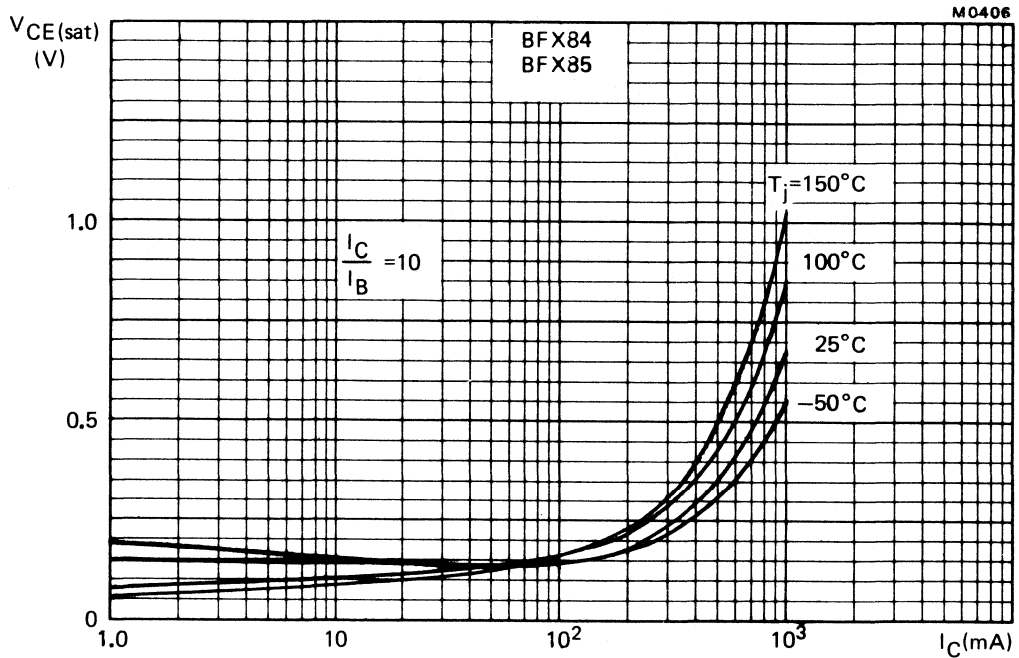

Fig.18 Typical collector-emitter saturation voltage plotted against collector current.

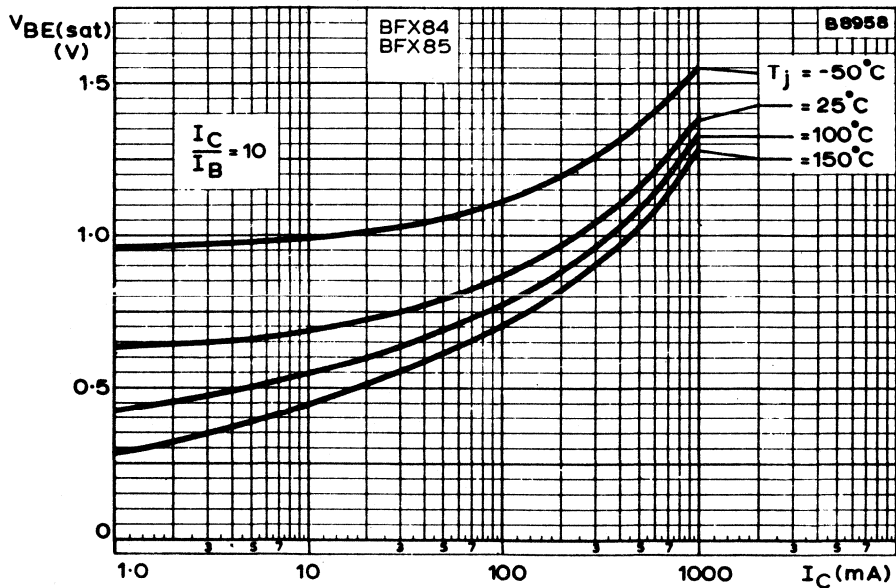

Fig.19 Typical base-emitter saturation voltage plotted against collector current.



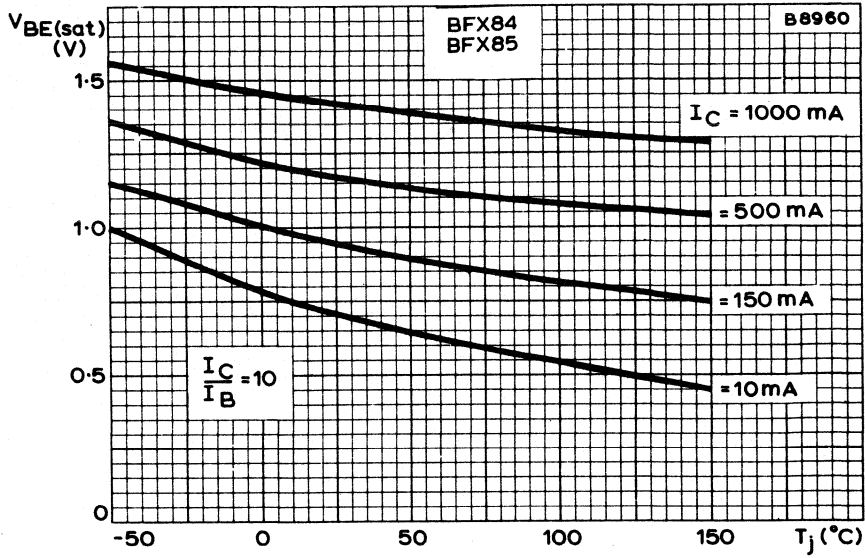

Fig.20 Typical base-emitter saturation voltage plotted against junction temperature.

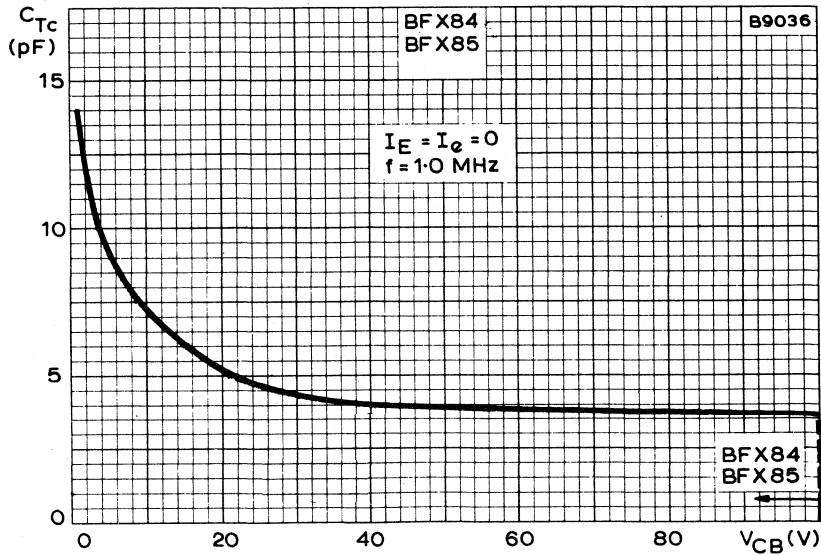

Fig.21 Typical collector capacitance plotted against collector-base voltage.

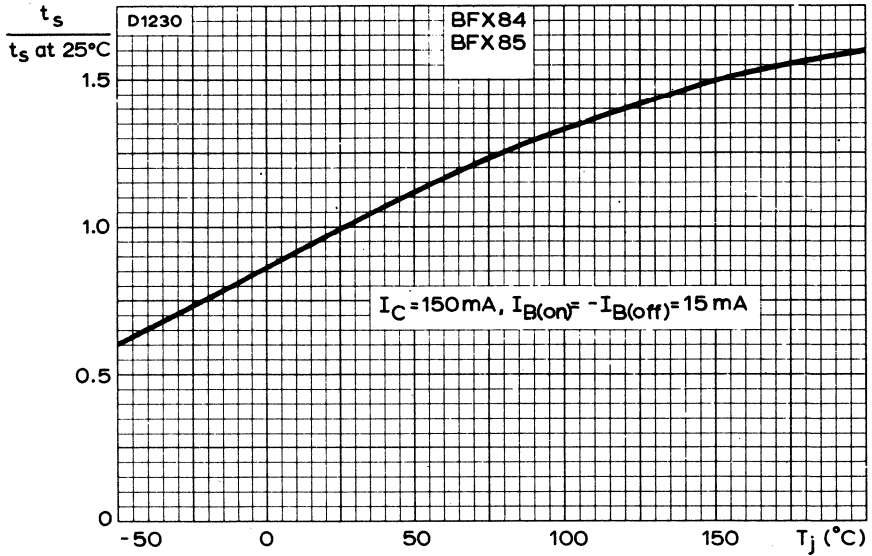

Fig.22 Typical storage time normalised at 25 °C.

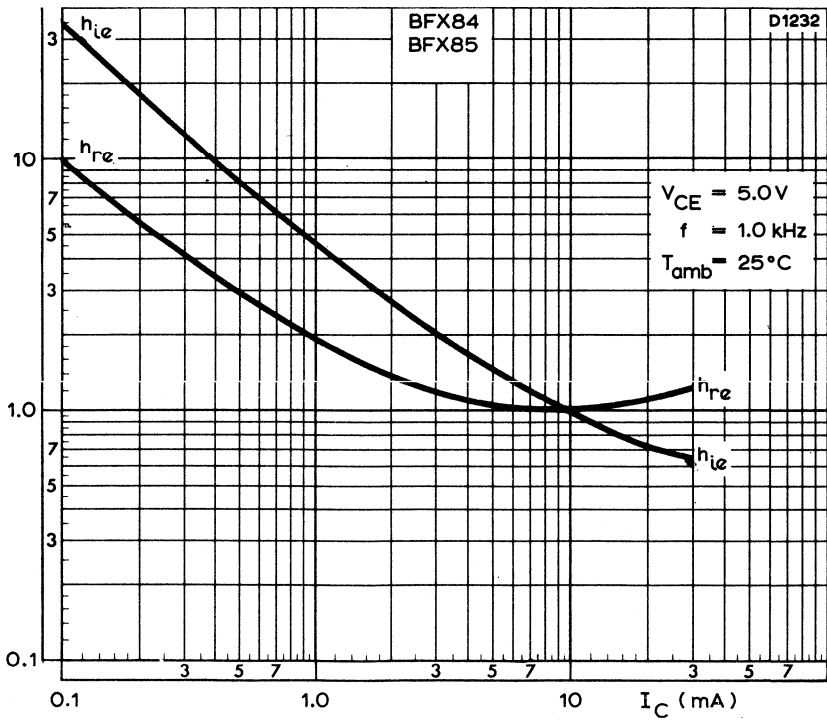

Fig.23.

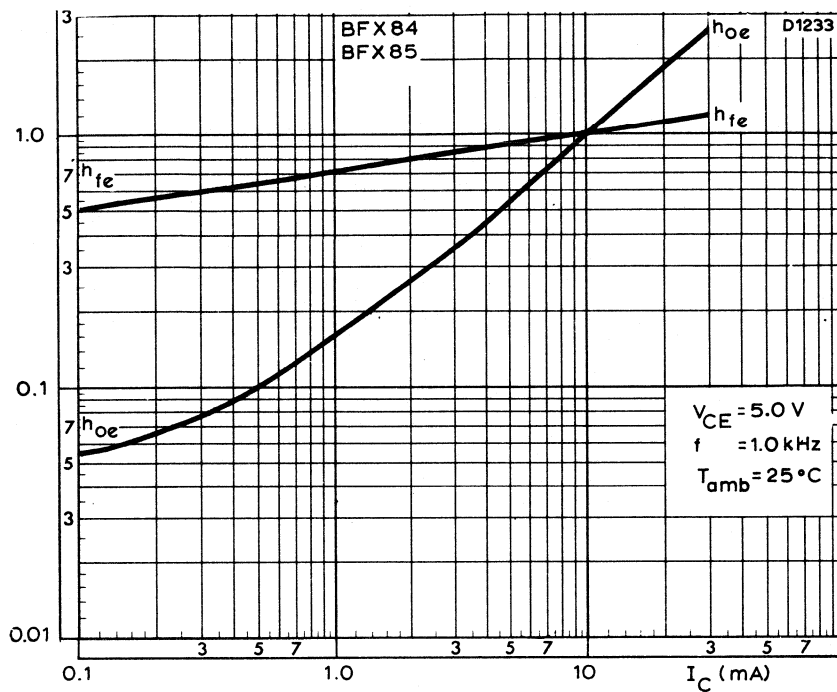

Fig.24 Typical h-parameters normalised at  $I_C = 10$  mA.



SILICON PLANAR EPITAXIAL TRANSISTORS



PNP transistors in TO-39 metal envelopes for general industrial applications.

QUICK REFERENCE DATA

		BFX87	BFX88
Collector-base voltage (open emitter)	$-V_{CBO}$	max. 50	40 V
Collector-emitter voltage (open base)	$-V_{CEO}$	max. 50	40 V
Collector current (peak value)	$-I_{CM}$	max. 600	600 mA
Total power dissipation up to $T_{amb} = 25\text{ }^{\circ}\text{C}$	$P_{tot}$	max. 600	600 mW
DC current gain	$h_{FE}$	min. 40	40
		typ. 125	125
Transition frequency at $f = 100\text{ MHz}$	$f_T$	min. 100	100 MHz

MECHANICAL DATA

Dimensions in mm

Fig.1 TO-39.

Collector connected to case

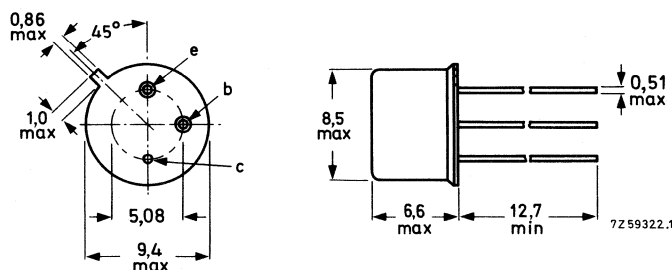

Maximum lead diameter is guaranteed only for 12.7 mm.

**RATINGS**

Limiting values in accordance with the Absolute Maximum System (IEC 134)

			<b>BFX87</b>	<b>BFX88</b>	
Collector-base voltage (open emitter)	$-V_{CBO}$	max.	50	40	V
Collector-emitter voltage (open base)	$-V_{CEO}$	max.	50	40	V
Collector current (DC)	$-I_C$	max.	600		mA
Collector current (peak value)	$-I_{CM}$	max.	600		mA
Emitter current	$I_{EM}$	max.	600		mA
Total power dissipation up to $T_{amb} = 25\text{ }^\circ\text{C}$	$P_{tot}$	max.	600		mW
Storage temperature range	$T_{stg}$		-65 to +150		$^\circ\text{C}$
Junction temperature	$T_j$	max.	+200		$^\circ\text{C}$

**THERMAL RESISTANCE**

From junction to ambient in free air	$R_{th\ j-a}$	=	300		K/W
--------------------------------------	---------------	---	-----	--	-----

**CHARACTERISTICS**

			<b>BFX87</b>	<b>BFX88</b>	
Collector cut-off current $-V_{CB} = 50\text{ V}; I_E = 0$	$-I_{CBO}$	typ.	1.0	—	nA
		max.	500	—	nA
$-V_{CB} = 40\text{ V}; I_E = 0$	$-I_{CBO}$	typ.	0.5	1.0	nA
		max.	50	500	nA
$-V_{CB} = 30\text{ V}; I_E = 0$	$-I_{CBO}$	typ.	—	0.5	nA
		max.	—	50	nA
$-V_{CB} = 40\text{ V}; I_E = 0; T_j = 100\text{ }^\circ\text{C}$	$-I_{CBO}$	typ.	0.03	—	$\mu\text{A}$
		max.	2.0	—	$\mu\text{A}$
$-V_{CB} = 30\text{ V}; I_E = 0; T_j = 100\text{ }^\circ\text{C}$	$-I_{CBO}$	typ.	—	0.03	$\mu\text{A}$
		max.	—	2.0	$\mu\text{A}$
Emitter cut-off current $-V_{EB} = 4.0\text{ V}; I_C = 0$	$-I_{EBO}$	typ.	2.0		nA
		max.	500		nA
$-V_{EB} = 3.0\text{ V}; I_C = 0$	$-I_{EBO}$	typ.	1.0		nA
		max.	100		nA

DC current gain				
$-I_C = 1.0 \text{ mA}; -V_{CE} = 10 \text{ V}$	$h_{FE}$	min.	40	
		typ.	105	
$-I_C = 10 \text{ mA}; -V_{CE} = 10 \text{ V}$	$h_{FE}$	min.	40	
		typ.	125	
$-I_C = 150 \text{ mA}; -V_{CE} = 10 \text{ V}$	$h_{FE}$	min.	40	
		typ.	90	
$-I_C = 500 \text{ mA}; -V_{CE} = 10 \text{ V}$	$h_{FE}$	min.	25	
		typ.	40	
Collector-emitter saturation voltage				
$-I_C = 150 \text{ mA}; -I_B = 15 \text{ mA}$	$-V_{CE(sat)}$	typ.	0.15	V
		max.	0.40	V
Base-emitter saturation voltage				
$-I_C = 30 \text{ mA}; -I_B = 1.0 \text{ mA}$	$-V_{BE(sat)}$	typ.	0.77	V
		max.	0.90	V
$-I_C = 150 \text{ mA}; -I_B = 15 \text{ mA}$	$-V_{BE(sat)}$	typ.	1.05	V
		max.	1.30	V
Collector capacitance				
$-V_{CB} = 10 \text{ V}; I_E = I_e = 0; f = 1.0 \text{ MHz}$	$C_c$	typ.	6.0	pF
		max.	12	pF
Emitter capacitance				
$-V_{EB} = 2.0 \text{ V}; I_C = I_c = 0; f = 1.0 \text{ MHz}$	$C_e$	typ.	18	pF
		max.	30	pF
Transition frequency				
$-I_C = 50 \text{ mA}; -V_{CE} = 10 \text{ V}; f = 100 \text{ MHz};$ $T_{amb} = 25 \text{ }^\circ\text{C}$	$f_T$	min.	100	MHz
		typ.	360	MHz
<b>Saturated switching times</b>				
Turn-on time	$t_{on}$	typ.	25	ns
		max.	60	ns
Turn-off time	$t_{off}$	typ.	55	ns
		max.	150	ns
<b>h-parameters</b>				
Measured at $-I_C = 10 \text{ mA}; -V_{CE} = 10 \text{ V}; f = 1.0 \text{ kHz}; T_{amb} = 25 \text{ }^\circ\text{C}$				
Input impedance	$h_{ie}$	typ.	600	$\Omega$
Voltage feedback ratio	$h_{re}$	typ.	$1.50 \times 10^{-4}$	
Forward current transfer ratio	$h_{fe}$	typ.	155	
Output admittance	$h_{oe}$	typ.	104	$\mu\text{mho}$

TEST CIRCUITS

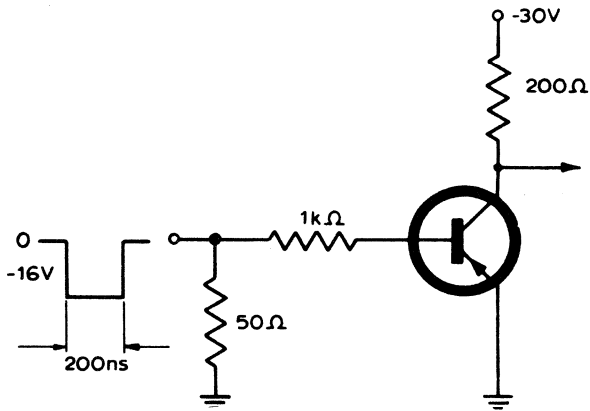

Fig.2 Saturated turn-on switching time.

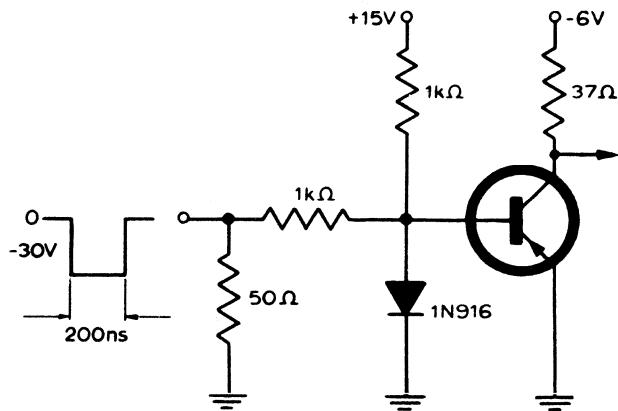

Fig.3 Saturated turn-off switching time.



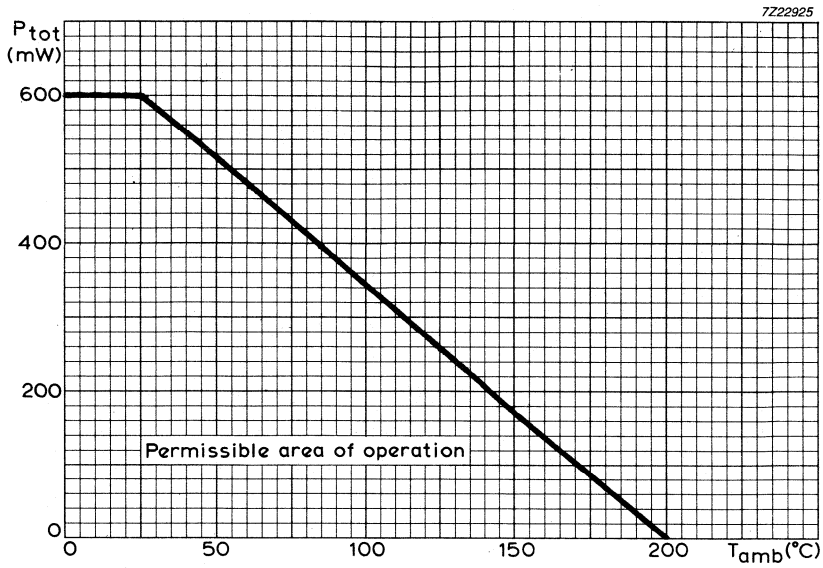

Fig.4 Maximum total dissipation plotted against ambient temperature.

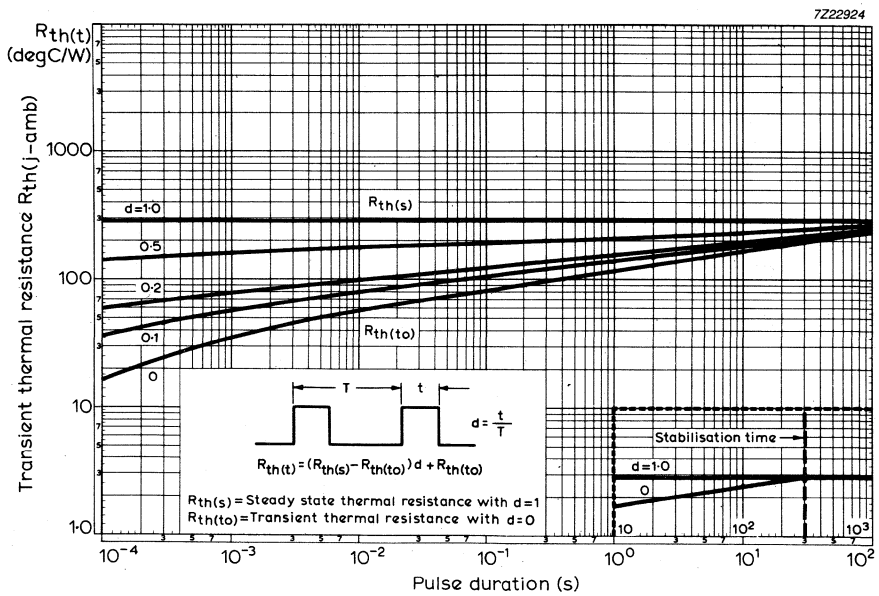

Fig.5 Transient thermal resistance for various duty factors plotted against pulse duration.

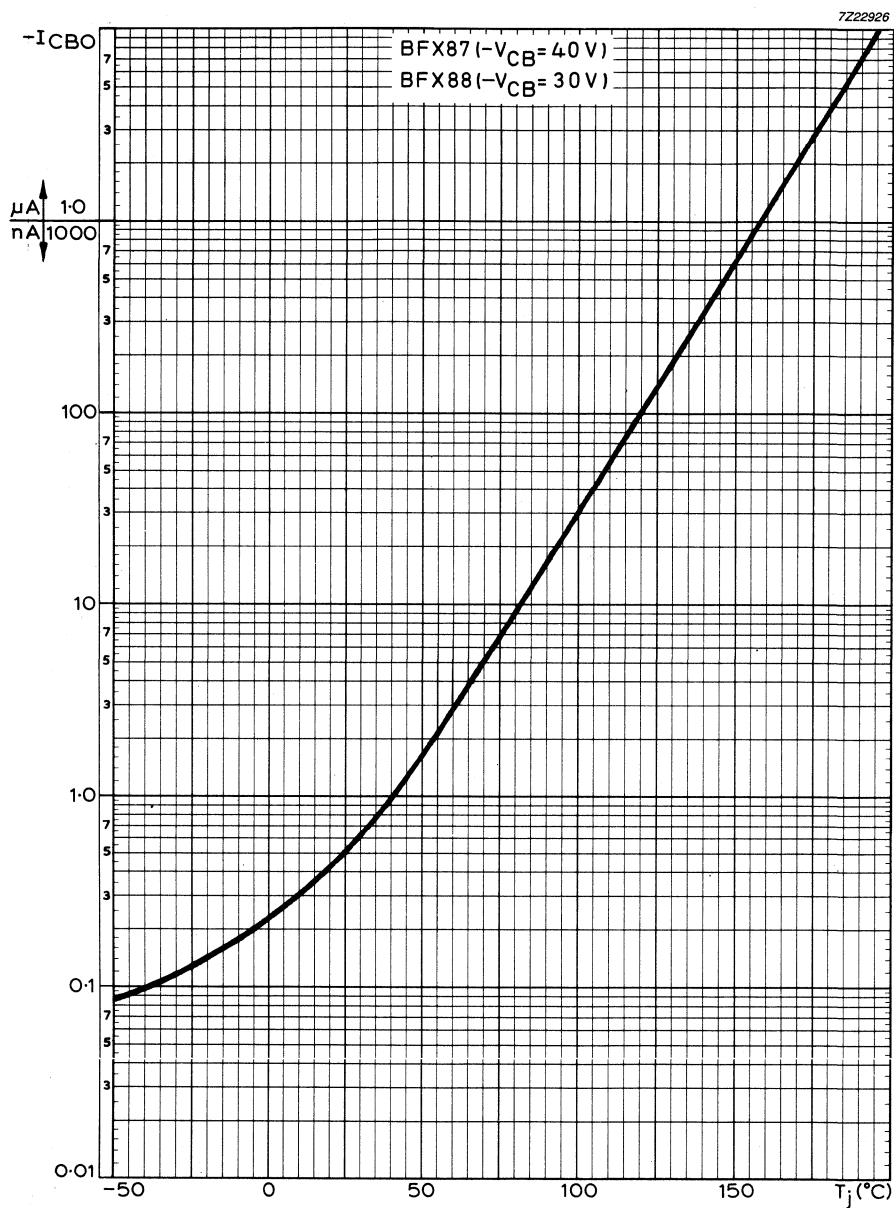

Fig.6 Typical variation of collector cut-off current with junction temperature.

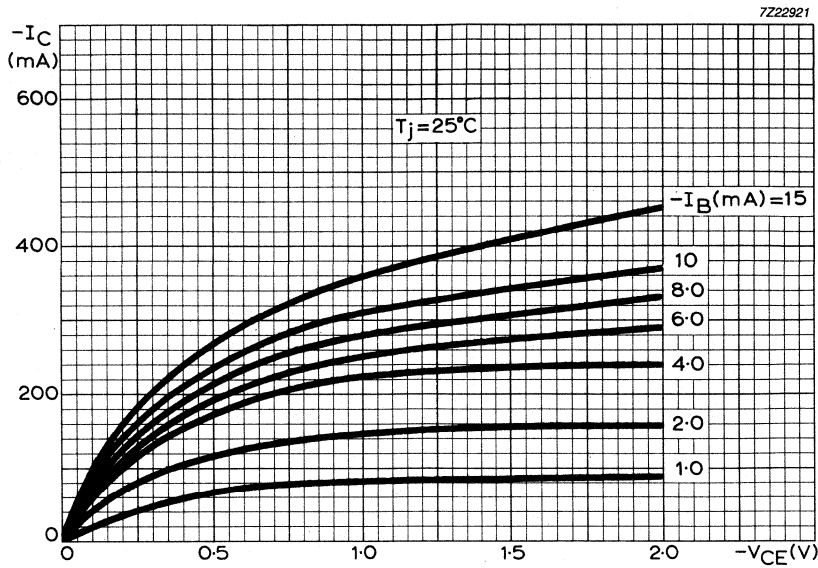

Fig.7 Typical output characteristics at low collector-emitter voltages.

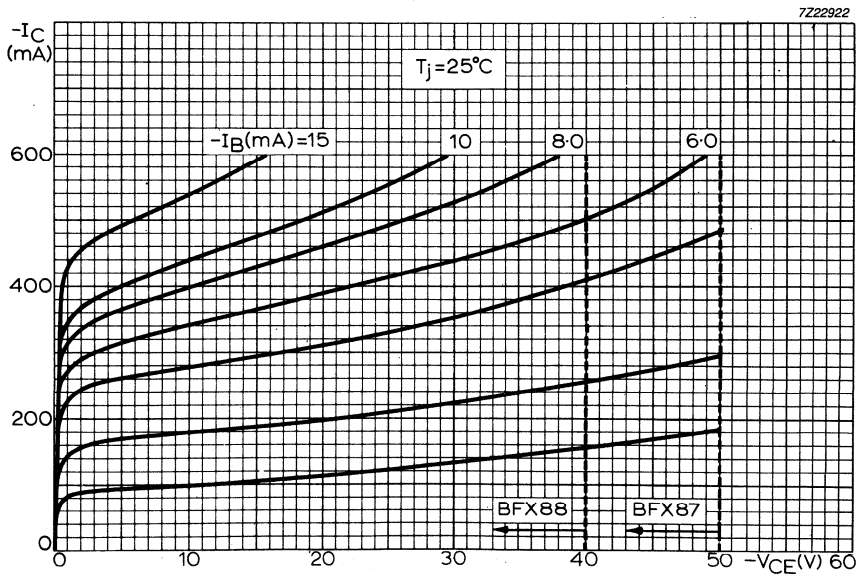

Fig.8 Typical output characteristics at high collector-emitter voltages.

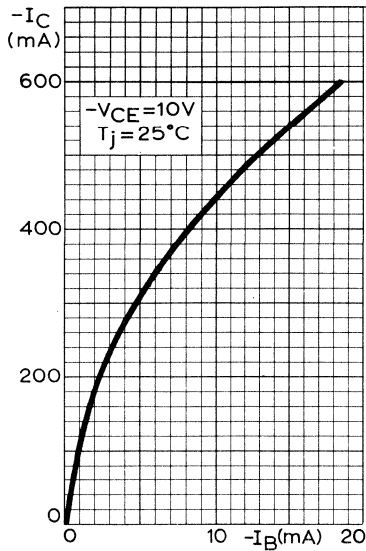

Fig. 9 Typical transfer characteristic.

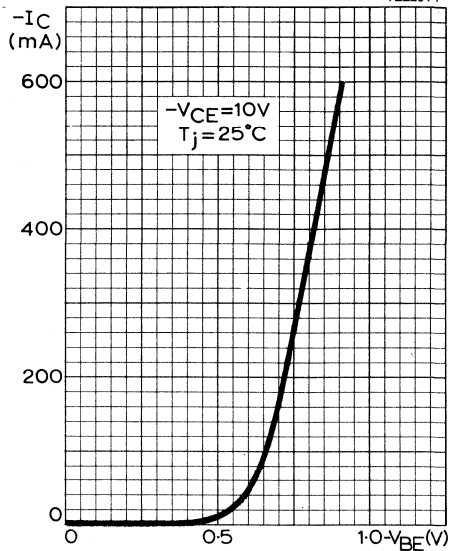

Fig. 10 Typical mutual characteristic.

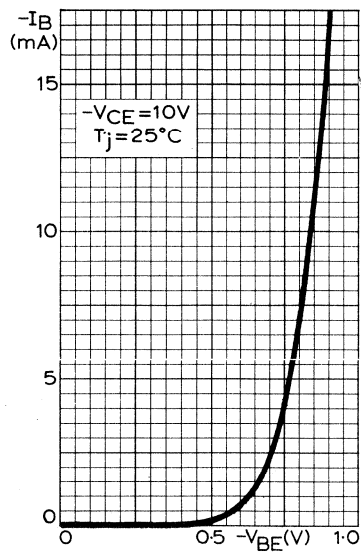

Fig. 11 Typical input characteristic.

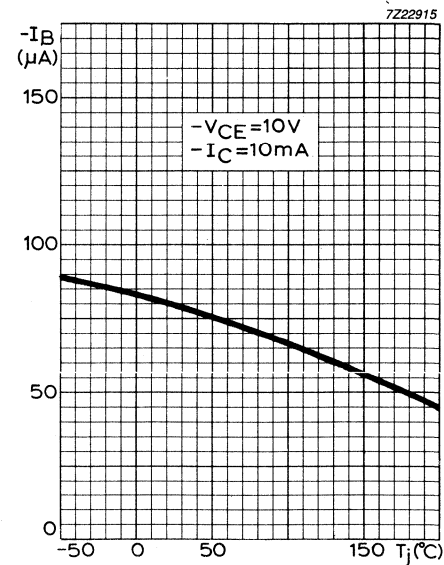

Fig. 12 Typical base current as a function of junction temperature.

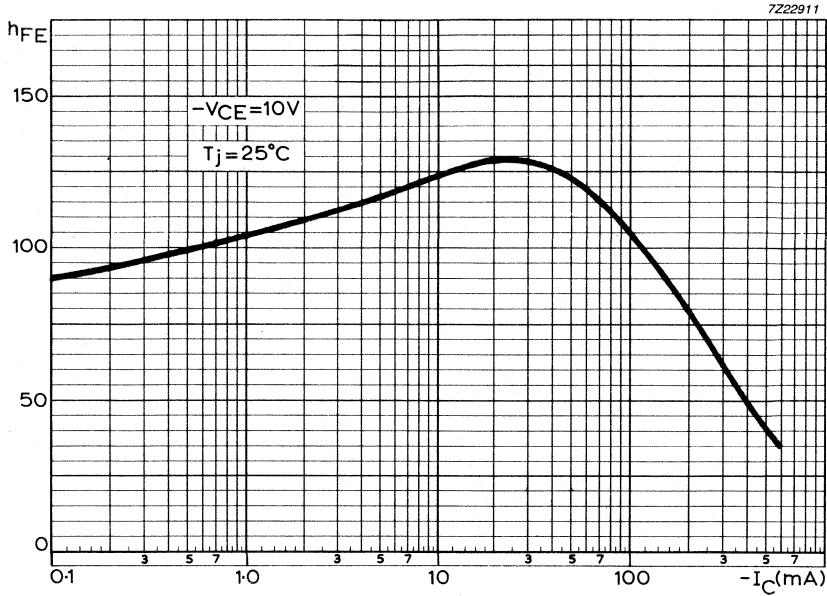

Fig.13 Typical variation of DC current gain with collector current.

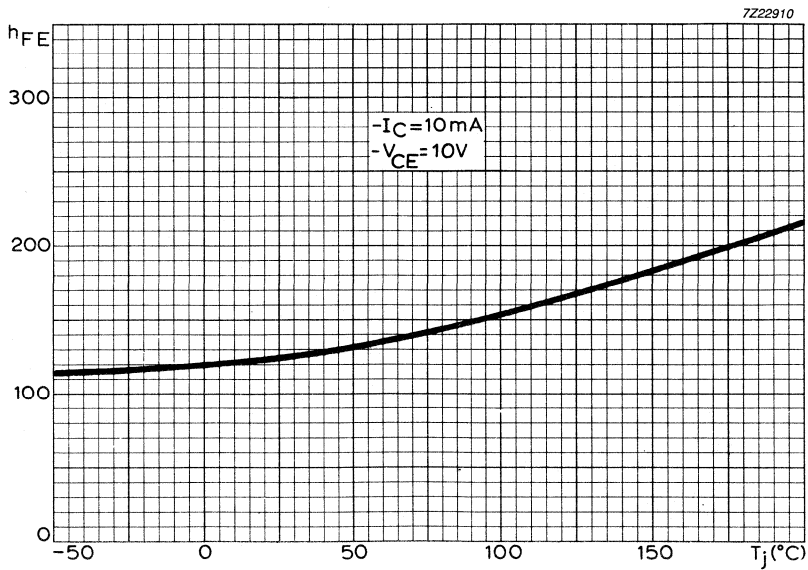

Fig.14 Typical variation of DC current gain with junction temperature.

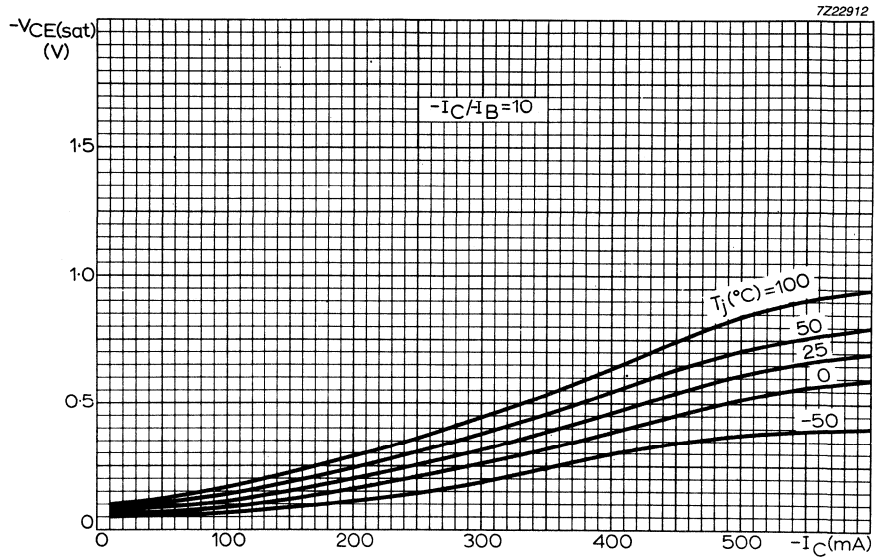

Fig.15 Typical variation of collector-emitter saturation voltage with collector current.

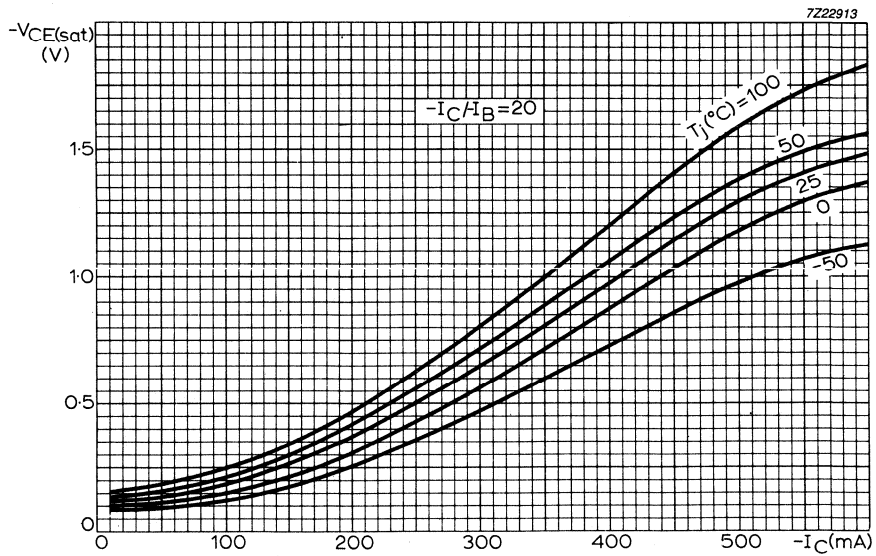

Fig.16 Typical variation of collector-emitter saturation voltage with collector current.

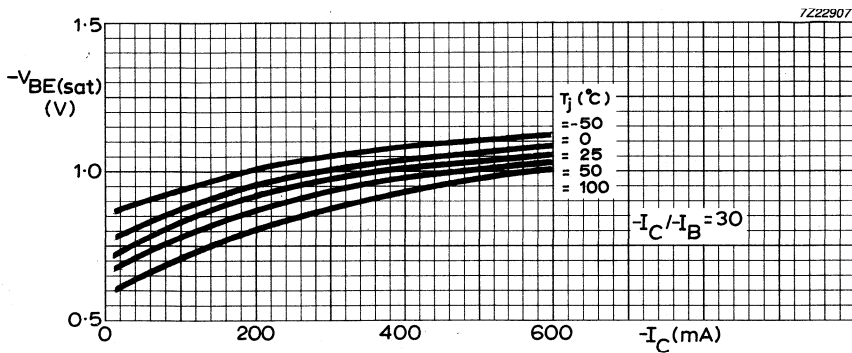
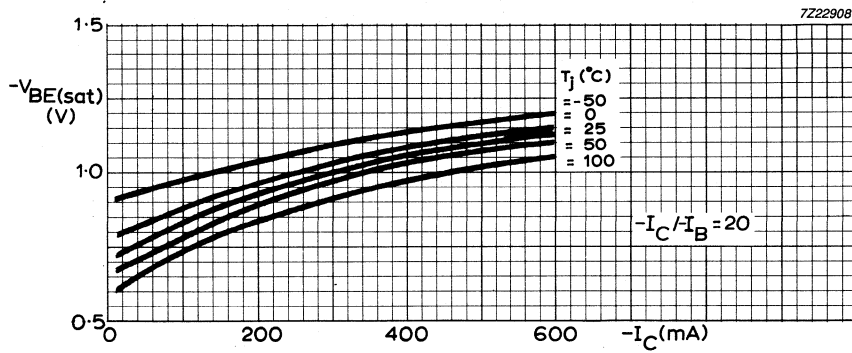
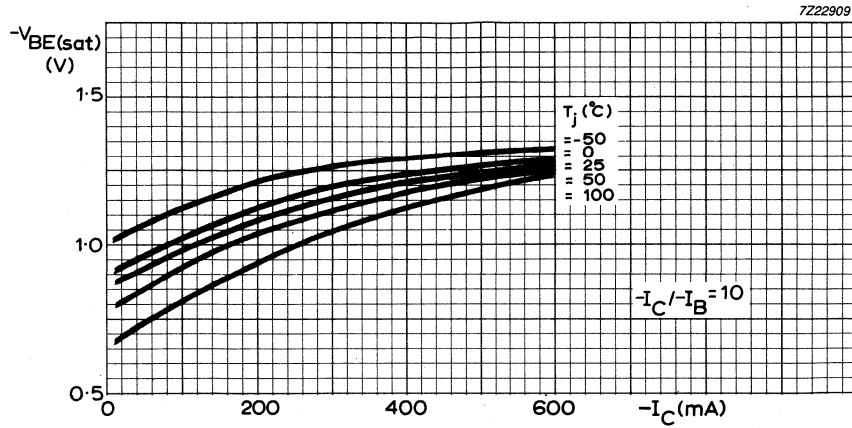

Fig.17 Typical variation of base-emitter saturation voltage with collector current.

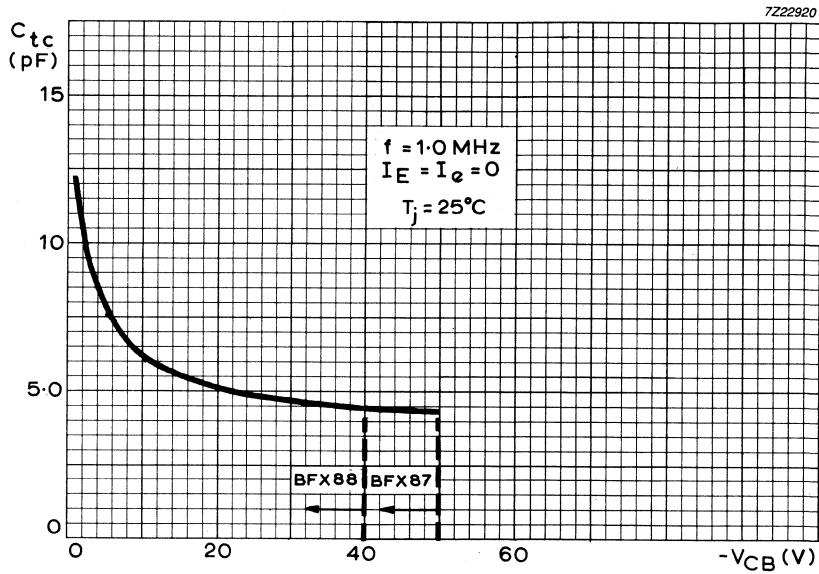

Fig.18 Typical variation of collector capacitance with collector-base voltage.

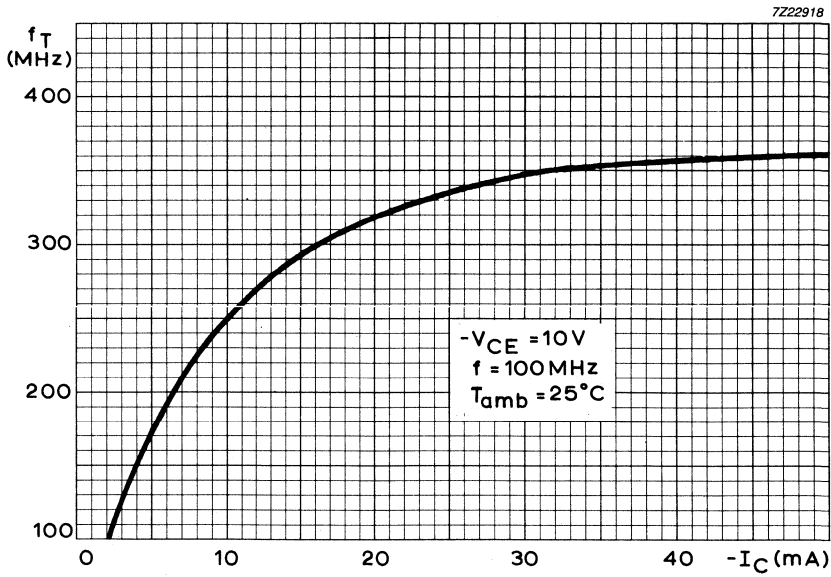

Fig.19 Typical variation of transition frequency with collector current.



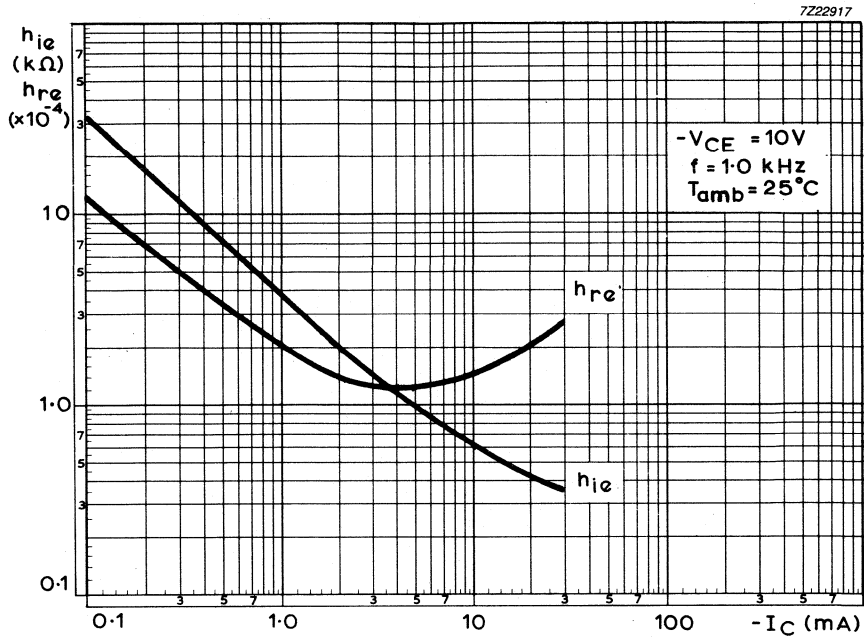

Fig.20 Typical input impedance and typical voltage feedback ratio plotted against collector current.

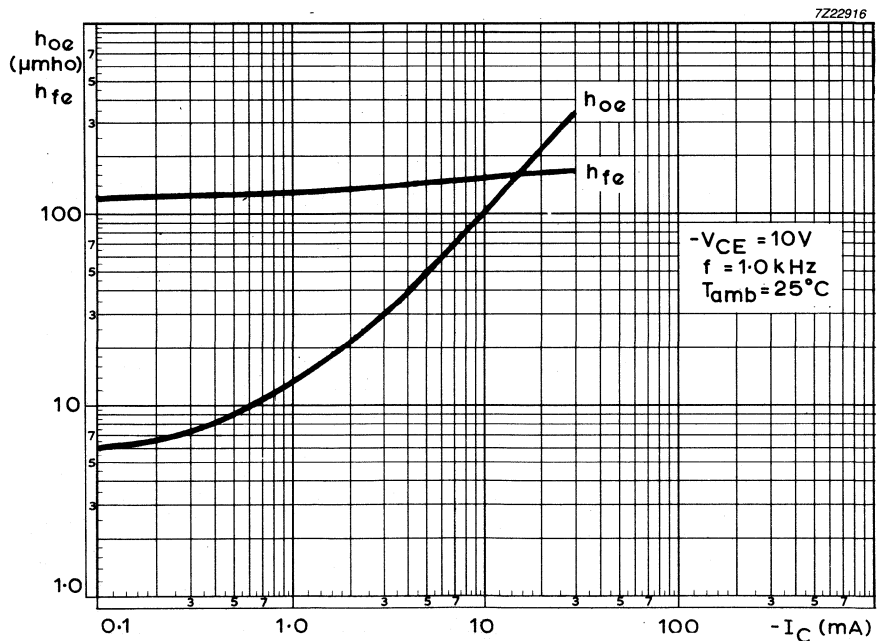

Fig.21 Typical forward current transfer ratio and typical output admittance plotted against collector current.



## SILICON PLANAR EPITAXIAL TRANSISTORS



N-P-N transistors in TO-39 metal envelopes intended for general purpose industrial applications.

### QUICK REFERENCE DATA

		BFY50	BFY51	BFY52	
Collector-base voltage (open emitter)	$V_{CBO}$	max. 80	60	40	V
Collector-emitter voltage (open base)	$V_{CEO}$	max. 35	30	20	V
Collector current (peak value)	$I_{CM}$	max. 1,0	1,0	1,0	A
Total power dissipation up to $T_{amb} = 25\text{ }^{\circ}\text{C}$	$P_{tot}$	max. 800	800	800	mW
Total power dissipation up to $T_{case} = 100\text{ }^{\circ}\text{C}$	$P_{tot}$	max. 2,86	2,86	2,86	W
D.C. current gain	$h_{FE}$	> 30	40	60	
$I_C = 150\text{ mA}; V_{CE} = 10\text{ V}$		typ. 112	123	142	
Transition frequency at $f = 35\text{ MHz}$	$f_T$	> 60	50	50	MHz
$I_C = 50\text{ mA}; V_{CE} = 10\text{ V}; T_{amb} = 25\text{ }^{\circ}\text{C}$					

### MECHANICAL DATA

Dimensions in mm

Fig. 1 TO-39.

Collector connected to case

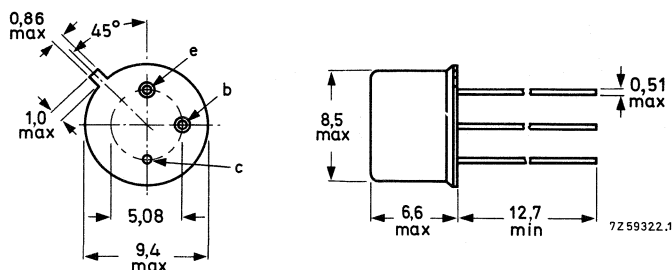

Maximum lead diameter is guaranteed only for 12,7 mm.

RATINGS

Limiting values of operation according to the absolute maximum system.

Electrical

	BFY50	BFY51	BFY52	
$V_{CBO}$ max.	80	60	40	V
$V_{CE}$ max. (cut-off, $I_C \leq 1\text{mA}$ )	80	60	40	V
$V_{CEO}$ max.	35	30	20	V
$V_{EBO}$ max.		6.0		V
$I_C$ max.		1.0		A
$I_{CM}$ max.		1.0		A
$-I_E$ max.		1.0		A
$-I_{EM}$ max.		1.0		A
$I_B$ max.		100		mA
$\pm I_{BM}$ max.		100		mA
$P_{tot}$ max. $T_{amb} \leq 25^\circ\text{C}$		800		mW
$T_{case} \leq 25^\circ\text{C}$		5.0		W
$T_{case} > 25, < 100^\circ\text{C}$		2.86		W

Temperature

$T_{stg}$	-65 to +150	$^\circ\text{C}$
$T_j$ max.	200	$^\circ\text{C}$

THERMAL CHARACTERISTICS

$R_{th(j-amb)}$ in free air	220	K/W
$R_{th(j-case)}$	35	K/W

## BFY50

ELECTRICAL CHARACTERISTICS ( $T_j = 25^\circ\text{C}$  unless otherwise stated)

		Min.	Typ.	Max.	
$I_{CBO}$	Collector cut-off current $V_{CB} = 80\text{V}, I_E = 0$	-	-	500	nA
	$V_{CB} = 80\text{V}, I_E = 0, T_j = 100^\circ\text{C}$	-	-	30	$\mu\text{A}$
	$V_{CB} = 60\text{V}, I_E = 0$	-	-	50	nA
	$V_{CB} = 60\text{V}, I_E = 0, T_j = 100^\circ\text{C}$	-	-	2.5	$\mu\text{A}$
$I_{EBO}$	Emitter cut-off current $V_{EB} = 6.0\text{V}, I_C = 0$	-	-	500	nA
	$V_{EB} = 5.0\text{V}, I_C = 0$	-	-	50	nA
	$V_{EB} = 5.0\text{V}, I_C = 0, T_j = 100^\circ\text{C}$	-	-	2.5	$\mu\text{A}$
$h_{FE}$	Static forward current transfer ratio $I_C = 10\text{mA}, V_{CE} = 10\text{V}$	20	-	-	
	$I_C = 150\text{mA}, V_{CE} = 10\text{V}$	30	-	-	
	$I_C = 500\text{mA}, V_{CE} = 10\text{V}$	20	-	-	
	$I_C = 1.0\text{A}, V_{CE} = 10\text{V}$	15	-	-	
$V_{CE(sat)}$	Collector-emitter saturation voltage $I_C = 10\text{mA}, I_B = 1.0\text{mA}$	-	-	0.20	V
	$I_C = 150\text{mA}, I_B = 15\text{mA}$	-	-	0.20	V
	$I_C = 500\text{mA}, I_B = 50\text{mA}$	-	-	0.70	V
	$I_C = 1.0\text{A}, I_B = 100\text{mA}$	-	-	1.00	V
$V_{BE(sat)}$	Base-emitter saturation voltage $I_C = 10\text{mA}, I_B = 1.0\text{mA}$	-	-	1.2	V
	$I_C = 150\text{mA}, I_B = 15\text{mA}$	-	-	1.3	V
	$I_C = 500\text{mA}, I_B = 50\text{mA}$	-	-	1.5	V
	$I_C = 1.0\text{A}, I_B = 100\text{mA}$	-	-	2.0	V
$C_{Tc}$	Collector capacitance $V_{CB} = 10\text{V}, I_E = I_e = 0,$ $f = 1.0\text{MHz}$	-	7.0	12	pF

BFY50

ELECTRICAL CHARACTERISTICS (contd.)

		Min.	Typ.	Max.	
$f_T$	Transition frequency $I_C = 50\text{mA}$ , $V_{CE} = 10\text{V}$ , $f = 35\text{MHz}$ , $T_{\text{amb}} = 25^\circ\text{C}$	60	140	-	MHz
Saturated switching times					
$I_C = 150\text{mA}$ , $I_{B(\text{on})} = -I_{B(\text{off})} = 15\text{mA}$ , $-V_{EE} = 10\text{V}$ , $-V_{BE(\text{off})} = 2.0\text{V}$					
$t_d$	Delay time	-	15	-	ns
$t_r$	Rise time	-	40	-	ns
$t_{\text{on}}$	Turn-on time	-	55	-	ns
$t_s$	Storage time	-	300	-	ns
$t_f$	Fall time	-	60	-	ns
$t_{\text{off}}$	Turn-off time	-	360	-	ns
h-parameters					
$h_{fe}$	$I_C = 1.0\text{mA}$ , $V_{CE} = 5.0\text{V}$ , $f = 1.0\text{kHz}$ , $T_{\text{amb}} = 25^\circ\text{C}$	-	65	-	
$h_{ie}$	$I_C = 10\text{mA}$ , $V_{CE} = 5.0\text{V}$ , $f = 1.0\text{kHz}$ , $T_{\text{amb}} = 25^\circ\text{C}$	-	750	-	$\Omega$
$h_{re}$		-	0.85	-	$\times 10^{-4}$
$h_{fe}$		-	80	-	
$h_{oe}$		-	35	-	$\mu\text{S}$

## BFY51

ELECTRICAL CHARACTERISTICS ( $T_j = 25^\circ\text{C}$  unless otherwise stated)

		Min.	Typ.	Max.	
$I_{CBO}$	Collector cut-off current				
	$V_{CB} = 60\text{V}, I_E = 0$	-	-	500	nA
	$V_{CB} = 60\text{V}, I_E = 0, T_j = 100^\circ\text{C}$	-	-	30	$\mu\text{A}$
	$V_{CB} = 40\text{V}, I_E = 0$	-	-	50	nA
$I_{EBO}$	Emitter cut-off current				
	$V_{EB} = 6.0\text{V}, I_C = 0$	-	-	500	nA
	$V_{EB} = 5.0\text{V}, I_C = 0, T_j = 100^\circ\text{C}$	-	-	2.5	$\mu\text{A}$
$h_{FE}$	Static forward current transfer ratio				
	$I_C = 10\text{mA}, V_{CE} = 10\text{V}$	30	-	-	
	$I_C = 150\text{mA}, V_{CE} = 10\text{V}$	40	-	-	
	$I_C = 500\text{mA}, V_{CE} = 10\text{V}$	25	-	-	
$V_{CE(sat)}$	Collector-emitter saturation voltage				
	$I_C = 10\text{mA}, I_B = 1.0\text{mA}$	-	-	0.20	V
	$I_C = 150\text{mA}, I_B = 15\text{mA}$	-	-	0.35	V
	$I_C = 500\text{mA}, I_B = 50\text{mA}$	-	-	1.00	V
$V_{BE(sat)}$	Base-emitter saturation voltage				
	$I_C = 10\text{mA}, I_B = 1.0\text{mA}$	-	-	1.2	V
	$I_C = 150\text{mA}, I_B = 15\text{mA}$	-	-	1.3	V
	$I_C = 500\text{mA}, I_B = 50\text{mA}$	-	-	1.5	V
$C_{Tc}$	Collector capacitance				
	$V_{CB} = 10\text{V}, I_E = I_e = 0, f = 1.0\text{MHz}$	-	7.0	12	pF

ELECTRICAL CHARACTERISTICS (contd.)

		Min.	Typ.	Max.	
$f_T$	Transition frequency $I_C = 50\text{mA}$ , $V_{CE} = 10\text{V}$ , $f = 35\text{MHz}$ , $T_{amb} = 25^\circ\text{C}$	50	-	-	MHz
Saturated switching times					
	$I_C = 150\text{mA}$ , $I_{B(on)} = -I_{B(off)} = 15\text{mA}$ , $-V_{EE} = 10\text{V}$ , $-V_{BE(off)} = 2.0\text{V}$				
$t_d$	Delay time	-	15	-	ns
$t_r$	Rise time	-	40	-	ns
$t_{on}$	Turn-on time	-	55	-	ns
$t_s$	Storage time	-	300	-	ns
$t_f$	Fall time	-	60	-	ns
$t_{off}$	Turn-off time	-	360	-	ns
h-parameters					
$h_{fe}$	$I_C = 1.0\text{mA}$ , $V_{CE} = 5.0\text{V}$ , $f = 1.0\text{kHz}$ , $T_{amb} = 25^\circ\text{C}$	-	65	-	
$h_{ie}$	$I_C = 10\text{mA}$ , $V_{CE} = 5.0\text{V}$ , $f = 1.0\text{kHz}$ , $T_{amb} = 25^\circ\text{C}$	-	750	-	$\Omega$
$h_{re}$		-	0.85	-	$\times 10^{-4}$
$h_{fe}$		-	80	-	
$h_{oe}$		-	35	-	$\mu\text{S}$



## BFY52

ELECTRICAL CHARACTERISTICS ( $T_j = 25^\circ\text{C}$  unless otherwise stated)

		Min.	Typ.	Max.	
$I_{CBO}$	Collector cut-off current				
	$V_{CB} = 40\text{V}, I_E = 0$	-	-	500	nA
	$V_{CB} = 40\text{V}, I_E = 0, T_j = 100^\circ\text{C}$	-	-	30	$\mu\text{A}$
	$V_{CB} = 30\text{V}, I_E = 0$	-	-	50	nA
$I_{EBO}$	Emitter cut-off current				
	$V_{EB} = 6.0\text{V}, I_C = 0$	-	-	500	nA
	$V_{EB} = 5.0\text{V}, I_C = 0, T_j = 100^\circ\text{C}$	-	-	2.5	$\mu\text{A}$
$h_{FE}$	Static forward current transfer ratio				
	$I_C = 10\text{mA}, V_{CE} = 10\text{V}$	30	-	-	
	$I_C = 150\text{mA}, V_{CE} = 10\text{V}$	60	-	-	
	$I_C = 500\text{mA}, V_{CE} = 10\text{V}$	30	-	-	
	$I_C = 1.0\text{A}, V_{CE} = 10\text{V}$	15	-	-	
$V_{CE(\text{sat})}$	Collector-emitter saturation voltage				
	$I_C = 10\text{mA}, I_B = 1.0\text{mA}$	-	-	0.20	V
	$I_C = 150\text{mA}, I_B = 15\text{mA}$	-	-	0.35	V
	$I_C = 500\text{mA}, I_B = 50\text{mA}$	-	-	1.00	V
	$I_C = 1.0\text{A}, I_B = 100\text{mA}$	-	-	1.60	V
$V_{BE(\text{sat})}$	Base-emitter saturation voltage				
	$I_C = 10\text{mA}, I_B = 1.0\text{mA}$	-	-	1.2	V
	$I_C = 150\text{mA}, I_B = 15\text{mA}$	-	-	1.3	V
	$I_C = 500\text{mA}, I_B = 50\text{mA}$	-	-	1.5	V
	$I_C = 1.0\text{A}, I_B = 100\text{mA}$	-	-	2.0	V
$C_{Tc}$	Collector capacitance				
	$V_{CB} = 10\text{V}, I_E = I_e = 0,$ $f = 1.0\text{MHz}$	-	7.0	12	pF

MEASUREMENT OF SATURATED SWITCHING TIMES

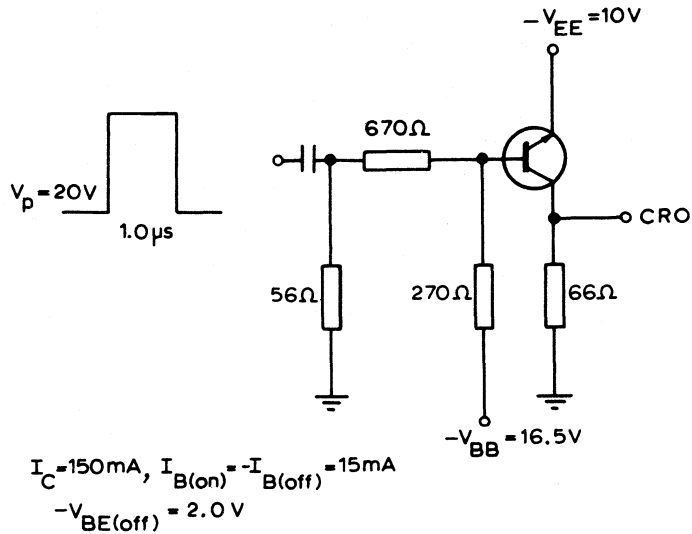

Fig. 2 Test circuit.

Switching waveforms

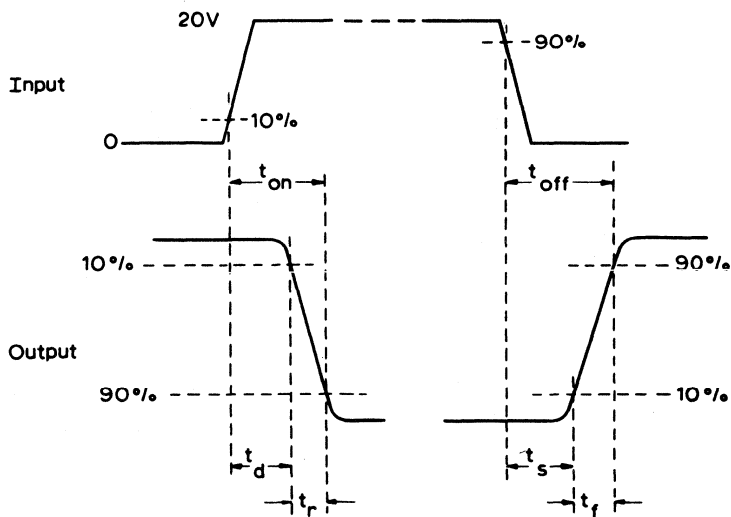

Fig. 3 Waveforms.

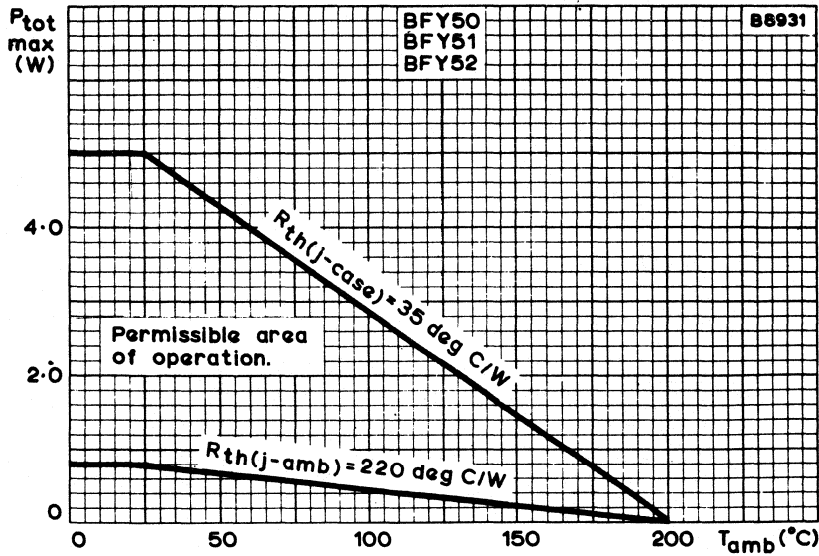

Fig. 4.

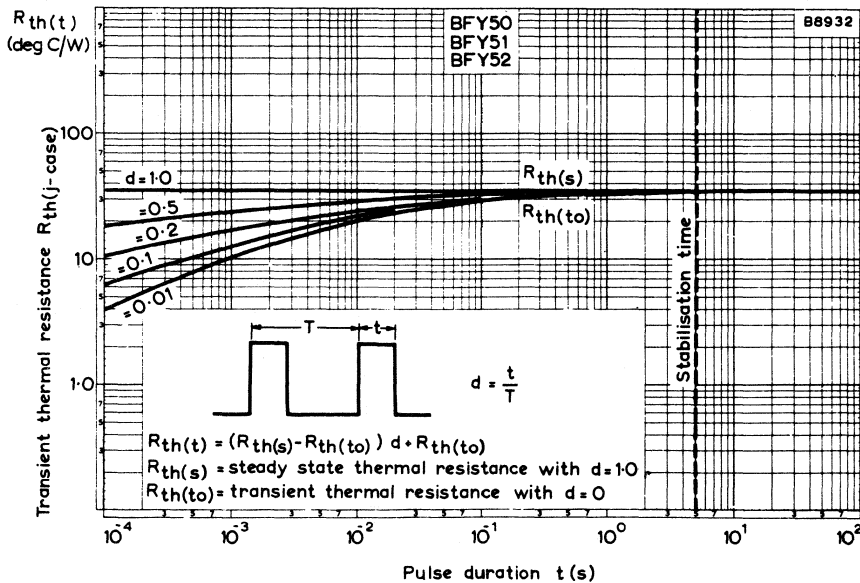

Fig. 5.

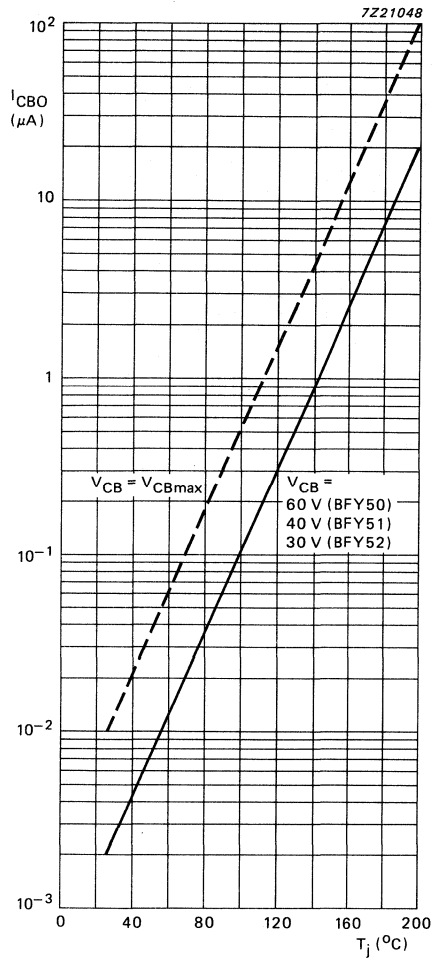

Fig. 6  $I_E = 0$ .

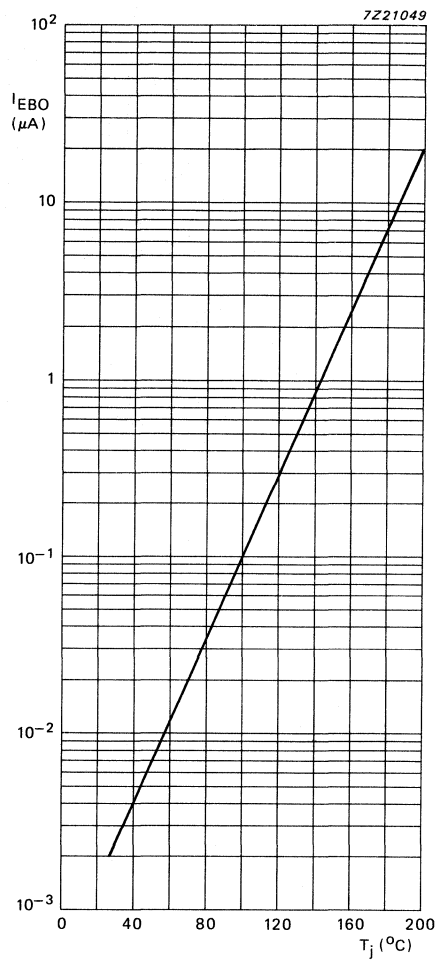

Fig. 7  $V_{EB} = 5,0 V$ ;  $I_C = 0$ ; typical values.

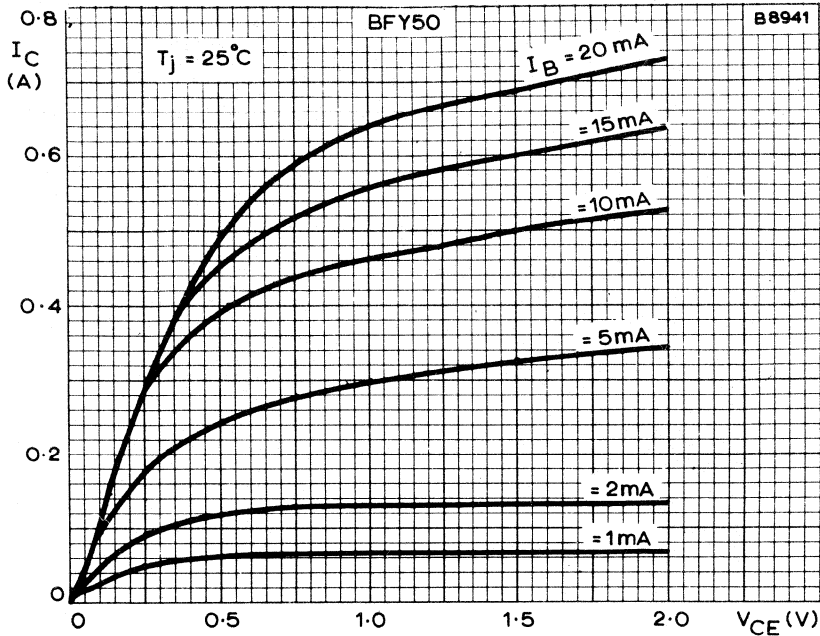

Fig. 8.

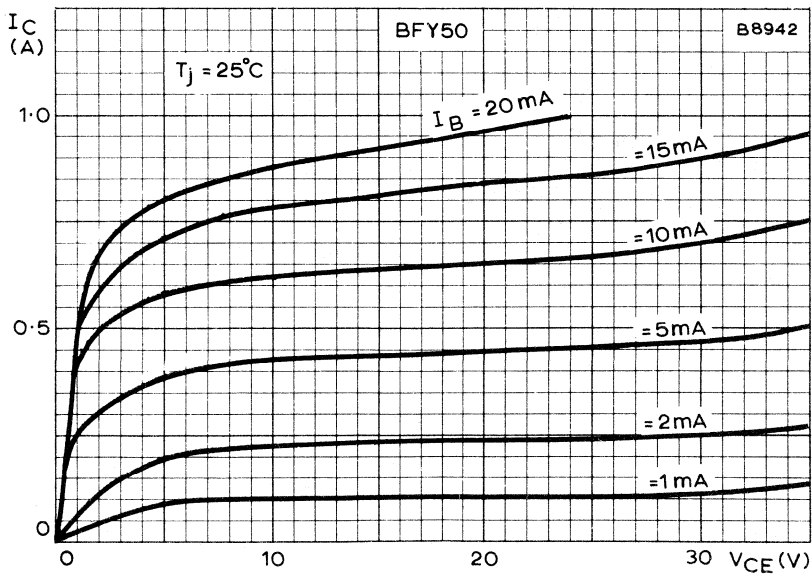

Fig. 9.

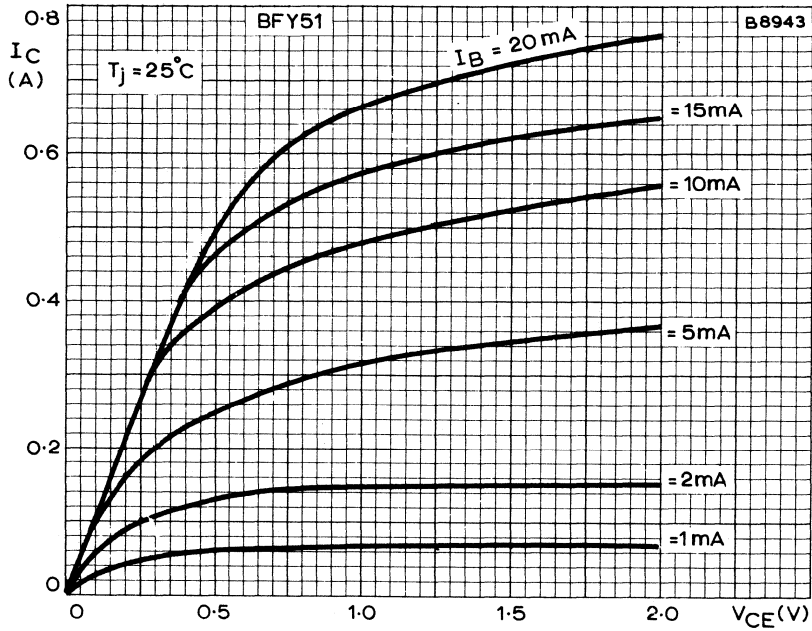

Fig. 10.

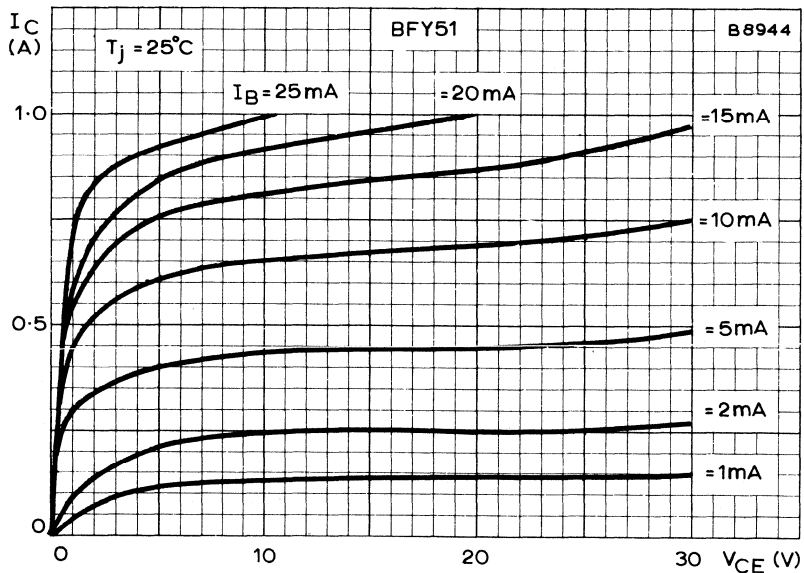

Fig. 11.

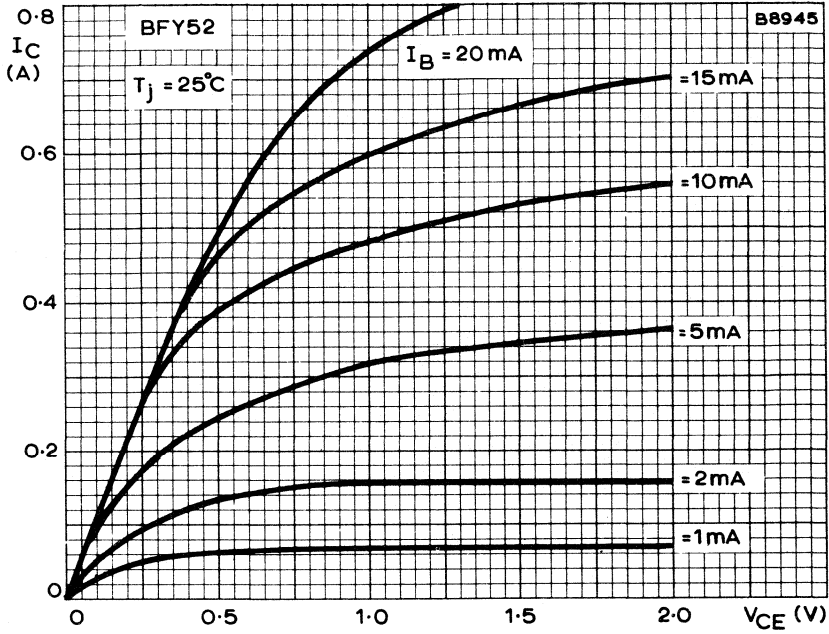

Fig. 12.

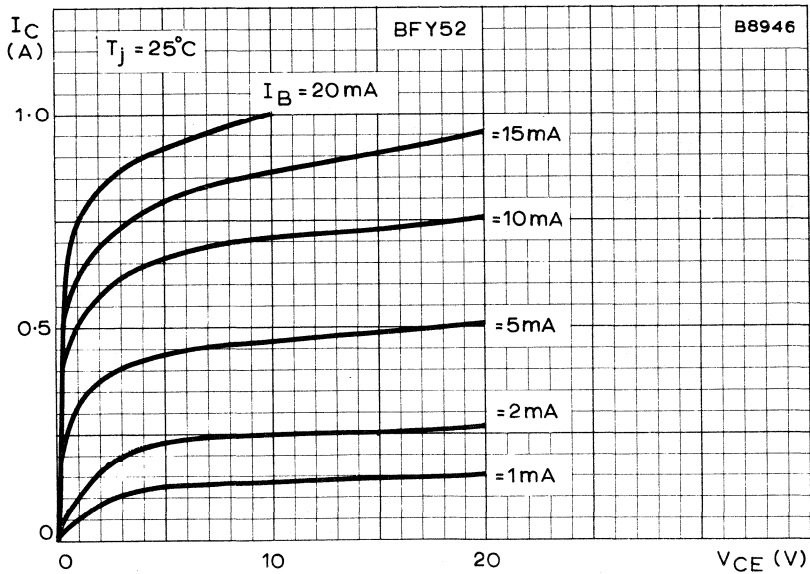

Fig. 13.

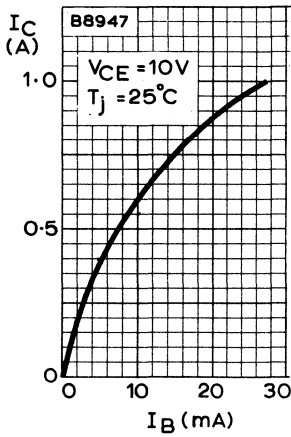

Fig. 14.

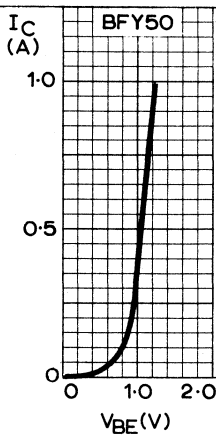

Fig. 15.

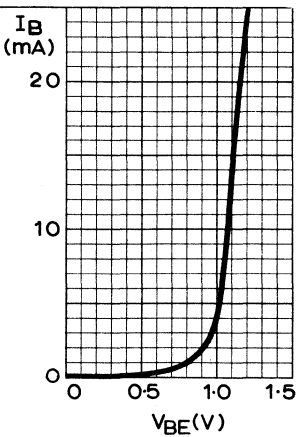

Fig. 16.

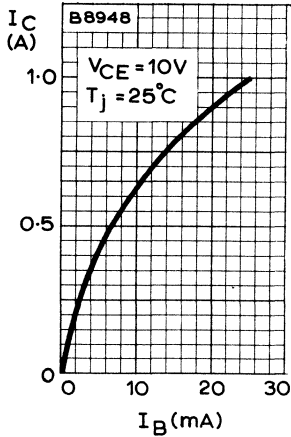

Fig. 17.

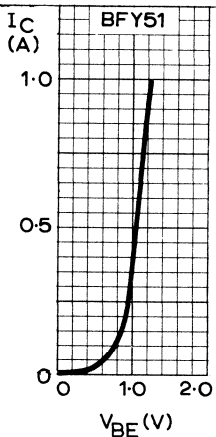

Fig. 18.

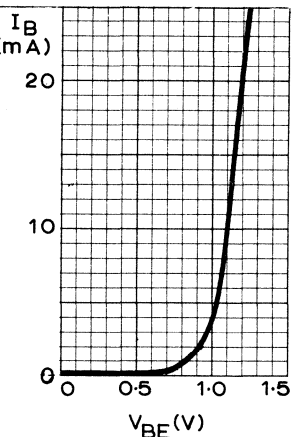

Fig. 19.

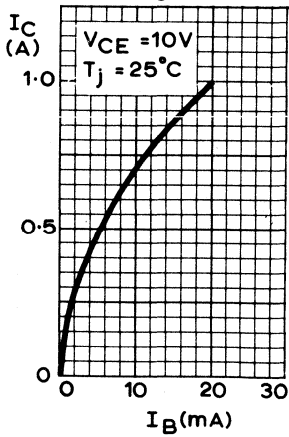

Fig. 20.

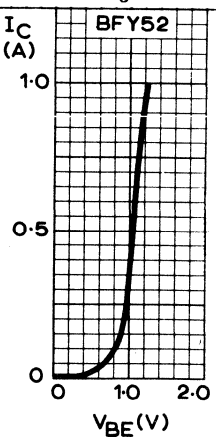

Fig. 21.

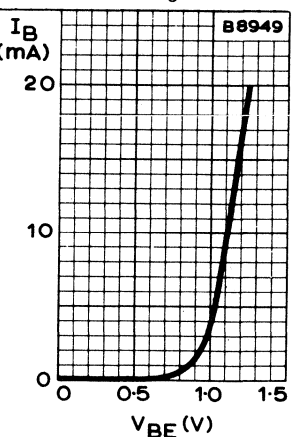

Fig. 22.



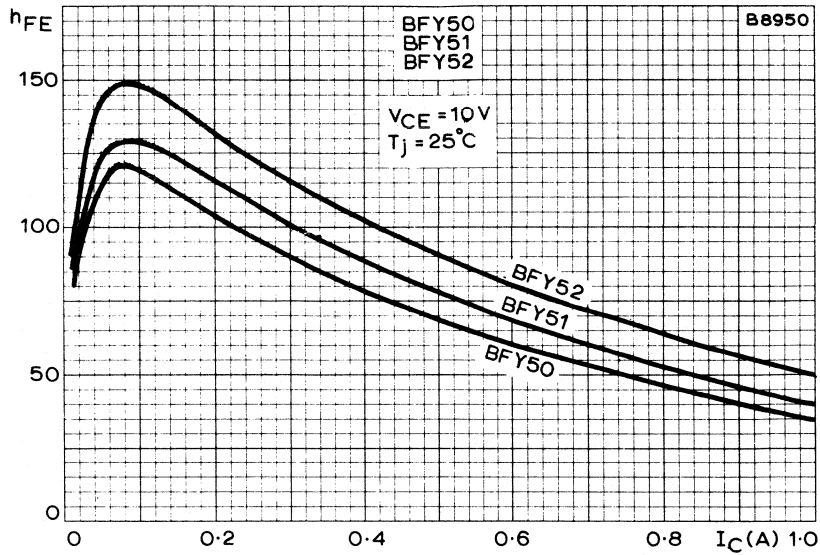

Fig. 23.

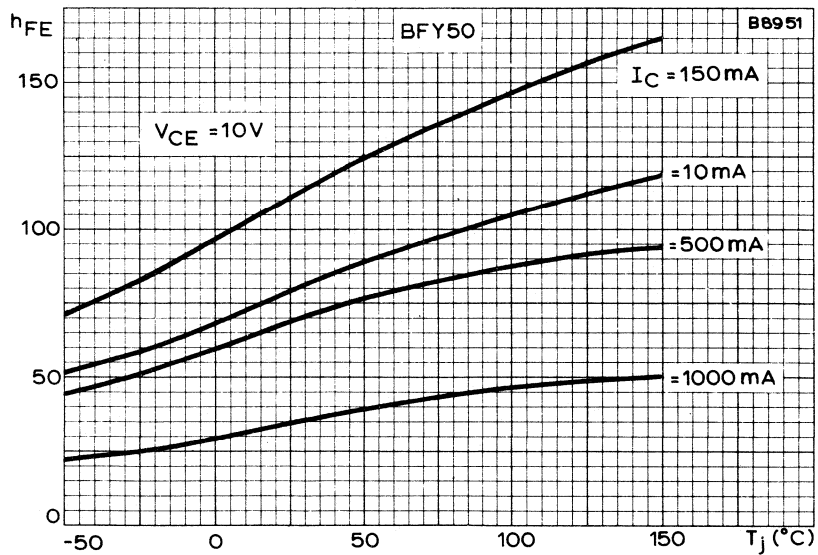

Fig. 24.

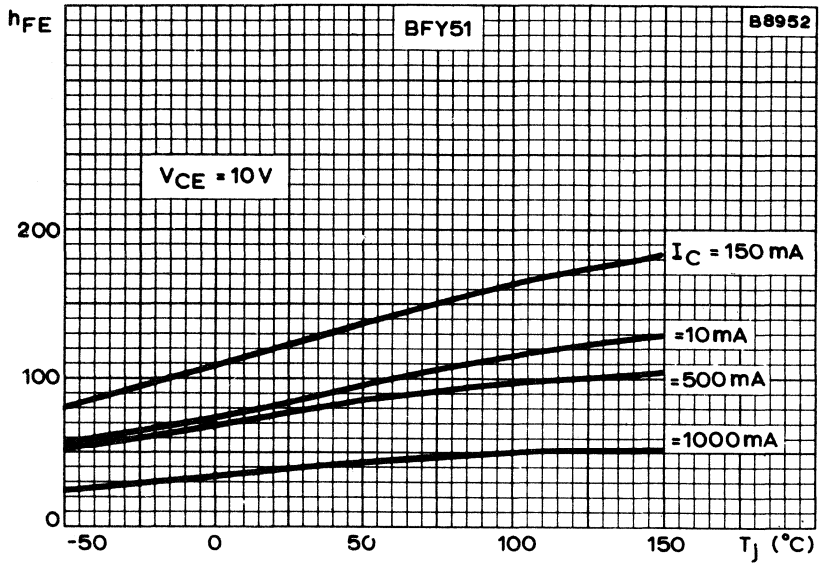

Fig. 25.

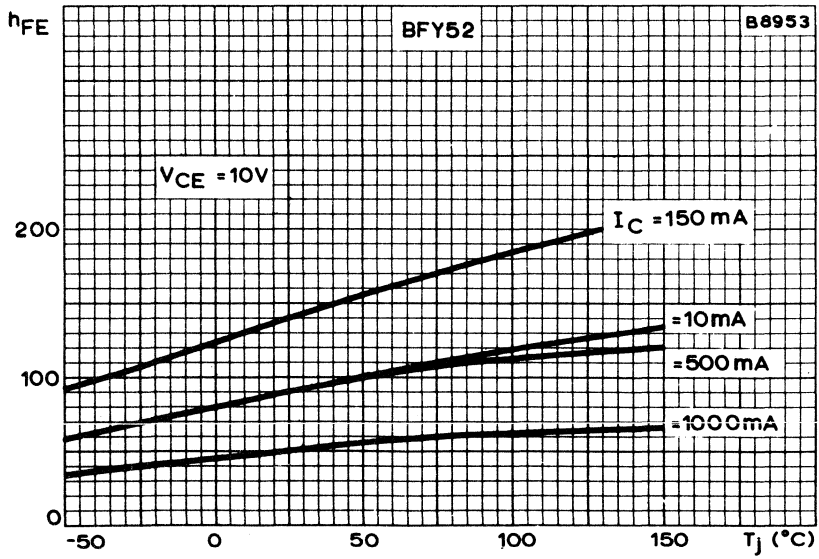

Fig. 26.

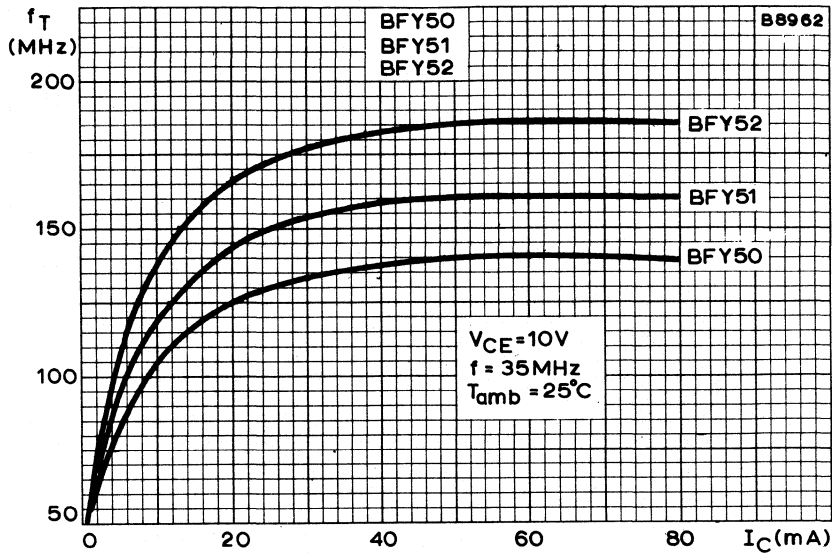

Fig. 27.

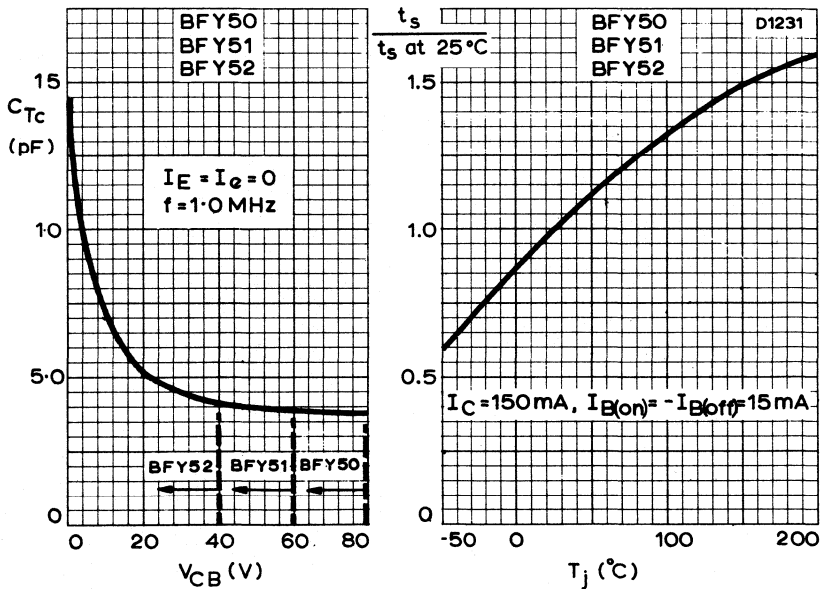

Fig. 28.

Fig. 29.

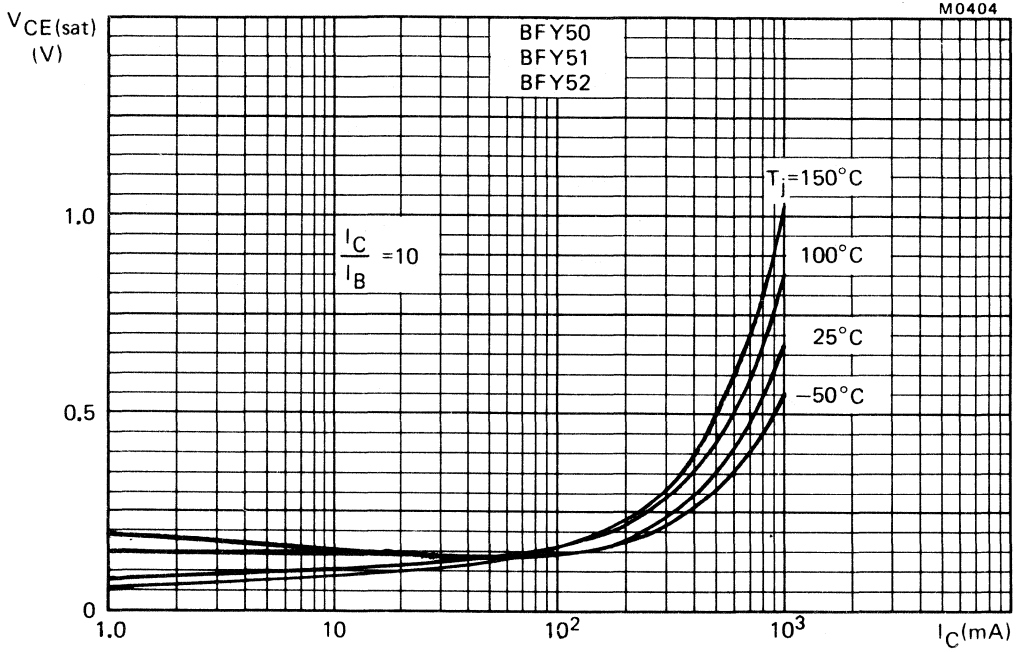

Fig. 30.

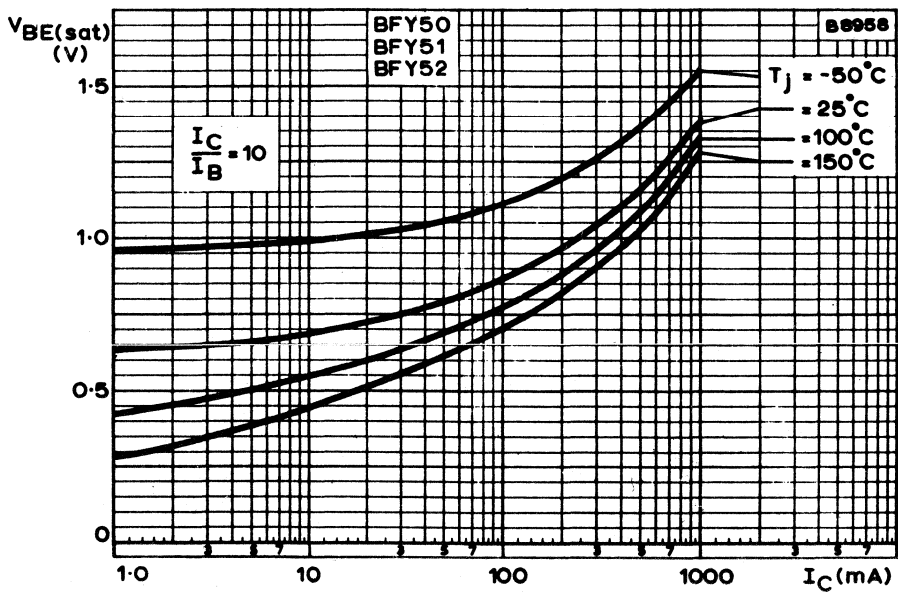

Fig. 31.

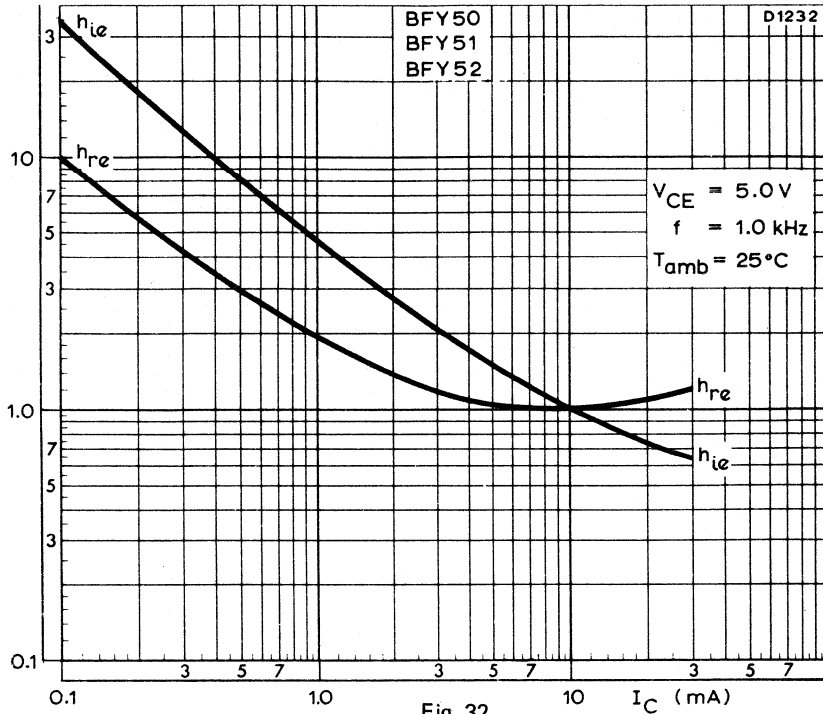

Fig. 32.

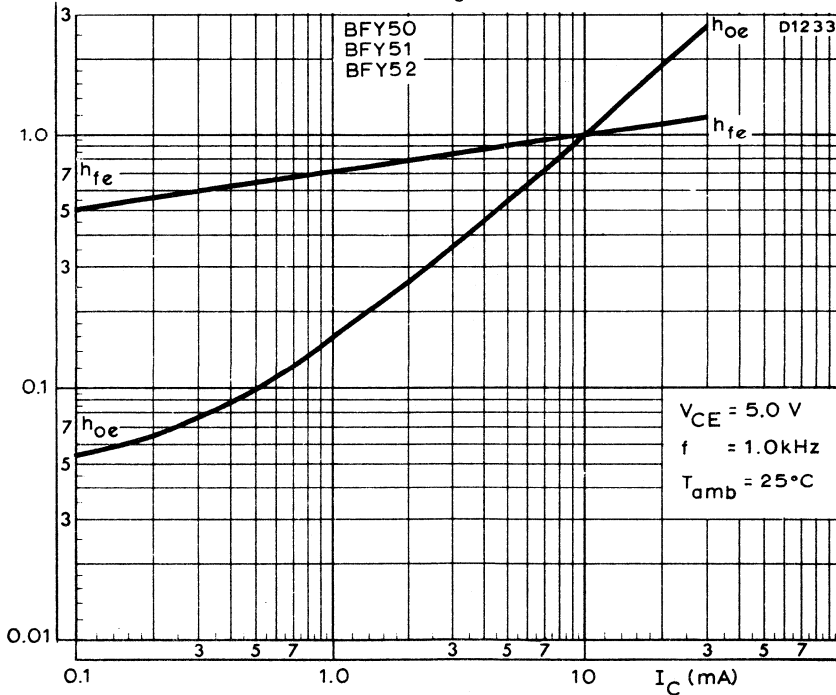

Fig. 33.



## SILICON PLANAR EPITAXIAL TRANSISTOR

N-P-N transistor in TO-39 metal case with the collector connected to the case. It is primarily intended for use in high frequency and very high frequency oscillators and amplifiers as well as for output stages of servo amplifiers.

### QUICK REFERENCE DATA

Collector-base voltage (open emitter)	$V_{CBO}$	max.	80 V
Collector-emitter voltage (open base)	$V_{CEO}$	max.	35 V
Collector current (d.c.)	$I_C$	max.	1 A
Total power dissipation up to $T_{amb} = 25\text{ }^\circ\text{C}$	$P_{tot}$	max.	800 mW
Junction temperature	$T_j$	max.	200 $^\circ\text{C}$
D.C. current gain at $T_j = 25\text{ }^\circ\text{C}$ $I_C = 150\text{ mA}; V_{CE} = 10\text{ V}$	$h_{FE}$		40 to 120
Transition frequency $I_C = 50\text{ mA}; V_{CE} = 10\text{ V}$	$f_T$	>	60 MHz
Collector-emitter saturation voltage $I_C = 1\text{ A}; I_B = 100\text{ mA}$	$V_{CEsat}$	<	1 V

### MECHANICAL DATA

Dimensions in mm

Fig. 1 TO-39.

Collector connected to case

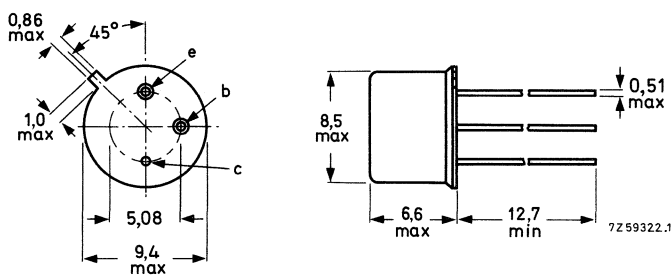

Maximum lead diameter is guaranteed only for 12,7 mm.

**RATINGS**

Limiting values in accordance with the Absolute Maximum System (IEC 134)

Collector-base voltage (open emitter)	$V_{CBO}$	max.	80 V
Collector-emitter voltage (open base)	$V_{CEO}$	max.	35 V
Emitter-base voltage (open collector)	$V_{EBO}$	max.	7 V
Collector current (d.c.)	$I_C$	max.	1 A
Collector current (peak value)	$I_{CM}$	max.	1 A
Emitter current (d.c.)	$-I_E$	max.	1 A
Emitter current (peak value)	$-I_{EM}$	max.	1 A
Total power dissipation up to $T_{amb} = 40\text{ °C}$	$P_{tot}$	max.	4 W
Total power dissipation without cooling fin up to $T_{amb} = 25\text{ °C}$	$P_{tot}$	max.	0,8 W
Storage temperature range	$T_{stg}$		-65 to +150 °C
Junction temperature	$T_j$	max.	200 °C

**THERMAL RESISTANCE**

From junction to ambient in free air	$R_{th\ j-a}$	=	0,22 K/mW
From junction to case	$R_{th\ j-c}$	=	0,035 K/mW



**CHARACTERISTICS**

$T_j = 25\text{ }^\circ\text{C}$  unless otherwise specified

Collector cut-off current

$I_E = 0; V_{CB} = 60\text{ V}$

$I_{CBO} < 10\text{ nA}$

$I_E = 0; V_{CB} = 60\text{ V}; T_j = 150\text{ }^\circ\text{C}$

$I_{CBO} < 10\text{ }\mu\text{A}$

Emitter cut-off current

$I_C = 0; V_{EB} = 5\text{ V}$

$I_{EBO} < 10\text{ nA}$

Saturation voltages

$I_C = 150\text{ mA}; I_B = 15\text{ mA}$

$V_{CEsat} < 0,2\text{ V}$

$I_C = 1\text{ A}; I_B = 100\text{ mA} \text{ *) **}$

$V_{CEsat} < 1,0\text{ V}$

$V_{BEsat} < 1,6\text{ V}$

Sustaining voltage

$I_C = 30\text{ mA}; I_B = 0 \text{ **}$

$V_{CEOsust} > 35\text{ V}$

D.C. current gain \*\*

$I_C = 10\text{ mA}; V_{CE} = 10\text{ V}$

$h_{FE} > 30$

$I_C = 150\text{ mA}; V_{CE} = 10\text{ V}$

$h_{FE} \quad 40\text{ to }120$

$I_C = 1\text{ A}; V_{CE} = 10\text{ V}$

$h_{FE} > 15$

Feedback time constant

$I_C = 10\text{ mA}; V_{CB} = 10\text{ V}; f = 4\text{ MHz}$

$r_b, C_c < 800\text{ ps}$

Collector capacitance at  $f = 500\text{ kHz}$

$I_E = I_e = 0; V_{CB} = 10\text{ V}$

$C_c < 12\text{ pF}$

Emitter capacitance at  $f = 500\text{ kHz}$

$I_C = I_c = 0; V_{EB} = 0,5\text{ V}$

$C_e < 80\text{ pF}$

Transition frequency

$I_C = 50\text{ mA}; V_{CE} = 10\text{ V}$

$f_T > 60\text{ MHz}$

\* Measured with a lead length of 1 cm.

\*\* Measured under pulsed conditions to avoid excessive dissipation.  
Pulse duration = 300  $\mu\text{s}$ ; duty cycle  $\delta < 0,01$ .

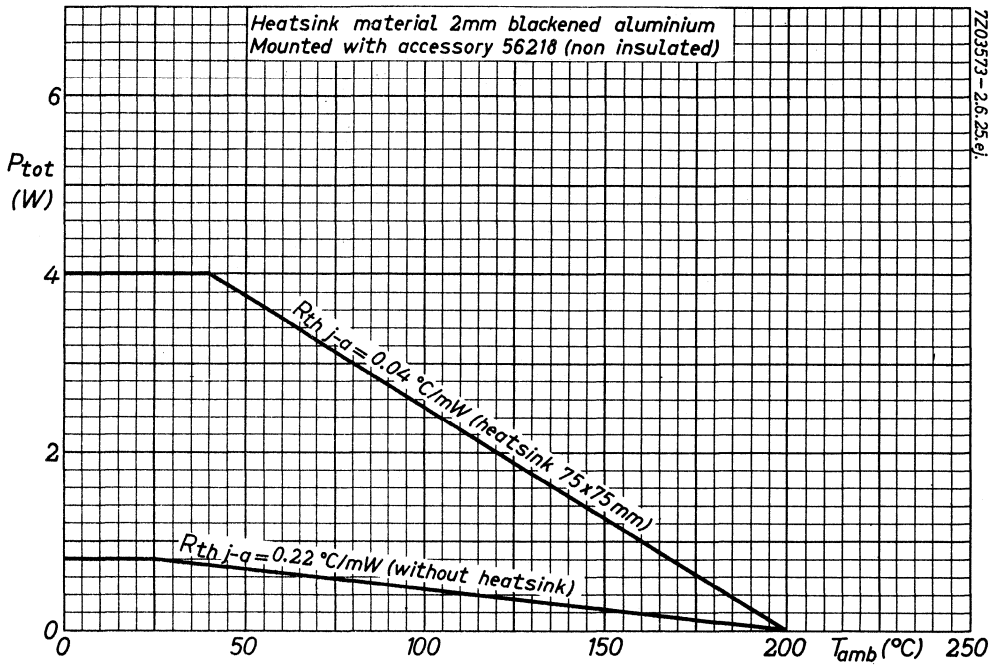

Fig. 2.

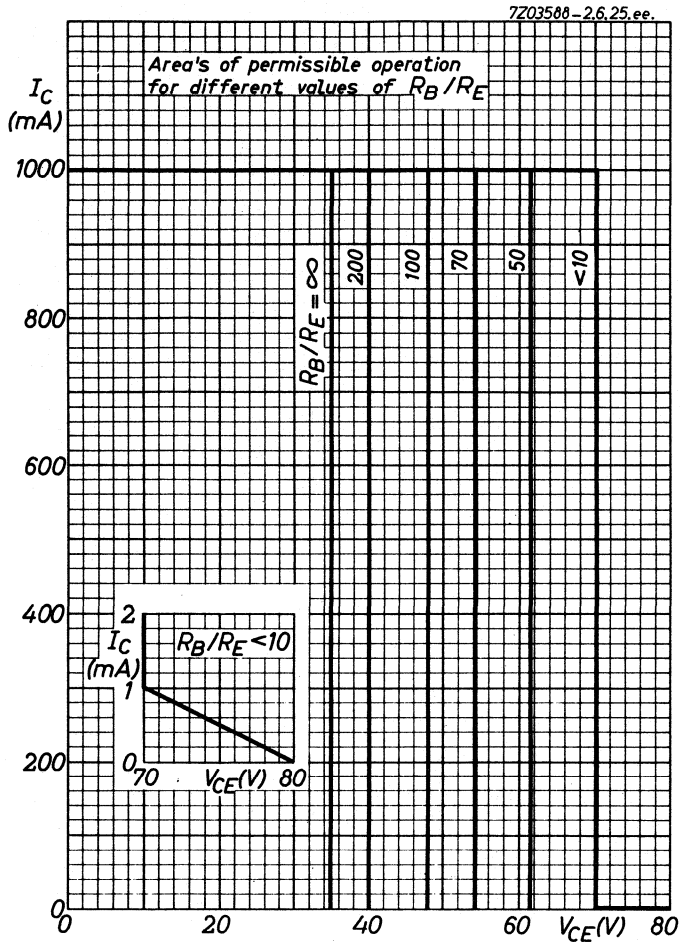

Fig. 3.

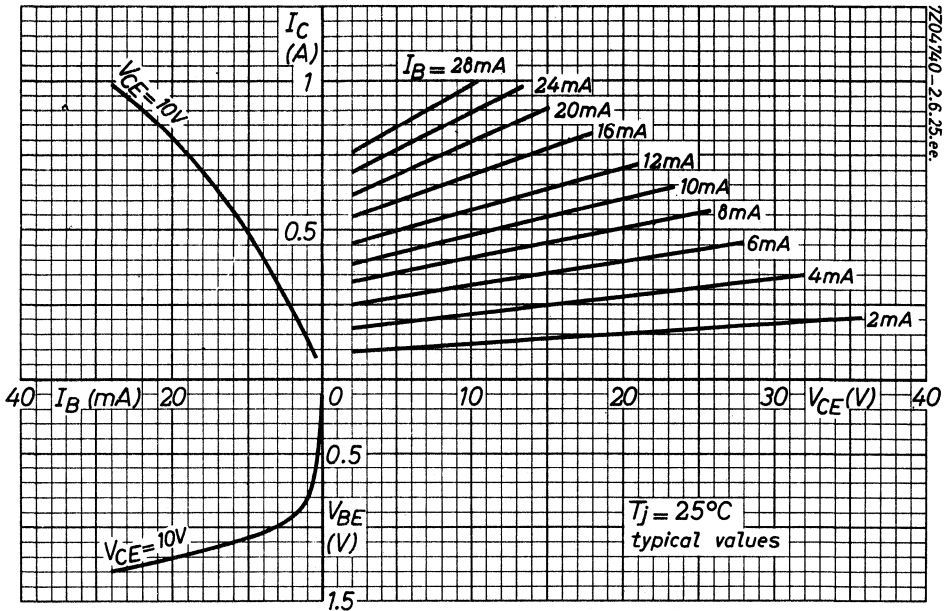

Fig. 4.

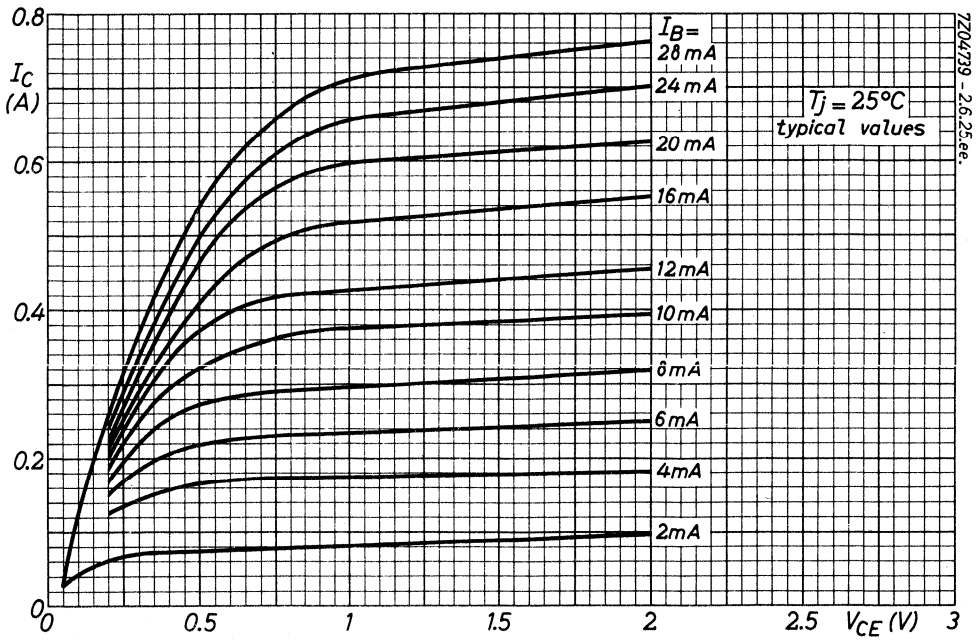

Fig. 5.

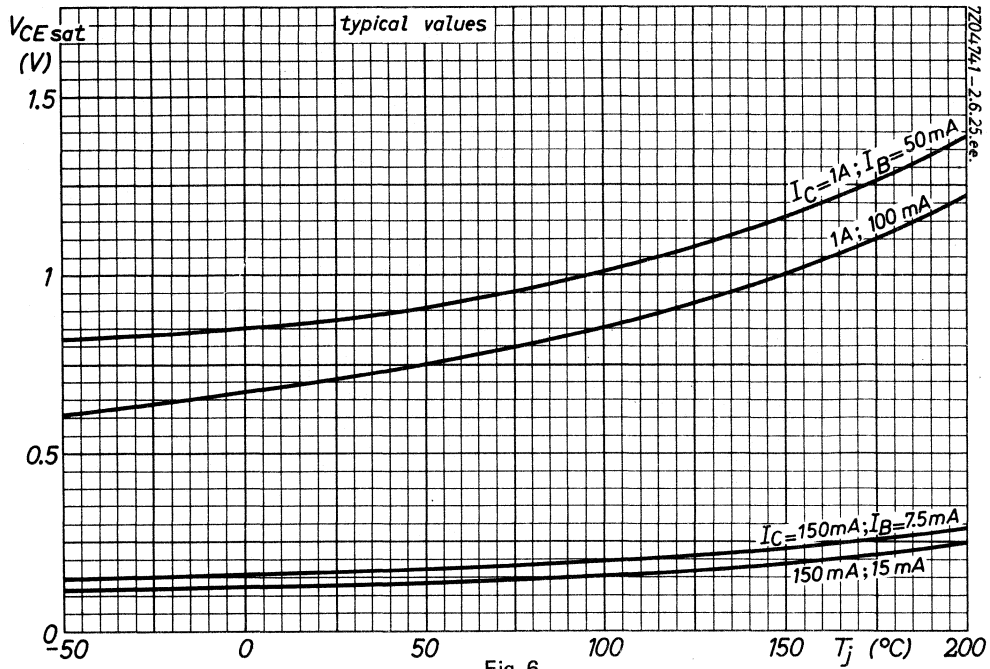

Fig. 6.

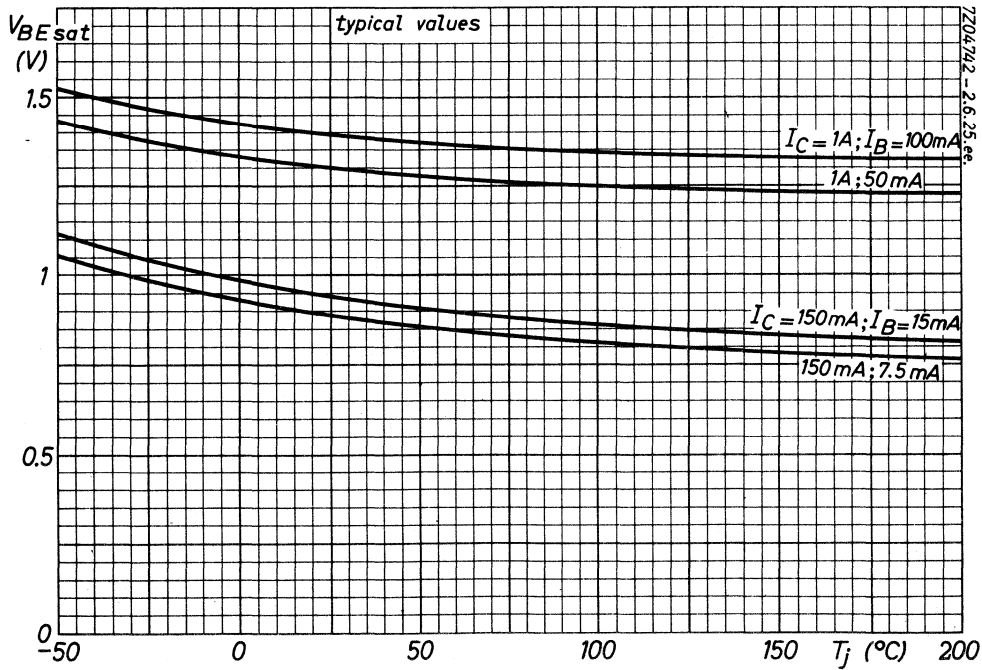

Fig. 7.

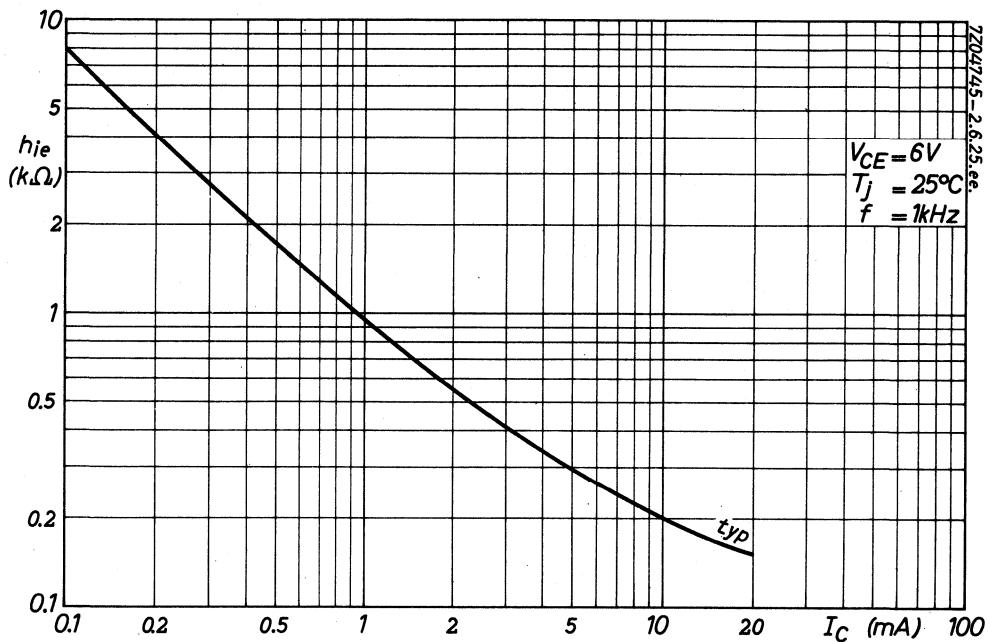

Fig. 8.

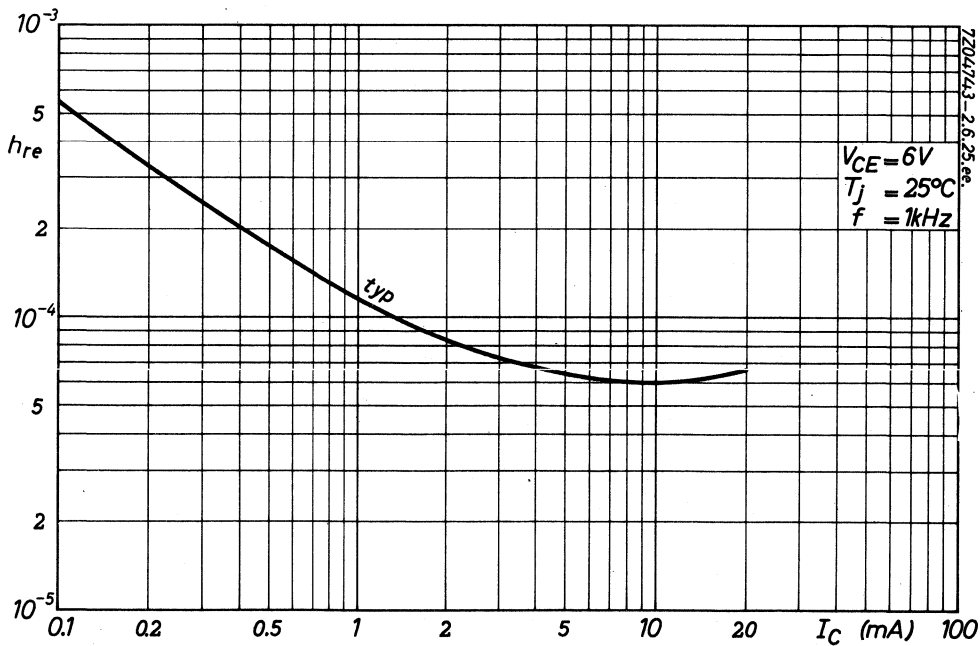

Fig. 9.

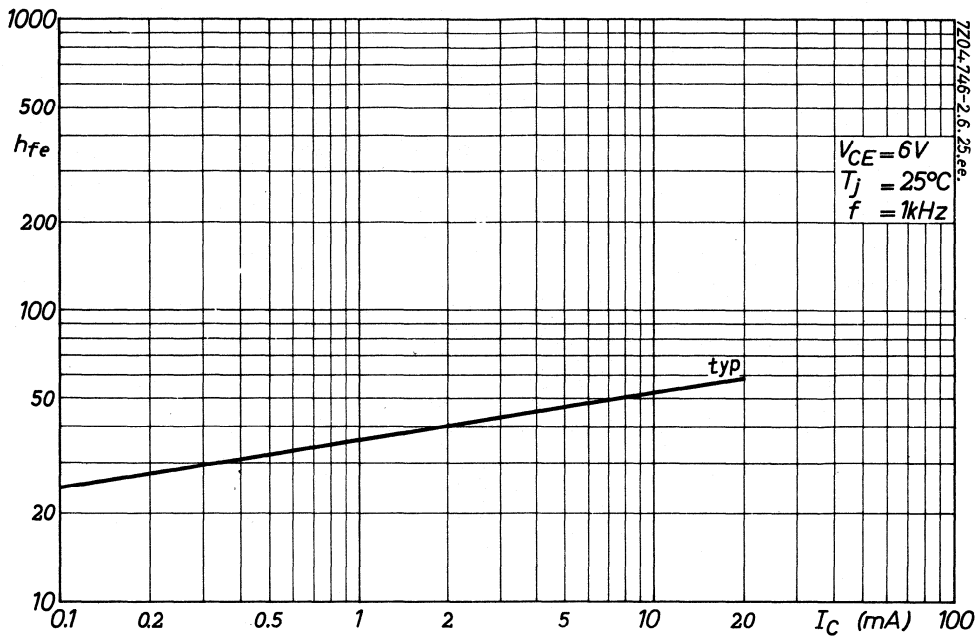

Fig. 10.

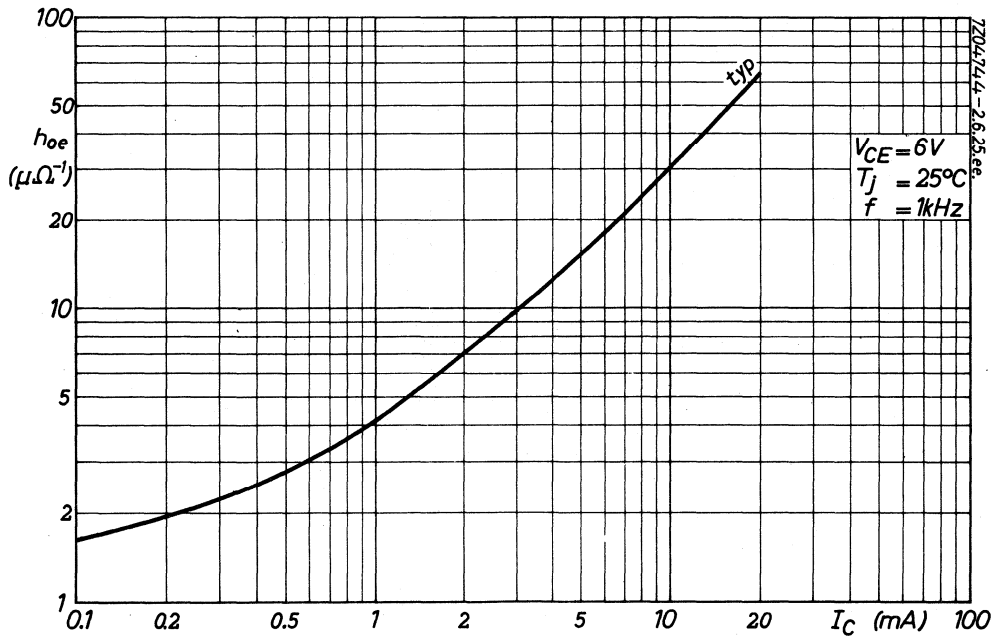

Fig. 11.

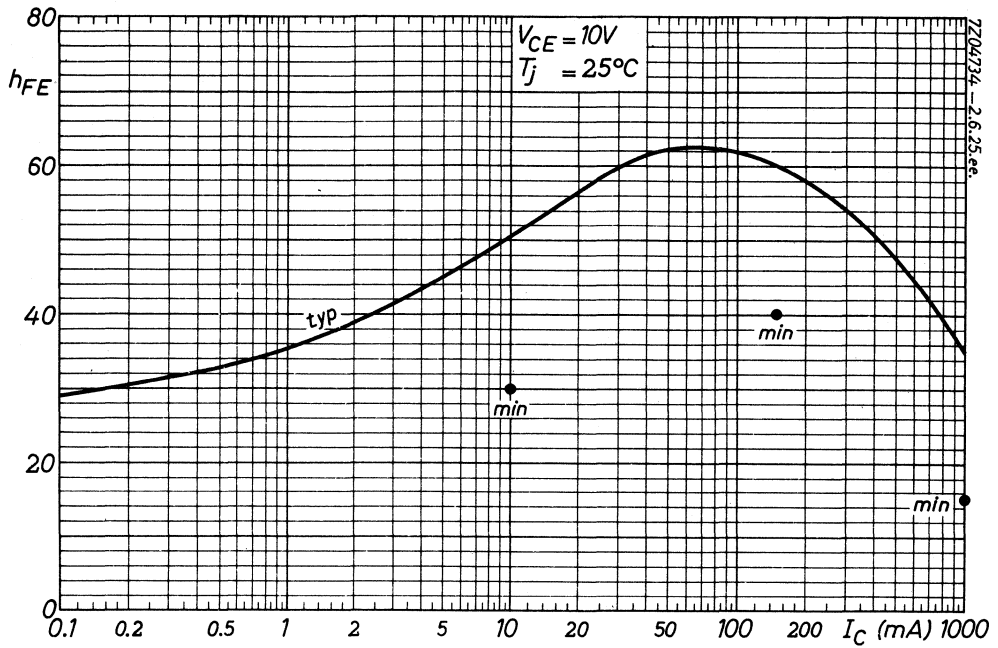

Fig. 12.

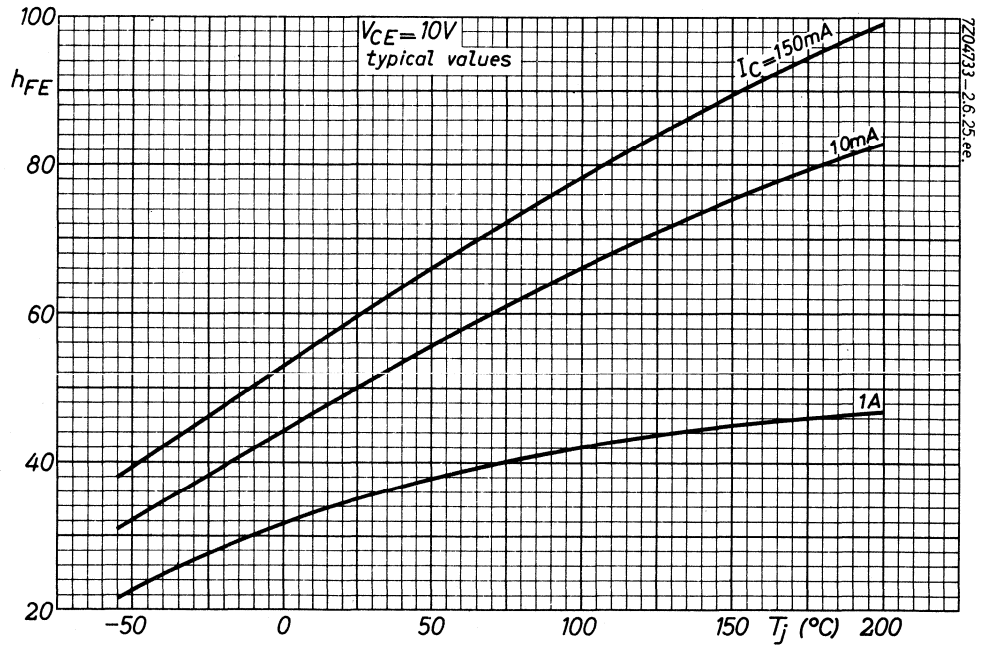

Fig. 13.



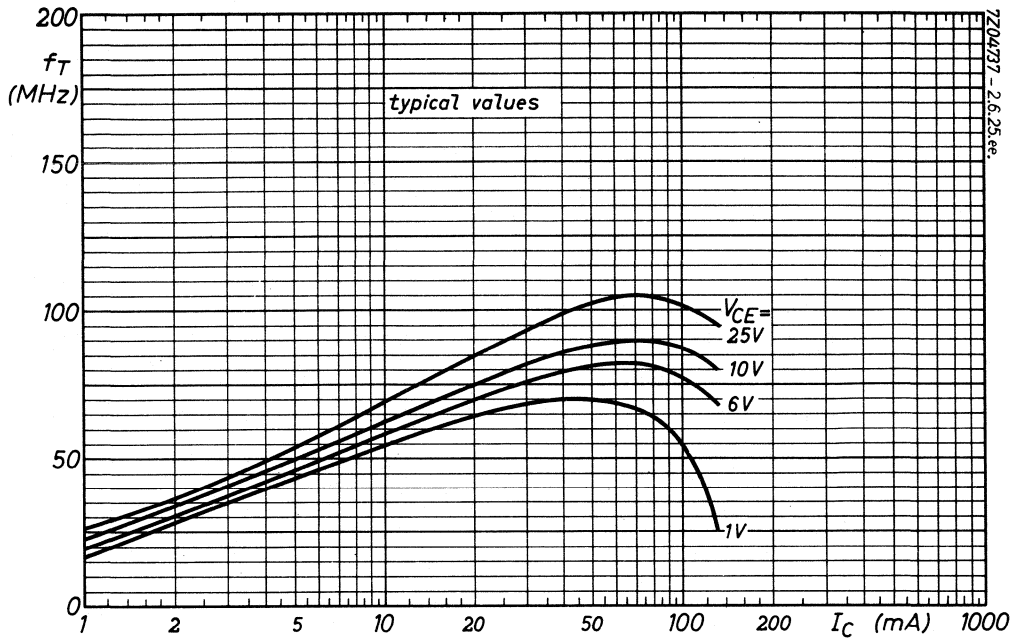

Fig. 14.

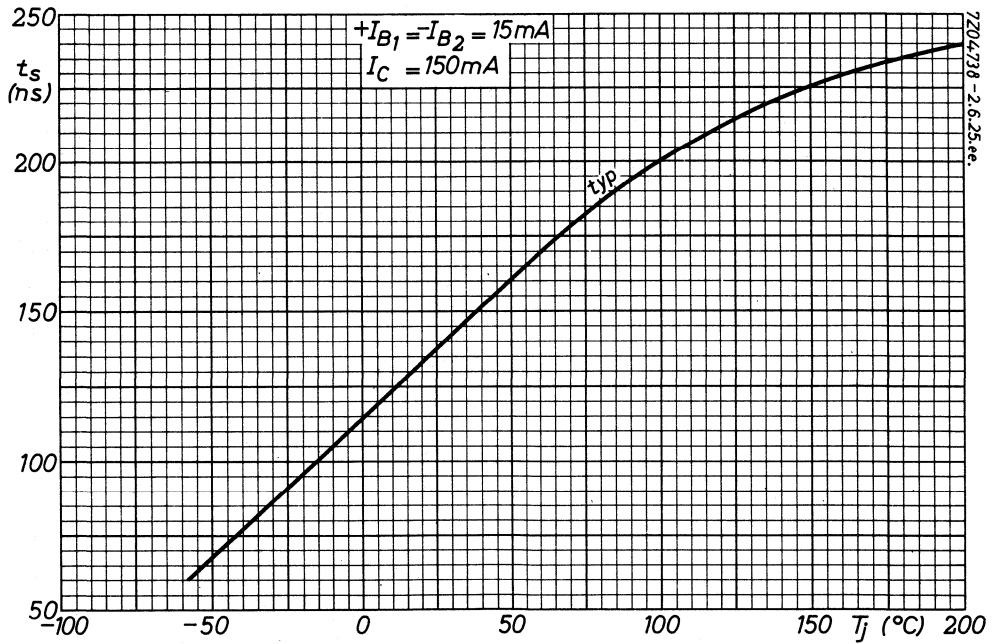

Fig. 15.

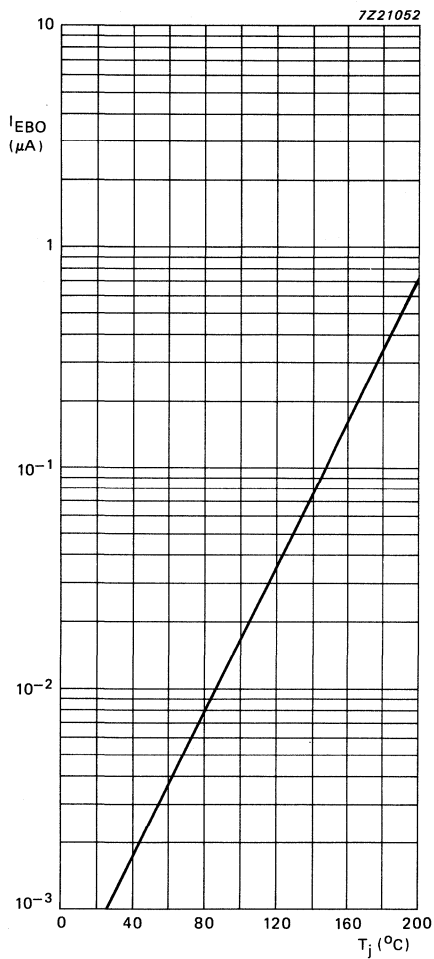

Fig. 16  $V_{EB} = 5$  V; typical values.

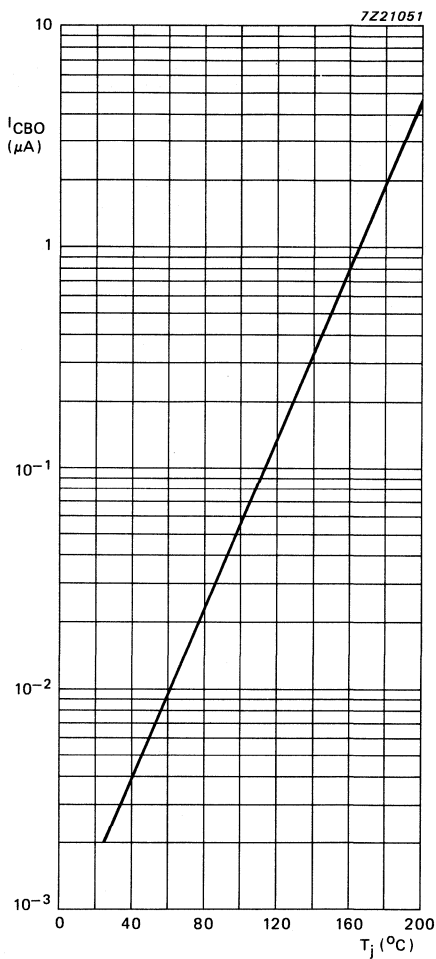

Fig. 17  $V_{CB} = 60$  V; typical values.

## SILICON CONTROLLED SWITCH

The BR101 is a planar p-n-p-n switch in a TO-72 metal envelope, intended for time base circuits and other television applications. It is also suitable as trigger device for thyristors. It is an integrated p-n-p/n-p-n transistor pair of which all electrodes are accessible. The collector of the n-p-n transistor is connected to the case.

### QUICK REFERENCE DATA

#### p-n-p transistor

Emitter-base voltage (open collector)  $-V_{EBO}$  max. 50 V

#### n-p-n transistor

Collector-base voltage (open emitter)  $V_{CBO}$  max. 50 V

Repetitive peak emitter current (peak value)  $-I_{ERM}$  max. 2,5 A

Total power dissipation up to  $T_{amb} = 25\text{ }^{\circ}\text{C}$   $P_{tot}$  max. 275 mW

Junction temperature  $T_j$  max. 150  $^{\circ}\text{C}$

#### Forward on-state voltage

$I_A = 50\text{ mA}$ ;  $I_{AG} = 0$ ;  $R_{KG-K} = 10\text{ k}\Omega$   $V_{AK} < 1,4\text{ V}$

#### Holding current

$I_{AG} = 10\text{ mA}$ ;  $-V_{BB} = 2\text{ V}$ ;  $R_{KG-K} = 10\text{ k}\Omega$   $I_H < 1,0\text{ mA}$

### MECHANICAL DATA

Dimensions in mm

Fig. 1 TO-72.

Collector of the n-p-n transistor (ag = anode gate) connected to the case

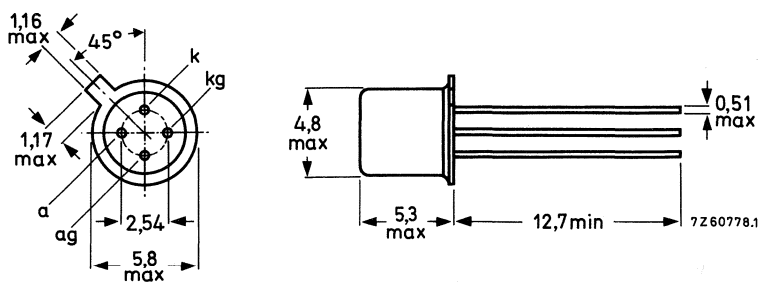

**RATINGS**

Limiting values in accordance with the Absolute Maximum System (IEC 134)

			p-n-p	n-p-n
Collector-base voltage (open emitter)	V <sub>CBO</sub>	max.	-50	50 V
Collector-emitter voltage (R <sub>BE</sub> = 10 kΩ)	V <sub>CER</sub>	max.	-	50 V
Collector-emitter voltage (open base)	V <sub>CEO</sub>	max.	-50	- V
Emitter-base voltage (open collector)	V <sub>EBO</sub>	max.	-50	5 V *
Emitter current (d.c.)	I <sub>E</sub>	max.	175	-175 mA
Repetitive peak emitter current (peak value) t <sub>p</sub> = 10 μs; δ = 0,01	I <sub>ERM</sub>	max.	2,5	-2,5 A
Collector current (d.c.)	I <sub>C</sub>	max.	-	175 mA **
Collector current (peak value)	I <sub>CM</sub>	max.	-	175 mA
Total power dissipation up to T <sub>amb</sub> = 25 °C	P <sub>tot</sub>	max.	275	mW
Storage temperature range	T <sub>stg</sub>		-65 to +150	°C
Operating junction temperature	T <sub>j</sub>	max.	150	°C

**THERMAL RESISTANCE**

From junction to ambient	R <sub>th j-a</sub>	=	0,45	K/mW
--------------------------	---------------------	---	------	------

\* Exceeding of this voltage is allowed during the discharge of a capacitor of max. 390 pF, provided the charge does not exceed 50 nC.

\*\* Provided the I<sub>E</sub> rating will not be exceeded.

**MEANING OF SYMBOLS**, used in the schematic presentation of the S.C.S.

**2 transistors equivalent circuit**

n-p-n transistor + p-n-p transistor

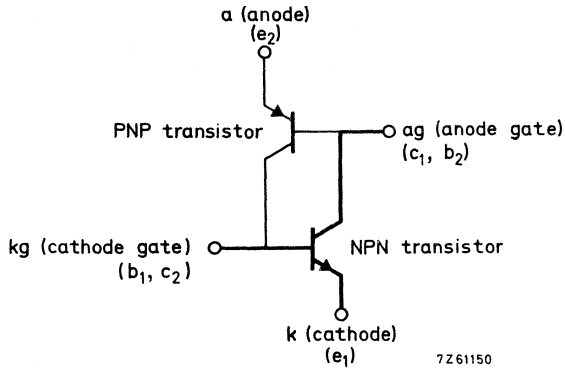

**p-n-p-n S.C.S. equivalent circuit**

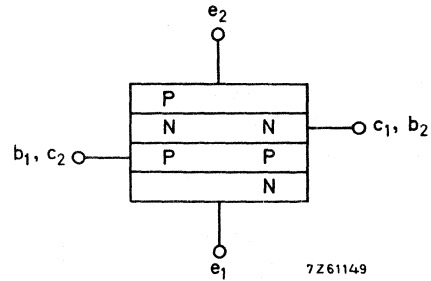

**S.C.S. symbol**

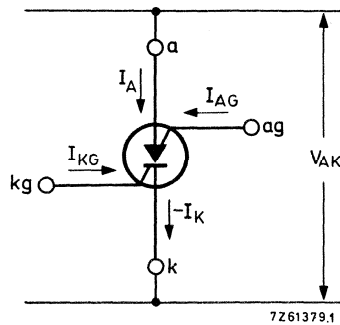

**CHARACTERISTICS**

$T_j = 25\text{ }^\circ\text{C}$  unless otherwise specified

**Individual N-P-N transistor**

Collector cut-off current

$V_{CE} = 50\text{ V}; R_{BE} = 10\text{ k}\Omega$

$I_{CER} < 0,5\text{ }\mu\text{A}$

$V_{CE} = 50\text{ V}; R_{BE} = 10\text{ k}\Omega; T_j = 150\text{ }^\circ\text{C}$

$I_{CER} < 50\text{ }\mu\text{A}$

Emitter cut-off current

$I_C = 0; V_{EB} = 5\text{ V}; T_j = 150\text{ }^\circ\text{C}$

$I_{EBO} < 50\text{ }\mu\text{A}$

## CHARACTERISTICS (continued)

## Individual N-P-N transistor

Saturation voltages

$I_C = 10 \text{ mA}; I_B = 1 \text{ mA}$

$V_{CEsat}$	<	500 mV
$V_{BEsat}$	<	900 mV

D.C. current gain

$I_C = 10 \text{ mA}; V_{CE} = 2 \text{ V}$

$h_{FE}$	>	50
----------	---	----

Transition frequency

$I_C = 10 \text{ mA}; V_{CE} = 2 \text{ V}$

$f_T$	typ.	300 MHz
-------	------	---------

Collector capacitance

$I_E = I_e = 0; V_{CB} = 20 \text{ V}$

$C_c$	<	5 pF
-------	---	------

Emitter capacitance

$I_C = I_c = 0; V_{EB} = 1 \text{ V}$

$C_e$	<	25 pF
-------	---	-------

## Individual P-N-P transistor

Collector cut-off current

$I_B = 0; -V_{CE} = 50 \text{ V}; T_j = 150 \text{ }^\circ\text{C}$

$-I_{CEO}$	<	50 $\mu\text{A}$
------------	---	------------------

Emitter cut-off current

$I_C = 0; -V_{EB} = 50 \text{ V}; T_j = 150 \text{ }^\circ\text{C}$

$-I_{EBO}$	<	50 $\mu\text{A}$
------------	---	------------------

D.C. current gain

$I_E = 1 \text{ mA}; V_{CB} = 0$

$h_{FE}$		0,25 to 2,5
----------	--	-------------

## Combined device

Forward on-state voltage at  $R_{KG-K} = 10 \text{ k}\Omega$ 

$I_A = 50 \text{ mA}; I_{AG} = 0$

$V_{AK}$	<	1,4 V
----------	---	-------

$I_A = 1 \text{ mA}; I_{AG} = 10 \text{ mA}$

$V_{AK}$	<	1,2 V
----------	---	-------

Holding current at  $R_{KG-K} = 10 \text{ k}\Omega$ 

$I_{AG} = 10 \text{ mA}; -V_{BB} = 2 \text{ V}$

$I_H$	<	1,0 mA
-------	---	--------

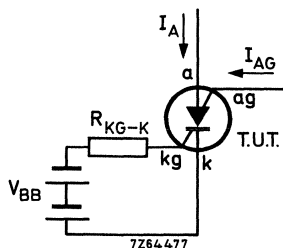

Data sheet	
status	Preliminary specification
date of issue	December 1990

# BRY39

## Programmable unijunction transistor

### DESCRIPTION

A planar pnpn trigger device in a TO-72 metal envelope, intended for use in switching applications such as motor control, oscillators, relay replacement, timers, pulse shapers, etc.

### PINNING

Anode gate (ag) connected to case.

PIN	DESCRIPTION
1	cathode
2	cathode gate
3	anode gate
4	anode

### ACCESSORIES

56246 (distance disc).

### QUICK REFERENCE DATA

SYMBOL	PARAMETER	CONDITIONS	MIN.	MAX.	UNIT
$V_{GA}$	gate-anode voltage		-	70	V
$I_A$	anode current	DC value up to $T_{amb} = 25\text{ }^\circ\text{C}$	-	175	mA
$T_j$	operating junction temperature		-	150	$^\circ\text{C}$
$I_{(P)}$	peak point current	$V_S = 10\text{ V}$ $R_G = 10\text{ k}\Omega$	-	0.2	$\mu\text{A}$

### PIN CONFIGURATION

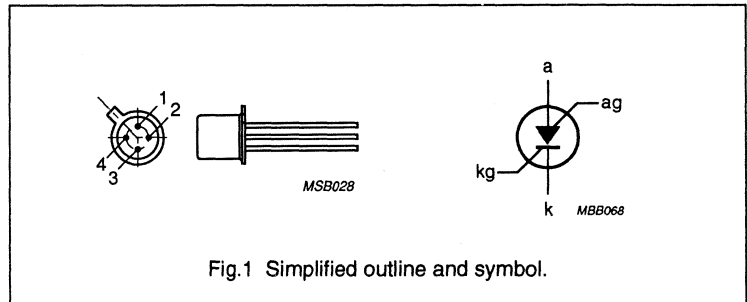

Fig.1 Simplified outline and symbol.

# Programmable unijunction transistor

## BRY39

### LIMITING VALUES

In accordance with the Absolute Maximum System (IEC 134).

SYMBOL	PARAMETER	CONDITIONS	MIN.	MAX.	UNIT
$V_{GA}$	gate-anode voltage		–	70	V
$I_A$	anode current	average value up to $T_{amb} = 25\text{ °C}$	–	175	mA
$I_{ARM}$	repetitive peak anode current	$t_p = 10\text{ }\mu\text{s}$ $\delta = 0.01$	–	2.5	A
$I_{ASM}$	non-repetitive peak anode current	$t_p = 10\text{ }\mu\text{s}$ $T_j = 150\text{ °C}$	–	3	A
$di_A/dt$	rate of rise of anode current	up to $I_A = 2.5\text{ A}$	–	20	A/ $\mu\text{s}$
$P_{tot}$	total power dissipation	up to $T_{amb} = 25\text{ °C}$	–	275	mW
$T_{stg}$	storage temperature range		–65	200	°C
$T_j$	junction temperature		–	150	°C
$T_{amb}$	ambient operating temperature range		–65	150	°C

### THERMAL RESISTANCE

SYMBOL	PARAMETER	MAX.	UNIT
$R_{th\ j-a}$	from junction to ambient in free air	450	K/W

### EXPLANATION OF SYMBOLS

For application of the BRY39 as a programmable unijunction transistor, only the anode gate is used. To simplify the symbols, the term gate, instead of anode gate, will be used (see Fig.2).

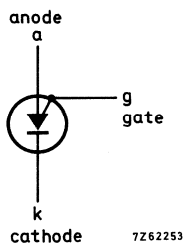

Fig.2 Explanation of symbols.



# Programmable unijunction transistor

## BRY39

### CHARACTERISTICS

$T_{amb} = 25\text{ }^{\circ}\text{C}$  unless otherwise specified.

SYMBOL	PARAMETER	CONDITIONS	MIN.	TYP.	MAX.	UNIT
$I_{(P)}$	peak point current (see Figs 3 and 8)	$V_S = 10\text{ V}$ $R_G = 10\text{ k}\Omega$	-	-	0.2	$\mu\text{A}$
		$V_S = 10\text{ V}$ $R_G = 100\text{ k}\Omega$	-	-	0.06	$\mu\text{A}$
$I_{(V)}$	valley point current (see Figs 3 and 8)	$V_S = 10\text{ V}$ $R_G = 10\text{ k}\Omega$	-	-	2	$\mu\text{A}$
		$V_S = 10\text{ V}$ $R_G = 100\text{ k}\Omega$	-	-	1	$\mu\text{A}$
$V_{offset}$	offset voltage (for $V_P$ and $V_S$ , see Fig.8)	typical curve $I_A = 0$	-	$V_P - V_S$	-	V
$I_{GAO}$	gate-anode leakage current	$I_K = 0$ $V_{GA} = 70\text{ V}$	-	-	10	nA
$I_{GKS}$	gate-cathode leakage current	$V_{AK} = 0$ $V_{KG} = 70\text{ V}$	-	-	100	nA
$V_{AK}$	anode-cathode voltage	$I_A = 100\text{ mA}$	-	-	1.4	V
$V_{OM}$	peak output voltage (see Figs 9 and 10)	$V_{AA} = 20\text{ V}$ $C = 10\text{ nF}$	6	-	-	V
$t_r$	rise time (see Fig.10)	$V_{AA} = 20\text{ V}$ $C = 10\text{ nF}$	-	-	80	ns

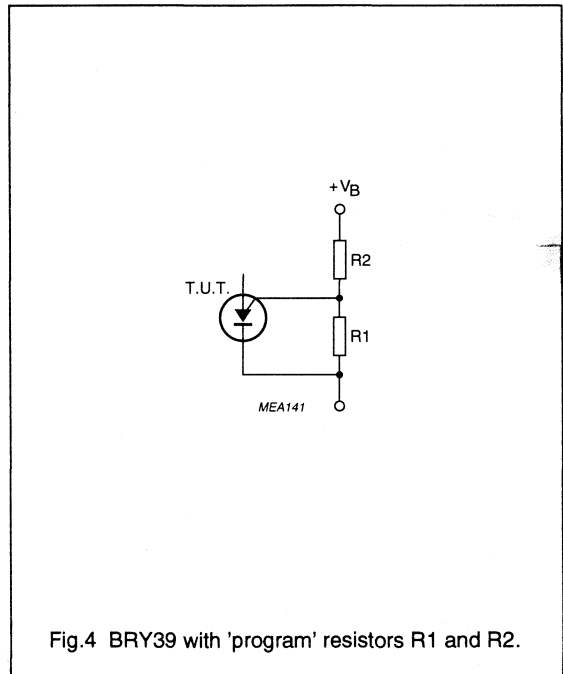
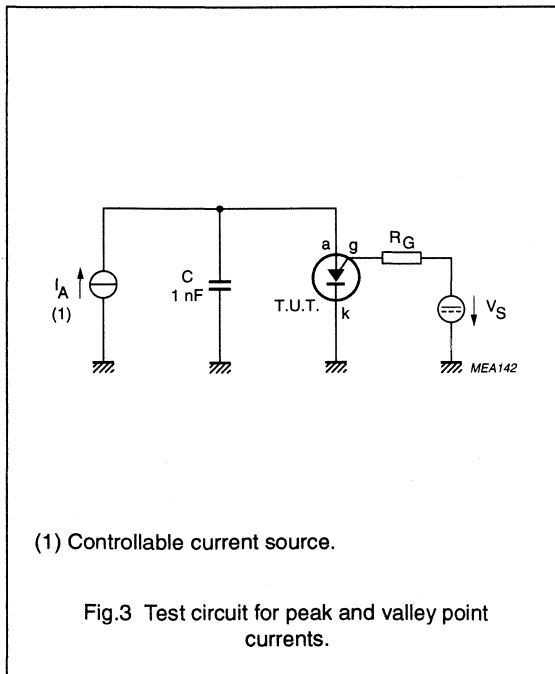

# Programmable unijunction transistor

**BRY39**

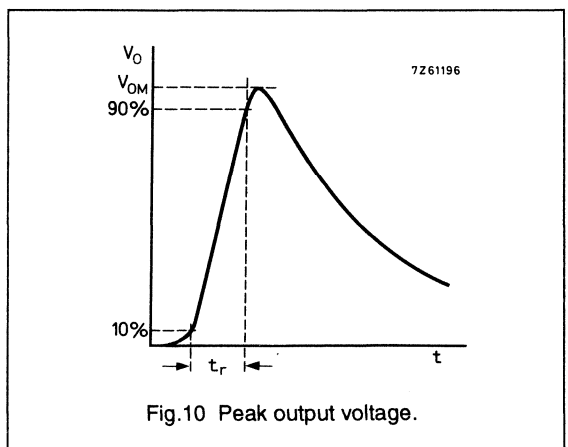
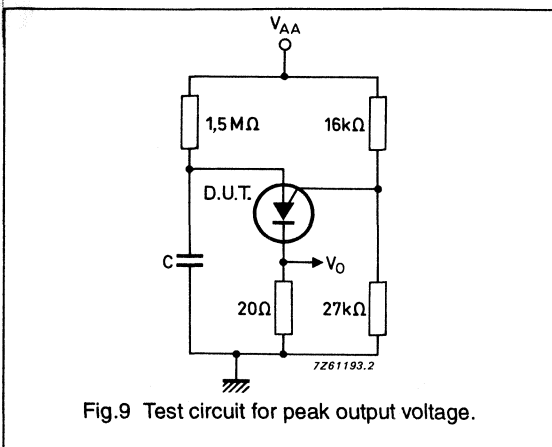
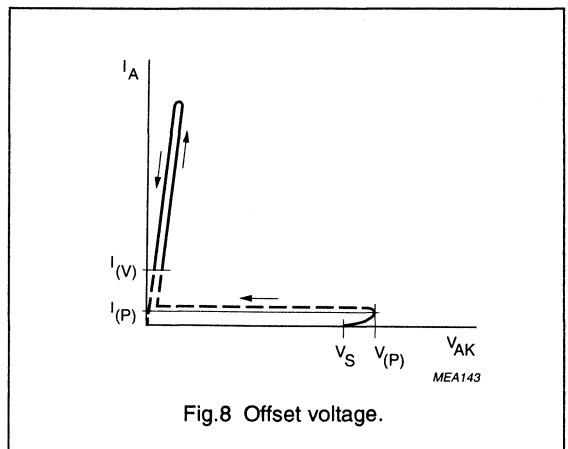
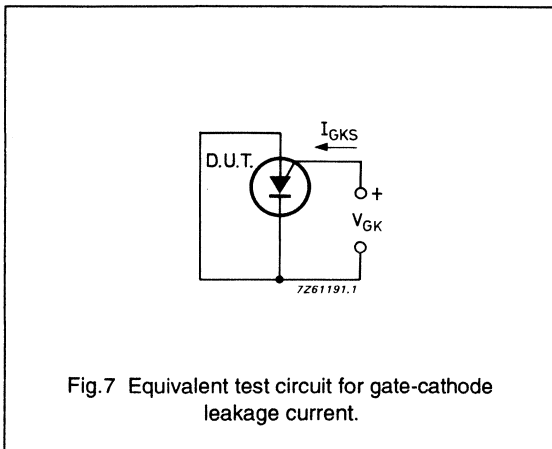
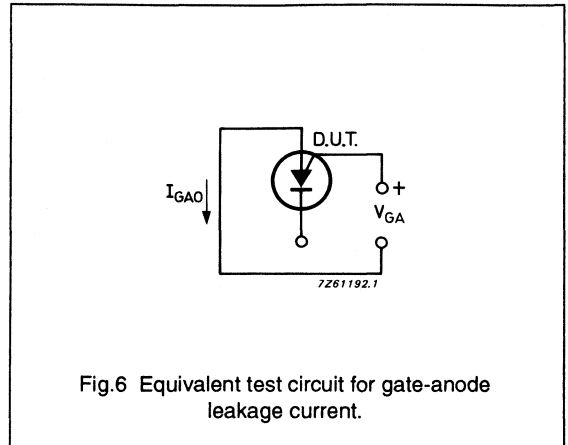
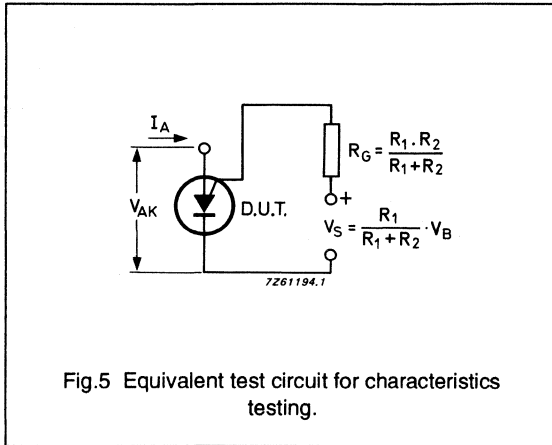

**Programmable unijunction transistor**

**BRY39**

**PACKAGE OUTLINE**

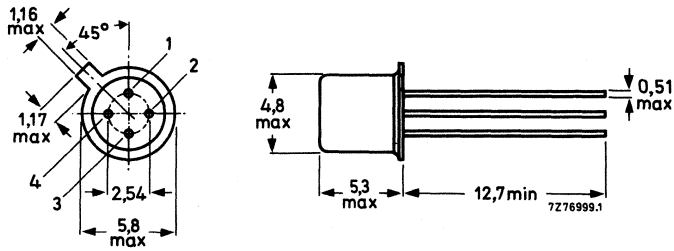

Dimensions in mm.

Fig.11 TO-72.



Data sheet	
status	Preliminary specification
date of issue	December 1990

# BRY39

## Silicon controlled switch

### DESCRIPTION

A silicon planar pnpn switch in a TO-72 metal envelope, intended for use in switching applications. It is an integrated pnp/npn transistor pair, with all electrodes accessible.

### PINNING - TO-72

Collector of the npn transistor (ag, anode gate) connected to case.

PIN	DESCRIPTION
1	cathode
2	cathode gate
3	anode gate
4	anode

### ACCESSORIES

56246 (distance disc).

### QUICK REFERENCE DATA

SYMBOL	PARAMETER	CONDITIONS	TYP.	MAX.	UNIT
<b>PNP transistor</b>					
$-V_{EBO}$	emitter-base voltage		-	70	V
<b>NPN transistor</b>					
$V_{CBO}$	collector-base voltage		-	70	V
$-I_{ERM}$	repetitive peak emitter current		-	2.5	A
$P_{tot}$	total power dissipation	up to $T_{amb} = 25\text{ }^{\circ}\text{C}$	-	275	mW
$T_j$	operating junction temperature		-	150	$^{\circ}\text{C}$
$V_{AK}$	forward on-state voltage	$I_A = 50\text{ mA}$ $I_{AG} = 0$ $R_{KG-K} = 10\text{ k}\Omega$	-	1.4	V
$I_H$	holding current	$I_{AG} = 10\text{ mA}$ $-V_{BB} = 2\text{ V}$ $R_{KG-K} = 10\text{ k}\Omega$	-	1	mA
$t_{on}$	turn-on time		-	0.25	$\mu\text{s}$
$t_{off}$	turn-off time		15	-	$\mu\text{s}$

### PIN CONFIGURATION

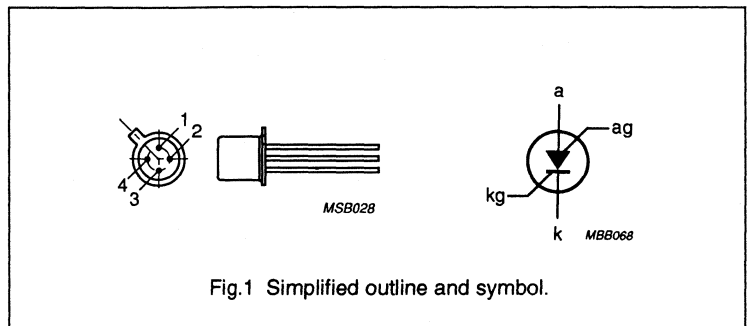

Fig.1 Simplified outline and symbol.

Silicon controlled switch

BRY39

TEST CIRCUITS

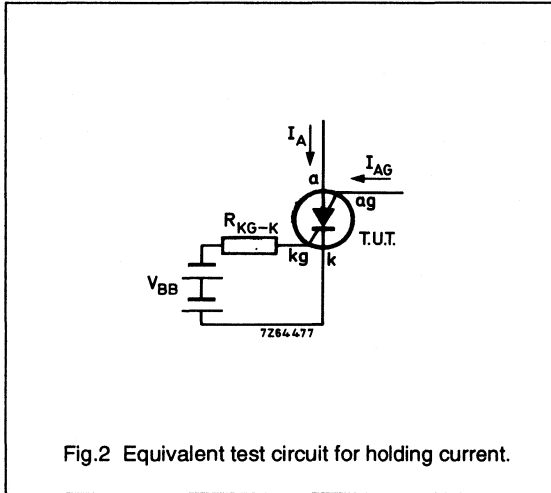

Fig.2 Equivalent test circuit for holding current.

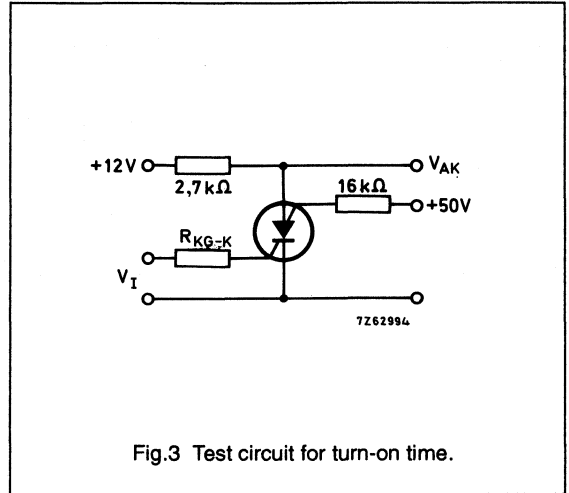

Fig.3 Test circuit for turn-on time.

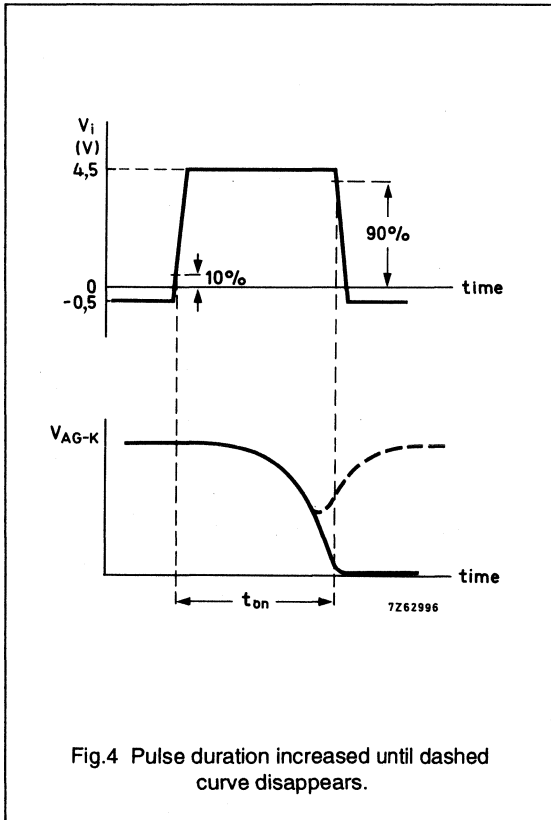

Fig.4 Pulse duration increased until dashed curve disappears.

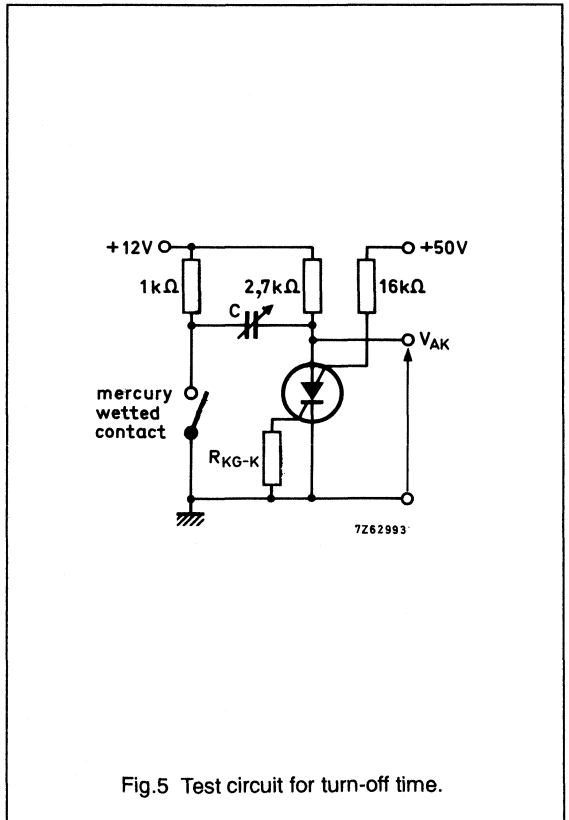
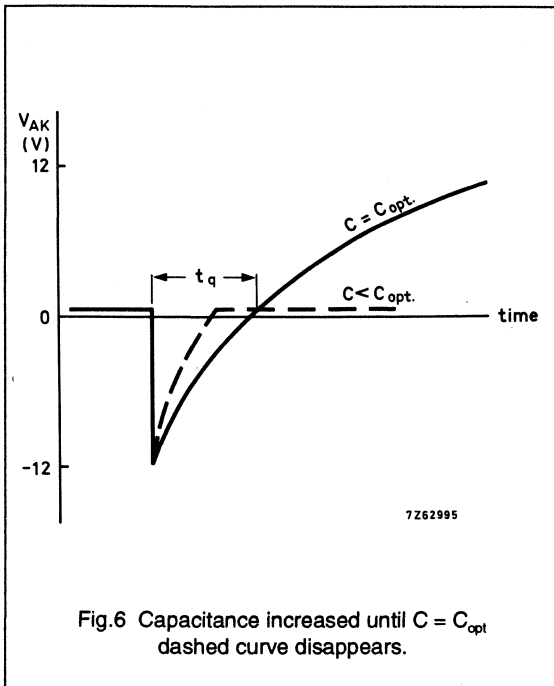

Fig.5 Test circuit for turn-off time.

## Silicon controlled switch

BRY39



## Silicon controlled switch

BRY39

## LIMITING VALUES

In accordance with the Absolute Maximum System (IEC 134).

SYMBOL	PARAMETER	CONDITIONS	MIN.	MAX.	UNIT
$V_{CBO}$	collector-base voltage	open emitter	–	–70	V
	pnp nnp		–	70	V
$V_{CER}$	collector-emitter voltage	$R_{BE} = 10 \text{ k}\Omega$	–	–	
	pnp nnp		–	70	V
$V_{CEO}$	collector-emitter voltage	open base	–	–70	V
	pnp nnp		–	–	
$V_{EBO}$	emitter-base voltage	open collector	–	–70	V
	pnp nnp		–	5	V
$I_C$	collector current (note 1)	DC value	–	–	
	pnp nnp		–	175	mA
$I_{CM}$	collector current (note 2)	peak value	–	–	
	pnp nnp		–	175	mA
$I_E$	emitter current	DC value	–	175	mA
	pnp nnp		–	–175	mA
$I_{ERM}$	repetitive peak emitter current	$t_p = 10 \text{ }\mu\text{s}$ $\delta = 0.01$	–	2.5	A
	pnp nnp		–	–2.5	A
$P_{tot}$	total power dissipation	up to $T_{amb} = 25 \text{ }^\circ\text{C}$	–	275	mW
$T_{stg}$	storage temperature range		–65	200	$^\circ\text{C}$
$T_j$	junction temperature		–	150	$^\circ\text{C}$
$T_{amb}$	ambient operating temperature range		–65	150	$^\circ\text{C}$

## Notes

1. Provided the  $I_E$  rating is not exceeded.
2. During switch-on, the device can withstand the discharge of a capacitor of maximum value of 500 pF. This capacitor is charged when the transistor is in cut-off condition, with a collector supply voltage of 160 V and a series resistance of 100 k $\Omega$ .

## THERMAL RESISTANCE

SYMBOL	PARAMETER	MAX.	UNIT
$R_{th \text{ } j-a}$	from junction to ambient in free air	450	K/W



## Silicon controlled switch

BRY39

## CHARACTERISTICS

 $T_{amb} = 25\text{ }^{\circ}\text{C}$  unless otherwise specified.

SYMBOL	PARAMETER	CONDITIONS	MIN.	TYP.	MAX.	UNIT
<b>Individual npn transistor</b>						
$I_{CER}$	collector cut-off current	$V_{CE} = 70\text{ V}$ $R_{BE} = 10\text{ k}\Omega$	–	–	100	nA
		$V_{CE} = 70\text{ V}$ $R_{BE} = 10\text{ k}\Omega$ $T_j = 150\text{ }^{\circ}\text{C}$	–	–	10	$\mu\text{A}$
$I_{EBO}$	emitter cut-off current	$V_{EB} = 5\text{ V}$ $I_C = 0$ $T_j = 150\text{ }^{\circ}\text{C}$	–	–	10	$\mu\text{A}$
$V_{CEsat}$	collector-emitter saturation voltage	$I_C = 10\text{ mA}$ $I_B = 1\text{ mA}$	–	–	500	mV
$V_{BEsat}$	base-emitter saturation voltage	$I_C = 10\text{ mA}$ $I_B = 1\text{ mA}$	–	–	900	mV
$h_{FE}$	DC current gain	$I_C = 10\text{ mA}$ $V_{CE} = 2\text{ V}$	50	–	–	
$f_T$	transition frequency	$I_C = 10\text{ mA}$ $V_{CE} = 2\text{ V}$ $f = 100\text{ MHz}$	–	170	–	MHz
$C_c$	collector capacitance	$I_E = I_e = 0$ $V_{CB} = 20\text{ V}$	–	–	5	pF
$C_e$	emitter capacitance	$I_E = I_e = 0$ $V_{EB} = 1\text{ V}$	–	–	25	pF
<b>Individual pnp transistor</b>						
$-I_{CEO}$	collector cut-off current	$-V_{CE} = 70\text{ V}$ $I_B = 0$ $T_j = 150\text{ }^{\circ}\text{C}$	–	–	10	$\mu\text{A}$
$-I_{EBO}$	emitter cut-off current	$-V_{EB} = 70\text{ V}$ $I_C = 0$ $T_j = 150\text{ }^{\circ}\text{C}$	–	–	10	$\mu\text{A}$
$h_{FE}$	DC current gain	$I_E = 1\text{ mA}$ $V_{CB} = 0$	–	5	–	
<b>Combined device</b>						
$V_{AK}$	forward on-state voltage	$R_{KG-K} = 10\text{ k}\Omega$ $I_A = 50\text{ mA}$ $I_{AG} = 0$	–	–	1.4	V
		$R_{KG-K} = 10\text{ k}\Omega$ $I_A = 50\text{ mA}$ $I_{AG} = 0$ $T_j = -55\text{ }^{\circ}\text{C}$	–	–	1.9	V
		$R_{KG-K} = 10\text{ k}\Omega$ $I_A = 1\text{ mA}$ $I_{AG} = 10\text{ mA}$	–	–	1.2	V

# Silicon controlled switch

# BRY39

SYMBOL	PARAMETER	CONDITIONS	MIN.	TYP.	MAX.	UNIT
$I_H$	holding current (see Fig.2)	$R_{KG-K} = 10\text{ k}\Omega$ $I_{AG} = 10\text{ mA}$ $-V_{BB} = 2\text{ V}$	-	-	1	mA
<b>Switching times</b>						
$t_{on}$	turn-on time	$V_{KG-K} = -0.5\text{ to }4.5\text{ V}$ $R_{KG-K} = 1\text{ k}\Omega$	-	-	0.25	$\mu\text{s}$
		$V_{KG-K} = -0.5\text{ to }4.5\text{ V}$ $R_{KG-K} = 10\text{ k}\Omega$	-	-	1.5	$\mu\text{s}$
$t_{off}$	turn-off time	$R_{KG-K} = 10\text{ k}\Omega$	-	15	-	$\mu\text{s}$

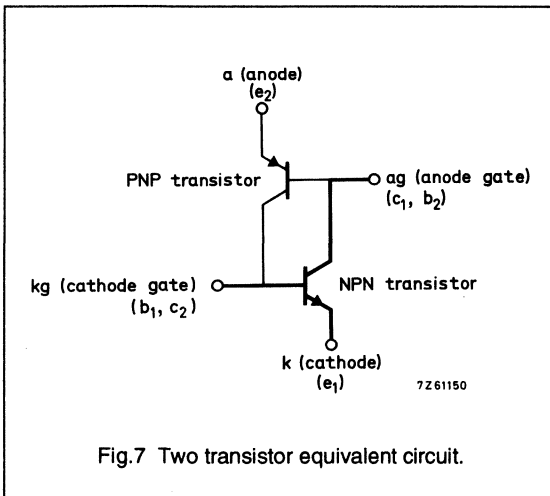

Fig.7 Two transistor equivalent circuit.

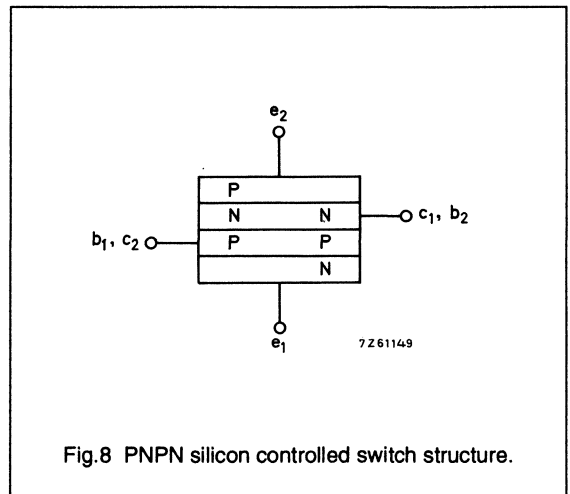

Fig.8 PNPN silicon controlled switch structure.

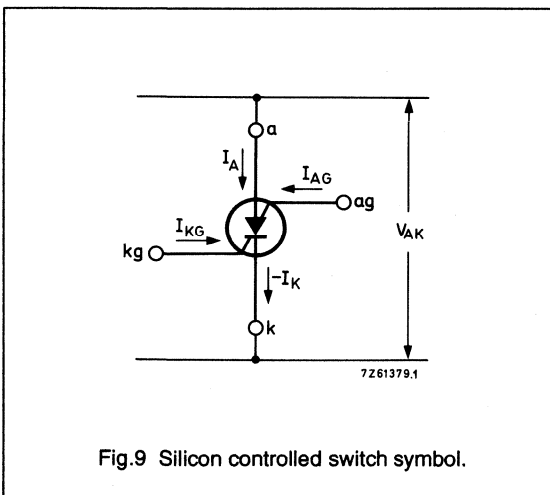
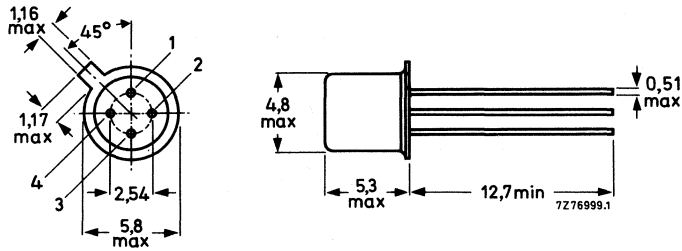

Fig.9 Silicon controlled switch symbol.

# Silicon controlled switch

# BRY39

## PACKAGE OUTLINE



Dimensions in mm.

Fig.10 TO-72.





## PROGRAMMABLE UNIJUNCTION TRANSISTOR

Silicon planar PNP trigger device in a plastic TO-92 envelope, intended for use in switching applications such as motor control, oscillators, relay replacement, timers, pulse shaper etc.

### QUICK REFERENCE DATA

Gate-anode voltage	$V_{GA}$	max.	70 V
Anode current (average)	$I_{A(AV)}$	max.	175 mA
Total power dissipation up to $T_{amb} = 75\text{ }^{\circ}\text{C}$	$P_{tot}$	max.	300 mW
Junction temperature	$T_j$	max.	150 $^{\circ}\text{C}$
Peak point current $V_S = 10\text{ V}; R_G = 10\text{ k}\Omega$	$I_P$	max.	0.2 $\mu\text{A}$
Valley point current $V_S = 10\text{ V}; R_G = 10\text{ k}\Omega$	$I_V$	min.	2 $\mu\text{A}$

### MECHANICAL DATA

Dimensions in mm

Fig. 1 TO-92.

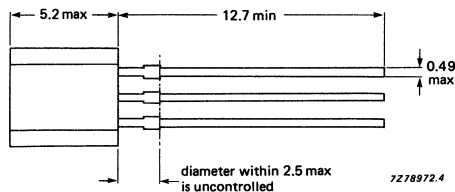
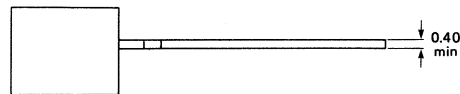
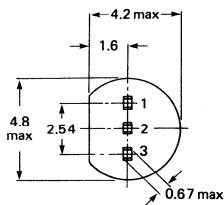
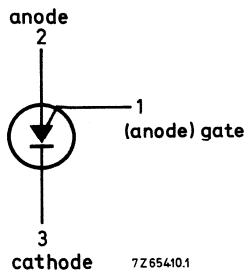

Capability approved to CECC NECC-C-002

A and B selections are available on request.

**RATINGS**

Limiting values in accordance with the Absolute Maximum System (IEC 134)

Gate-anode voltage	$V_{GA}$	max.	70 V
Anode current (average)	$I_{A(AV)}$	max.	175 mA
Repetitive peak anode current $t_p = 10 \mu s; \delta = 0,01$	$I_{ARM}$	max.	2,5 A
Non-repetitive peak anode current $t_p = 10 \mu s$	$I_{ASM}$	max.	3,0 A
Rate of rise of anode current up to $I_A = 2,5 A$	$\frac{dI_A}{dt}$	max.	20 A/ $\mu s$
Total power dissipation up to $T_{amb} = 75 \text{ }^\circ C$	$P_{tot}$	max.	300 mW
Storage temperature	$T_{stg}$		-65 to + 150 $^\circ C$
Junction temperature	$T_j$	max.	150 $^\circ C$

**THERMAL RESISTANCE**

From junction to ambient in free air	$R_{th j-a}$	=	250 K/W
--------------------------------------	--------------	---	---------

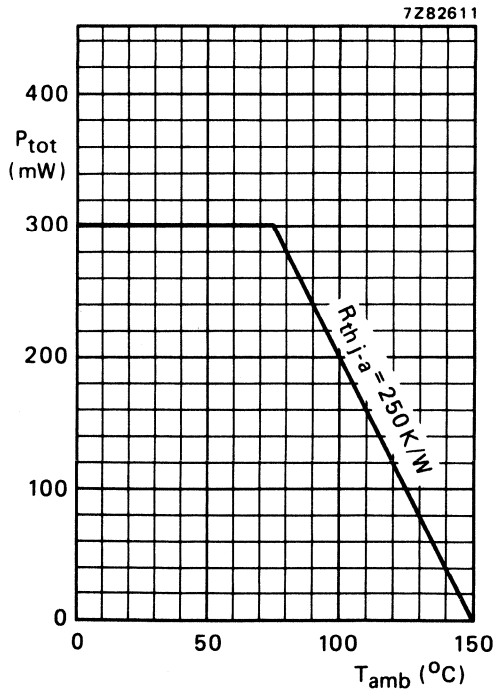

Fig. 2 Maximum permissible power dissipation as a function of ambient temperature.

**CHARACTERISTICS**

$T_{amb} = 25\text{ }^{\circ}\text{C}$

Peak point current (see Fig. 10)

$V_S = 10\text{ V}; R_G = 10\text{ k}\Omega$

$I_p$  max.  $0.2\text{ }\mu\text{A}$

$V_S = 10\text{ V}; R_G = 100\text{ k}\Omega$

$I_p$  max.  $0.06\text{ }\mu\text{A}$

Valley point current (see Fig. 10)

$V_S = 10\text{ V}; R_G = 10\text{ k}\Omega$

$I_V$  min.  $2\text{ }\mu\text{A}$

$V_S = 10\text{ V}; R_G = 100\text{ k}\Omega$

$I_V$  min.  $1\text{ }\mu\text{A}$

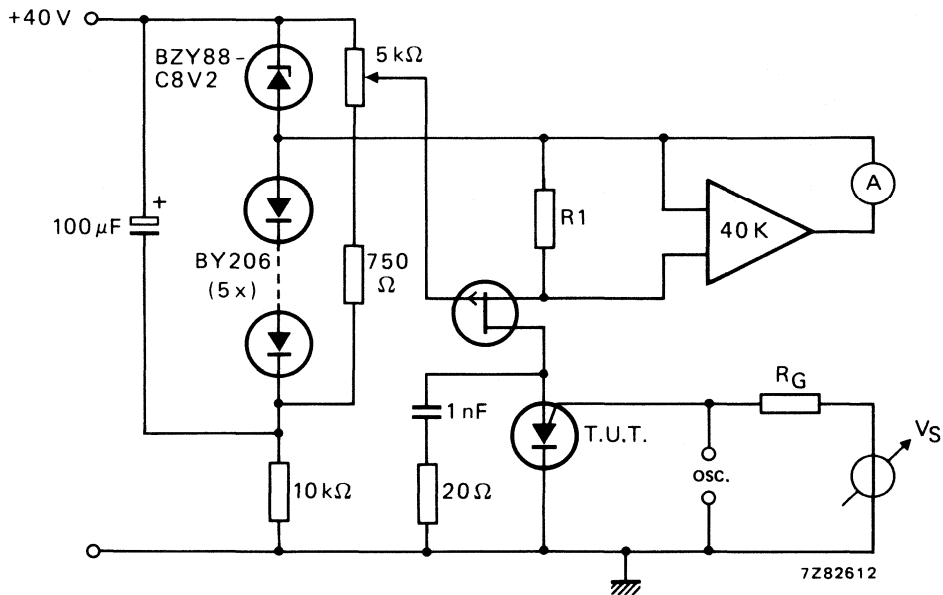

Fig. 3 Measuring circuit for  $I_p$  and  $I_V$  by means of value of  $R_1$ .  $R_1 = \frac{1}{I_A}$  (that is maximum voltage drop over  $R_1$  is 1 V). Internal resistance of oscilloscope is  $10\text{ M}\Omega$ .

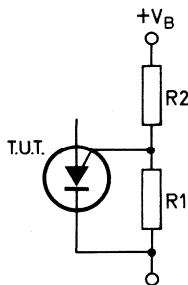

Fig. 4 BRY56 with "program" resistors  $R_1$  and  $R_2$ .

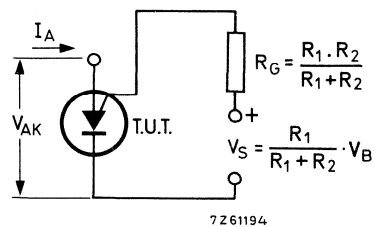

Fig. 5 Equivalent test circuit for characteristics testing.

Gate-anode leakage current (see Fig. 6)

$I_K = 0; V_{GA} = 70 \text{ V}$

$I_{GAO} \text{ max. } 10 \text{ nA}$

Gate-cathode leakage current (see Fig. 7)

$V_{AK} = 0; V_{GK} = 70 \text{ V}$

$I_{GKS} \text{ max. } 100 \text{ nA}$

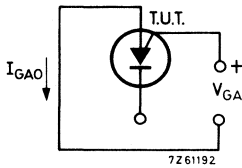

Fig. 6.

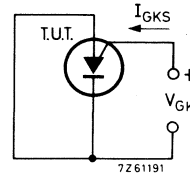

Fig. 7.

Anode-cathode voltage

$I_A = 100 \text{ mA}$

$V_{AK} \text{ max. } 1.4 \text{ V}$

Peak output voltage (see Figs 8 and 9)

$V_{AA} = 20 \text{ V}; C = 10 \text{ nF}$

$V_{OM} \text{ min. } 6 \text{ V}$

Offset voltage (see Fig. 10)  $V_{\text{offset}} = V_P - V_S (I_A = 0)$

Rise time (see Fig. 9)

$V_{AA} = 20 \text{ V}; C = 10 \text{ nF}$

$t_r \text{ max. } 80 \text{ ns}$

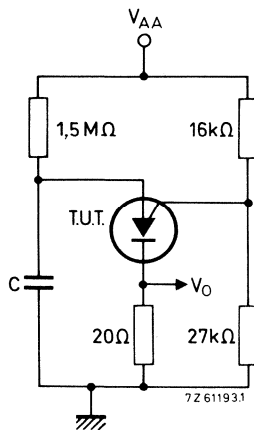

Fig. 8.

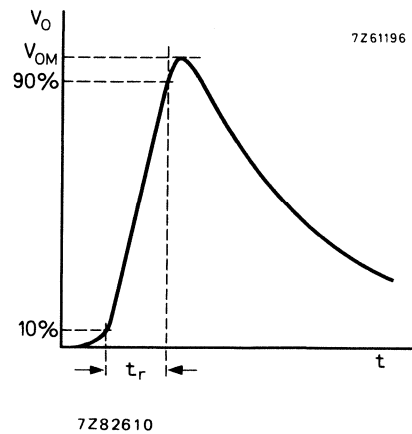

Fig. 9.

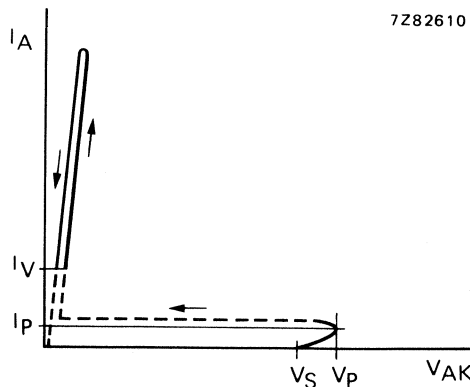

Fig. 10.





## N-P-N DARLINGTON TRANSISTORS

Silicon planar transistors in plastic TO-92 envelopes, intended for industrial switching applications e.g. print hammer, solenoid, relay and lamp driving.

P-N-P complements are the BSR60, BSR61 and BSR62.

### QUICK REFERENCE DATA

		BSR50	BSR51	BSR52	
Collector-base voltage (open emitter)	$V_{CBO}$ max.	60	80	90	V
Collector-emitter voltage (see Fig. 5)	$V_{CER}$ max.	45	60	80	V
Collector current (average)	$I_{C(AV)}$ max.		1,0		A
Total power dissipation up to $T_{amb} = 25\text{ }^{\circ}\text{C}$	$P_{tot}$ max.		0,8		W
Junction temperature	$T_j$ max.		150		$^{\circ}\text{C}$
Collector-emitter saturation voltage $I_C = 0,5\text{ A}; I_B = 0,5\text{ mA}$	$V_{CEsat}$ <		1,3		V
D.C. current gain $I_C = 150\text{ mA}; V_{CE} = 10\text{ V}$	$h_{FE}$ >		1000		
$I_C = 500\text{ mA}; V_{CE} = 10\text{ V}$	$h_{FE}$ >		2000		
Turn-off time when switched from $I_{Con} = 500\text{ mA}; I_{Bon} = 0,5\text{ mA}$ to cut-off with $-I_{Boff} = 0,5\text{ mA}$	$t_{off}$ <		1,5		$\mu\text{s}$

### MECHANICAL DATA

Dimensions in mm

Fig. 1 TO-92. For circuit diagram, see Fig. 2.

#### Pinning

- 1 = base
- 2 = collector
- 3 = emitter

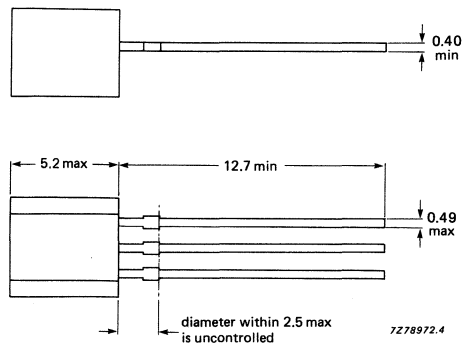
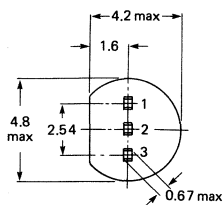

**RATINGS**

Limiting values in accordance with the Absolute Maximum System (IEC 134)

			BSR50	BSR51	BSR52	
Collector-base voltage (open emitter)	$V_{CBO}$	max.	60	80	90	V
Collector-emitter voltage (see Fig. 5)	$V_{CER}$	max.	45	60	80	V
Emitter-base voltage (open collector)	$V_{EBO}$	max.	5	5	5	V
Collector current (average)	$I_C(AV)$	max.		1,0		A
Collector current (peak value)	$I_{CM}$	max.		2,0		A
Base current (d.c.)	$I_B$	max.		0,1		A
Total power dissipation up to $T_{amb} = 25\text{ }^\circ\text{C}$	$P_{tot}$	max.		0,8		W
up to $T_{amb} = 25\text{ }^\circ\text{C}^*$	$P_{tot}$	max.		1,0		W
Storage temperature	$T_{stg}$		-65 to + 150			$^\circ\text{C}$
Junction temperature **	$T_j$	max.	150			$^\circ\text{C}$
<b>THERMAL RESISTANCE **</b>						
From junction to ambient in free air	$R_{th\ j-a}$	=	156			K/W

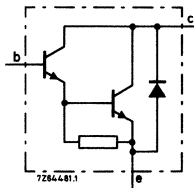

Fig. 2 Circuit diagram.

\* Transistor mounted on printed-circuit board, maximum lead length 3 mm, mounting pad for collector lead minimum 10 mm x 10 mm.

\*\* Based on maximum average junction temperature in line with common industrial practice. The resulting higher junction temperature of the output transistor part is taken into account.

## CHARACTERISTICS

 $T_j = 25\text{ }^\circ\text{C}$ 

Collector cut-off voltage

 $I_E = 0; V_{CB} = 45\text{ V}$ BSR50  $I_{CBO} < 50\text{ nA}$  $I_E = 0; V_{CB} = 60\text{ V}$ BSR51  $I_{CBO} < 50\text{ nA}$  $I_E = 0; V_{CB} = 80\text{ V}$ BSR52  $I_{CBO} < 50\text{ nA}$ 

Emitter cut-off current

 $I_C = 0; V_{EB} = 4\text{ V}$  $I_{EBO} < 50\text{ nA}$ 

Saturation voltages

 $I_C = 0,5\text{ A}; I_B = 0,5\text{ mA}$  $V_{CEsat} < 1,3\text{ V}$  $V_{BEsat} < 1,9\text{ V}$  $I_C = 1,0\text{ A}; I_B = 1,0\text{ mA}$ BSR51  $V_{CEsat} < 1,6\text{ V}$  $V_{BEsat} < 2,2\text{ V}$  $I_C = 1,0\text{ A}; I_B = 4,0\text{ mA}$ BSR50; BSR52  $V_{CEsat} < 1,6\text{ V}$  $V_{BEsat} < 2,2\text{ V}$ 

D.C. current gain

 $I_C = 150\text{ mA}; V_{CE} = 10\text{ V}$  $h_{FE} > 1000$  $I_C = 500\text{ mA}; V_{CE} = 10\text{ V}$  $h_{FE} > 2000$ Small-signal current gain at  $f = 35\text{ MHz}$  $I_C = 500\text{ mA}; V_{CE} = 5\text{ V}$  $h_{fe} \text{ typ. } 10$

Switching times (see Figs 3 and 4)

$I_{Con} = 500 \text{ mA}$ ;  $I_{Bon} = -I_{Boff} = 0,5 \text{ mA}$

Turn-on time

Turn-off time

$t_{on}$	typ.	0,4 $\mu\text{s}$
$t_{off}$	<	1,5 $\mu\text{s}$

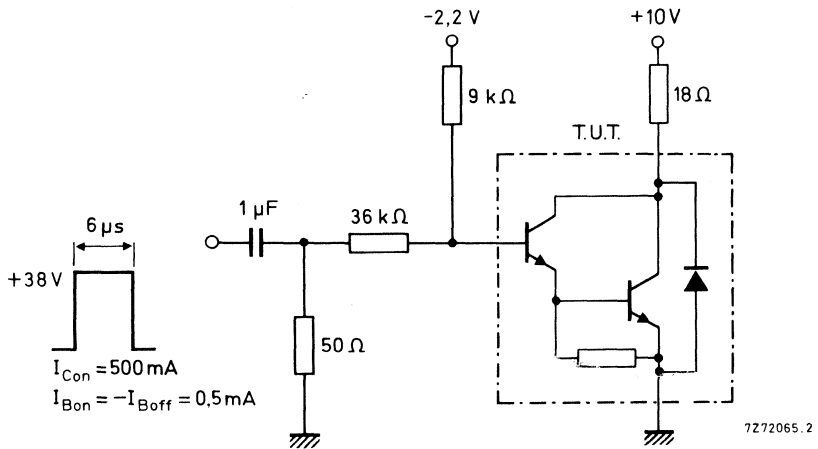

Fig. 3 Test circuit for 500 mA switching.

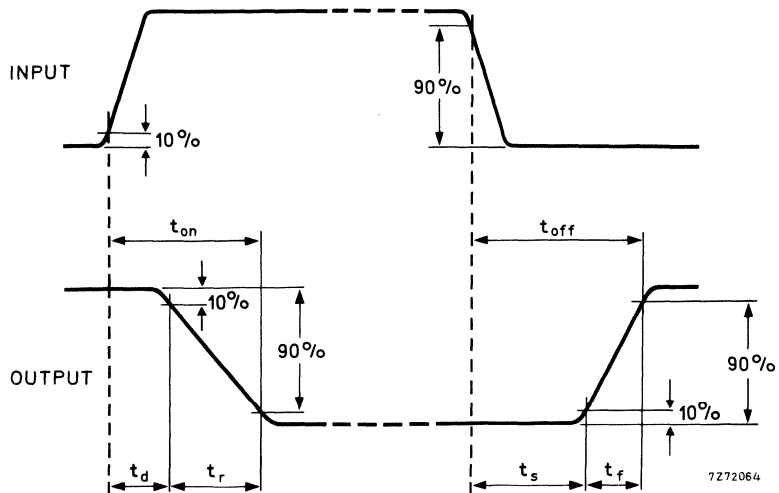
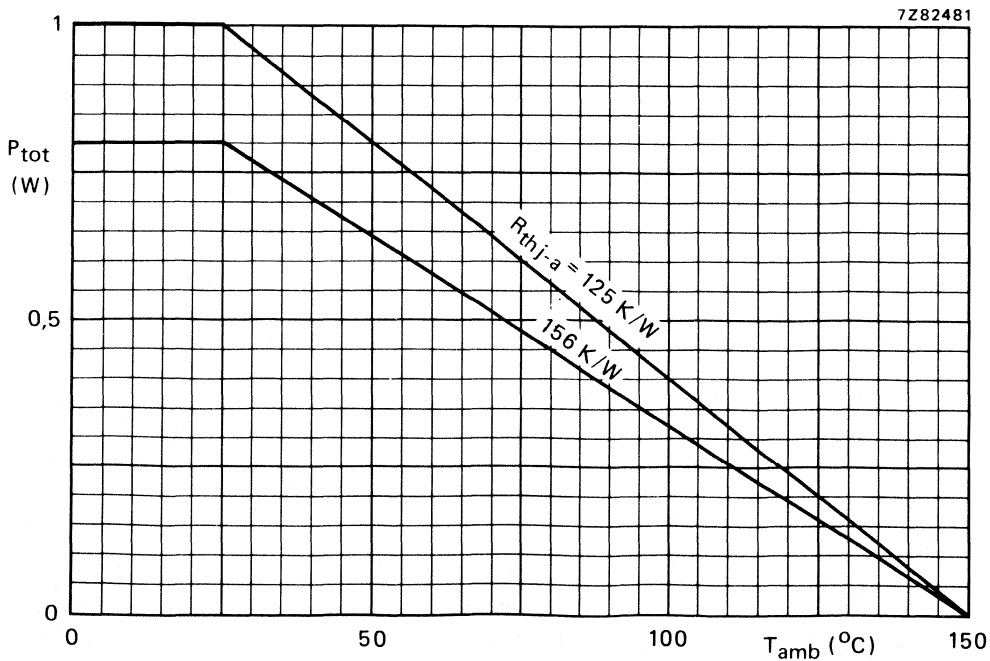
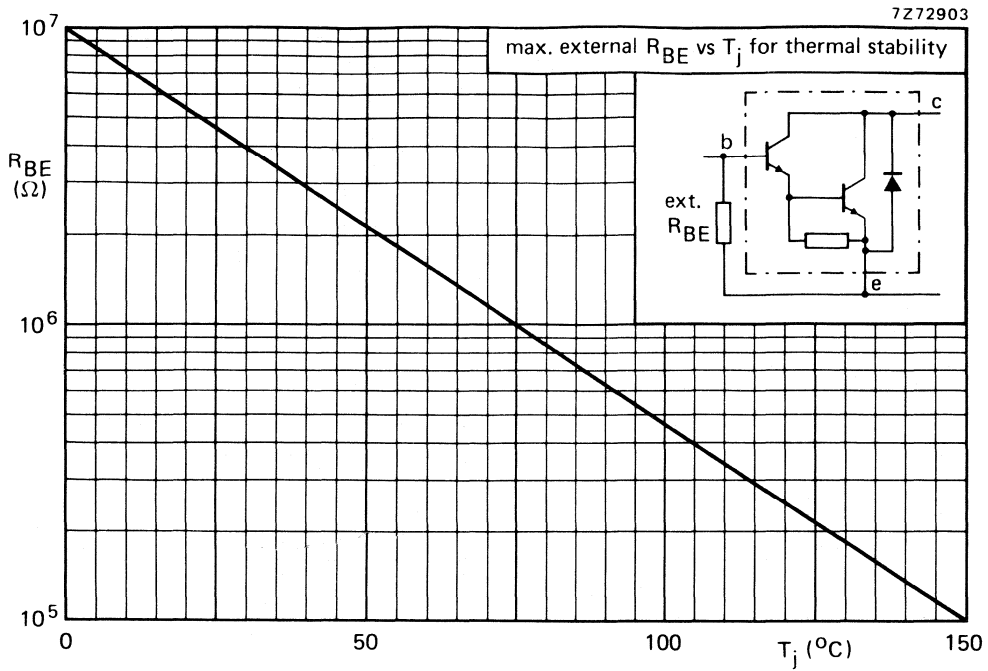

Fig. 4 Switching waveforms.



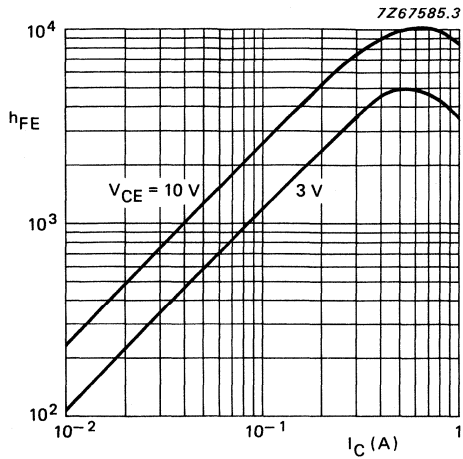

Fig. 7  $T_j = 25\text{ }^\circ\text{C}$ ; typical values.

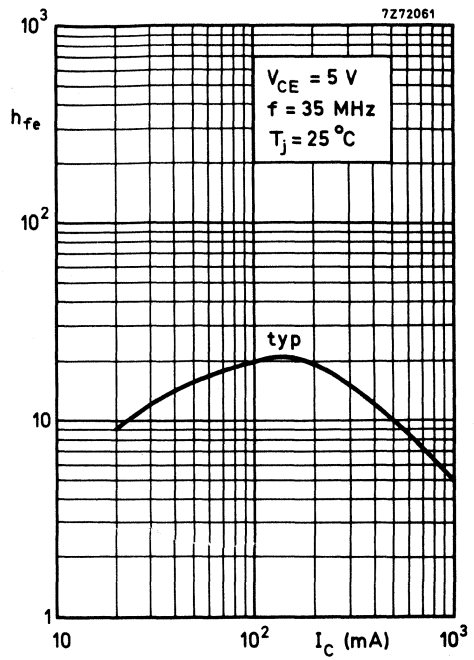

Fig. 8.



## P-N-P DARLINGTON TRANSISTORS

Silicon planar transistors in plastic TO-92 envelopes, intended for industrial applications e.g. print hammer, solenoid, relay and lamp driving.

N-P-N complements are the BSR50, BSR51 and BSR52.

### QUICK REFERENCE DATA

		BSR60	BSR61	BSR62	
Collector-base voltage (open emitter)	$-V_{CBO}$ max.	60	80	90	V
Collector-emitter voltage (see Fig. 6)	$-V_{CER}$ max.	45	60	80	V
Collector current (average)	$-I_{C(AV)}$ max.	1,0	1,0	1,0	A
Total power dissipation up to $T_{amb} = 25\text{ }^{\circ}\text{C}$	$P_{tot}$ max.	0,8	0,8	0,8	W
Junction temperature	$T_j$ max.	150	150	150	$^{\circ}\text{C}$
Collector-emitter saturation voltage $-I_C = 0,5\text{ A}; -I_B = 0,5\text{ mA}$	$-V_{CEsat}$ <	1,3	1,3	1,4	V
D.C. current gain					
$-I_C = 150\text{ mA}; -V_{CE} = 10\text{ V}$	$h_{FE} >$		1000		
$-I_C = 500\text{ mA}; -V_{CE} = 10\text{ V}$	$h_{FE} >$		2000		
Turn-off time when switched from $-I_{Con} = 500\text{ mA}; -I_{Bon} = 0,5\text{ mA}$ to cut-off with $+I_{Boff} = 0,5\text{ mA}$	$t_{off}$ <		1,5		$\mu\text{s}$

### MECHANICAL DATA

Dimensions in mm

Fig. 1 TO-92. For circuit diagram, see Fig. 2.

#### Pinning

- 1 = base
- 2 = collector
- 3 = emitter

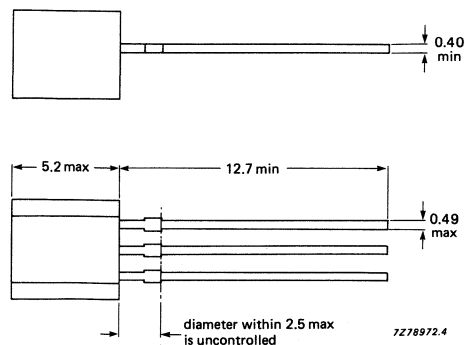
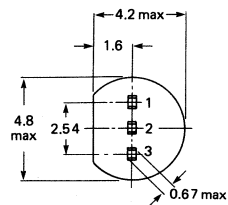

**RATINGS**

Limiting values in accordance with the Absolute Maximum System (IEC 134)

			BSR60	BSR61	BSR62	
Collector-base voltage (open emitter)	$-V_{CBO}$	max.	60	80	90	V
Collector-emitter voltage (see Fig. 6)	$-V_{CER}$	max.	45	60	80	V
Emitter-base voltage (open collector)	$-V_{EBO}$	max.	5	5	5	V
Collector current (average)	$-I_{C(AV)}$	max.	1,0			A
Collector current (peak value)	$-I_{CM}$	max.	2,0			A
Base current (d.c.)	$-I_B$	max.	0,1			A
Total power dissipation up to $T_{amb} = 25\text{ }^{\circ}\text{C}$	$P_{tot}$	max.	0,8			W
up to $T_{amb} = 25\text{ }^{\circ}\text{C}^*$	$P_{tot}$	max.	1,0			W
Storage temperature	$T_{stg}$		-65 to + 150			$^{\circ}\text{C}$
Junction temperature **	$T_j$	max.	150			$^{\circ}\text{C}$
<b>THERMAL RESISTANCE **</b>						
From junction to ambient in free air	$R_{th\ j-a}$	=	156			K/W

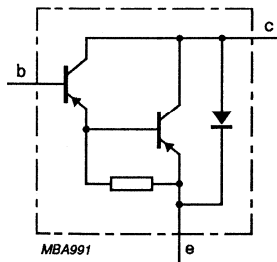

Fig. 2 Circuit diagram.

\* Transistor mounted on printed-circuit board, maximum lead length 3 mm, mounting pad for collector lead minimum 10 mm x 10 mm.

\*\* Based on maximum average junction temperature in line with common industrial practice. The resulting higher junction temperature of the output transistor part is taken into account.



## CHARACTERISTICS

 $T_j = 25\text{ }^\circ\text{C}$ 

Collector cut-off current

 $I_E = 0; -V_{CB} = 45\text{ V}$ BSR60  $-I_{CBO} < 50\text{ nA}$  $I_E = 0; -V_{CB} = 60\text{ V}$ BSR61  $-I_{CBO} < 50\text{ nA}$  $I_E = 0; -V_{CB} = 80\text{ V}$ BSR62  $-I_{CBO} < 50\text{ nA}$ 

Emitter cut-off current

 $I_C = 0; -V_{EB} = 4\text{ V}$  $-I_{EBO} < 50\text{ nA}$ 

Saturation voltages

 $-I_C = 0,5\text{ A}; -I_B = 0,5\text{ mA}$ BSR60; BSR61  $-V_{CEsat} < 1,3\text{ V}$  $-V_{BEsat} < 1,9\text{ V}$  $-I_C = 0,5\text{ A}; -I_B = 0,5\text{ mA}$ BSR62  $-V_{CEsat} < 1,4\text{ V}$  $-V_{BEsat} < 2,0\text{ V}$  $-I_C = 1,0\text{ A}; -I_B = 1,0\text{ mA}$ BSR61  $-V_{CEsat} < 1,6\text{ V}$  $-V_{BEsat} < 2,2\text{ V}$  $-I_C = 1,0\text{ A}; -I_B = 4,0\text{ mA}$ BSR60  $-V_{CEsat} < 1,6\text{ V}$  $-V_{BEsat} < 2,2\text{ V}$  $-I_C = 1,0\text{ A}; -I_B = 4,0\text{ mA}$ BSR62  $-V_{CEsat} < 1,8\text{ V}$  $-V_{BEsat} < 2,4\text{ V}$ 

D.C. current gain

 $-I_C = 150\text{ mA}; -V_{CE} = 10\text{ V}$  $h_{FE} > 1000$  $-I_C = 500\text{ mA}; -V_{CE} = 10\text{ V}$  $h_{FE} > 2000$ Small-signal current gain at  $f = 35\text{ MHz}$  $-I_C = 500\text{ mA}; -V_{CE} = 5\text{ V}$  $h_{fe}$  typ. 10

Switching times (see Figs 3 and 4)

$-I_{Con} = 500 \text{ mA}; -I_{Bon} = +I_{Boff} = 0,5 \text{ mA}$

Turn-on time

Turn-off time

$t_{on} < 1,0 \mu\text{s}$

$t_{off} < 1,5 \mu\text{s}$

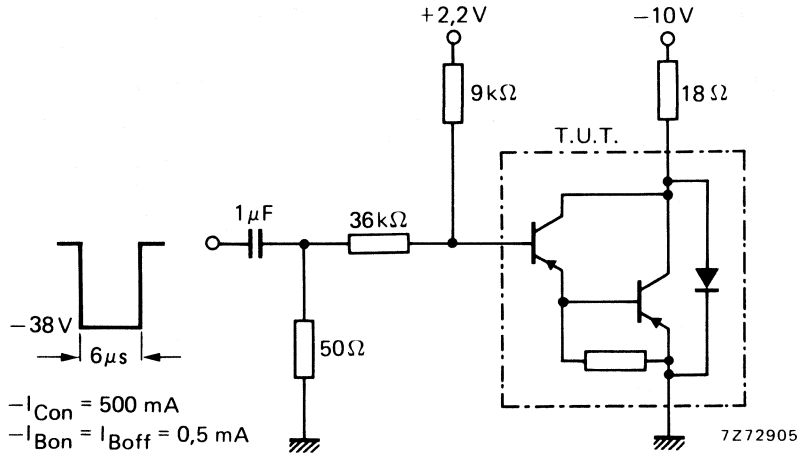

Fig. 3 Test circuit for 500 mA switching.

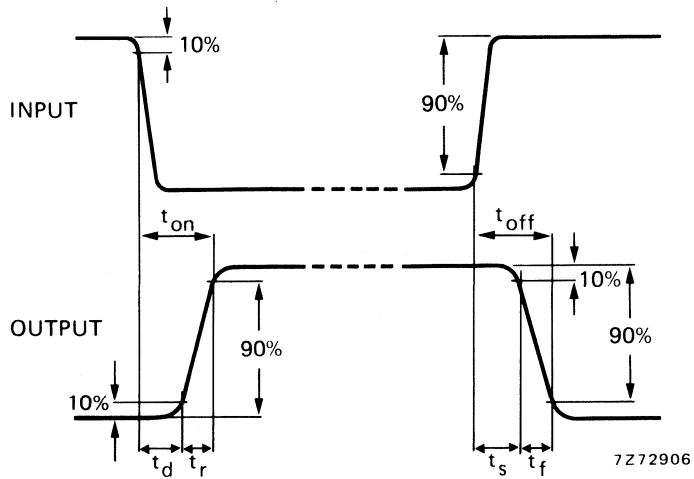
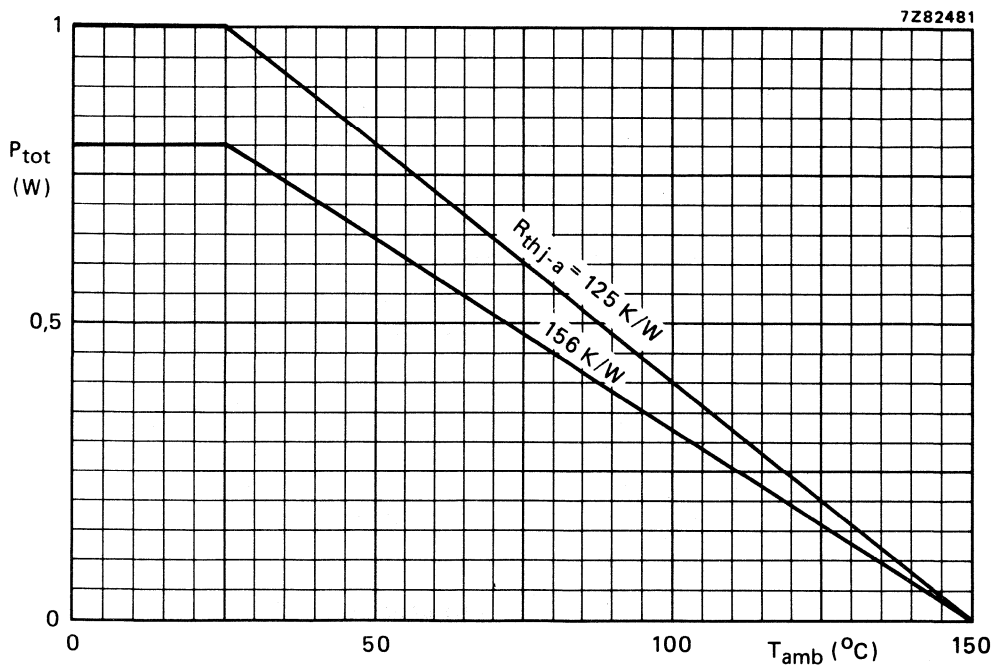
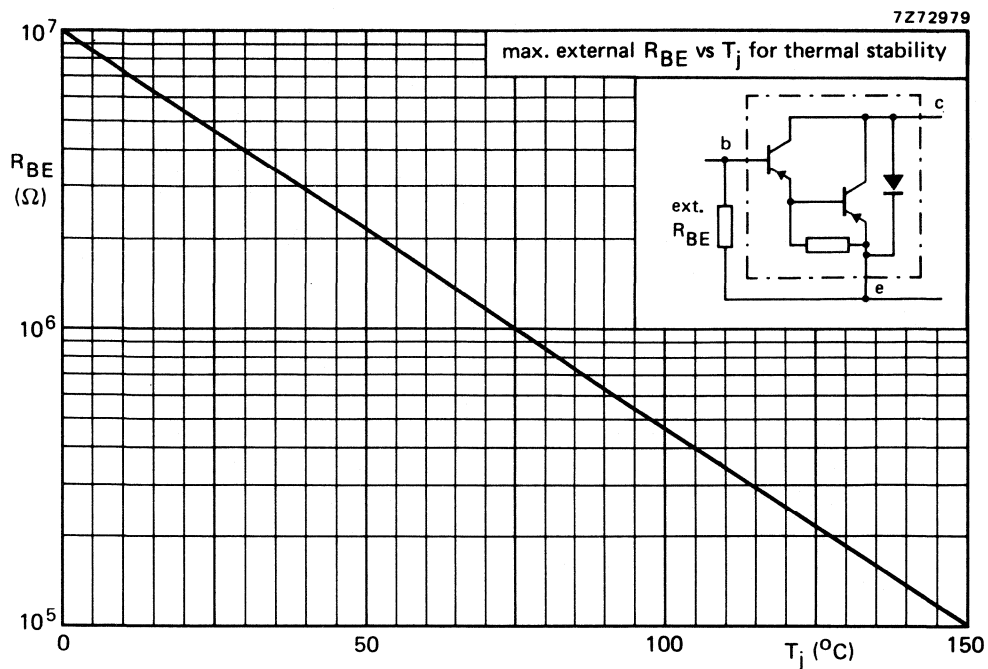

Fig. 4 Switching waveforms.



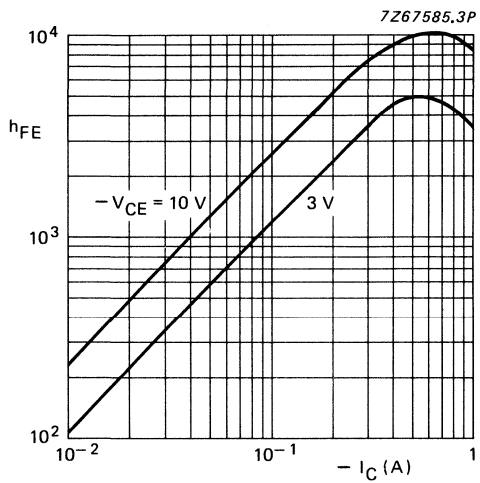

Fig. 7  $T_j = 25\text{ }^\circ\text{C}$ .

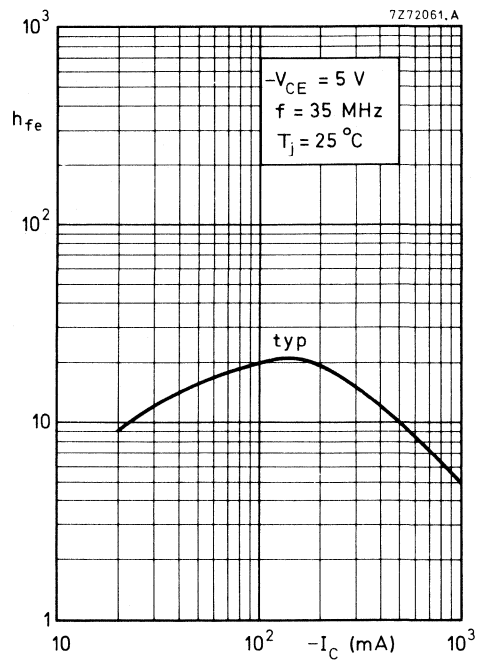

Fig. 8.



## SILICON PLANAR EPITAXIAL TRANSISTOR

N-P-N transistor in a plastic TO-92 envelope. It is primarily intended for general purpose switching and as driver for numerical indicator tubes.

### QUICK REFERENCE DATA

Collector-base voltage (open emitter)	$V_{CB0}$	max.	120 V
Collector-emitter voltage (open base)	$V_{CE0}$	max.	100 V
Collector current (peak value)	$I_{CM}$	max.	250 mA
Total power dissipation up to $T_{amb} = 25\text{ }^{\circ}\text{C}$	$P_{tot}$	max.	500 mW
Junction temperature	$T_j$	max.	150 $^{\circ}\text{C}$
D.C. current gain	$h_{FE}$	>	20
$I_C = 4\text{ mA}; V_{CE} = 1\text{ V}$		typ.	80
Transition frequency at $f = 35\text{ MHz}$	$f_T$	>	60 MHz
$I_C = 4\text{ mA}; V_{CE} = 10\text{ V}$			
Turn-off time	$t_{off}$	<	1 $\mu\text{s}$
$I_{Con} = 15\text{ mA}; I_{Bon} = 1\text{ mA}; -I_{Boff} = 1\text{ mA}$			

### Note

The BSS38 may be operated in the breakdown region up to  $V_{CE} = 160\text{ V}$ , provided  $P_{tot}$  at  $T_{amb} = 85\text{ }^{\circ}\text{C}$  does not exceed 100 mW.

### MECHANICAL DATA

Dimensions in mm

Fig. 1 TO-92.

### Pinning

- 1 = emitter
- 2 = base
- 3 = collector

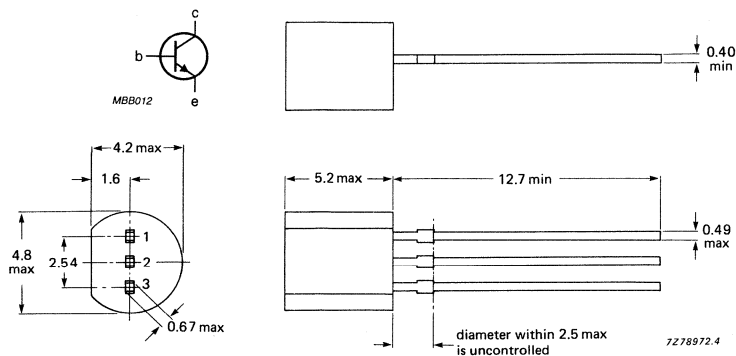

**RATINGS**

Limiting values in accordance with the Absolute Maximum System (IEC 134)

Collector-base voltage (open emitter)	$V_{CBO}$	max.	120 V*
Collector-emitter voltage (open base)	$V_{CEO}$	max.	100 V*
Emitter-base voltage (open collector)	$V_{EBO}$	max.	5 V
Collector current (d.c. or averaged over any 20 ms period)	$I_C(AV)$	max.	100 mA
Collector current (peak value)	$I_{CM}$	max.	250 mA
Total power dissipation up to $T_{amb} = 25\text{ }^\circ\text{C}$	$P_{tot}$	max.	500 mW
Storage temperature	$T_{stg}$		-65 to + 150 $^\circ\text{C}$
Junction temperature	$T_j$	max.	150 $^\circ\text{C}$

**THERMAL RESISTANCE**

From junction to ambient in free air	$R_{th\ j-a}$	=	0,25 $^\circ\text{C}/\text{mW}$
--------------------------------------	---------------	---	---------------------------------

**CHARACTERISTICS**

$T_j = 25\text{ }^\circ\text{C}$  unless otherwise specified

Collector cut-off current

$I_E = 0; V_{CB} = 90\text{ V}$	$I_{CBO}$	<	200 nA
$I_E = 0; V_{CB} = 90\text{ V}; T_j = 150\text{ }^\circ\text{C}$	$I_{CBO}$	<	50 $\mu\text{A}$
$V_{BE} = 0; V_{CE} = 80\text{ V}; T_j = 85\text{ }^\circ\text{C}$	$I_{CES}$	<	20 $\mu\text{A}$

Emitter cut-off current

$I_C = 0; V_{EB} = 4\text{ V}$	$I_{EBO}$	<	200 nA
$I_C = 0; V_{EB} = 4\text{ V}; T_j = 150\text{ }^\circ\text{C}$	$I_{EBO}$	<	50 $\mu\text{A}$

Saturation voltages

$I_C = 4\text{ mA}; I_B = 0,4\text{ mA}$	$V_{CEsat}$	<	0,7 V
$I_C = 50\text{ mA}; I_B = 15\text{ mA}$	$V_{BEsat}$	<	1,2 V
	$V_{CESat}$	<	3,0 V

D.C. current gain

$I_C = 4\text{ mA}; V_{CE} = 1\text{ V}$	$h_{FE}$	>	20
		typ.	80
$I_C = 10\text{ mA}; V_{CE} = 1\text{ V}$	$h_{FE}$	typ.	80

\* The BSS38 may be operated in the breakdown region up to  $V_{CE} = 160\text{ V}$ , provided  $P_{tot}$  at  $T_{amb} = 85\text{ }^\circ\text{C}$  does not exceed 100 mW.

**CHARACTERISTICS (continued)**Transition frequency at  $f = 35 \text{ MHz}$ 

$$I_C = 4 \text{ mA}; V_{CE} = 10 \text{ V}$$

$$f_T > 60 \text{ MHz}$$

Collector capacitance at  $f = 1 \text{ MHz}$ 

$$I_E = I_e = 0; V_{CB} = 10 \text{ V}$$

$$C_c < 4,5 \text{ pF}$$

Emitter capacitance at  $f = 1 \text{ MHz}$ 

$$I_C = I_c = 0; V_{EB} = 0,5 \text{ V}$$

$$C_e < 17 \text{ pF}$$

Switching time

Turn-off time when switched from

$$I_{Con} = 15 \text{ mA}; I_{Bon} = 1 \text{ mA} \text{ to cut-off with } -I_{Boff} = 1 \text{ mA}$$

$$t_{off} < 1 \mu s$$

Test circuit for measuring turn-off time:

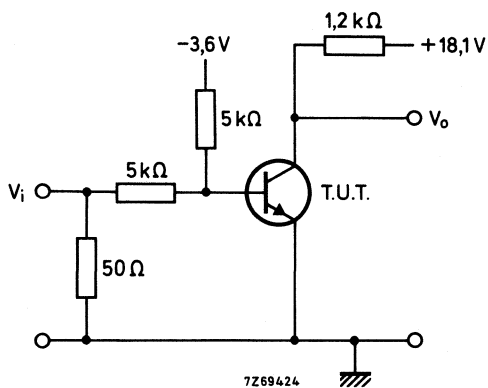

Pulse generator:

Input voltage  $V_i = +10 \text{ V}$

Pulse duration  $t_p = 1 \mu s$

Duty factor  $\delta = 0,01$

Source impedance  $Z_S = 50 \Omega$







## N-P-N DARLINGTON TRANSISTORS

Silicon planar transistors in TO-39 metal envelopes, intended for industrial switching applications e.g. print hammer, solenoid, relay and lamp driving.

P-N-P complements are the BSS60, BSS61 and BSS62.

### QUICK REFERENCE DATA

		BSS50	BSS51	BSS52	
Collector-base voltage (open emitter)	$V_{CBO}$ max.	60	80	90	V
Collector-emitter voltage (see Fig. 4)	$V_{CER}$ max.	45	60	80	V
Collector current (d.c.)	$I_C$ max.	1,0		A	
Total power dissipation up to $T_{amb} = 25\text{ }^\circ\text{C}$	$P_{tot}$ max.	0,8		W	
up to $T_{case} = 25\text{ }^\circ\text{C}$	$P_{tot}$ max.	5,0		W	
Collector-emitter saturation voltage $I_C = 1,0\text{ A}; I_B = 1,0\text{ mA}$	<b>BSS51</b> $V_{CEsat} <$	1,6		V	
$I_C = 1,0\text{ A}; I_B = 4,0\text{ mA}$	<b>BSS50; BSS52</b> $V_{CEsat} <$	1,6		V	
D.C. current gain $I_C = 500\text{ mA}; V_{CE} = 10\text{ V}$	$h_{FE} >$	2000			
Turn-off time when switched from $I_{Con} = 500\text{ mA}; I_{Bon} = 0,5\text{ mA}$ to cut-off with $-I_{Boff} = 0,5\text{ mA}$	$t_{off}$ typ.	1,5		$\mu\text{s}$	

### MECHANICAL DATA

Dimensions in mm

Fig. 1 TO-39.

Collector connected to case

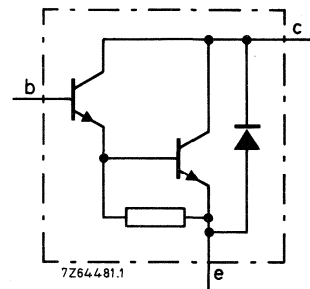
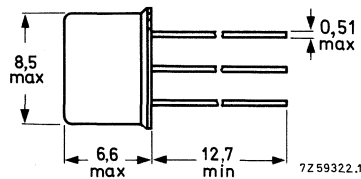
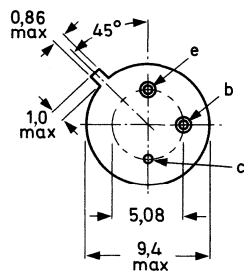

Maximum lead diameter is guaranteed only for 12,7 mm.

**RATINGS**

Limiting values in accordance with the Absolute Maximum System (IEC 134)

			BSS50	BSS51	BSS52	
Collector-base voltage (open emitter)	$V_{CBO}$	max.	60	80	90	V
Collector-emitter voltage (see Fig. 4)	$V_{CER}$	max.	45	60	80	V
Emitter-base voltage (open collector)	$V_{EBO}$	max.	5,0	5,0	5,0	V
Collector current (d.c.)	$I_C$	max.		1,0		A
Collector current (peak value)	$I_{CM}$	max.		2,0		A
Base current (d.c.)	$I_B$	max.		0,1		A
Total power dissipation up to $T_{amb} = 25\text{ }^\circ\text{C}$	$P_{tot}$	max.		0,8		W
up to $T_{case} = 25\text{ }^\circ\text{C}$	$P_{tot}$	max.		5,0		W
Storage temperature range	$T_{stg}$		-65 to + 150			$^\circ\text{C}$
Junction temperature *	$T_j$	max.		200		$^\circ\text{C}$

**THERMAL RESISTANCE \***

From junction to ambient in free air	$R_{th\ j-a}$	=		220		K/W
From junction to case	$R_{th\ j-c}$	=		35		K/W

\* Based on maximum average junction temperature in line with common industrial practice. The resulting higher junction temperature of the output transistor part is taken into account.

## CHARACTERISTICS

$T_j = 25\text{ }^\circ\text{C}$  unless otherwise specified

Collector cut-off current

$I_E = 0; V_{CB} = 45\text{ V}$

**BSS50**  $I_{CBO} < 50\text{ nA}$

$I_E = 0; V_{CB} = 60\text{ V}$

**BSS51**  $I_{CBO} < 50\text{ nA}$

$I_E = 0; V_{CB} = 80\text{ V}$

**BSS52**  $I_{CBO} < 50\text{ nA}$

Emitter cut-off current

$I_C = 0; V_{EB} = 4,0\text{ V}$

$I_{EBO} < 50\text{ nA}$

Base-emitter voltage

$I_C = 150\text{ mA}; V_{CE} = 10\text{ V}$

$V_{BE} 1,3\text{ to }1,65\text{ V}$

$I_C = 500\text{ mA}; V_{CE} = 10\text{ V}$

$V_{BE} 1,4\text{ to }1,75\text{ V}$

Saturation voltages

$I_C = 500\text{ mA}; I_B = 0,5\text{ mA}$

$V_{CEsat} < 1,3\text{ V}$

$V_{BEsat} < 1,9\text{ V}$

$I_C = 500\text{ mA}; I_B = 0,5\text{ mA}; T_j = 200\text{ }^\circ\text{C}$

$V_{CEsat} < 1,3\text{ V}$

$I_C = 1,0\text{ A}; I_B = 1,0\text{ mA}$

**BSS51**  $V_{CEsat} < 1,6\text{ V}$

$V_{BEsat} < 2,2\text{ V}$

$I_C = 1,0\text{ A}; I_B = 1,0\text{ mA}; T_j = 200\text{ }^\circ\text{C}$

**BSS51**  $V_{CEsat} < 2,3\text{ V}$

$I_C = 1,0\text{ A}; I_B = 4,0\text{ mA}$

**BSS50; BSS52**  $V_{CEsat} < 1,6\text{ V}$

$V_{BEsat} < 2,2\text{ V}$

$I_C = 1,0\text{ A}; I_B = 4,0\text{ mA}; T_j = 200\text{ }^\circ\text{C}$

**BSS50; BSS52**  $V_{CEsat} < 1,6\text{ V}$

D.C. current gain

$I_C = 150\text{ mA}; V_{CE} = 10\text{ V}$

$h_{FE} > 1000$

$I_C = 500\text{ mA}; V_{CE} = 10\text{ V}$

$h_{FE} > 2000$

Small-signal current gain at  $f = 35\text{ MHz}$

$I_C = 500\text{ mA}; V_{CE} = 5\text{ V}$

$h_{fe} \text{ typ. } 10$

**Switching times** (see Figs 2 and 3)

$I_{Con} = 500 \text{ mA}$ ;  $I_{Bon} = -I_{Boff} = 0,5 \text{ mA}$

Turn-on time

$t_{on}$  typ.  $0,4 \mu\text{s}$

Turn-off time

$t_{off}$  typ.  $1,5 \mu\text{s}$

$I_{Con} = 1,0 \text{ A}$ ;  $I_{Bon} = -I_{Boff} = 1,0 \text{ mA}$

Turn-on time

$t_{on}$  typ.  $0,4 \mu\text{s}$

Turn-off time

$t_{off}$  typ.  $1,5 \mu\text{s}$

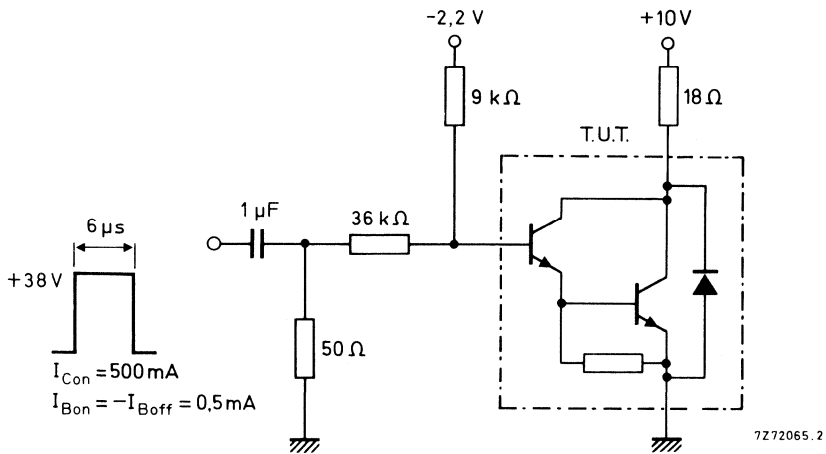

Fig. 2 Test circuit for 500 mA switching.

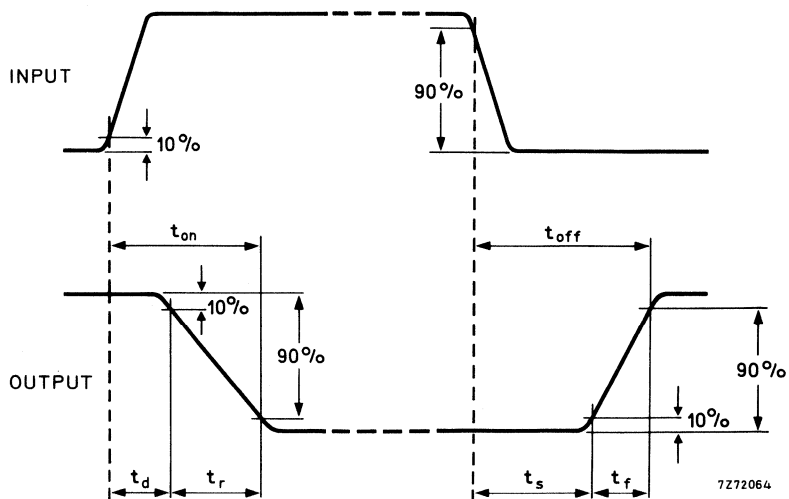

Fig. 3 Switching waveforms.

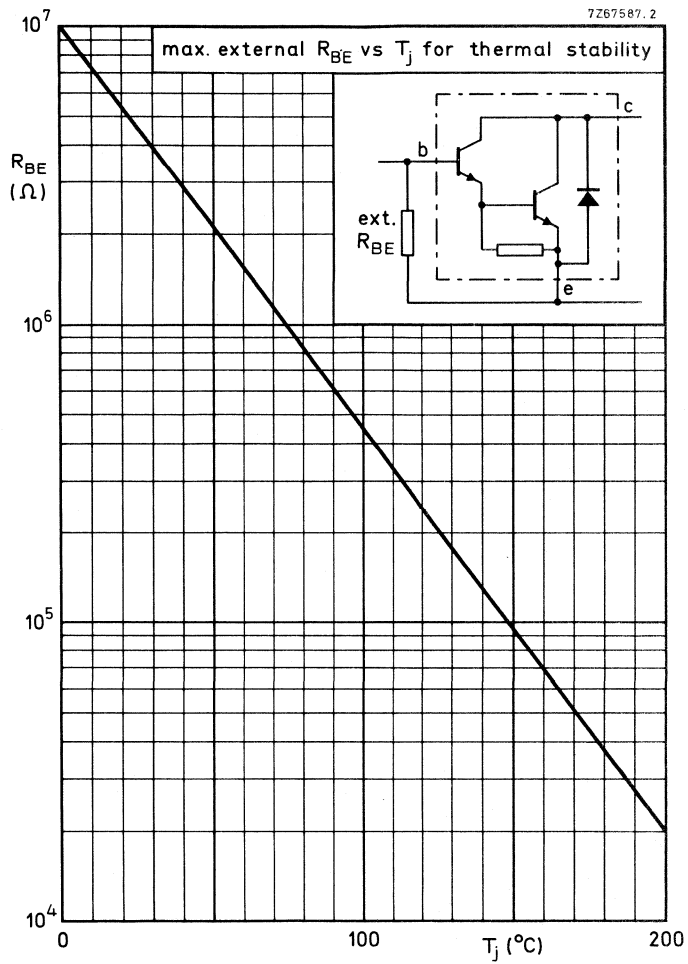

Fig. 4.

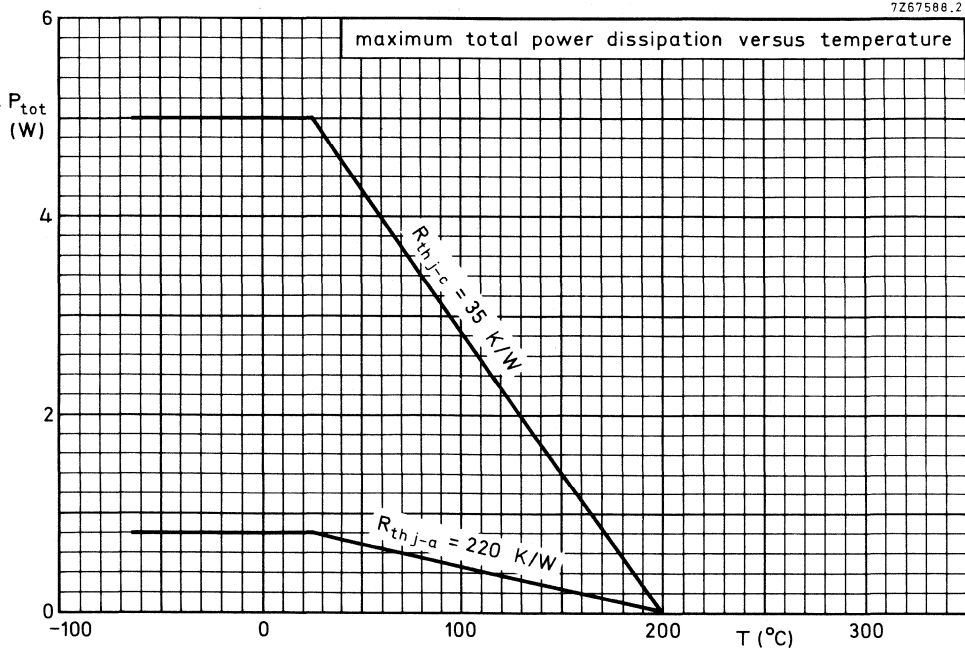

Fig. 5.

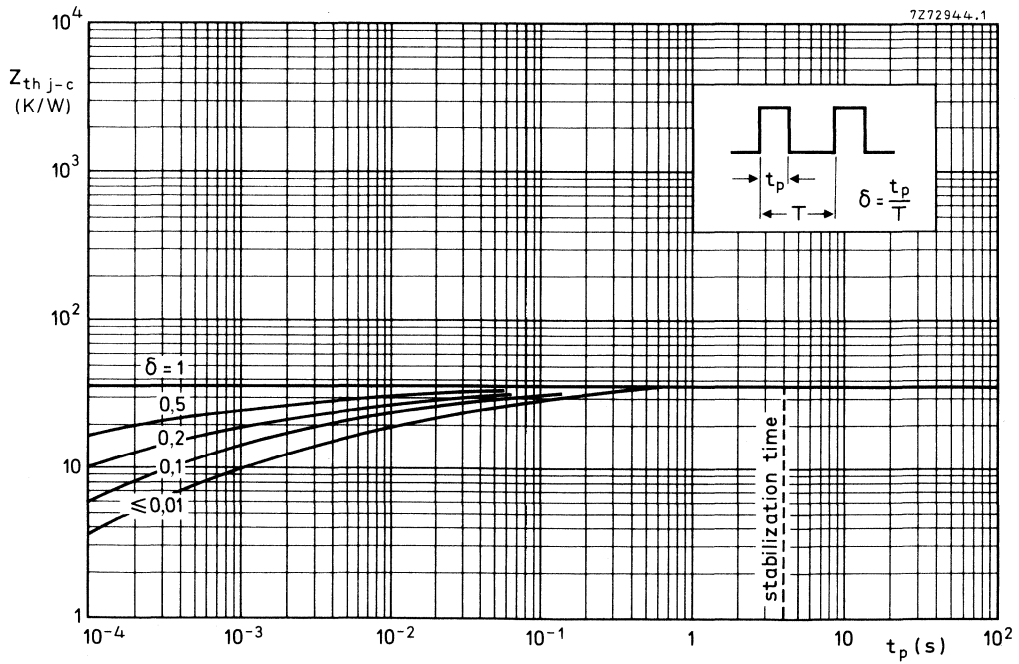

Fig. 6.

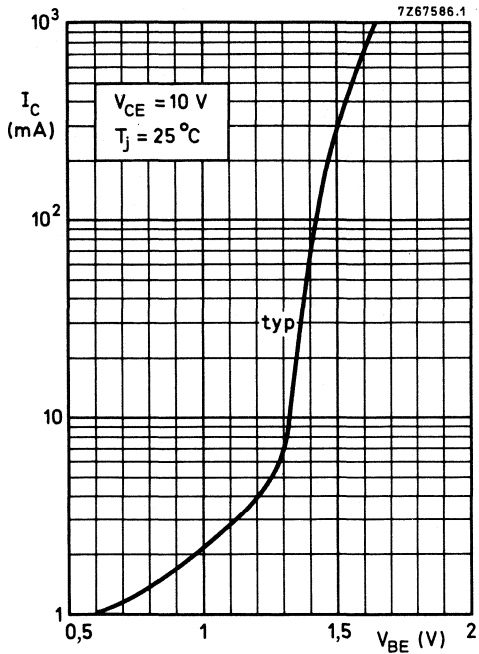

Fig. 7.

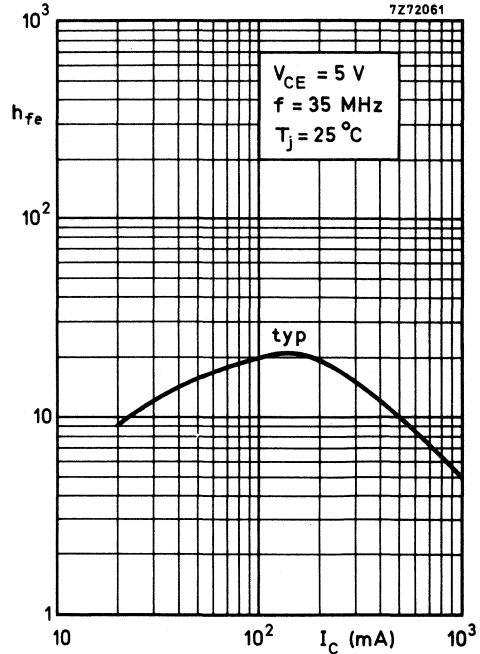

Fig. 8.

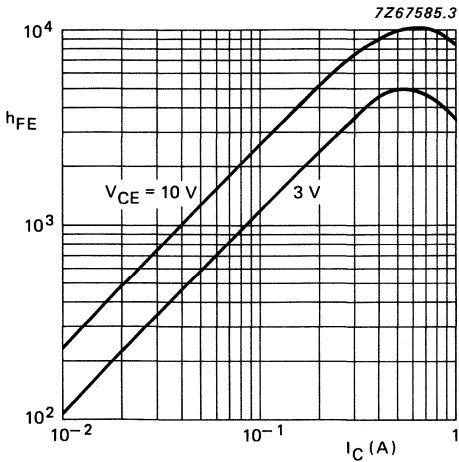

Fig. 9  $T_j = 25\text{ }^\circ\text{C}$ ; typical values.

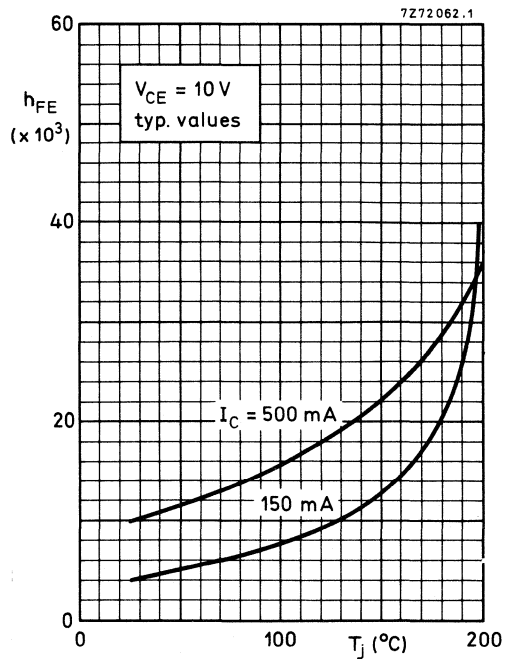

Fig. 10.

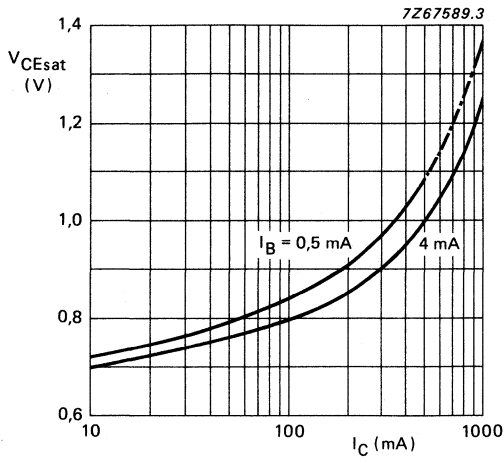

Fig. 11  $T_j = 25 \text{ }^\circ\text{C}$ ; typical values.

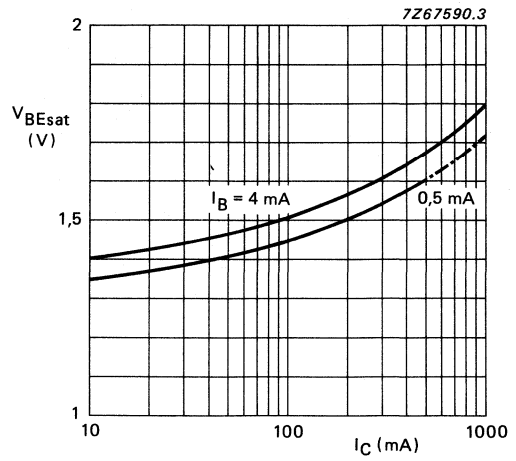

Fig. 12  $T_j = 25 \text{ }^\circ\text{C}$ ; typical values.



## P-N-P DARLINGTON TRANSISTORS



Silicon planar transistors in TO-39 metal envelopes, intended for industrial switching applications e.g. print hammer, solenoid, relay and lamp driving.

N-P-N complements are the BSS50, BSS51 and BSS52.

## QUICK REFERENCE DATA

		BSS60	BSS61	BSS62	
Collector-base voltage (open emitter)	$-V_{CBO}$	max. 60	80	90	V
Collector-emitter voltage (see Fig. 4)	$-V_{CER}$	max. 45	60	80	V
Collector current (d.c.)	$-I_C$		1,0		A
Total power dissipation up to $T_{amb} = 25\text{ }^\circ\text{C}$	$P_{tot}$	max.	0,8		W
up to $T_{case} = 25\text{ }^\circ\text{C}$	$P_{tot}$	max.	5,0		W
Collector-emitter saturation voltage $-I_C = 1,0\text{ A}; -I_B = 1,0\text{ mA}$	<b>BSS61</b> $-V_{CEsat}$	<	1,6		V
$-I_C = 1,0\text{ A}; -I_B = 4,0\text{ mA}$	<b>BSS60; BSS62</b> $-V_{CEsat}$	<	1,6		V
D.C. current gain $-I_C = 500\text{ mA}; -V_{CE} = 10\text{ V}$	$h_{FE}$	>	2000		
Turn-off time when switched from $-I_{Con} = 500\text{ mA}; -I_{Bon} = 0,5\text{ mA}$ to cut-off with $-I_{Boff} = 0,5\text{ mA}$	$t_{off}$	typ.	1,5		$\mu\text{s}$

## MECHANICAL DATA

Dimensions in mm

Fig. 1 TO-39.

Collector connected to case

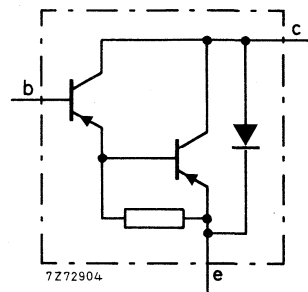
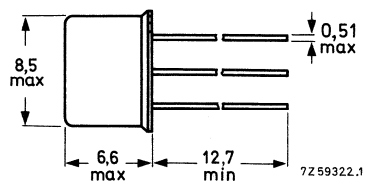
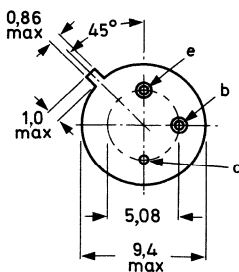

Maximum lead diameter is guaranteed only for 12,7 mm

**RATINGS**

Limiting values in accordance with the Absolute Maximum System (IEC 134)

			BSS60	BSS61	BSS62	
Collector-base voltage (open emitter)	$-V_{CBO}$	max.	60	80	90	V
Collector-emitter voltage (see Fig. 4)	$-V_{CER}$	max.	45	60	80	V
Emitter-base voltage (open collector)	$-V_{EBO}$	max.	5,0	5,0	5,0	V
Collector current (d.c.)	$-I_C$	max.		1,0		A
Collector current (peak value)	$-I_{CM}$	max.		2,0		A
Base current (d.c.)	$-I_B$	max.		0,1		A
Total power dissipation up to $T_{amb} = 25\text{ }^\circ\text{C}$	$P_{tot}$	max.		0,8		W
up to $T_{case} = 25\text{ }^\circ\text{C}$	$P_{tot}$	max.		5,0		W
Storage temperature range	$T_{stg}$		-65 to +150			$^\circ\text{C}$
Junction temperature *	$T_j$	max.	200			$^\circ\text{C}$
<b>THERMAL RESISTANCE *</b>						
From junction to ambient in free air	$R_{th\ j-a}$	=	220			K/W
From junction to case	$R_{th\ j-c}$	=	35			K/W

\* Based on maximum average junction temperature in line with common industrial practice. The resulting higher junction temperature of the output transistor part is taken into account.

## CHARACTERISTICS

$T_j = 25\text{ }^\circ\text{C}$  unless otherwise specified

Collector cut-off current

$$I_E = 0; -V_{CB} = 45\text{ V}$$

$$\text{BSS60} \quad -I_{CBO} < 50\text{ nA}$$

$$I_E = 0; -V_{CB} = 60\text{ V}$$

$$\text{BSS61} \quad -I_{CBO} < 50\text{ nA}$$

$$I_E = 0; -V_{CB} = 80\text{ V}$$

$$\text{BSS62} \quad -I_{CBO} < 50\text{ nA}$$

Emitter cut-off current

$$I_C = 0; -V_{EB} = 4,0\text{ V}$$

$$-I_{EBO} < 100\text{ nA}$$

Saturation voltages

$$-I_C = 500\text{ mA}; -I_B = 0,5\text{ mA}$$

$$-V_{CEsat} < 1,3\text{ V}$$

$$-V_{BEsat} < 1,9\text{ V}$$

$$-I_C = 500\text{ mA}; -I_B = 0,5\text{ mA}; T_j = 200\text{ }^\circ\text{C}$$

$$-V_{CEsat} < 1,3\text{ V}$$

$$-I_C = 1,0\text{ A}; -I_B = 1,0\text{ mA}$$

$$\text{BSS61} \quad -V_{CEsat} < 1,6\text{ V}$$

$$-V_{BEsat} < 2,2\text{ V}$$

$$-I_C = 1,0\text{ A}; -I_B = 1,0\text{ mA}; T_j = 200\text{ }^\circ\text{C}$$

$$\text{BSS61} \quad -V_{CEsat} < 1,6\text{ V}$$

$$-I_C = 1,0\text{ A}; -I_B = 4,0\text{ mA}$$

$$\text{BSS60; BSS62} \quad -V_{CEsat} < 1,6\text{ V}$$

$$-V_{BEsat} < 2,2\text{ V}$$

$$-I_C = 1,0\text{ A}; -I_B = 4,0\text{ mA}; T_j = 200\text{ }^\circ\text{C}$$

$$\text{BSS60; BSS62} \quad -V_{CEsat} < 1,6\text{ V}$$

D.C. current gain

$$-I_C = 150\text{ mA}; -V_{CE} = 10\text{ V}$$

$$h_{FE} > 1000$$

$$-I_C = 500\text{ mA}; -V_{CE} = 10\text{ V}$$

$$h_{FE} > 2000$$

Small-signal current gain at  $f = 35\text{ MHz}$

$$-I_C = 500\text{ mA}; -V_{CE} = 5\text{ V}$$

$$h_{fe} \text{ typ. } 10$$

Switching times (see Figs 2 and 3)

$-I_{Con} = 500 \text{ mA}; -I_{Bon} = I_{Boff} = 0,5 \text{ mA}$

Turn-on time

$t_{on}$  typ.  $0,4 \mu\text{s}$

Turn-off time

$t_{off}$  typ.  $1,5 \mu\text{s}$

$-I_{Con} = 1,0 \text{ A}; -I_{Bon} = I_{Boff} = 1,0 \text{ mA}$

Turn-on time

$t_{on}$  typ.  $0,4 \mu\text{s}$

Turn-off time

$t_{off}$  typ.  $1,5 \mu\text{s}$

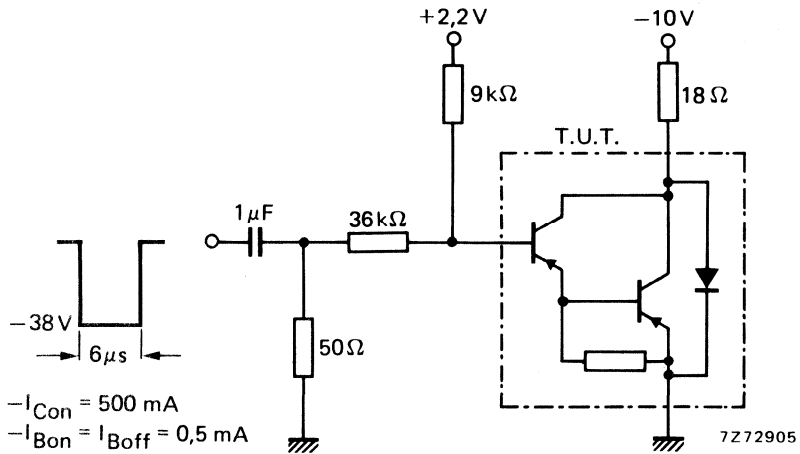

Fig. 2 Test circuit for 500 mA switching.

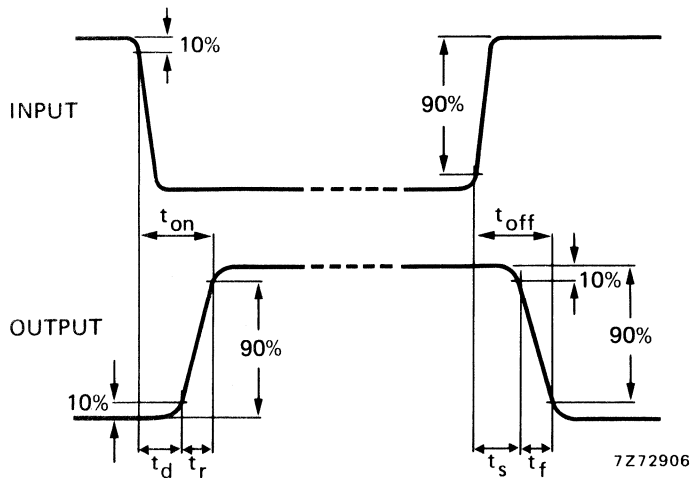

Fig. 3 Switching waveforms.

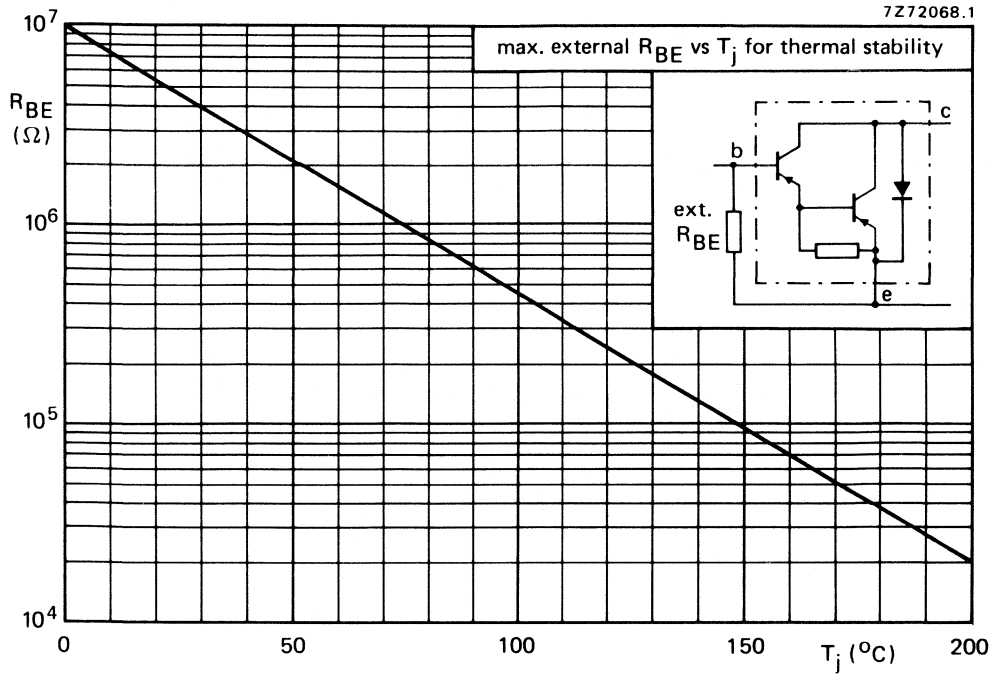

Fig. 4.

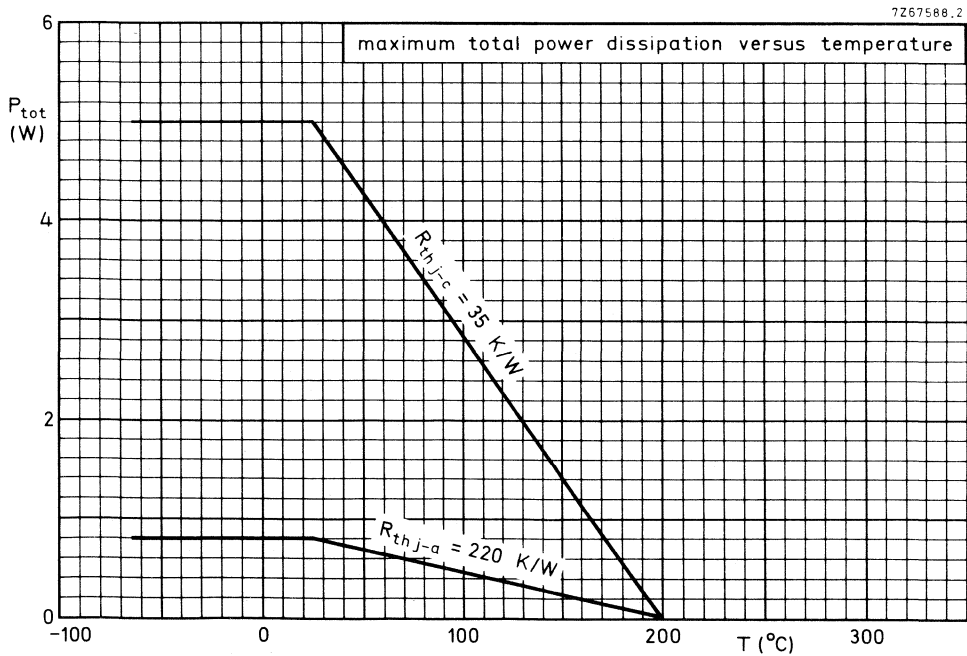

Fig. 5.

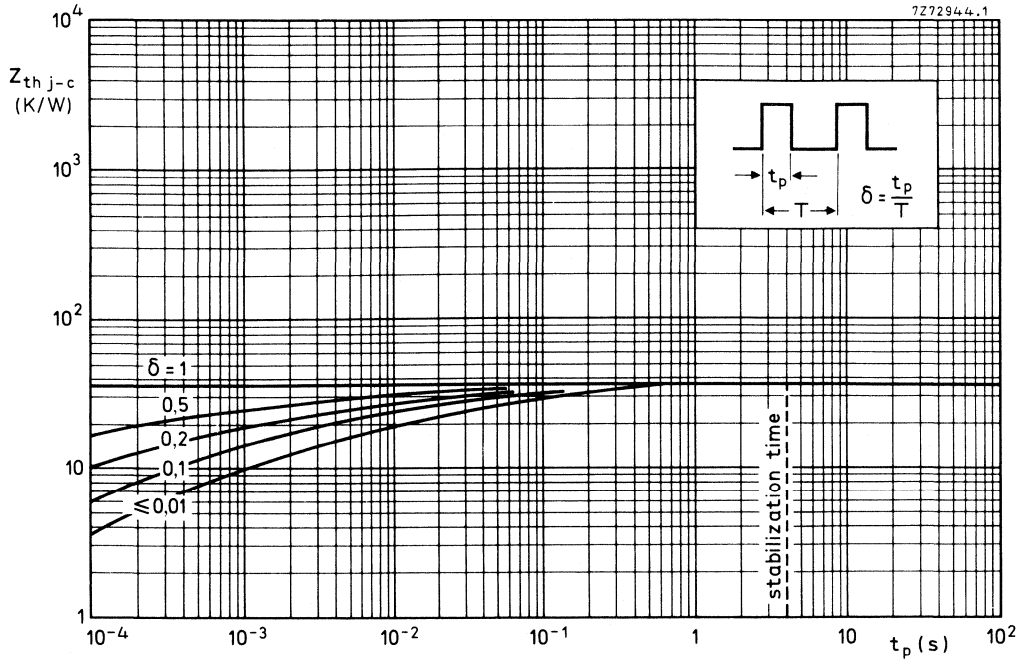

Fig. 6 Thermal impedance as a function of pulse duration.

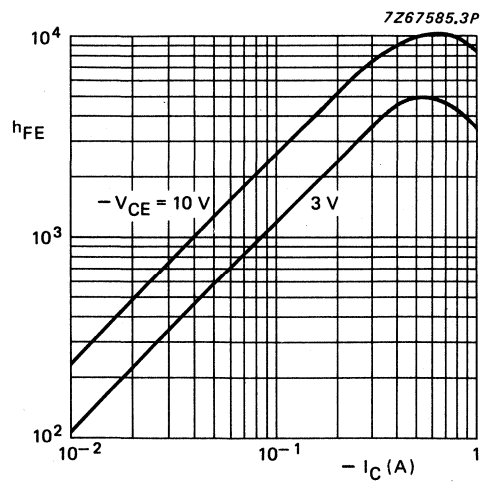

Fig. 7  $T_j = 25^\circ\text{C}$ ; typical values

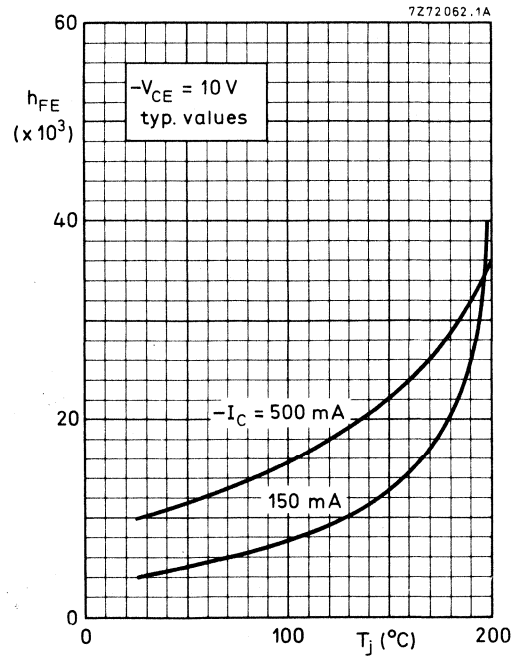

Fig. 8.

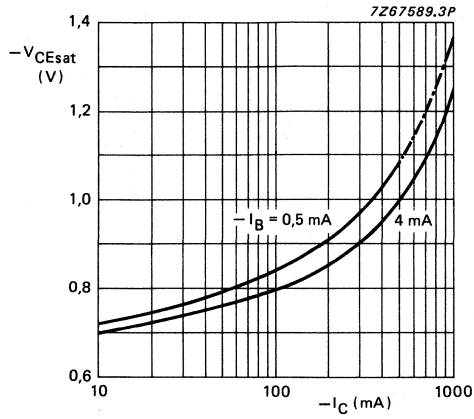

Fig. 9.

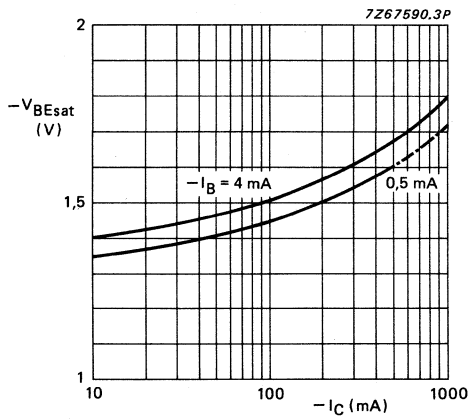

Fig. 10.

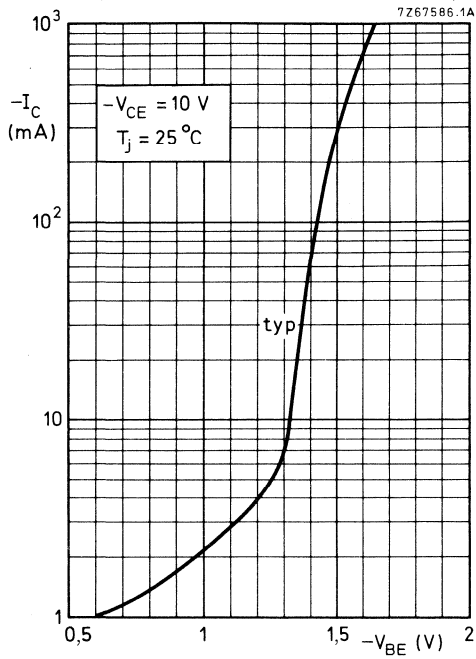

Fig. 11.

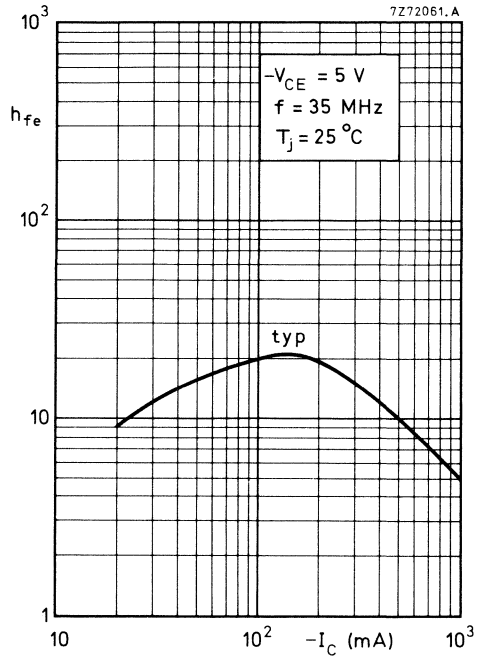

Fig. 12.





## HIGH-VOLTAGE P-N-P TRANSISTOR

Silicon planar epitaxial transistor in a plastic TO-92 envelope. It is intended for anode switching in dynamically driven numerical indicator tubes and as general purpose switching device.

### QUICK REFERENCE DATA

Collector-emitter voltage ( $R_{BE} = 10 \text{ k}\Omega$ )	$-V_{CER}$ max.	110 V
Collector-emitter voltage (open base)	$-V_{CEO}$ max.	100 V
Collector current (d.c.)	$-I_C$ max.	100 mA
Total power dissipation up to $T_{amb} = 25 \text{ }^\circ\text{C}$	$P_{tot}$ max.	500 mW
Junction temperature	$T_j$ max.	150 $^\circ\text{C}$
D.C. current gain at $T_j = 25 \text{ }^\circ\text{C}$ $-I_C = 25 \text{ mA}; -V_{CE} = 5 \text{ V}$	$h_{FE}$	> 30
Transition frequency at $f = 35 \text{ MHz}$ $-I_C = 25 \text{ mA}; -V_{CE} = 5 \text{ V}$	$f_T$	> 50 MHz

### MECHANICAL DATA

Dimensions in mm

Fig. 1 TO-92.

#### Pinning

- 1 = emitter
- 2 = base
- 3 = collector

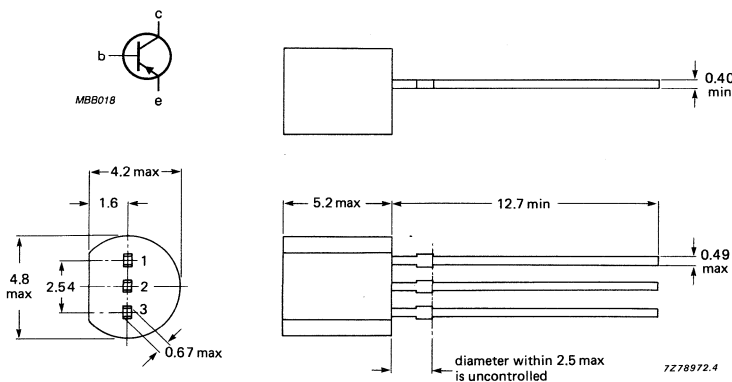

**RATINGS**

Limiting values in accordance with the Absolute Maximum System (IEC 134)

Collector-base voltage (open emitter)	$-V_{CB0}$	max.	110 V
Collector-emitter voltage ( $R_{BE} = 10\text{ k}\Omega$ )	$-V_{CER}$	max.	110 V
Collector-emitter voltage (open base)	$-V_{CEO}$	max.	100 V
Emitter-base voltage (open collector)	$-V_{EBO}$	max.	6 V
Collector current (d.c.)	$-I_C$	max.	100 mA
Total power dissipation up to $T_{amb} = 25\text{ }^\circ\text{C}$	$P_{tot}$	max.	500 mW
Storage temperature	$T_{stg}$		$-65$ to $+150\text{ }^\circ\text{C}$
Junction temperature	$T_j$	max.	150 $^\circ\text{C}$

**THERMAL RESISTANCE**

From junction to ambient in free air	$R_{th\ j-a}$	=	0,25 K/mW
--------------------------------------	---------------	---	-----------

**CHARACTERISTICS**

$T_j = 25\text{ }^\circ\text{C}$  unless otherwise specified

Collector cut-off current $I_E = 0; -V_{CB} = 100\text{ V}; T_j = 70\text{ }^\circ\text{C}$	$-I_{CBO}$	<	10 $\mu\text{A}$
Saturation voltages $-I_C = 25\text{ mA}; -I_B = 2,5\text{ mA}$	$-V_{CEsat}$	<	250 mV
	$-V_{BEsat}$	<	900 mV
D.C. current gain $-I_C = 10\text{ mA}; -V_{CE} = 5\text{ V}$ $-I_C = 25\text{ mA}; -V_{CE} = 5\text{ V}$	$h_{FE}$	>	30
	$h_{FE}$	>	30
Collector capacitance at $f = 1\text{ MHz}$ $I_E = I_e = 0; -V_{CB} = 10\text{ V}$	$C_c$	<	5 pF
Transition frequency at $f = 35\text{ MHz}$ $-I_C = 25\text{ mA}; -V_{CE} = 5\text{ V}$	$f_T$	>	50 MHz

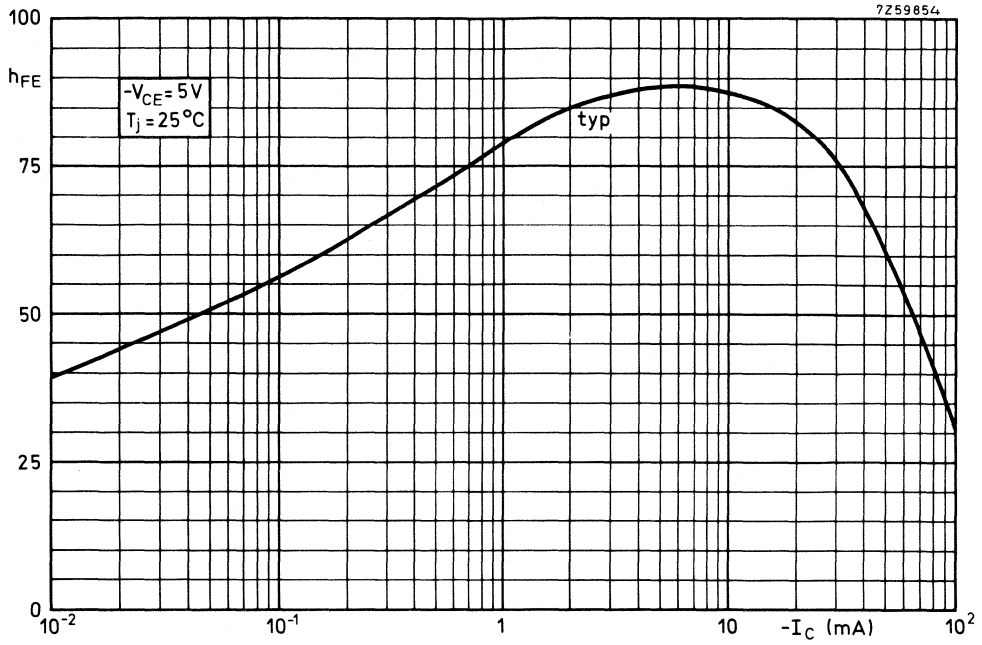

Fig. 2.

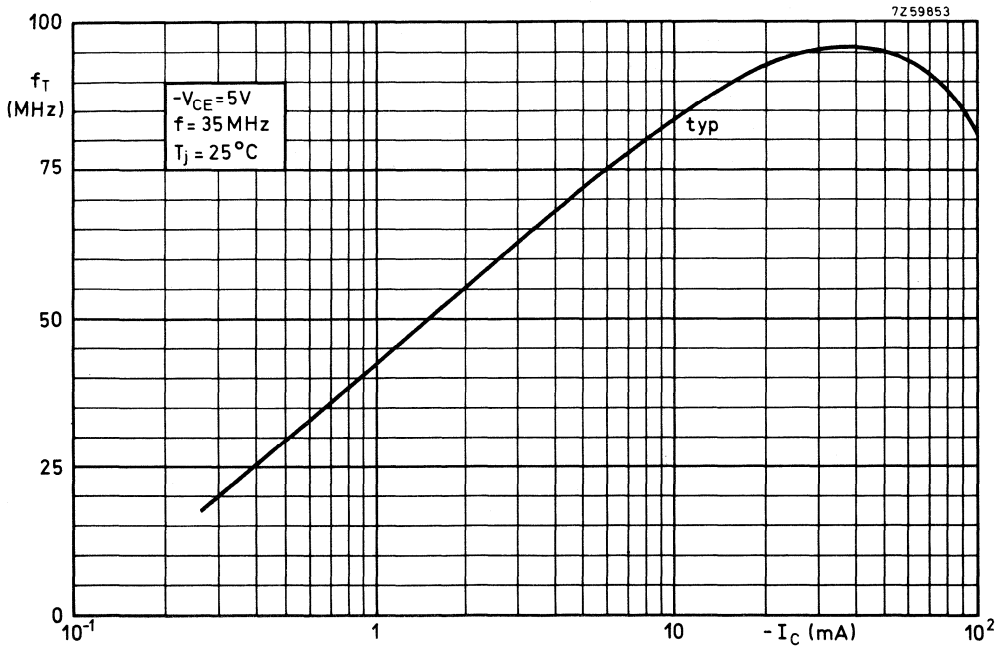

Fig. 3.

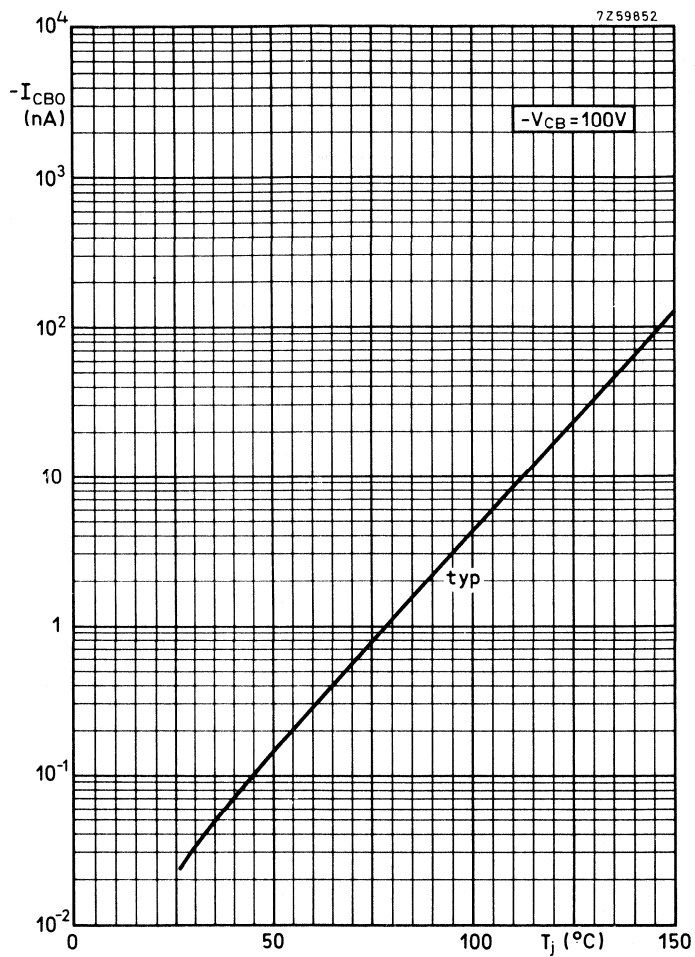

Fig. 4.

## SILICON PLANAR EPITAXIAL TRANSISTORS



P-N-P transistors in TO-39 metal envelopes with the collector connected to the case. These transistors are intended for general industrial applications.

## QUICK REFERENCE DATA

		BSV15	BSV16	BSV17	
Collector-emitter voltage (open base)	$-V_{CEO}$ max.	40	60	80	V
Collector current (d.c.)	$-I_C$ max.	1,0			A
Total power dissipation up to $T_{amb} = 25\text{ }^\circ\text{C}$ up to $T_{case} = 25\text{ }^\circ\text{C}$	$P_{tot}$ max.	0,8			W
	$P_{tot}$ max.	5,0			W
Junction temperature	$T_j$ max.	200			$^\circ\text{C}$
Transition frequency at $f = 20\text{ MHz}$ $-I_C = 50\text{ mA}; -V_{CE} = 10\text{ V}$	$f_T$ >	50			MHz
		BSV15-10   BSV15-16 BSV16-10   BSV16-16 BSV17-10			
D.C. current gain $-I_C = 100\text{ mA}; -V_{CE} = 1\text{ V}$	$h_{FE}$	63-160   100-250			

## MECHANICAL DATA

Dimensions in mm

Fig. 1 TO-39.

Collector connected to case

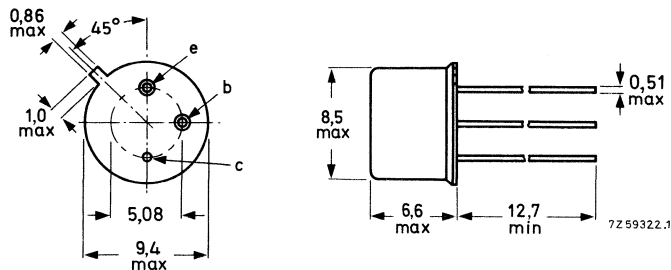

Maximum lead diameter is guaranteed only for 12,7 mm.

**RATINGS**

Limiting values in accordance with the Absolute Maximum System (IEC 134)

			<b>BSV15</b>	<b>BSV16</b>	<b>BSV17</b>	
Collector-emitter voltage (open base)	$-V_{CE0}$	max.	40	60	80	V
Collector-emitter voltage ( $V_{BE} = 0$ )	$-V_{CES}$	max.	40	60	90	V
Emitter-base voltage (open collector)	$-V_{EBO}$	max.	5	5	5	V
Collector current (d.c.)	$-I_C$	max.		1,0		A
Base current (d.c.)	$-I_B$	max.		200		mA
Total power dissipation						
up to $T_{amb} = 25\text{ }^{\circ}\text{C}$	$P_{tot}$	max.		0,8		W
up to $T_{case} = 25\text{ }^{\circ}\text{C}$	$P_{tot}$	max.		5,0		W
up to $T_{mb} = 50\text{ }^{\circ}\text{C}$	$P_{tot}$	max.		5,0		W
Storage temperature range	$T_{stg}$			-65 to +150		$^{\circ}\text{C}$
Junction temperature	$T_j$	max.		200		$^{\circ}\text{C}$

**THERMAL RESISTANCE**

From junction to ambient in free air	$R_{th\ j-a}$	=		220		K/W
From junction to case	$R_{th\ j-c}$	=		35		K/W
From junction to mounting base	$R_{th\ j-mb}$	=		30		K/W

## CHARACTERISTICS

$T_{amb} = 25\text{ }^{\circ}\text{C}$  unless otherwise specified

			BSV15	BSV16	BSV17
Collector cut-off currents					
$V_{BE} = 0; -V_{CE} = 40\text{ V}$	$-I_{CES}$	<	100	—	— nA
$V_{BE} = 0; -V_{CE} = 40\text{ V}; T_{amb} = 150\text{ }^{\circ}\text{C}$	$-I_{CES}$	<	50	—	— $\mu\text{A}$
$V_{BE} = 0; -V_{CE} = 60\text{ V}$	$-I_{CES}$	<	—	100	— nA
$V_{BE} = 0; -V_{CE} = 60\text{ V}; T_{amb} = 150\text{ }^{\circ}\text{C}$	$-I_{CES}$	<	—	50	— $\mu\text{A}$
$V_{BE} = 0; -V_{CE} = 80\text{ V}$	$-I_{CES}$	<	—	—	100 nA
$V_{BE} = 0; -V_{CE} = 80\text{ V}; T_{amb} = 150\text{ }^{\circ}\text{C}$	$-I_{CES}$	<	—	—	50 $\mu\text{A}$
$-V_{BE} = 0,2\text{ V}; -V_{CE} = 40\text{ V}; T_{amb} = 100\text{ }^{\circ}\text{C}$	$-I_{CEX}$	<	50	—	— $\mu\text{A}$
$-V_{BE} = 0,2\text{ V}; -V_{CE} = 60\text{ V}; T_{amb} = 100\text{ }^{\circ}\text{C}$	$-I_{CEX}$	<	—	50	— $\mu\text{A}$
$-V_{BE} = 0,2\text{ V}; -V_{CE} = 80\text{ V}; T_{amb} = 100\text{ }^{\circ}\text{C}$	$-I_{CEX}$	<	—	—	50 $\mu\text{A}$
Emitter cut-off current					
$I_C = 0; -V_{EB} = 4\text{ V}$	$-I_{EBO}$	<	50	50	50 nA
Breakdown voltages					
$I_B = 0; -I_C = 50\text{ mA}; t_p = 200\text{ }\mu\text{s}; \delta = 0,01$	$-V_{(BR)CEO}$	>	40	60	80 V
$V_{BE} = 0; -I_C = 10\text{ }\mu\text{A}$	$-V_{(BR)CES}$	>	40	60	90 V
$I_C = 0; -I_E = 10\text{ }\mu\text{A}$	$-V_{(BR)EBO}$	>	5	5	5 V
Base-emitter voltage					
$-I_C = 100\text{ mA}; -V_{CE} = 1\text{ V}$	$-V_{BE}$	<		1,0	V
$-I_C = 500\text{ mA}; -V_{CE} = 1\text{ V}$	$-V_{BE}$	typ.		0,85	V
				0,7 to 1,4	V
Saturation voltage					
$-I_C = 500\text{ mA}; -I_B = 25\text{ mA}$	$-V_{CEsat}$	<		1,0	V
Collector capacitance at $f = 1\text{ MHz}$					
$I_E = I_e = 0; -V_{CB} = 10\text{ V}$	$C_c$	typ.		20	pF
		<		30	pF
$I_E = I_e = 0; -V_{CB} = 10\text{ V}$	$C_c$	typ.		15	pF
		<		25	pF
Emitter capacitance at $f = 1\text{ MHz}$					
$I_C = I_c = 0; -V_{EB} = 0,5\text{ V}$	$C_e$	typ.		180	pF
Transition frequency at $f = 20\text{ MHz}$					
$-I_C = 50\text{ mA}; -V_{CE} = 10\text{ V}$	$f_T$	>		50	MHz

CHARACTERISTICS (continued)

			BSV15-10 BSV16-10 BSV17-10	BSV15-16 BSV16-16
D.C. current gain				
$-I_C = 0,1 \text{ mA}; -V_{CE} = 1 \text{ V}$	$h_{FE}$	> typ.	20 75	30 120
$-I_C = 100 \text{ mA}; -V_{CE} = 1 \text{ V}$	$h_{FE}$	typ.	100 63 to 160	160 100 to 250
$-I_C = 500 \text{ mA}; -V_{CE} = 1 \text{ V}$	$h_{FE}$	> typ.	25 55	35 85
h-parameter at $f = 1 \text{ kHz}$				
$-I_C = 1 \text{ mA}; -V_{CE} = 5 \text{ V}$				
Small signal current gain	$h_{fe}$	>	20	
Switching times				
Turn-on time				
$-I_C = 100 \text{ mA}; -I_B = +I_{BM} = 5 \text{ mA}$	$t_{on}$	<	500	ns
Turn-off time				
$-I_C = 100 \text{ mA}; -I_B = +I_{BM} = 5 \text{ mA}$				
Storage time	$t_s$	<	500	ns
Fall time	$t_f$	<	150	ns

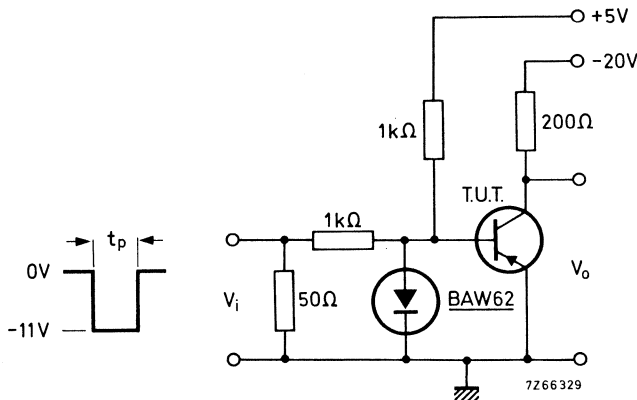

Fig. 2 Test circuit.

Pulse generator:

Pulse duration	$t_p \geq 10 \mu\text{s}$
Rise time	$t_r \leq 15 \text{ ns}$
Fall time	$t_f \leq 15 \text{ ns}$
Source impedance	$R_S = 50 \Omega$

Oscilloscope:

Rise time	$\leq 15 \text{ ns}$
Input impedance	$\geq 100 \text{ k}\Omega$



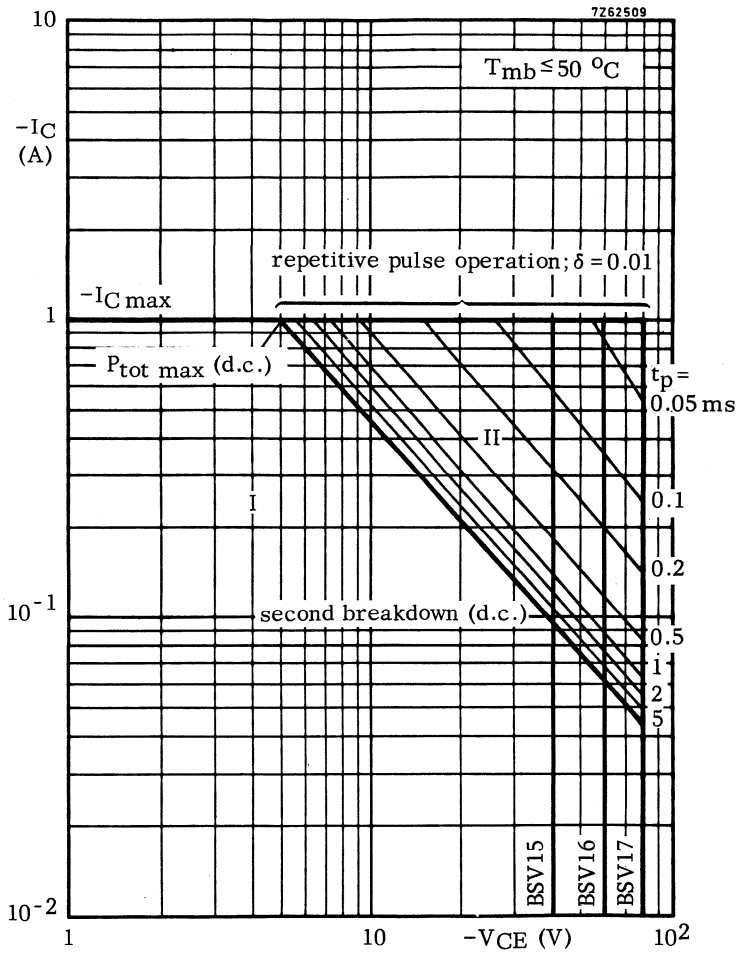
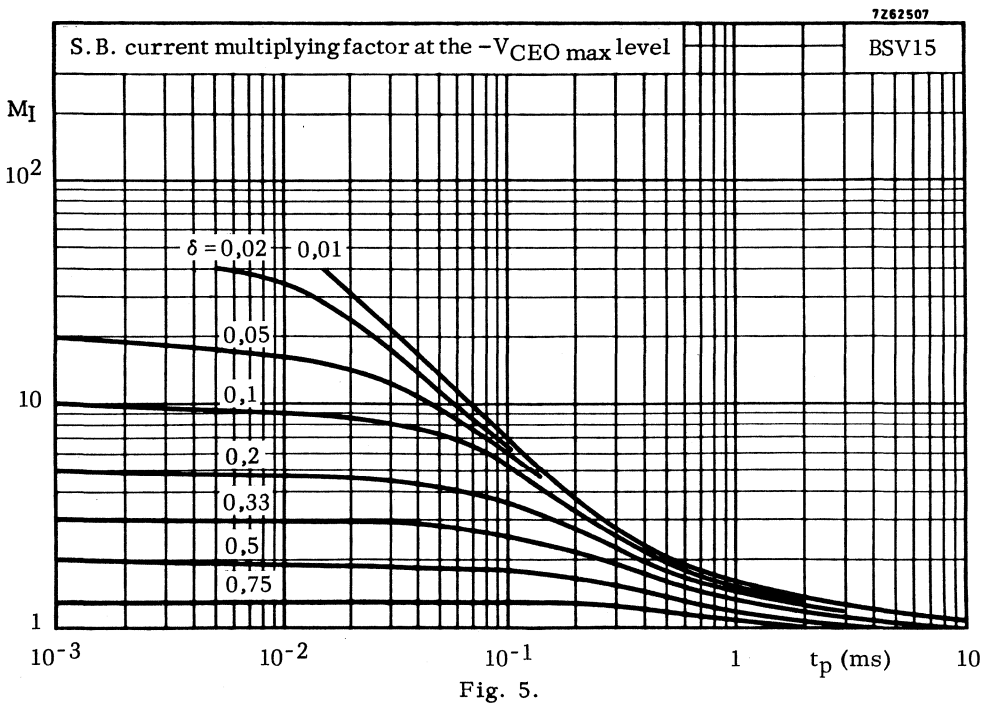
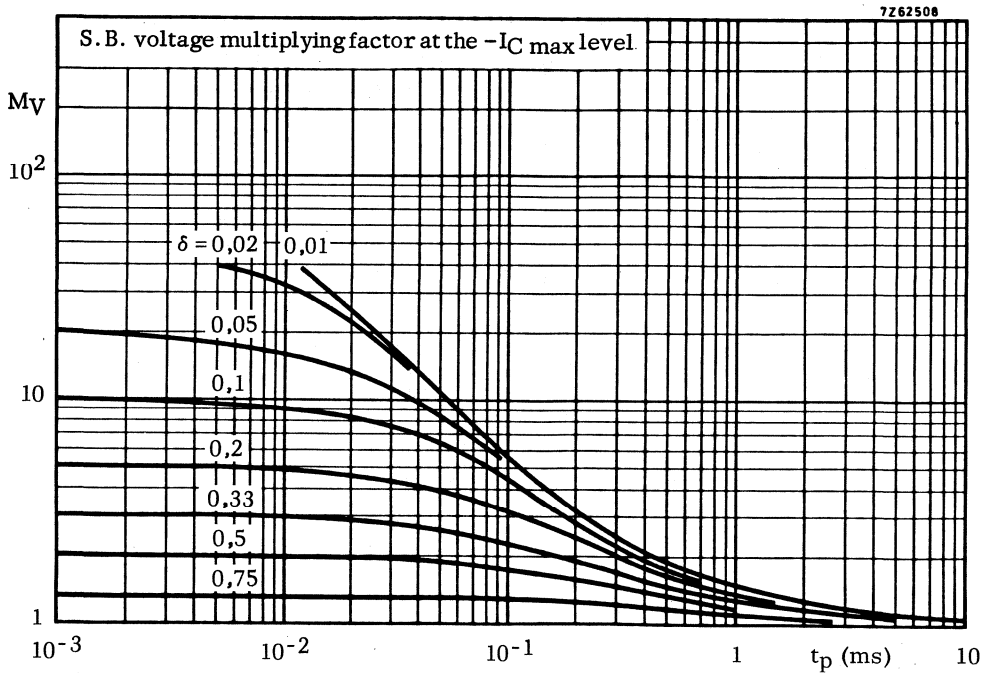

Fig. 3.

Safe Operating Area with the transistor forward biased

- I Region of permissible d.c. operation
- II Permissible extension for repetitive pulse operation.



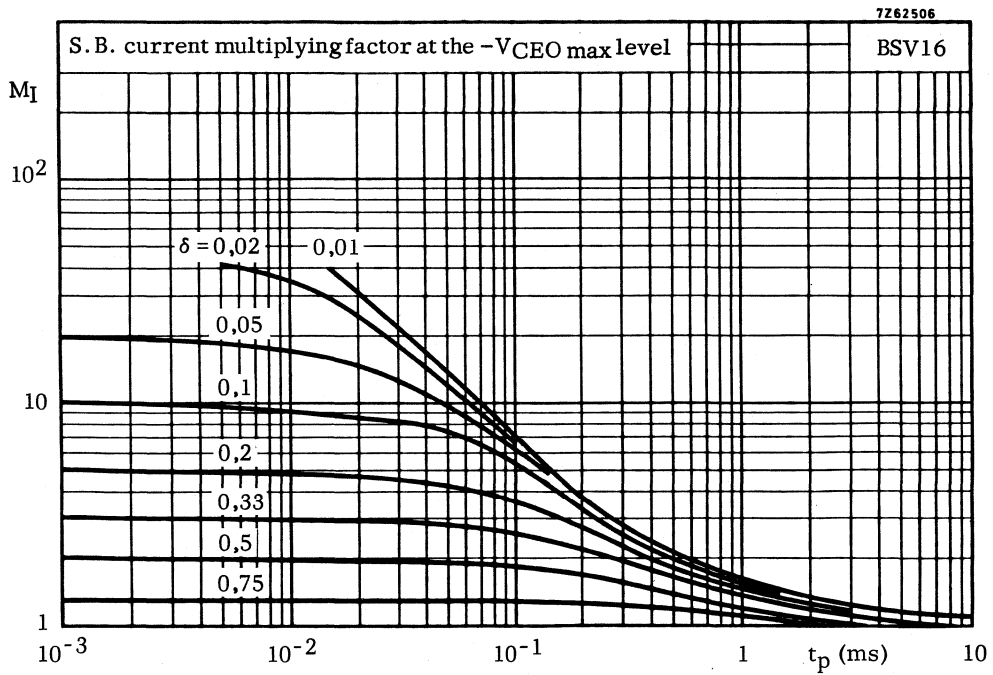

Fig. 6.

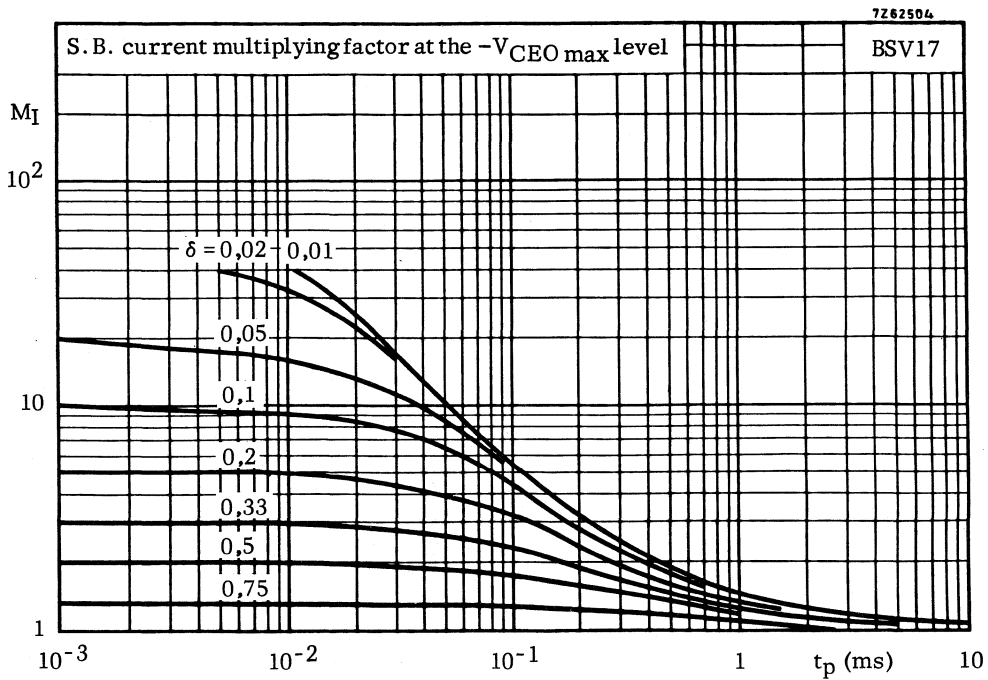

Fig. 7.

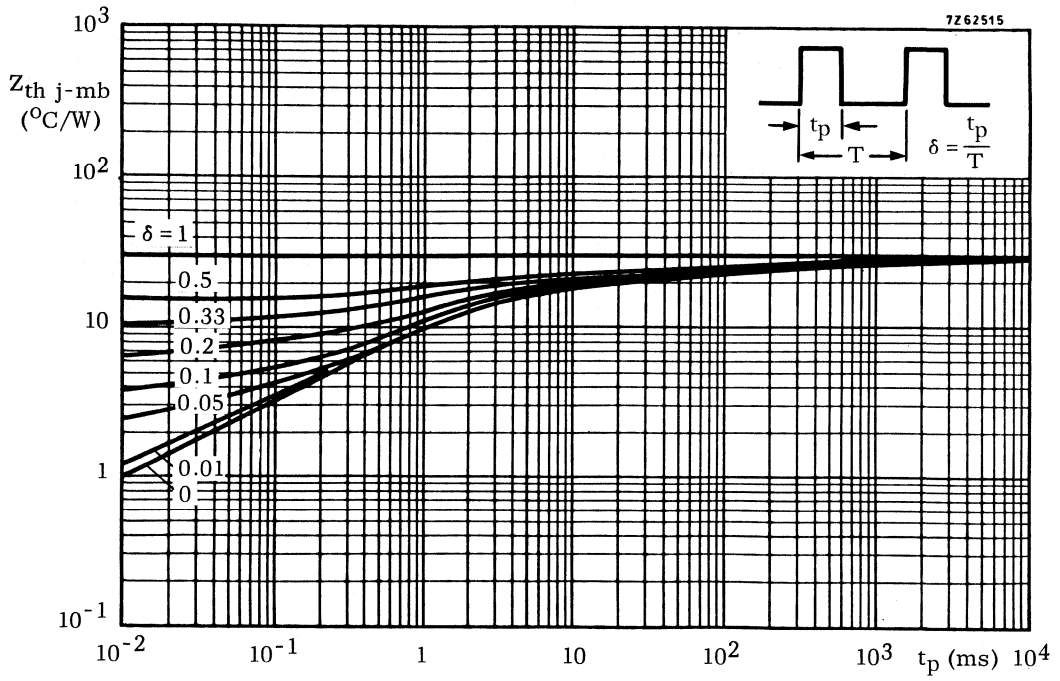

Fig. 8.

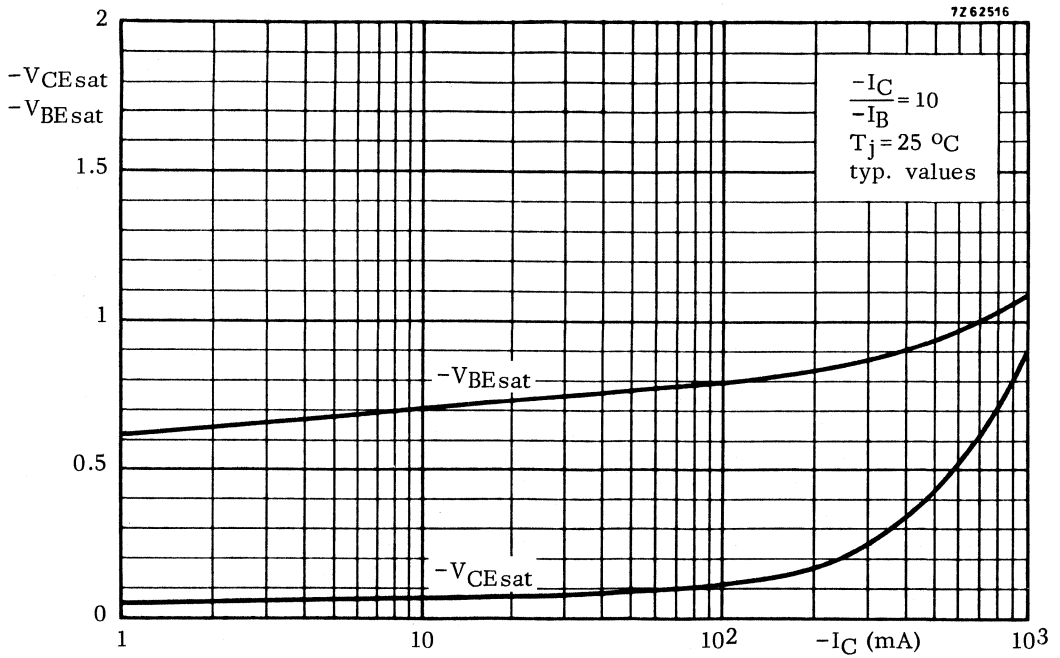

Fig. 9.

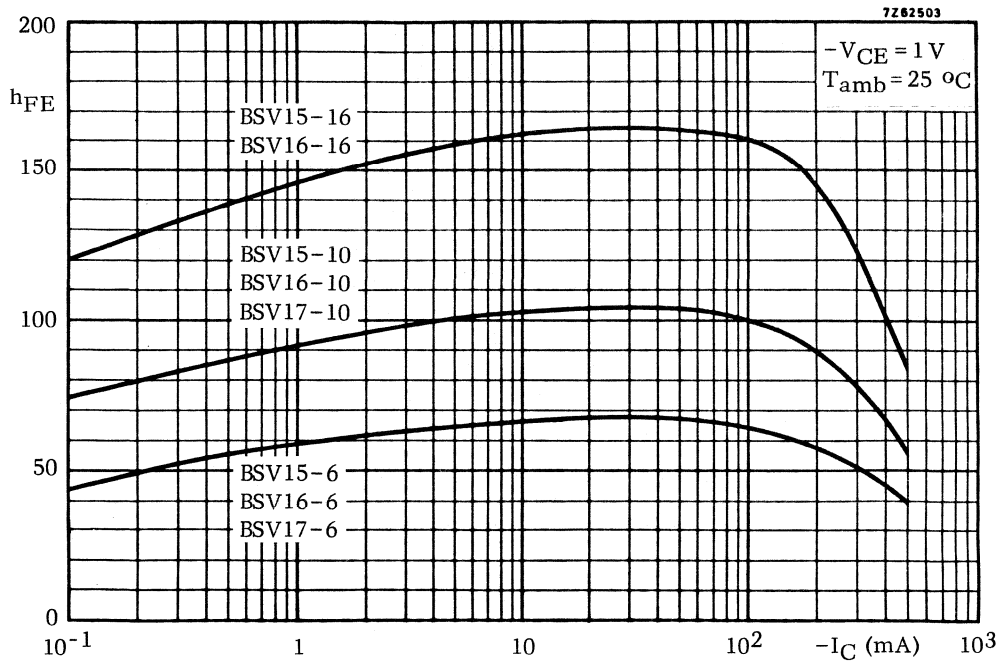

Fig. 10.

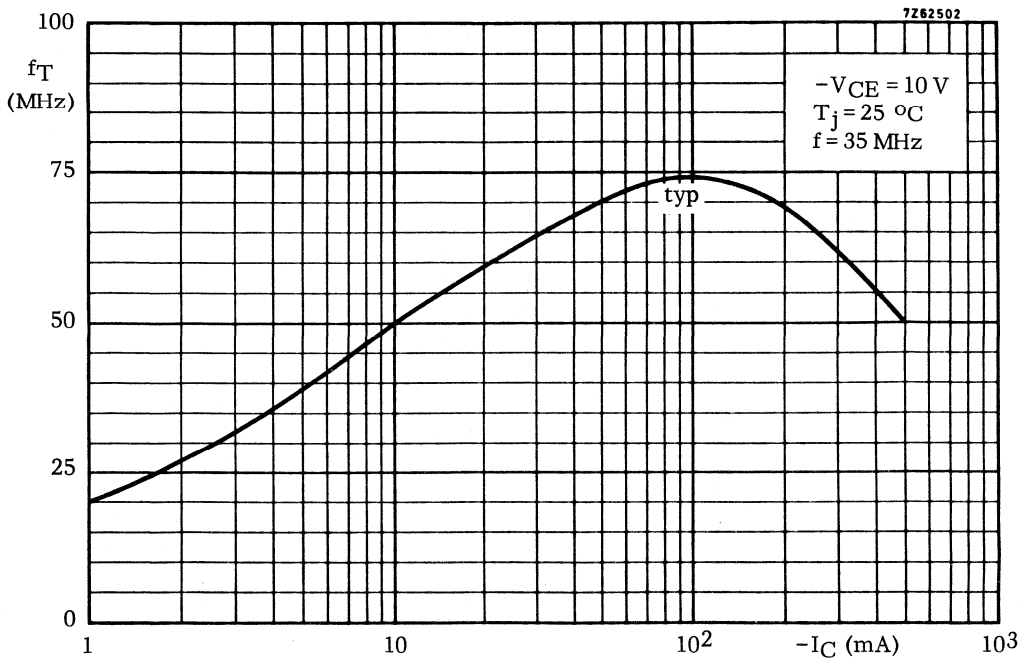

Fig. 11.

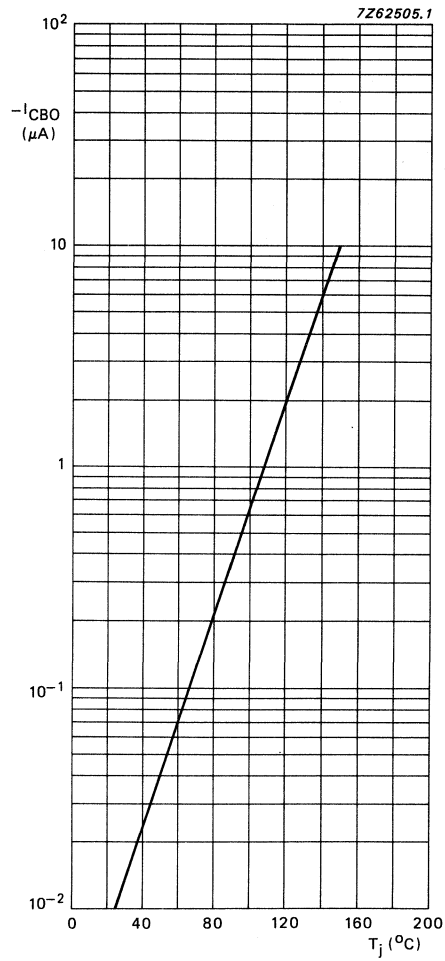

Fig. 12.

$-V_{CBO} = 40 \text{ V}$ ; BSV15;  
 $-V_{CBO} = 60 \text{ V}$ ; BSV16;  
 $-V_{CBO} = 80 \text{ V}$ ; BSV17;  
 typical values.

## SILICON PLANAR EPITAXIAL TRANSISTOR



N-P-N transistor in a TO-39 metal envelope primarily intended for use as a print hammer drive. It has good high current saturation characteristics.

## QUICK REFERENCE DATA

Collector-base voltage (open emitter)	$V_{CBO}$	max.	100 V
Collector-emitter voltage (open base)	$V_{CEO}$	max.	60 V
Collector current (peak value)	$I_{CM}$	max.	5,0 A
Total power dissipation up to $T_{case} = 50\text{ }^{\circ}\text{C}$	$P_{tot}$	max.	5,0 W
Junction temperature	$T_j$	max.	175 $^{\circ}\text{C}$
D.C. current gain	$h_{FE}$	>	40
$I_C = 2\text{ A}; V_{CE} = 2\text{ V}$			
Transition frequency at $f = 35\text{ MHz}$	$f_T$	typ.	100 MHz
$I_C = 0,5\text{ A}; V_{CE} = 5\text{ V}$			
Turn-off time when switched from	$t_{off}$	<	1,2 $\mu\text{s}$
$I_{Con} = 5\text{ A}; I_{Bon} = 0,5\text{ A}$ to cut-off			
with $-I_{Boff} = 0,5\text{ A}$			

## MECHANICAL DATA

Dimensions in mm

Fig. 1 TO-39.

Collector connected to case

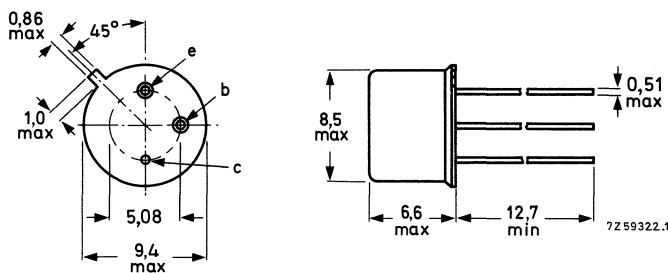

Maximum lead diameter is guaranteed only for 12,7 mm.

**RATINGS**

Limiting values in accordance with the Absolute Maximum System (IEC 134)

Collector-base voltage (open emitter)	$V_{CB0}$	max.	100 V
Collector-emitter voltage ( $R_{BE} \leq 50 \Omega$ )	$V_{CER}$	max.	80 V
Collector-emitter voltage (open base)	$V_{CEO}$	max.	60 V
Emitter-base voltage (open collector)	$V_{EBO}$	max.	5 V
Collector current (d.c.)	$I_C$	max.	2,0 A
Collector current (peak value)	$I_{CM}$	max.	5,0 A
Base current (d.c.)	$I_B$	max.	1,0 A
Total power dissipation up to $T_{case} = 50 \text{ }^\circ\text{C}$	$P_{tot}$	max.	5,0 W
Storage temperature range	$T_{stg}$		-65 to +150 $^\circ\text{C}$
Junction temperature	$T_j$	max.	175 $^\circ\text{C}$

**THERMAL RESISTANCE**From junction to case  $R_{th\ j-c} = 25 \text{ K/W}$ **CHARACTERISTICS** $T_j = 25 \text{ }^\circ\text{C}$ 

Collector cut-off current

 $I_E = 0; V_{CB} = 60 \text{ V}$  $I_{CBO} < 10 \mu\text{A}$ 

Emitter cut-off current

 $I_C = 0; V_{EB} = 4 \text{ V}$  $I_{EBO} < 10 \mu\text{A}$ 

Saturation voltages

 $I_C = 5 \text{ A}; I_B = 0,5 \text{ A}$  $V_{CEsat} < 1,0 \text{ V}$  $V_{BEsat} < 1,8 \text{ V}$ 

D.C. current gain

 $I_C = 2 \text{ A}; V_{CE} = 2 \text{ V}$  $h_{FE} > 40$ Collector capacitance at  $f = 1 \text{ MHz}$  $I_E = I_e = 0; V_{CB} = 10 \text{ V}$  $C_c < 80 \text{ pF}$ Transition frequency at  $f = 35 \text{ MHz}$  $I_C = 0,5 \text{ A}; V_{CE} = 5 \text{ V}$  $f_T \text{ typ. } 100 \text{ MHz}$ 

Switching times

 $I_{Con} = 5 \text{ A}; I_{Bon} = -I_{Boff} = 0,5 \text{ A}$  $-V_{BEoff} = 2 \text{ V}$ 

turn-on time

 $t_{on} < 0,6 \mu\text{s}$ 

turn-off time

 $t_{off} < 1,2 \mu\text{s}$



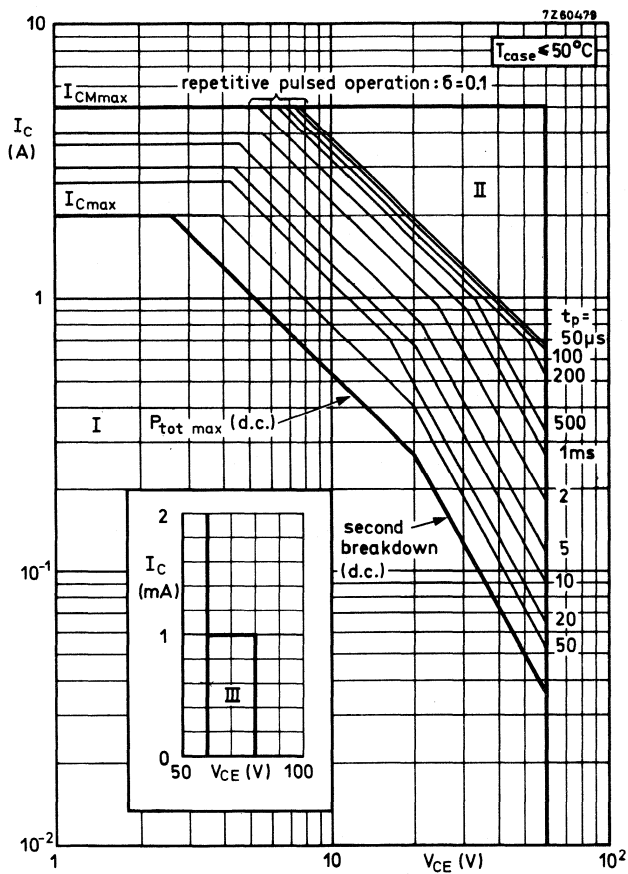

Fig. 2.

Safe Operating Area

- I Region of permissible d.c. operation
- II Permissible extension for repetitive pulsed operation
- III D.C. operation in this region is allowable, provided  $R_{BE} \leq 50 \Omega$ .

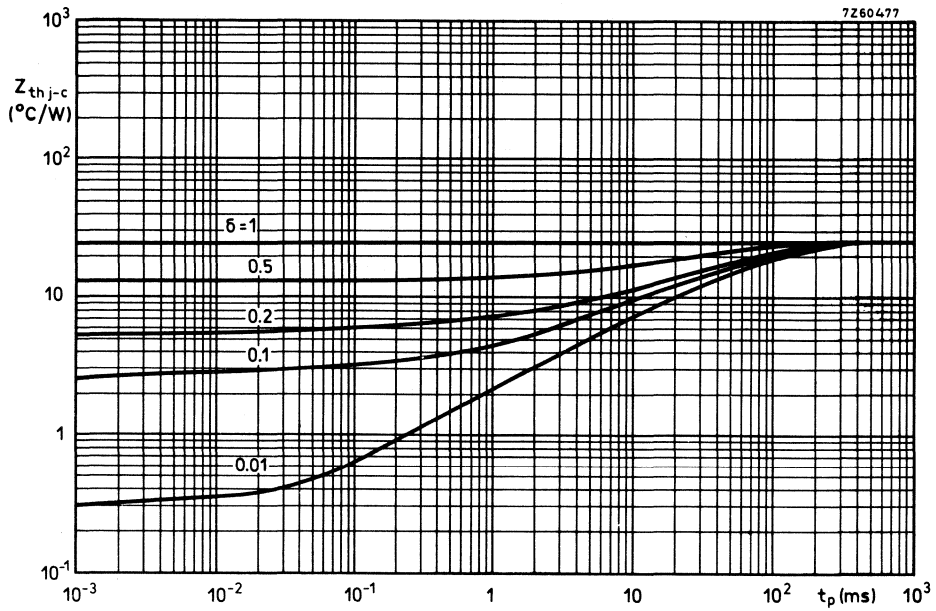

Fig. 3.

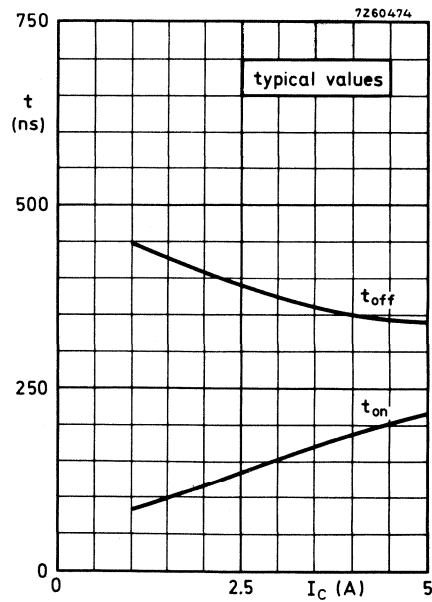

Fig. 4.

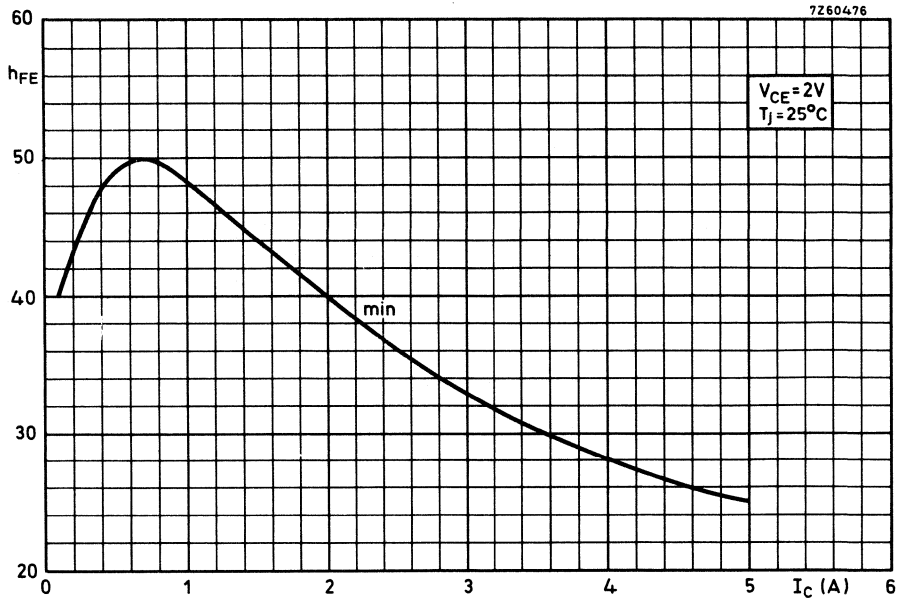

Fig. 5.

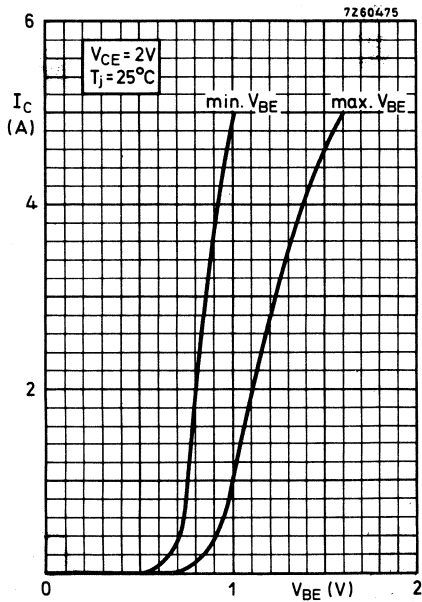

Fig. 6.

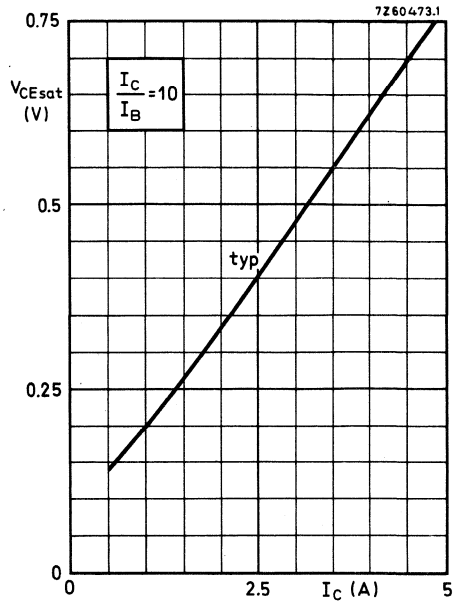

Fig. 7.



## SILICON PLANAR EPITAXIAL TRANSISTORS



N-P-N transistors primarily intended for general purpose industrial and switching applications.

## QUICK REFERENCE DATA

		BSW66A			BSW67A	BSW68A	
Collector-base voltage (open emitter)	$V_{CBO}$	max.	100	120	150	V	
Collector-emitter voltage (open base)	$V_{CEO}$	max.	100	120	150	V	
Collector current (peak value)	$I_{CM}$	max.	2			A	
Total power dissipation up to $T_{case} = 25\text{ }^{\circ}\text{C}$	$P_{tot}$	max.	5,0			W	
Collector-emitter saturation voltage $I_C = 500\text{ mA}; I_B = 50\text{ mA}$	$V_{CEsat}$	<	400			mV	
D.C. current gain $I_C = 10\text{ mA}; V_{CE} = 5\text{ V}$	$h_{FE}$	>	30				
$I_C = 500\text{ mA}; V_{CE} = 5\text{ V}$	$h_{FE}$	>	30				
Transition frequency at $f = 35\text{ MHz}$ $I_C = 100\text{ mA}; V_{CE} = 20\text{ V}$	$f_T$	typ.	130			MHz	

## MECHANICAL DATA

Dimensions in mm

Fig. 1 TO-39.

Collector connected to case.

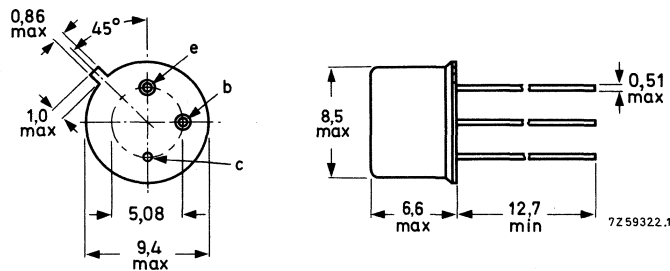

Maximum lead diameter is guaranteed only for 12,7 mm.

## RATINGS

Limiting values in accordance with the Absolute Maximum System (IEC 134)

			BSW66A	BSW67A	BSW68A	
Collector-base voltage (open emitter)	$V_{CBO}$	max.	100	120	150	V
Collector-emitter voltage (open base) *	$V_{CEO}$	max.	100	120	150	V
Emitter-base voltage (open collector)	$V_{EBO}$	max.	6	6	6	V
Collector current (d.c. or average)	$I_C$	max.	1			A
Collector current (peak value; $t_p \leq 20$ ms)	$I_{CM}$	max.	2			A
Total power dissipation up to						
$T_{amb} = 25$ °C	$P_{tot}$	max.	0,8			W
$T_{case} = 25$ °C	$P_{tot}$	max.	5,0			W
Storage temperature range	$T_{stg}$		-65 to + 150			°C
Junction temperature	$T_j$	max.	200			°C

## THERMAL RESISTANCE

From junction to ambient in free air	$R_{th\ j-a}$	=	220	K/W
From junction to case	$R_{th\ j-c}$	=	35	K/W

## CHARACTERISTICS

$T_j = 25$  °C unless otherwise specified

Collector cut-off current

$I_E = 0; V_{CB} = V_{CBOmax}$	$I_{CBO}$	<	100	$\mu$ A
$I_E = 0; V_{CB} = \frac{1}{2}V_{CBOmax}$	$I_{CBO}$	<	100	nA
$I_E = 0; V_{CB} = \frac{1}{2}V_{CBOmax}; T_j = 150$ °C	$I_{CBO}$	<	50	$\mu$ A

Emitter cut-off current

$I_C = 0; V_{EB} = 6$ V	$I_{EBO}$	<	100	$\mu$ A
$I_C = 0; V_{EB} = 3$ V	$I_{EBO}$	<	100	nA

Collector-emitter breakdown voltage

			BSW66A	BSW67A	BSW68A	
$I_B = 0; I_C = 10$ mA	$V_{(BR)CEO}$	>	100	120	150	V

Saturation voltages

$I_C = 100$ mA; $I_B = 10$ mA	$V_{CEsat}$	<	150	mV
	$V_{BEsat}$	<	900	mV
$I_C = 500$ mA; $I_B = 50$ mA	$V_{CEsat}$	<	400	mV
	$V_{BEsat}$	<	1,1	V
$I_C = 1,0$ A; $I_B = 150$ mA	$V_{CEsat}$	<	1,0	V
	$V_{BEsat}$	<	1,4	V

\* See Application Information

## D.C. current gain

$$I_C = 10 \text{ mA}; V_{CE} = 5 \text{ V}$$

$$h_{FE} > 30$$

$$I_C = 100 \text{ mA}; V_{CE} = 5 \text{ V}$$

$$h_{FE} > 40$$

$$I_C = 500 \text{ mA}; V_{CE} = 5 \text{ V}$$

$$h_{FE} > 30$$

$$I_C = 1,0 \text{ A}; V_{CE} = 5 \text{ V}$$

$$h_{FE} > 10$$

Collector capacitance at  $f = 1 \text{ MHz}$ 

$$I_E = I_e = 0; V_{CB} = 10 \text{ V}$$

$$C_c < 20 \text{ pF}$$

Emitter capacitance at  $f = 1 \text{ MHz}$ 

$$I_C = I_c = 0; V_{EB} = 0$$

$$C_e < 300 \text{ pF}$$

Transition frequency at  $f = 35 \text{ MHz}$ 

$$I_C = 100 \text{ mA}; V_{CE} = 20 \text{ V}$$

$$f_T \text{ typ. } 130 \text{ MHz}$$

## Turn-on time (see Fig. 2)

$$I_{Con} = 500 \text{ mA}; I_{Bon} = 50 \text{ mA}; -V_{BEoff} = 4 \text{ V}$$

$$t_{on} \text{ typ. } 0,5 \mu\text{s}$$

## Turn-off time (see Fig. 2)

$$I_{Con} = 500 \text{ mA}; I_{Boff} = -50 \text{ mA}$$

$$t_{off} \text{ typ. } 0,9 \mu\text{s}$$

## Pulse generator:

$$t_p \geq 5 \mu\text{s}$$

$$t_r \leq 10 \text{ ns}$$

$$t_f \leq 10 \text{ ns}$$

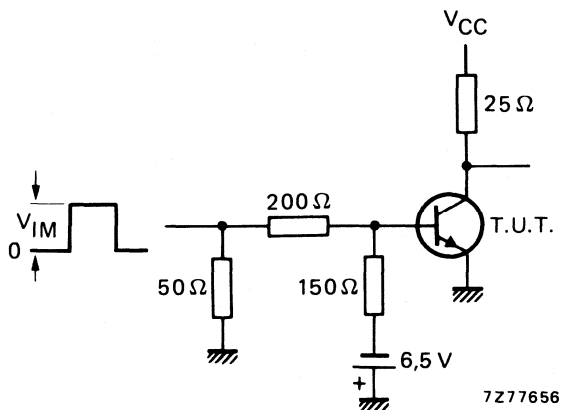

Fig. 2 Test circuit for saturated switching characteristics.  
 $V_{CC} = 13 \text{ V}; V_{IM} = 21 \text{ V}.$

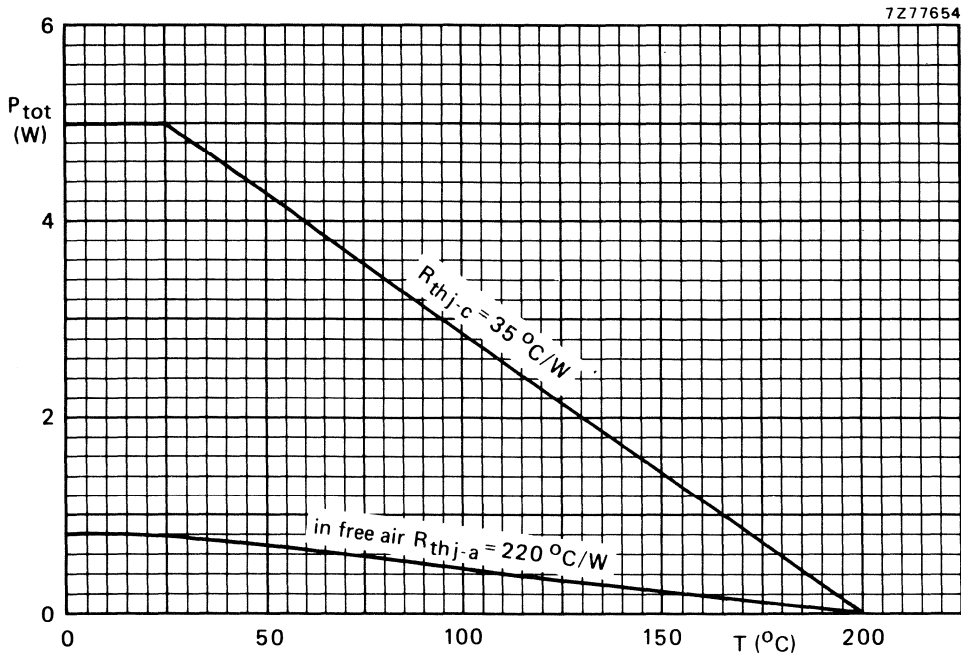

Fig. 3 Maximum permissible power dissipation versus temperature.

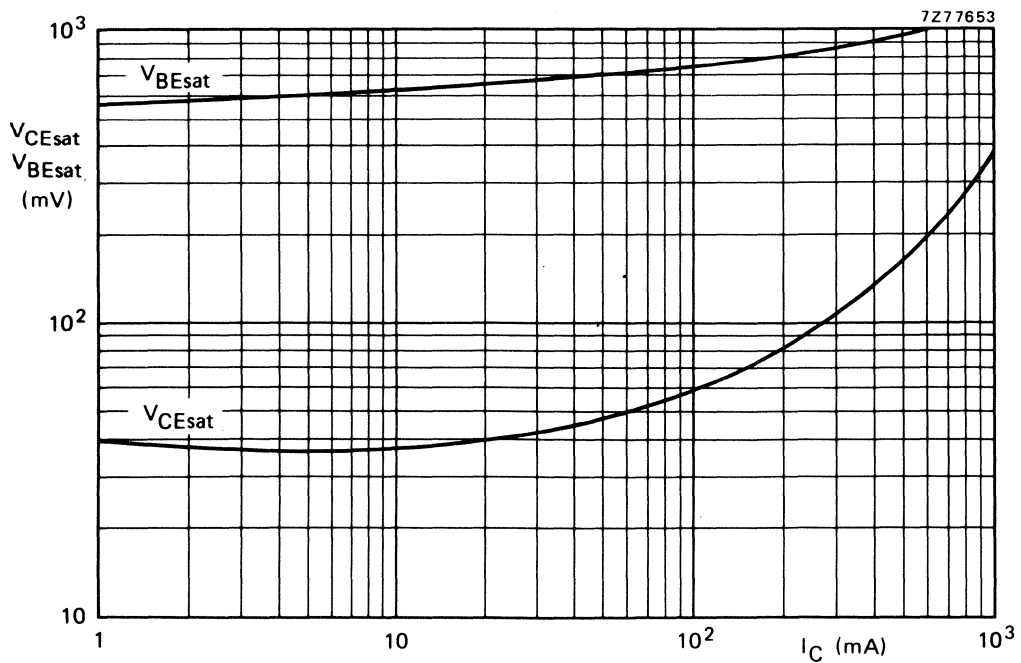

Fig. 4  $I_C/I_B = 10$ ;  $T_j = 25\text{ }^{\circ}\text{C}$ ; typical values.



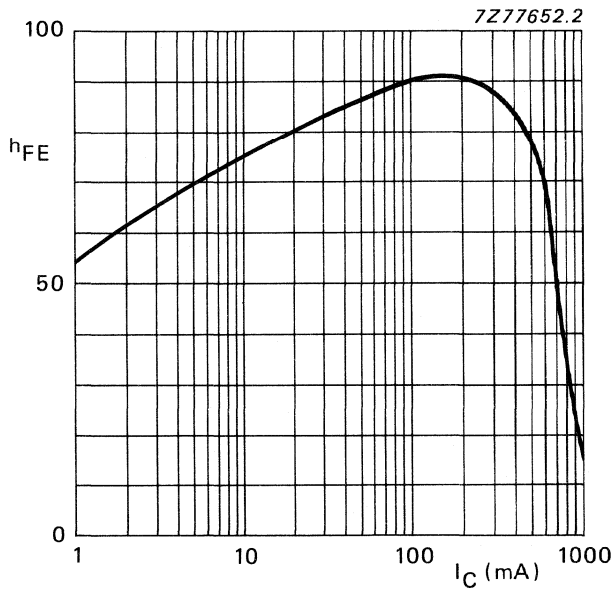

Fig. 5  $V_{CE}$  5 V;  $T_j = 25^\circ C$ ; typical values.

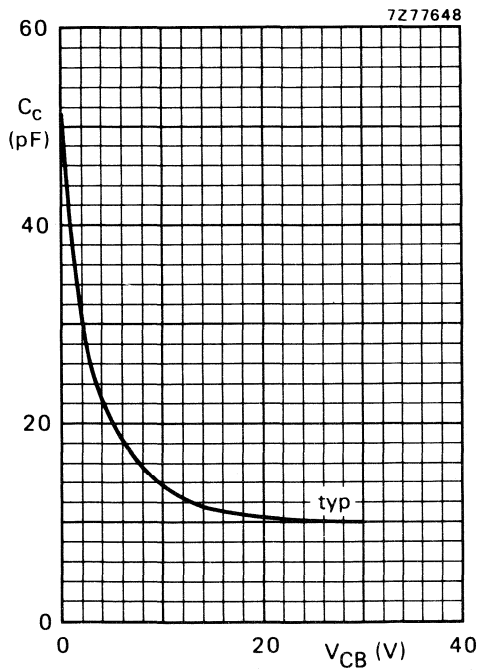

Fig. 6  $I_E = I_e = 0$ ;  $T_j = 25^\circ C$ .

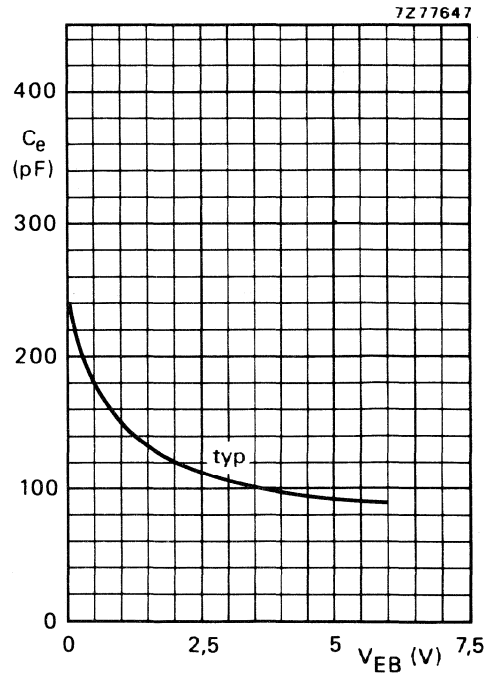

Fig. 7  $I_C = I_c = 0$ ;  $T_j = 25^\circ C$ .

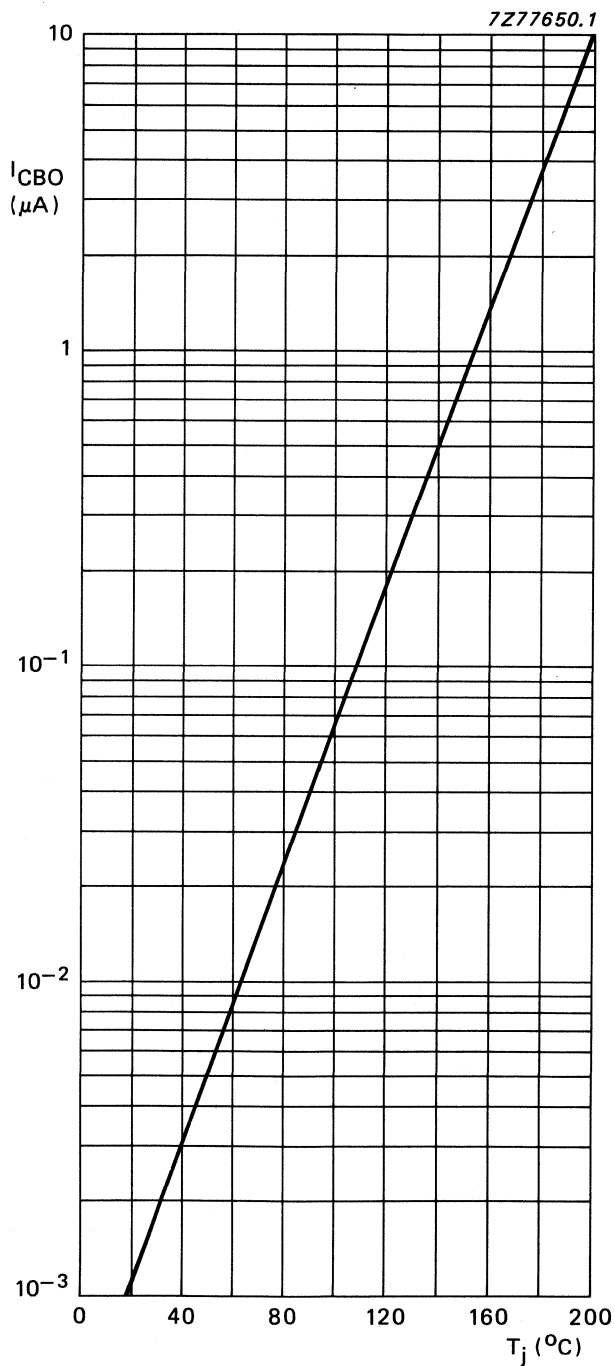

Fig. 8  $V_{CB} = V_{CBOmax}$ ; typical values.

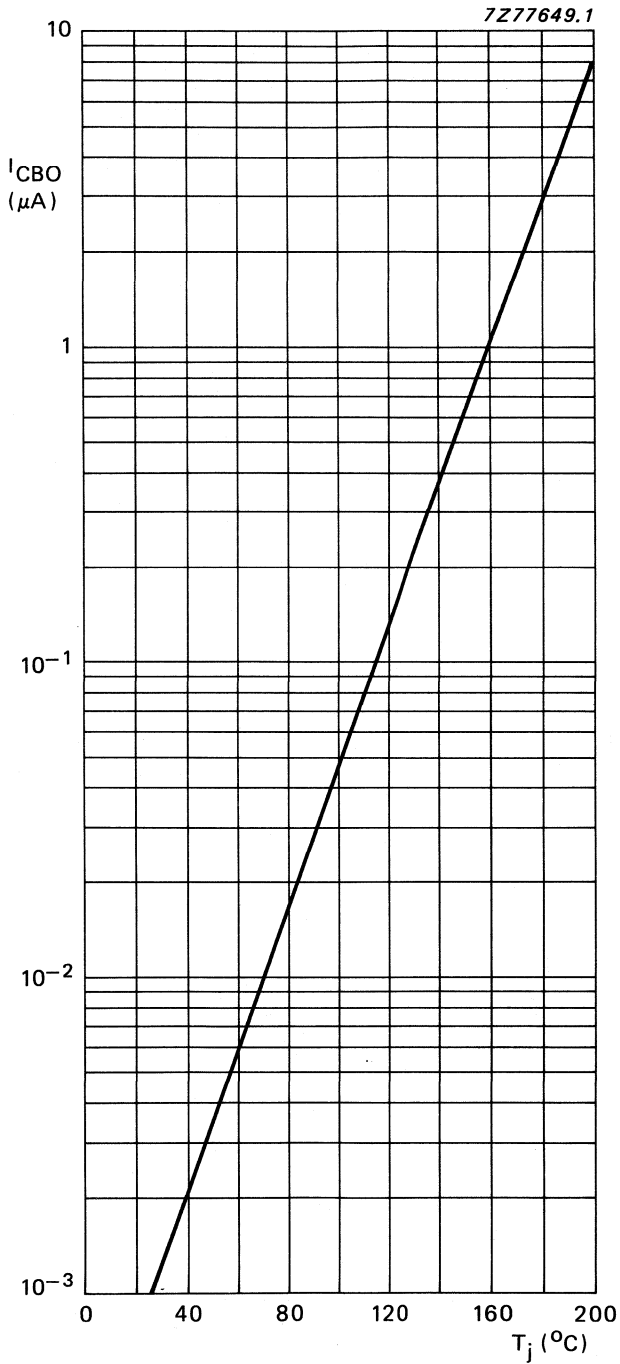

Fig. 9  $V_{CB} = \frac{1}{2}V_{CBOmax}$ ; typical values.

## APPLICATION INFORMATION

## Clamped inductive load turn-off capability

With a base-emitter resistance of  $\geq 330 \Omega$ , i.e. an available reverse base current of  $\leq 2 \text{ mA}$ , and the maximum permitted clamping voltage i.e. the rated  $V_{CE0\text{max}}$ , the transistor will be free from second-breakdown effects when turning off from collector current values up to the rated  $I_{CM\text{max}}$  of 2 A. See Figs 10 and 11.

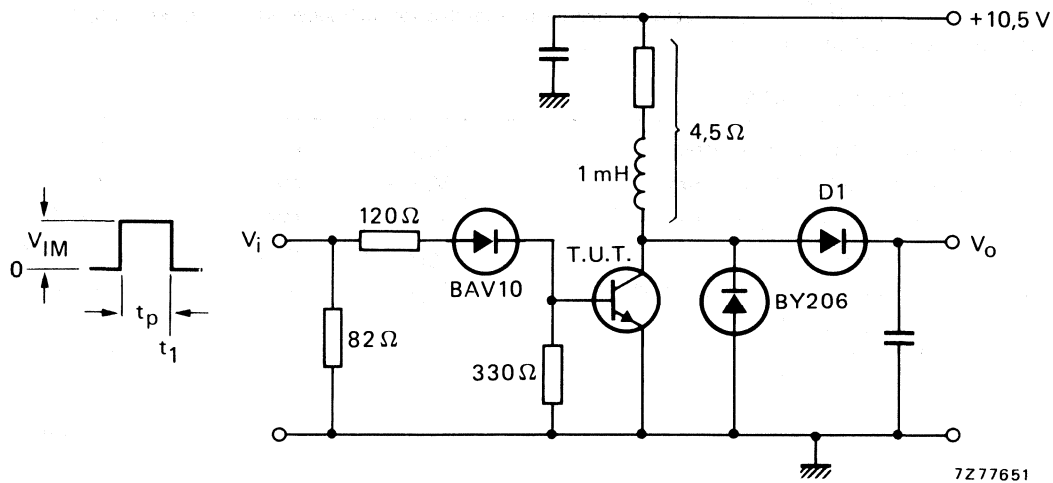

Fig. 10 Test circuit:  $V_{IM} = 50 \text{ V}$ ;  $t_p = 3 \text{ ms}$ ;  $\delta \leq 0,03$ .  
 D1 = BY206 or combinations of suitable faster diodes.  
 $V_o$  Adjusted to make  $V_{(CL)}$  equal to rated  $V_{CE0\text{max}}$  (see Fig. 11).

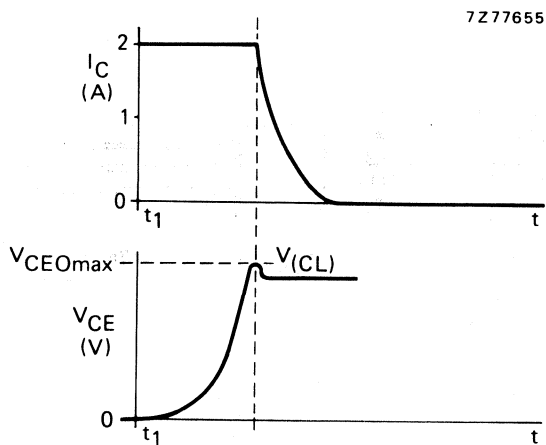

Fig. 11 Waveforms.

## SILICON PLANAR EPITAXIAL TRANSISTORS

NPN transistors in TO-18 metal envelopes, primarily intended for high-speed saturated switching and HF amplifier applications.

### QUICK REFERENCE DATA

Collector-base voltage (open emitter)	$V_{CB0}$	max.	40 V
Collector-emitter voltage (open base)	$V_{CE0}$	max.	15 V
Collector-emitter voltage ( $V_{BE} = 0$ )	$V_{CES}$	max.	40 V
Collector current (peak value)	$I_{CM}$	max.	500 mA
Total power dissipation up to $T_{amb} = 25\text{ }^{\circ}\text{C}$	$P_{tot}$	max.	360 mW
DC current gain at $T_j = 25\text{ }^{\circ}\text{C}$			
$I_C = 10\text{ mA}; V_{CE} = 1\text{ V}$	$h_{FE}$		40 to 120
$I_C = 100\text{ mA}; V_{CE} = 2\text{ V}$	$h_{FE}$	min.	20
Transition frequency			
$I_C = 10\text{ mA}; V_{CE} = 10\text{ V}$	$f_T$	min.	500 MHz
Storage time			
$I_C = I_B = -I_{BM} = 10\text{ mA}$	$t_s$	max.	13 ns

### MECHANICAL DATA

Dimensions in mm

Fig.1 TO-18.

Collector connected to case

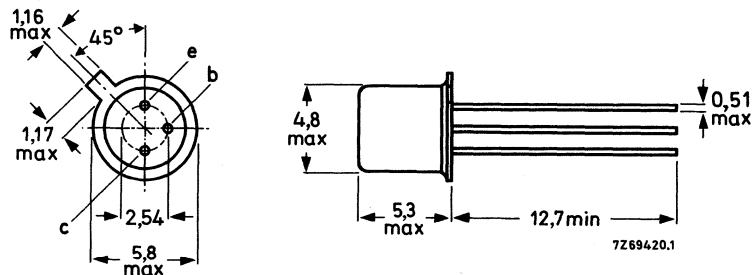

**RATINGS**

Limiting values in accordance with the Absolute Maximum System (IEC 134)

Collector-base voltage (open emitter)	$V_{CBO}$	max.	40 V
Collector-emitter voltage (open base)	$V_{CEO}$	max.	15 V
Collector-emitter voltage with $V_{BE} = 0$	$V_{CES}$	max.	40 V
Emitter-base voltage (open collector)	$V_{EBO}$	max.	4.5 V
Collector current (peak value; $t = 10 \mu s$ )	$I_{CM}$	max.	500 mA
Total power dissipation up to $T_{amb} = 25 \text{ }^\circ\text{C}$	$P_{tot}$	max.	360 mW
Storage temperature range	$T_{stg}$	-65 to +150	$^\circ\text{C}$
Junction temperature	$T_j$	max.	200 $^\circ\text{C}$

**THERMAL RESISTANCE**

From junction to ambient in free air	$R_{th j-a}$	=	480 K/W
From junction to case	$R_{th j-c}$	=	150 K/W

**CHARACTERISTICS**

$T_j = 25\text{ }^\circ\text{C}$  unless otherwise specified

Collector cut-off current

$I_E = 0; V_{CB} = 20\text{ V}$	$I_{CBO}$	max.	400 nA
$I_E = 0; V_{CB} = 20\text{ V}; T_j = 150\text{ }^\circ\text{C}$	$I_{CBO}$	max.	30 $\mu\text{A}$
$V_{BE} = 0; V_{CE} = 15\text{ V}; T_j = 55\text{ }^\circ\text{C}$	$I_{CES}$	max.	0.40 $\mu\text{A}$
$V_{BE} = 0; V_{CE} = 40\text{ V}$	$I_{CES}$	max.	1.0 $\mu\text{A}$

Emitter cut-off current

$I_C = 0; V_{EB} = 4.5\text{ V}$	$I_{EBO}$	max.	10 $\mu\text{A}$
----------------------------------	-----------	------	------------------

Currents at reverse biased emitter junction

$V_{CE} = 15\text{ V}; -V_{BE} = 3\text{ V}; T_j = 55\text{ }^\circ\text{C}$	$I_{CEX}$	max.	0.60 $\mu\text{A}$
	$-I_{BEX}$	max.	0.60 $\mu\text{A}$

Sustaining voltages

$I_C = 10\text{ mA}; I_B = 0$	$V_{CEOsust}$	min.	15 V
$I_C = 10\text{ mA}; R_{BE} = 10\ \Omega$	$V_{CERsust}$	min.	20 V

Base-emitter voltage (see also Fig.6)

$I_C = 30\ \mu\text{A}; V_{CE} = 20\text{ V}; T_j = 100\text{ }^\circ\text{C}$	$V_{BE}$	min.	0.35 V
--	----------	------	--------

Saturation voltages

$I_C = 10\text{ mA}; I_B = 0.3\text{ mA}$	$V_{CEsat}$	max.	0.3 V
$I_C = 10\text{ mA}; I_B = 1\text{ mA}$	$V_{CEsat}$	max.	0.25 V
	$V_{BEsat}$		0.70 to 0.85 V
$I_C = 100\text{ mA}; I_B = 10\text{ mA}$	$V_{CEsat}$	max.	0.60 V
	$V_{BEsat}$	max.	1.50 V

Collector capacitance at  $f = 1\text{ MHz}$

$I_E = I_e = 0; V_{CB} = 5\text{ V}$	$C_c$	max.	4 pF
--------------------------------------	-------	------	------

Emitter capacitance at  $f = 1\text{ MHz}$

$I_C = I_c = 0; V_{EB} = 1\text{ V}$	$C_e$	max.	4.5 pF
--------------------------------------	-------	------	--------

**CHARACTERISTICS** (continued)

DC current gain

$I_C = 10 \text{ mA}; V_{CE} = 1 \text{ V}$	$h_{FE}$	40 to 120
$I_C = 10 \text{ mA}; V_{CE} = 1 \text{ V}; T_j = -55 \text{ }^\circ\text{C}$	$h_{FE}$ min.	20
$I_C = 100 \text{ mA}; V_{CE} = 2 \text{ V}$	$h_{FE}$ min.	20

Transition frequency

$I_C = 10 \text{ mA}; V_{CE} = 10 \text{ V}$	$f_T$ min.	500 MHz
	$f_T$ typ.	600 MHz

Switching times

Storage time ( see also relevant Figs. )

$I_C = I_B = -I_{BM} = 10 \text{ mA}$	$t_s$ typ.	6 ns
	$t_s$ max.	13 ns

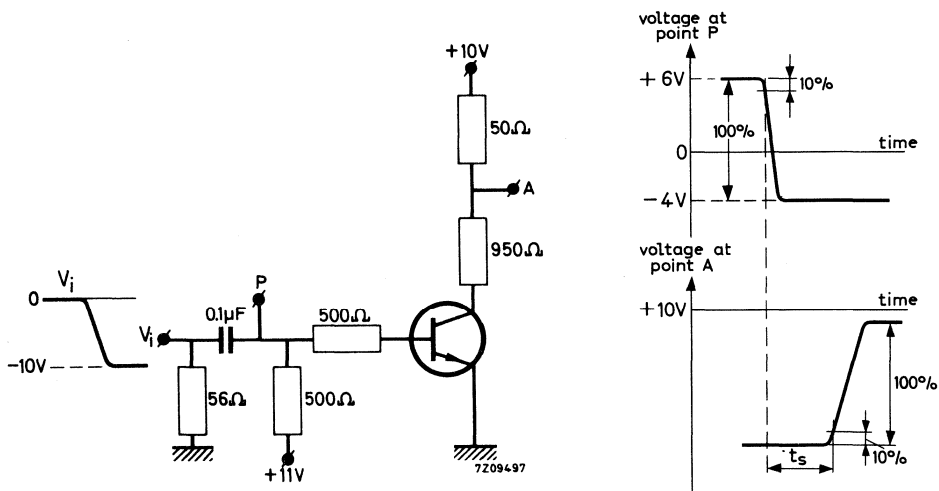

Fig. 2 Test circuit and timing waveforms.

Pulse generator:

Rise time	$t_R < 1 \text{ ns}$
Pulse duration	$t > 300 \text{ ns}$
Duty cycle	$\delta < 0.02$
Source impedance	$R_S = 50 \text{ } \Omega$

Oscilloscope:

Input impedance	$R_i = 50 \text{ } \Omega$
Rise time	$t_R < 1 \text{ ns}$



Switching times

Turn on time ( see also relevant Figs.)

from  $-V_{BE} = 1.5 \text{ V}$  to  $I_C = 10 \text{ mA}$ ;  $I_B = 3 \text{ mA}$   
 from  $-V_{BE} = 2.25 \text{ V}$  to  $I_C = 100 \text{ mA}$ ;  $I_B = 40 \text{ mA}$

$t_{ON} \text{ max. } 12 \text{ ns}$   
 $t_{ON} \text{ max. } 7 \text{ ns}$

Turn off time ( see also relevant Figs. )

from  $I_C = 10 \text{ mA}$ ;  $I_B = 3 \text{ mA}$   
 to cut-off with  $-I_{BM} = 1.5 \text{ mA}$   
 from  $I_C = 100 \text{ mA}$ ;  $I_B = 40 \text{ mA}$  to cut-off  
 with  $-I_{BM} = 20 \text{ mA}$

$t_{Off} \text{ max. } 18 \text{ ns}$   
 $t_{Off} \text{ max. } 21 \text{ ns}$

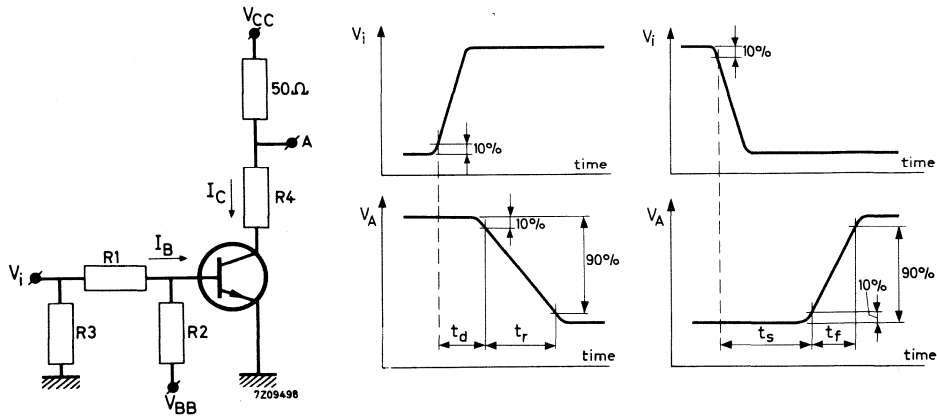

Fig. 3 Test circuit and timing waveforms.

Pulse generator:

Rise time  $t_r < 1 \text{ ns}$   
 Pulse duration  $t > 300 \text{ ns}$   
 Duty cycle  $\delta < 0.02$   
 Source impedance  $R_S = 50 \Omega$

Oscilloscope:

Input impedance  $R_i = 50 \Omega$   
 Rise time  $t_r < 1 \text{ ns}$

$I_C$ (mA)	$I_B$ (mA)	$-I_{BM}$ (mA)	$V_{CC}$ (V)	R1;R2 (kΩ)	R3 (Ω)	R4 (Ω)	turn on time			turn off time	
							$-V_{BB}$ (V)	$-V_{BE}$ (V)	$V_i$ (V)	$V_{BB}$ (V)	$-V_i$ (V)
10	3	1.5	3	3.3	50	220	3.0	1.5	15	12.0	15
100	40	20	6	0.33	56	0	4.5	2.25	20	15.3	20

Note

$-I_{BM}$  is the reverse current that can flow during switching off. The indicated  $-I_{BM}$  is determined and limited by the applied cut-off voltage and series resistance.

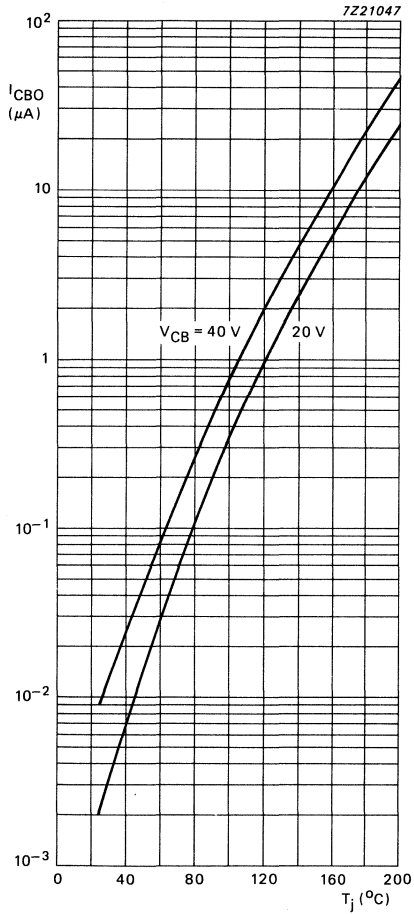

Fig.4.

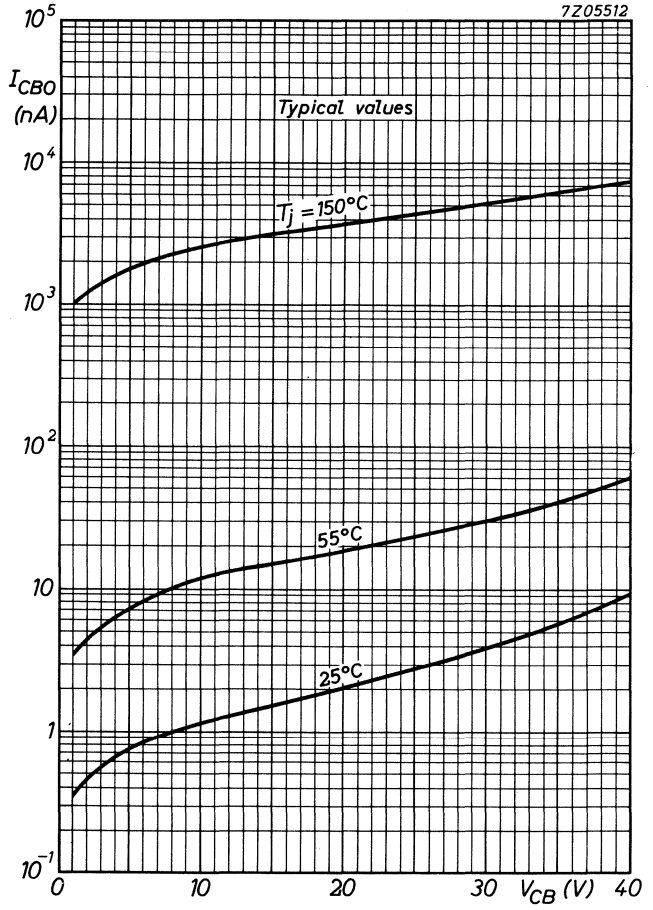

Fig.5.

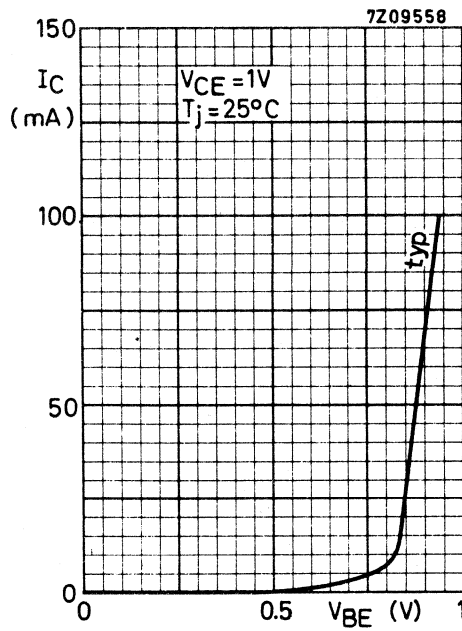

Fig.6.

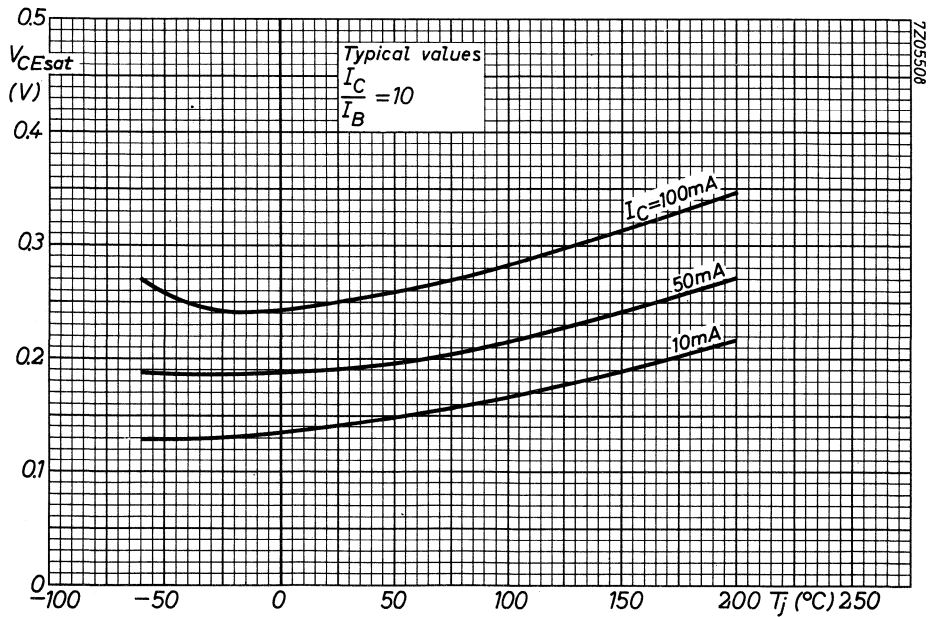

Fig.7.

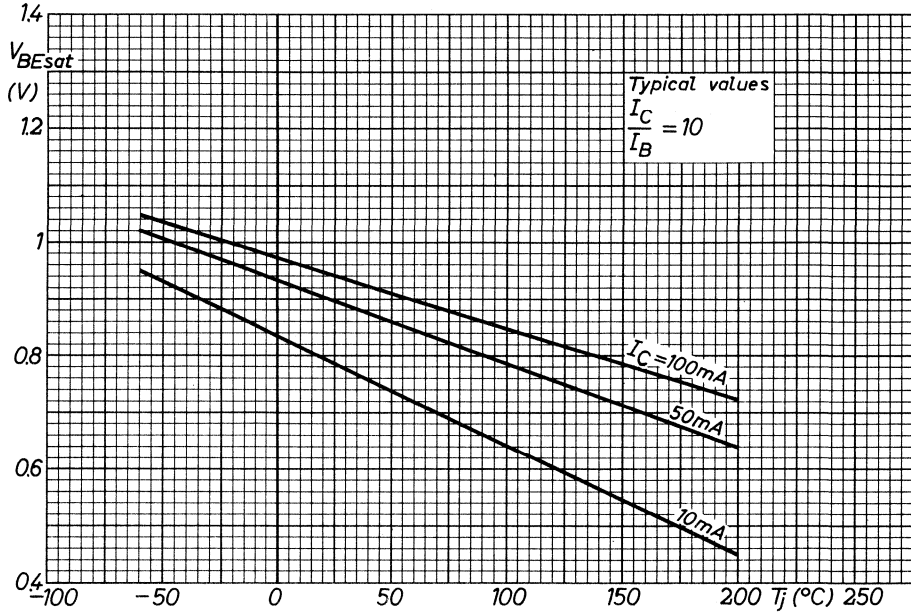

Fig.8.

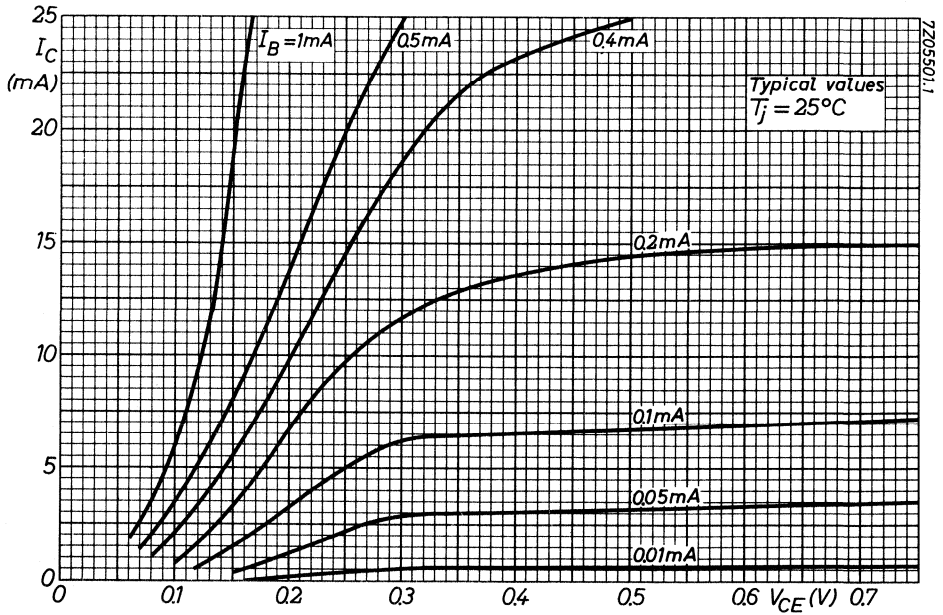

Fig.9.

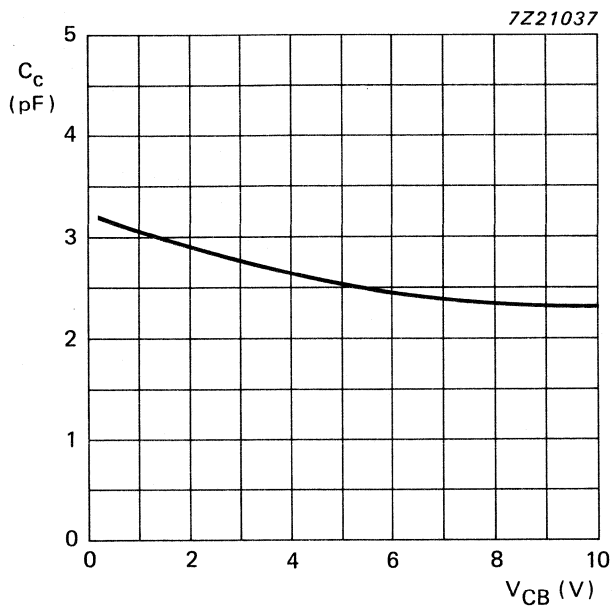

Fig.10  $T_j = 25\text{ }^\circ\text{C}$ ;  $f = 1\text{ MHz}$ ;  $I_E = I_c = 0$ .

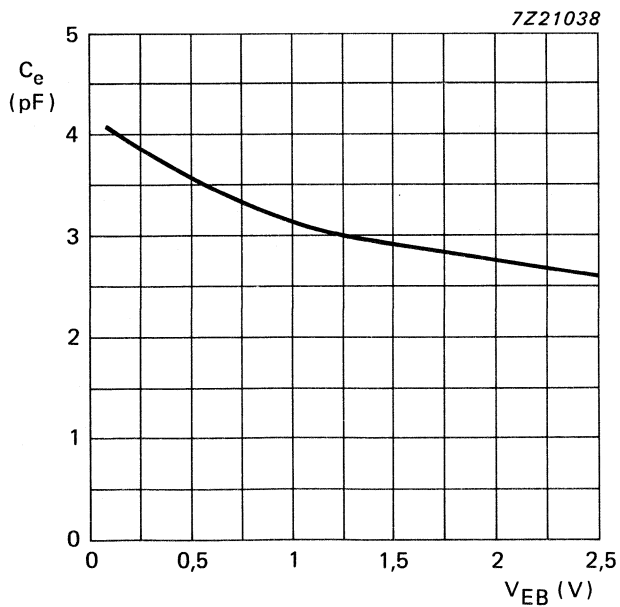

Fig.11  $T_j = 25\text{ }^\circ\text{C}$ ;  $f = 1\text{ MHz}$ ;  $I_C = I_c = 0$ .

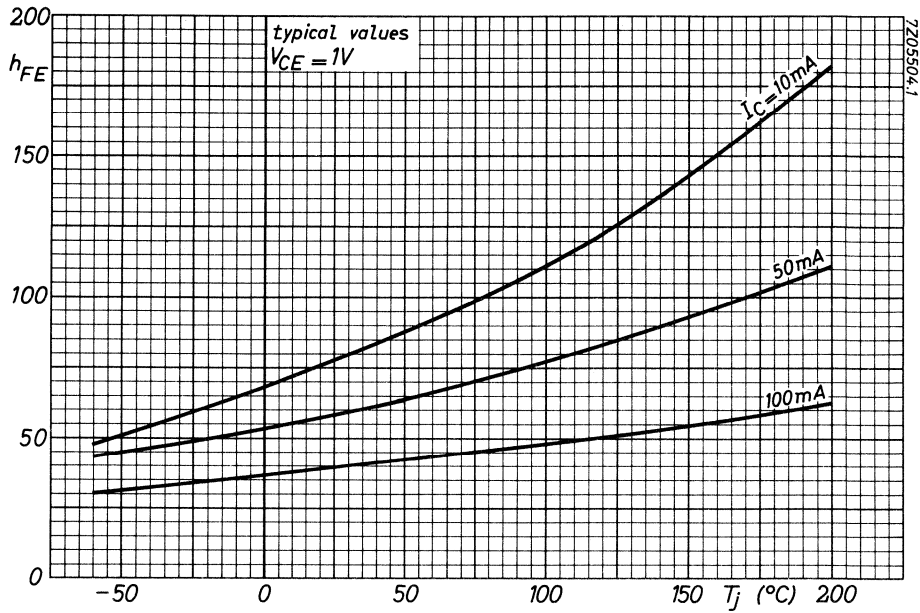

Fig.12.

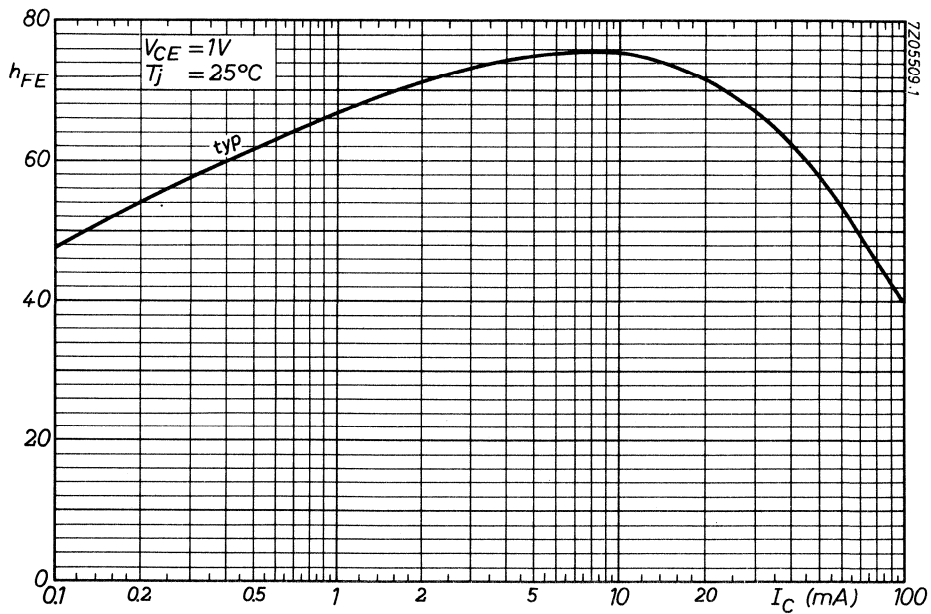

Fig.13.

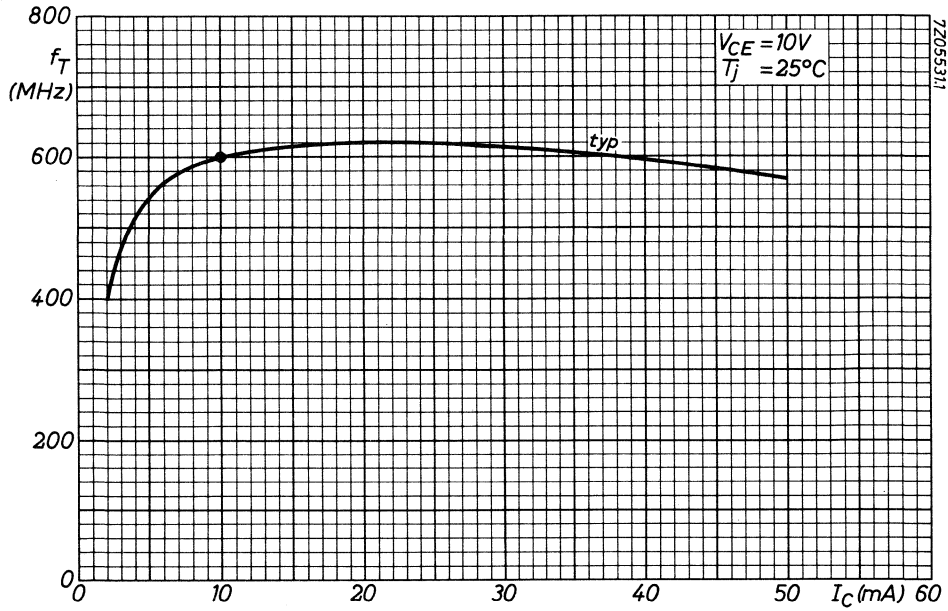

Fig. 14.

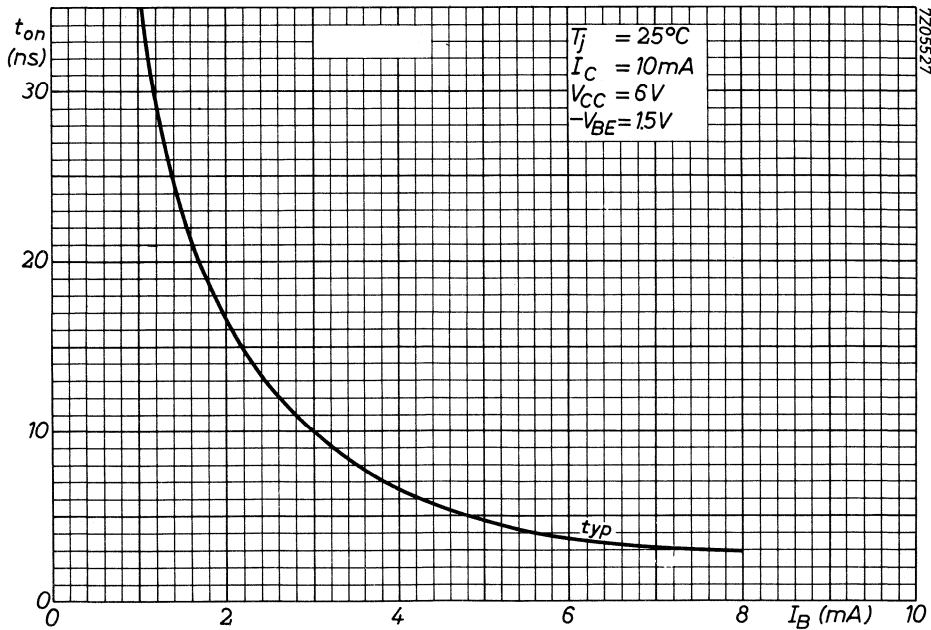

Fig. 15.

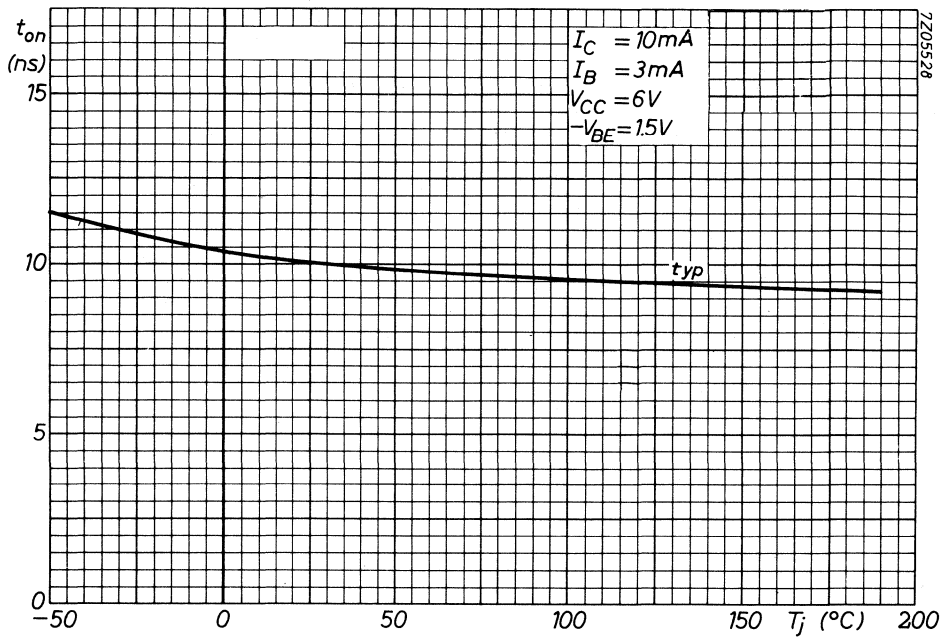

Fig. 16.

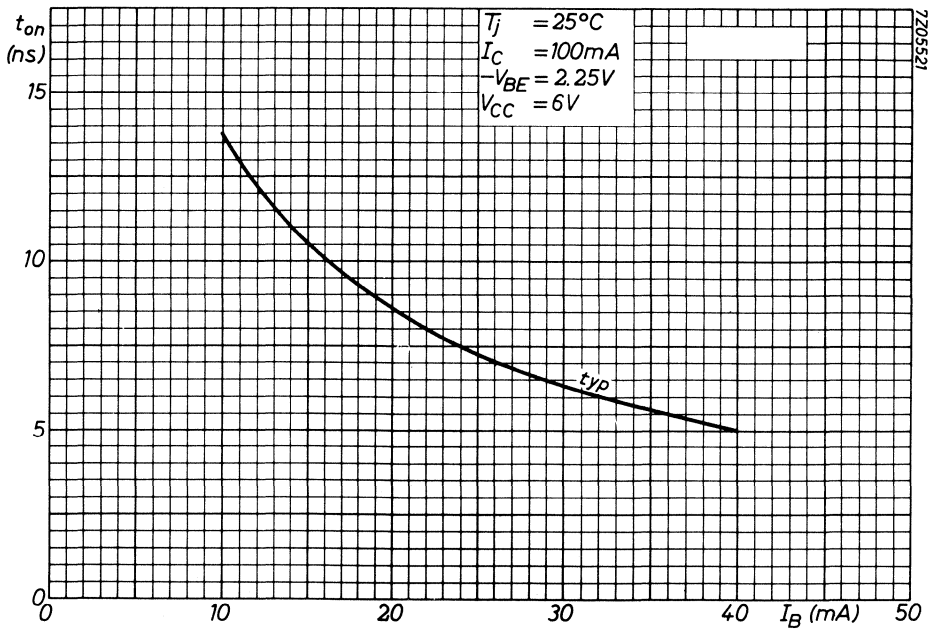

Fig. 17.



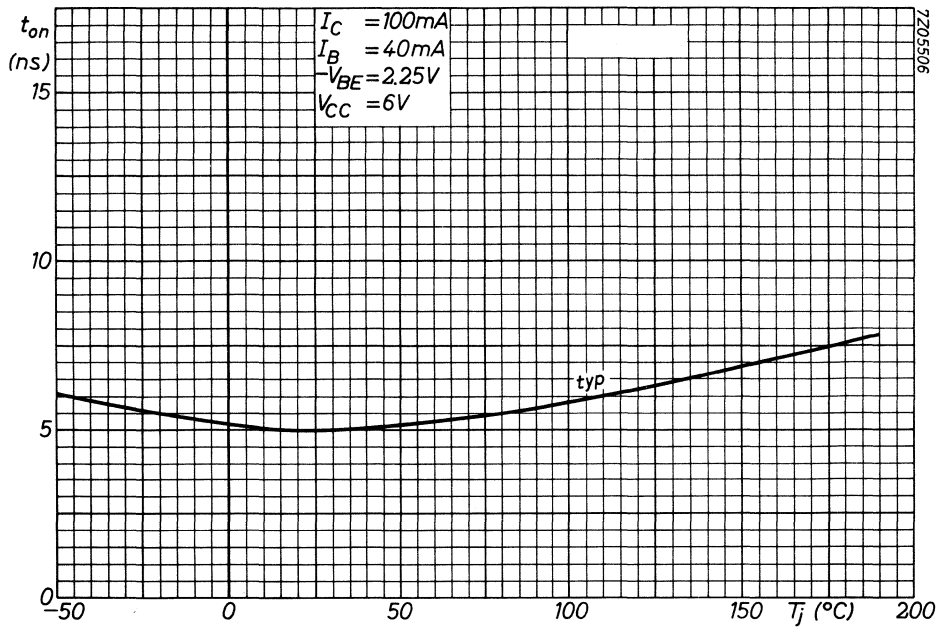

Fig. 18.

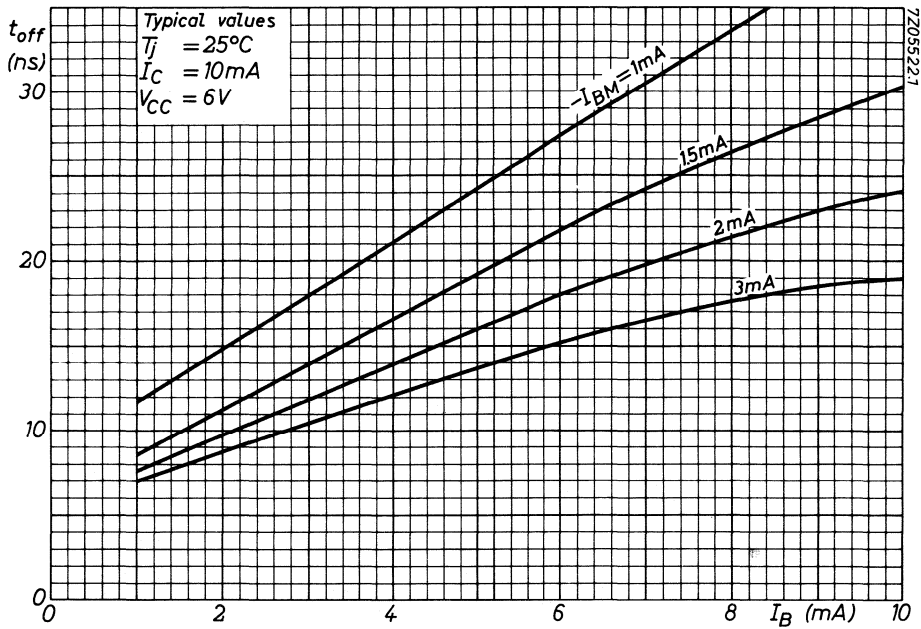

Fig. 19.

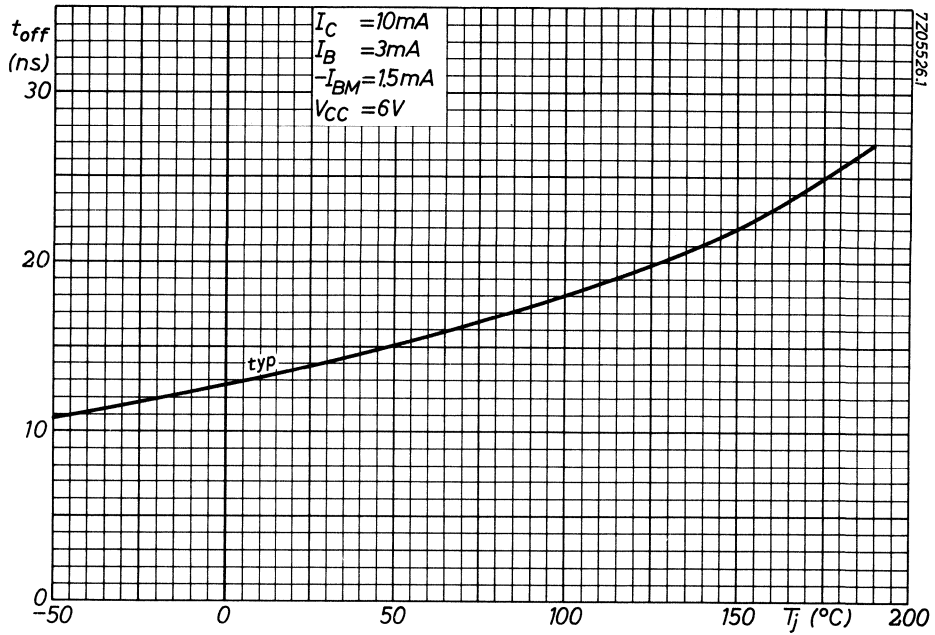

Fig.20.

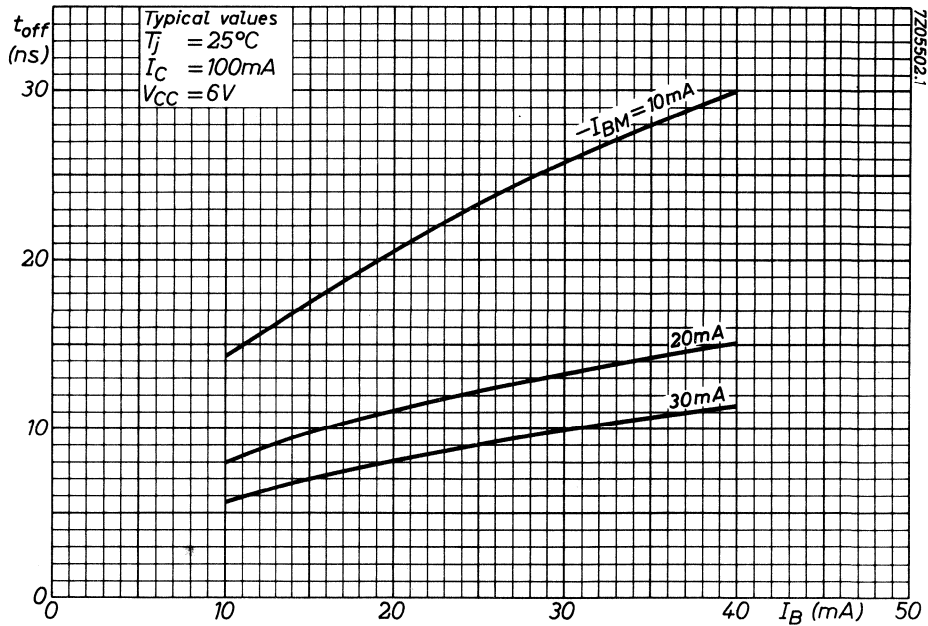

Fig.21.

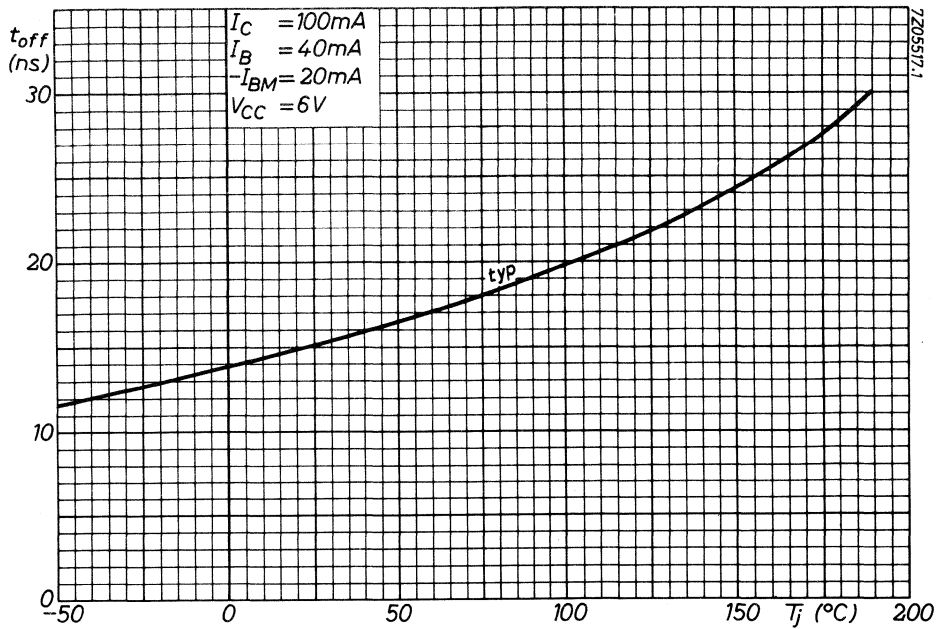

Fig.22.

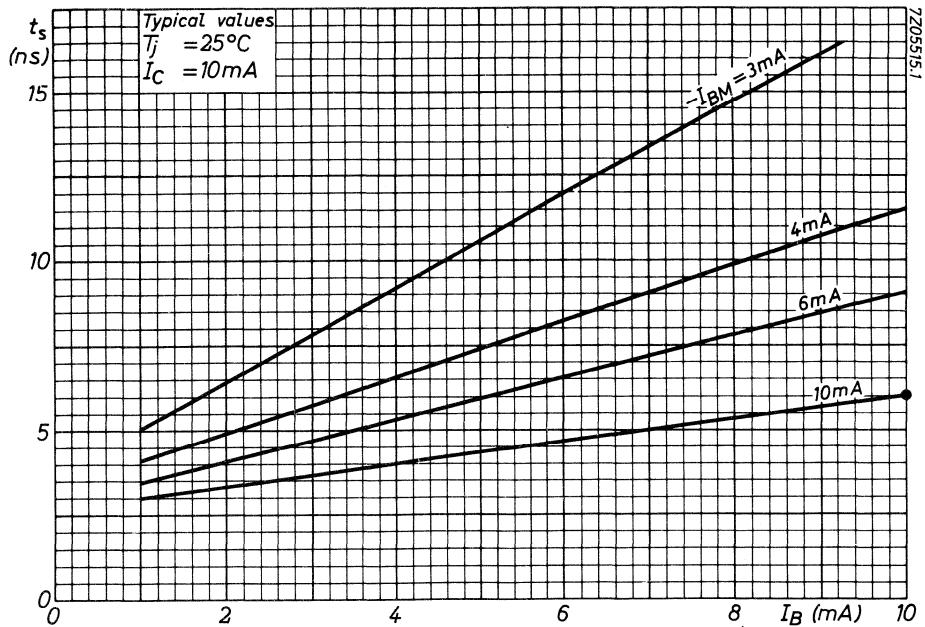

Fig.23.

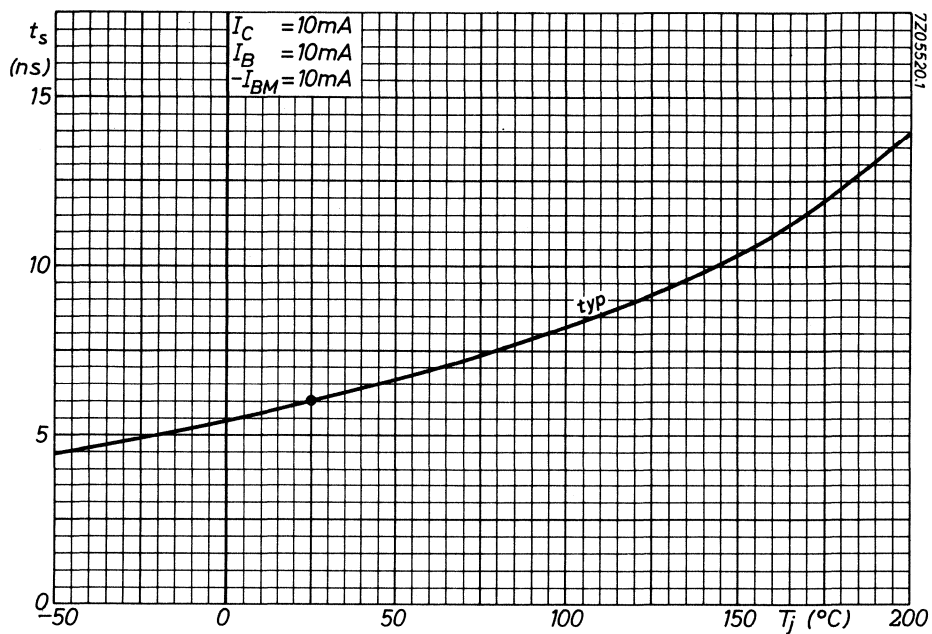

Fig.24.

## SILICON PLANAR EPITAXIAL TRANSISTOR

N-P-N silicon planar epitaxial transistor in a TO-39 encapsulation.

The BSX32 is designed for use in high current switching applications.

### QUICK REFERENCE DATA

Collector-base voltage (open emitter)	$V_{CBO}$	max.	65 V
Collector-emitter voltage (open base)	$V_{CEO}$	max.	40 V
Emitter-base voltage (open collector)	$V_{EBO}$	max.	6 V
Collector current	$I_C$	max.	1 A
D.C. current gain	$h_{FE}$	min.	20
$I_C = 1 \text{ A}; V_{CE} = 5 \text{ V}$		typ.	60
Total power dissipation up to $T_{amb} = 25 \text{ }^\circ\text{C}$	$P_{tot}$	max.	800 mW
Junction temperature	$T_j$	max.	200 $^\circ\text{C}$
Transition frequency at $f = 100 \text{ MHz}$	$f_T$	min.	300 MHz
$I_C = 50 \text{ mA}; V_{CE} = 10 \text{ V}$			

Fig. 1 TO-39.

Dimensions in mm

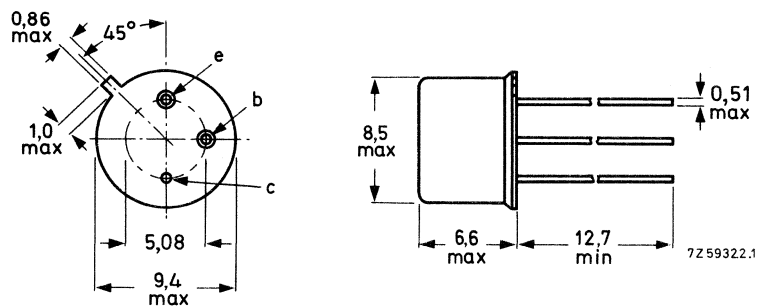

**RATINGS**

Limiting values in accordance with the Absolute Maximum System (IEC 134)

Collector-base voltage (open emitter)	$V_{CBO}$	max.	65 V
Collector-emitter voltage (open base)	$V_{CEO}$	max.	40 V
Emitter-base voltage (open collector)	$V_{EBO}$	max.	6 V
Collector current	$I_C$	max.	1 A
Total power dissipation up to $T_{amb} = 25\text{ }^\circ\text{C}$	$P_{tot}$	max.	800 mW
Total power dissipation up to $T_{case} = 25\text{ }^\circ\text{C}$	$P_{tot}$	max.	3,5 W
Storage temperature range	$T_{stg}$		-65 to 150 $^\circ\text{C}$
Junction temperature	$T_j$	max.	200 $^\circ\text{C}$

**THERMAL RESISTANCE**

From junction to case	$R_{th\ j-case}$	max.	50 K/W
From junction to ambient	$R_{th\ j-amb}$	max.	219 K/W

**CHARACTERISTICS**

$T_{amb} = 25\text{ }^\circ\text{C}$  unless otherwise specified

Collector cut-off current

$I_E = 0; V_{CB} = 50\text{ V}$	$I_{CBO}$	max.	4 $\mu\text{A}$
---------------------------------	-----------	------	-----------------

Collector-base breakdown voltage

$I_E = 0; I_C = 100\text{ }\mu\text{A}$	$V_{(BR)CBO}$	min.	65 V
---	---------------	------	------

Emitter-base breakdown voltage

$I_C = 0; I_E = 100\text{ }\mu\text{A}$	$V_{(BR)EBO}$	min.	6 V
---	---------------	------	-----

Collector-emitter sustaining voltage

$I_B = 0; I_C = 10\text{ mA}$	$V_{CEO\text{sust}}$	min.	40 V
-------------------------------	----------------------	------	------

Saturation voltages\*

$I_C = 100\text{ mA}; I_B = 10\text{ mA}$	$V_{CE\text{sat}}$	typ.	0,17 V
		max.	0,25 V

$I_C = 500\text{ mA}; I_B = 50\text{ mA}$	$V_{CE\text{sat}}$	typ.	0,36 V
		max.	0,5 V

$I_C = 1\text{ A}; I_B = 100\text{ mA}$	$V_{CE\text{sat}}$	typ.	0,6 V
		max.	0,85 V

$I_C = 100\text{ mA}; I_B = 10\text{ mA}$	$V_{BE\text{sat}}$	typ.	0,8 V
		max.	0,9 V

$I_C = 500\text{ mA}; I_B = 50\text{ mA}$	$V_{BE\text{sat}}$	max.	1,5 V
---	--------------------	------	-------

$I_C = 1\text{ A}; I_B = 100\text{ mA}$	$V_{BE\text{sat}}$	max.	2 V
---	--------------------	------	-----

\* Pulsed: pulse duration = 300  $\mu\text{s}$ ; duty cycle = 1%.

**CHARACTERISTICS** (continued)

## D.C. current gain\*

$I_C = 10 \text{ mA}; V_{CE} = 1 \text{ V}$	$h_{FE}$	min.	30
$I_C = 100 \text{ mA}; V_{CE} = 1 \text{ V}$	$h_{FE}$	min.	60
		max.	150
$I_C = 500 \text{ mA}; V_{CE} = 1 \text{ V}$	$h_{FE}$	min.	25
		typ.	60
$I_C = 1 \text{ A}; V_{CE} = 5 \text{ V}$	$h_{FE}$	min.	20
		typ.	60
$I_C = 100 \text{ mA}; V_{CE} = 1 \text{ V}; T_{amb} = -55 \text{ }^\circ\text{C}$	$h_{FE}$	min.	30
$I_C = 500 \text{ mA}; V_{CE} = 1 \text{ V}; T_{amb} = -55 \text{ }^\circ\text{C}$	$h_{FE}$	min.	15
Transition frequency at $f = 100 \text{ MHz}$			
$I_C = 50 \text{ mA}; V_{CE} = 10 \text{ V}$	$f_T$	min.	300 MHz
Emitter-base capacitance at $f = 1 \text{ MHz}$			
$I_C = 0; V_{EB} = 0,5 \text{ V}$	$C_{eb}$	max.	55 pF
Collector-base capacitance at $f = 1 \text{ MHz}$			
$I_E = 0; V_{CB} = 10 \text{ V}$	$C_{cb}$	max.	10 pF
Turn-off time			
$I_C = 500 \text{ mA}; V_{CC} = 30 \text{ V}$			
$I_{B1} = 50 \text{ mA}$	$t_{on}$	max.	35 ns
Turn-off time			
$I_C = 500 \text{ mA}; V_{CC} = 30 \text{ V}$			
$I_B = -I_{B2} = 50 \text{ mA}$	$t_{off}$	max.	60 ns

\* Pulsed: pulse duration = 300  $\mu\text{s}$ ; duty cycle = 1%.

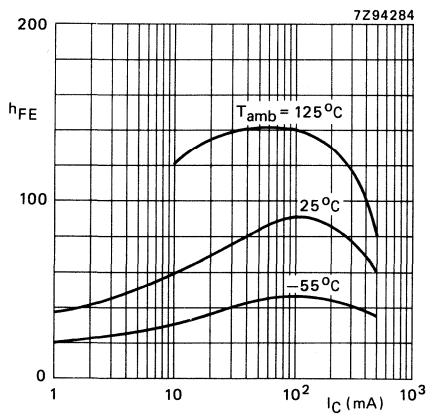

Fig. 2 D.C. current gain;  
V<sub>CE</sub> = 1 V.

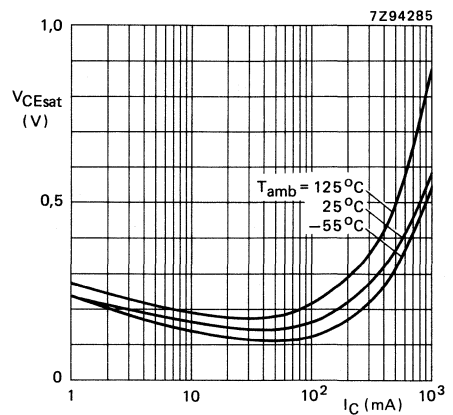

Fig. 3 Collector-emitter saturation  
voltage; I<sub>C</sub> = 10 × I<sub>B</sub>.

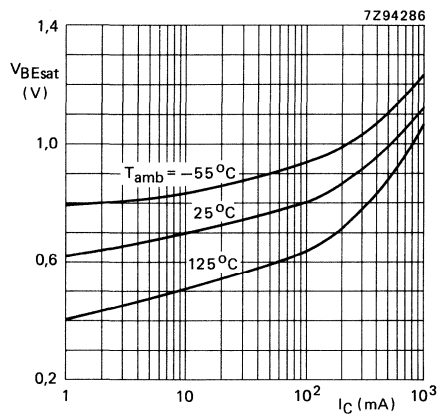

Fig. 4 Base-emitter saturation  
voltage; I<sub>C</sub> = 10 × I<sub>B</sub>.

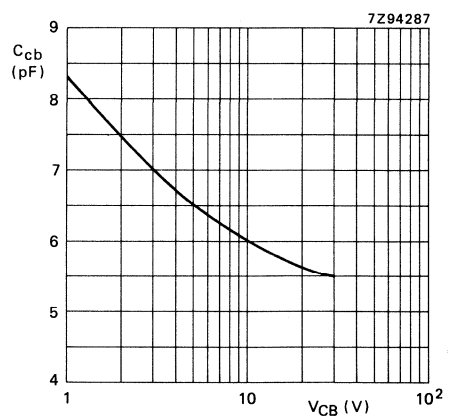

Fig. 5 Collector-base capacitance;  
I<sub>E</sub> = 0.



## SILICON PLANAR EPITAXIAL TRANSISTORS



N-P-N transistors in TO-39 metal envelopes with the collector connected to the case. These transistors are intended for general industrial applications.

## QUICK REFERENCE DATA

		BSX45	BSX46	BSX47	
Collector-emitter voltage (open base)	$V_{CEO}$ max.	40	60	80	V
Collector current (d.c.)	$I_C$ max.	1			A
Total power dissipation up to $T_{case} = 25\text{ }^\circ\text{C}$	$P_{tot}$ max.	6,25			W
Junction temperature	$T_j$ max.	200			$^\circ\text{C}$
Transition frequency at $f = 20\text{ MHz}$ $I_C = 50\text{ mA}$ ; $V_{CE} = 10\text{ V}$	$f_T >$	50			MHz
		BSX45-10 BSX46-10 BSX47-10	BSX45-16 BSX46-16		
D.C. current gain $I_C = 100\text{ mA}$ ; $V_{CE} = 1\text{ V}$	$h_{FE} >$ $h_{FE} <$	63 160		100 250	

## MECHANICAL DATA

Dimensions in mm

Fig. 1 TO-39.

Collector connected to case.

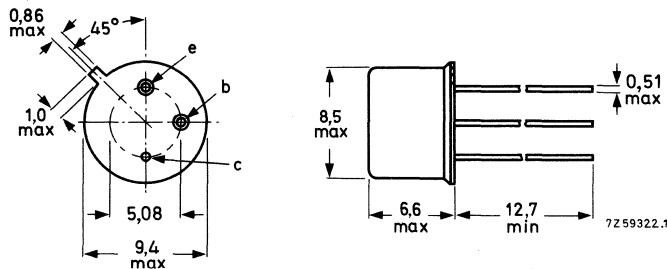

Maximum lead diameter is guaranteed only for 12,7 mm.

**RATINGS**

Limiting values in accordance with the Absolute Maximum System (IEC 134)

			BSX45	BSX46	BSX47	
Collector-emitter voltage (open base)	$V_{CEO}$	max.	40	60	80	V
Collector-emitter voltage ( $V_{BE} = 0$ )	$V_{CES}$	max.	80	100	120	V
Emitter-base voltage (open collector)	$V_{EBO}$	max.	7	7	7	V
Collector current (d.c.)	$I_C$	max.	1			A
Base current (d.c.)	$I_B$	max.	200			mA
Total power dissipation up to $T_{case} = 25\text{ }^\circ\text{C}$	$P_{tot}$	max.	6,25			W
Storage temperature range	$T_{stg}$		-65 to +150			$^\circ\text{C}$
Junction temperature	$T_j$	max.	200			$^\circ\text{C}$

**THERMAL RESISTANCE**

From junction to ambient in free air	$R_{th\ j-a}$	=	200	K/W
From junction to case	$R_{th\ j-c}$	=	28	K/W

## CHARACTERISTICS

 $T_{amb} = 25\text{ }^{\circ}\text{C}$  unless otherwise specified

		BSX45	BSX46	BSX47
Collector cut-off currents				
$V_{BE} = 0; V_{CE} = 60\text{ V}$	$I_{CES}$	< 30	30	— nA
$V_{BE} = 0; V_{CE} = 60\text{ V}; T_{amb} = 150\text{ }^{\circ}\text{C}$	$I_{CES}$	< 10	10	— $\mu\text{A}$
$V_{BE} = 0; V_{CE} = 80\text{ V}$	$I_{CES}$	< —	—	30 nA
$V_{BE} = 0; V_{CE} = 80\text{ V}; T_{amb} = 150\text{ }^{\circ}\text{C}$	$I_{CES}$	< —	—	10 $\mu\text{A}$
$V_{BE} = 0,2\text{ V}; V_{CE} = 60\text{ V}; T_{amb} = 100\text{ }^{\circ}\text{C}$	$I_{CEX}$	< 50	50	— $\mu\text{A}$
$V_{BE} = 0,2\text{ V}; V_{CE} = 80\text{ V}; T_{amb} = 100\text{ }^{\circ}\text{C}$	$I_{CEX}$	< —	—	50 $\mu\text{A}$
Emitter cut-off current				
$I_C = 0; V_{EB} = 5\text{ V}$	$I_{EBO}$	< 10	10	10 nA
Collector-emitter breakdown voltage				
open base; $I_C = 50\text{ mA}$	$V_{(BR)CEO}$	> 40	60	80 V
$V_{BE} = 0; I_C = 100\text{ }\mu\text{A}$	$V_{(BR)CES}$	> 80	100	120 V
Emitter-base breakdown voltage				
open collector; $I_E = 100\text{ }\mu\text{A}$	$V_{(BR)EBO}$	> 7	7	7 V
Base-emitter voltage				
$I_C = 100\text{ mA}; V_{CE} = 1\text{ V}$	$V_{BE}$	< 1	1	1 V
$I_C = 500\text{ mA}; V_{CE} = 1\text{ V}$	$V_{BE}$	> 0,75 < 1,50	0,75 1,50	0,75 V 1,50 V
$I_C = 1\text{ A}; V_{CE} = 1\text{ V}$	$V_{BE}$	< 2,00	2,00	2,00 V
Saturation voltage				
$I_C = 1000\text{ mA}; I_B = 100\text{ mA}$	$V_{CEsat}$	< 1,0	1,0	— V
$I_C = 500\text{ mA}; I_B = 25\text{ mA}$	$V_{CEsat}$	< —	—	0,9 V
Transition frequency at $f = 20\text{ MHz}$				
$I_C = 50\text{ mA}; V_{CE} = 10\text{ V}$	$f_T$	> 50	50	50 MHz
Collector capacitance at $f = 1\text{ MHz}$				
$I_E = I_e = 0; V_{CB} = 10\text{ V}$	$C_c$	< 25	20	15 pF
Emitter capacitance at $f = 1\text{ MHz}$				
$I_C = I_c = 0; V_{EB} = 0,5\text{ V}$	$C_e$	< 80	80	80 pF
Noise figure at $f = 1\text{ kHz}$				
$I_C = 100\text{ }\mu\text{A}; V_{CE} = 10\text{ V}$ $R_S = 1\text{ k}\Omega; B = 200\text{ Hz}$	F	typ. 3,5	3,5	3,5 dB

D.C. current gain

$I_C = 100 \mu A; V_{CE} = 1 V$

$h_{FE} >$   
typ.

$I_C = 100 mA; V_{CE} = 1 V$

$h_{FE} >$   
typ.  
 $<$

$I_C = 500 mA; V_{CE} = 1 V$

$h_{FE} >$   
typ.

$I_C = 1 A; V_{CE} = 1 V$

$h_{FE}$  typ.

BSX45-10 BSX46-10 BSX47-10	BSX45-16 BSX46-16
----------------------------------	----------------------

15	25
40	90
63	100
100	160
160	250
25	35
40	60
20	30

Switching times (see Fig. 2)

$I_{Con} = 100 mA; I_{Bon} = -I_{Boff} = 5 mA$

Turn-on time

$t_{on} <$

200

ns

Turn-off time

$t_{off} <$

850

ns

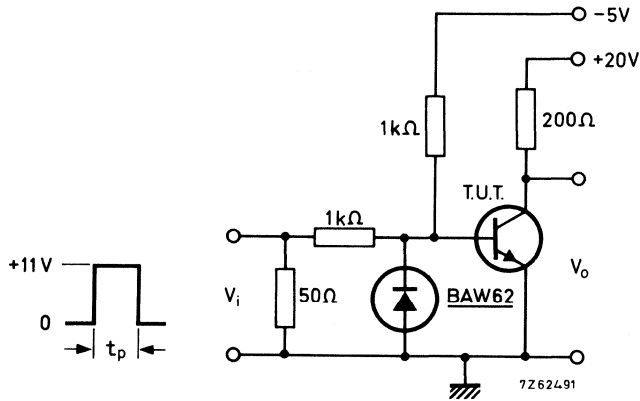

Fig. 2 Switching times test circuit.

Pulse generator:

Pulse duration	$t_p = 10 \mu s$
Rise time	$t_r \leq 15 ns$
Fall time	$t_f \leq 15 ns$
Source impedance	$Z_S = 50 \Omega$

Oscilloscope:

Rise time	$t_r \leq 15 ns$
Input impedance	$Z_I \geq 100 k\Omega$

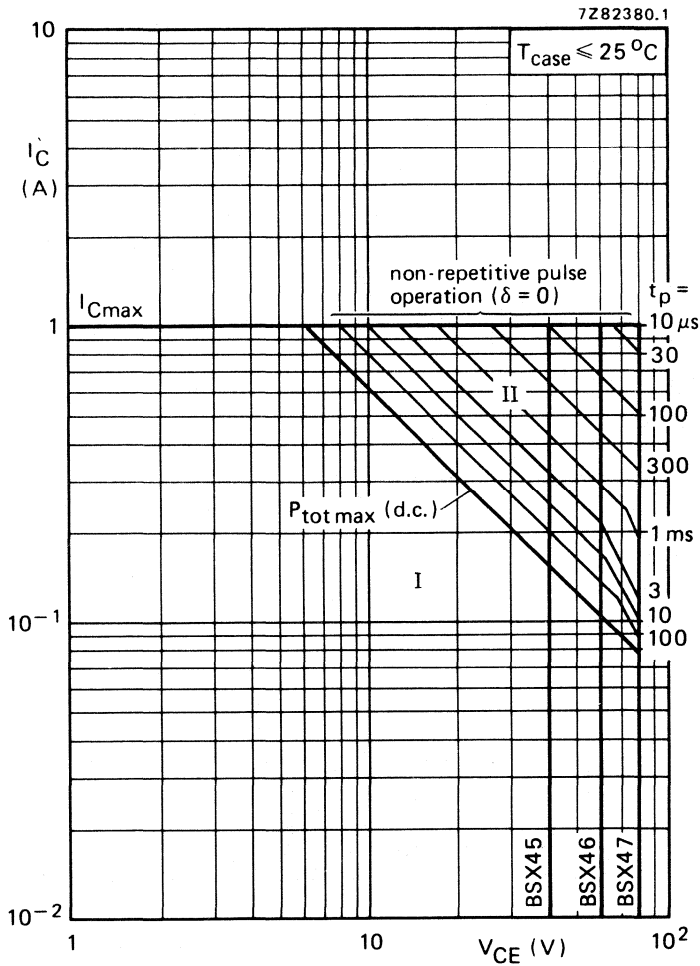

Fig. 3 Safe Operating Area;  $T_{case} \leq 25 \text{ }^\circ\text{C}^*$ .

- I Region of permissible d.c. operation.
- II Permissible extension for non-repetitive pulse operation.

\* At case temperatures  $> 25 \text{ }^\circ\text{C}$  derate constant power portion of boundaries such that:

$$P(t_p, \theta) = \frac{200 - T_{case}}{Z_{th}(t_p, \theta)}$$

(For very short forward mode pulse durations, i.e.  $t_p < 3 \mu\text{s}$ , assume 3  $\mu\text{s}$  values for  $Z_{th}$ .)

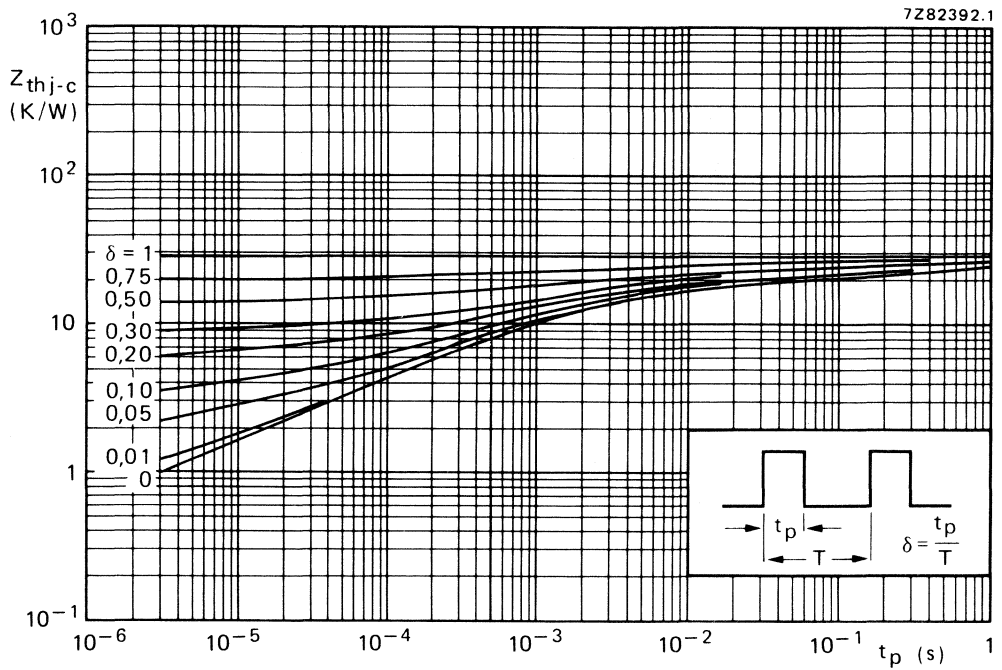

Fig. 4 Thermal impedance versus pulse duration. Stabilization time is 10 s.

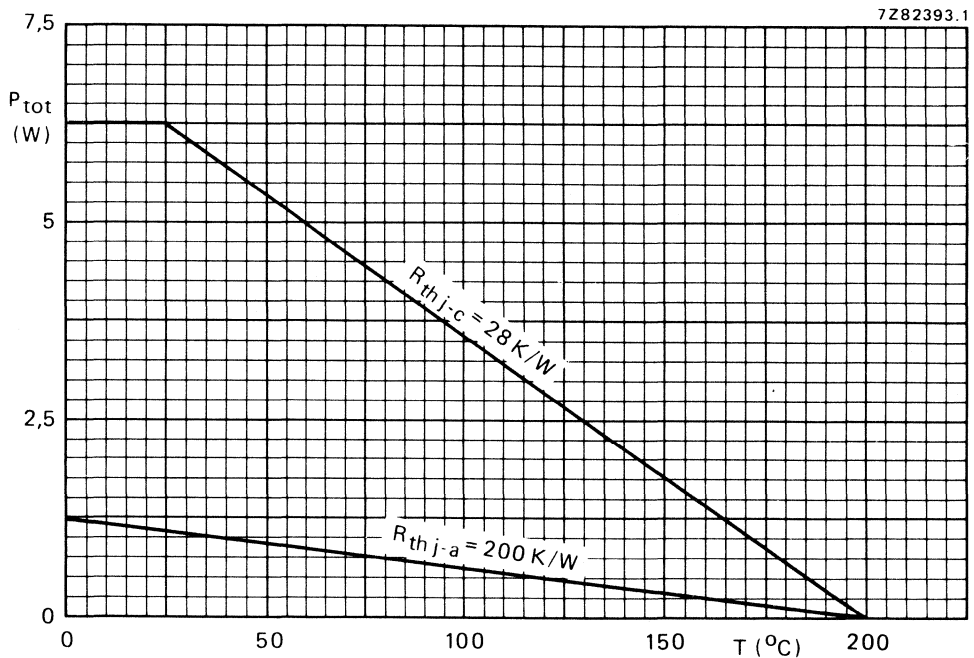

Fig. 5 Maximum permissible power dissipation as a function of temperature.

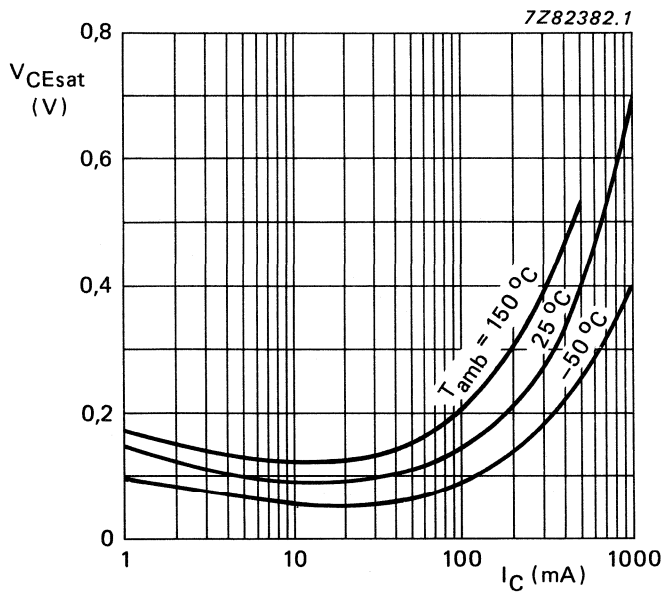

Fig. 6  $I_C/I_B = 10$ ; — typical values; at  $T_{amb} = 25\text{ }^{\circ}\text{C}$ .

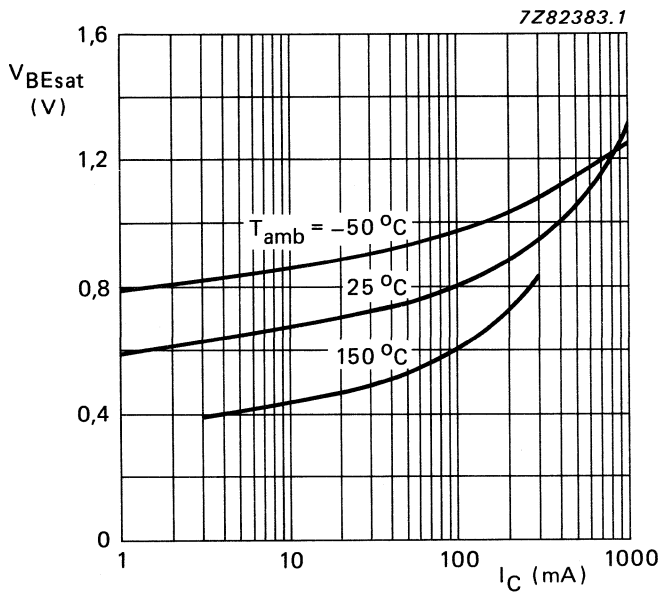

Fig. 7  $I_C/I_B = 10$ ; — typical values; at  $T_{amb} = 25\text{ }^{\circ}\text{C}$ .

7282388.1

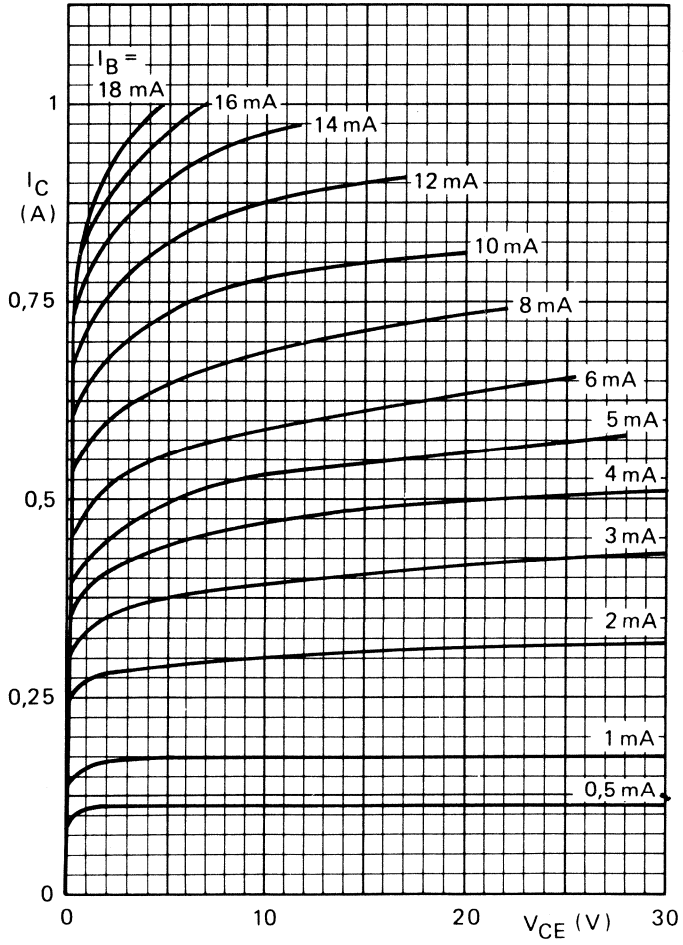

Fig. 8 Typical values;  $T_j = 25$  °C.



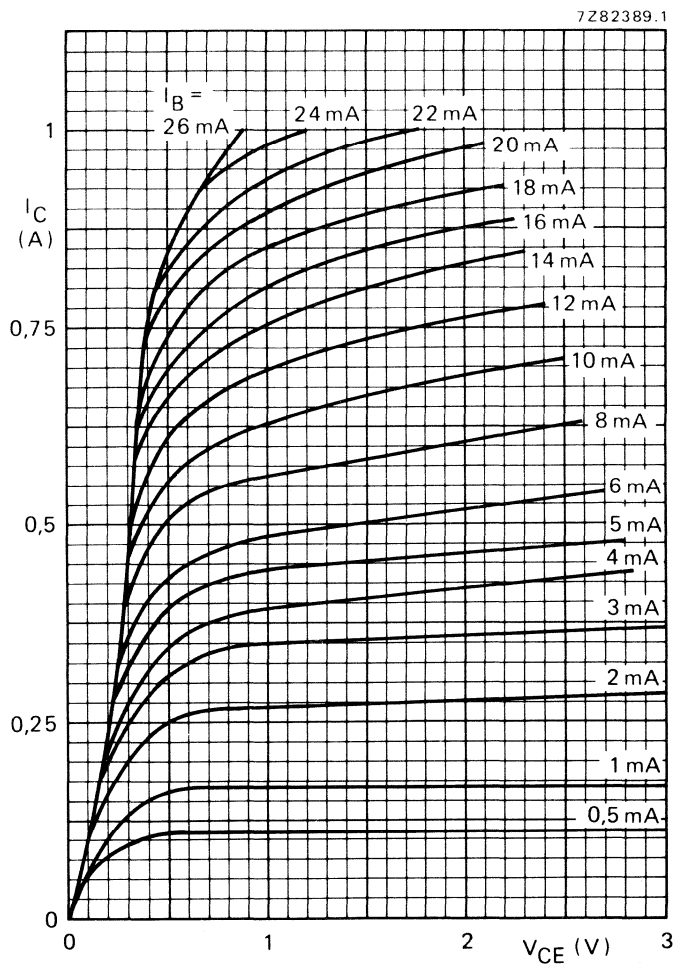

Fig. 9 Typical values;  $T_j = 25^\circ\text{C}$ .

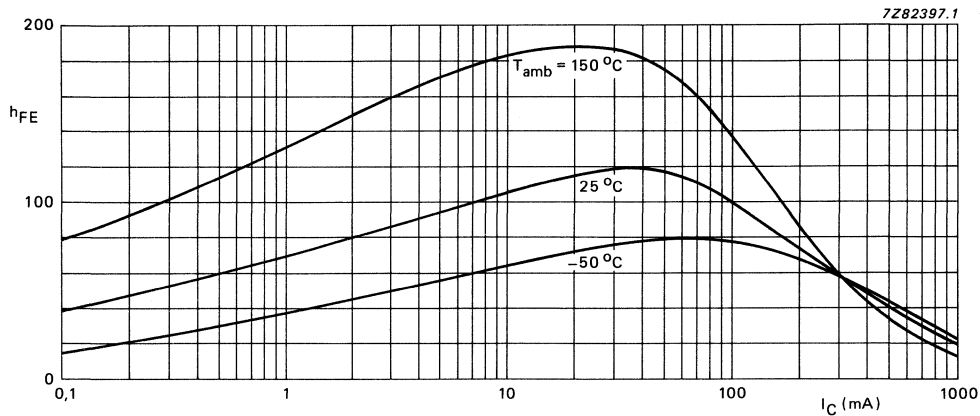

Fig. 10  $V_{CE} = 1 \text{ V}$ ; — typical values;  $T_{amb} = 25 \text{ }^\circ\text{C}$ ; Group-10.

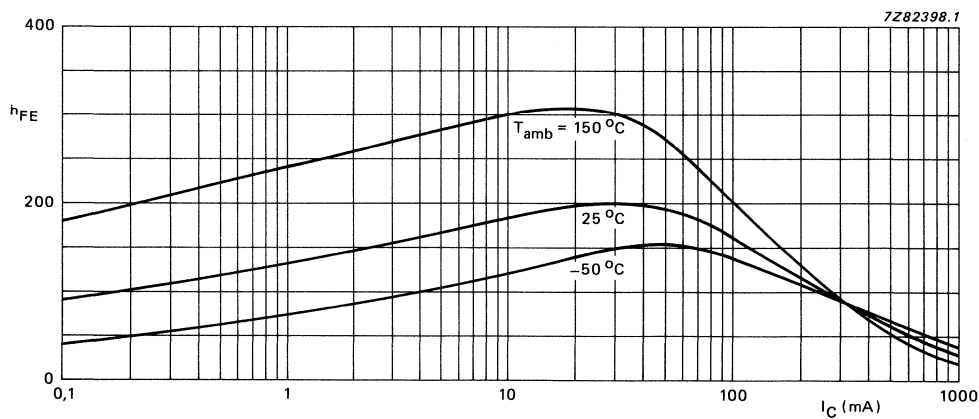

Fig. 11  $V_{CE} = 1 \text{ V}$ ; — typical values;  $T_{amb} = 25 \text{ }^\circ\text{C}$ ; Group-16.

7Z82399

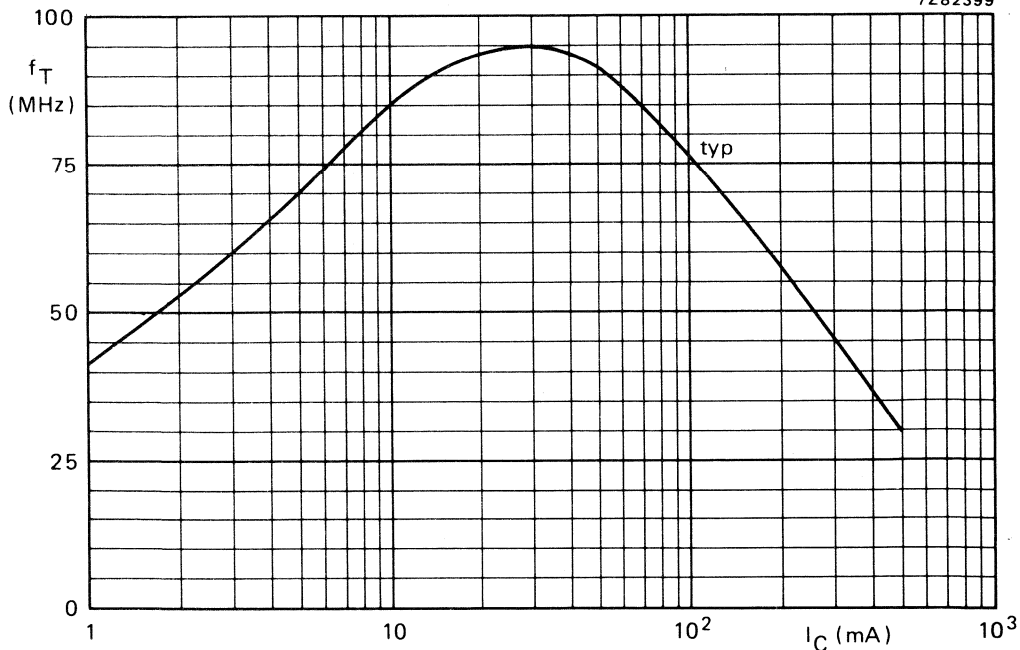

Fig. 12  $V_{CE} = 10$  V;  $f = 20$  MHz;  $T_j = 25$  °C.

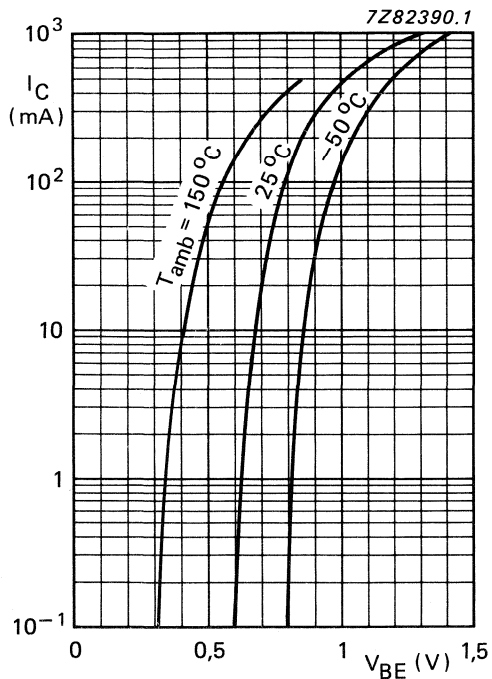

Fig. 13  $V_{CE} = 1$  V; — typical values;  $T_{amb} = 25$  °C.

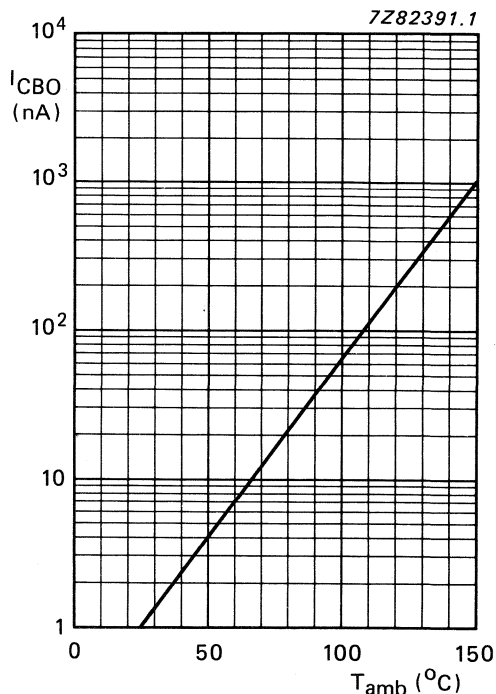

Fig. 14  $V_{CBO} = 60$  V for **BSX45** and **BSX46**;  $V_{CBO} = 80$  V for **BSX47**; typical values.



Data sheet	
status	Preliminary specification
date of issue	August 1990

# BSX49

## Silicon planar epitaxial transistor

### QUICK REFERENCE DATA

SYMBOL	PARAMETER	CONDITIONS	MIN.	MAX.	UNIT
$V_{CBO}$	collector-base voltage		-	60	V
$V_{CEO}$	collector-emitter voltage		-	40	V
$I_C$	collector current		-	600	mA
$P_{tot}$	total power dissipation	$T_{case} \leq 45^\circ C$	-	1	W
$T_j$	junction temperature		-	200	$^\circ C$
$h_{FE}$	DC current gain	$V_{CE} = 1 V$ $I_C = 100 mA$	25		
$f_T$	transition frequency	$V_{CE} = 10 V$ $I_C = 30 mA$	250	-	MHz

### MECHANICAL DATA

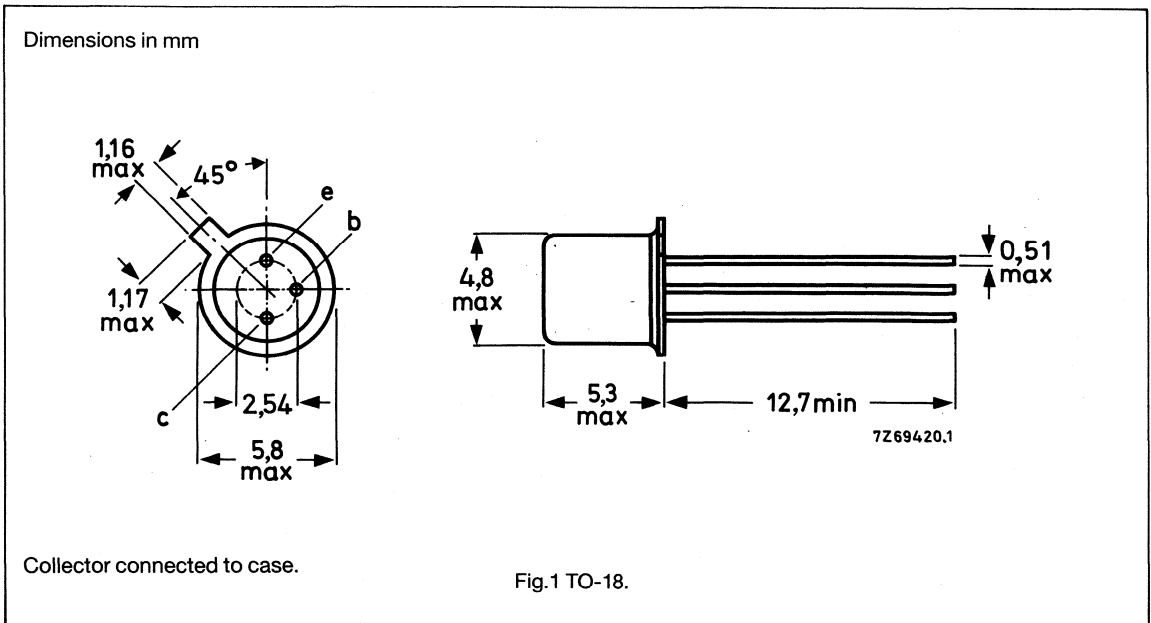

## Silicon planar epitaxial transistor

## BSX49

## LIMITING VALUES

Limiting values in accordance with the Absolute Maximum System (IEC 134).

SYMBOL	PARAMETER	CONDITIONS	MIN.	MAX.	UNIT
$V_{CBO}$	collector-base voltage	$I_E = 0$	-	60	V
$V_{CES}$	collector-emitter voltage	$V_{BE} = 0$	-	60	V
$V_{CES}$	collector-emitter voltage	$I_B = 0$	-	40	V
$V_{EBO}$	emitter-base voltage	$I_C = 0$	-	5	V
$I_C$	collector current		-	600	mA
$I_B$	base current		-	200	mA
$P_{tot}$	total power dissipation	$T_{case} \leq 45^\circ\text{C}$	-	1	W
$T_{stg}$	storage temperature range		-65	150	$^\circ\text{C}$
$T_j$	junction temperature		-	200	$^\circ\text{C}$

## THERMAL RESISTANCE

SYMBOL	PARAMETER	VALUE	UNIT
$R_{th\ j-a}$	from junction to ambient	500	K/W
$R_{th\ j-c}$	from junction to case	200	K/W

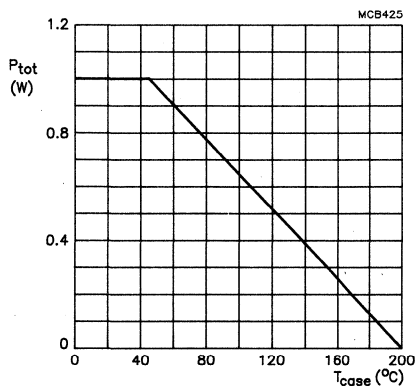

Fig.2 Total power dissipation as a function of case temperature.

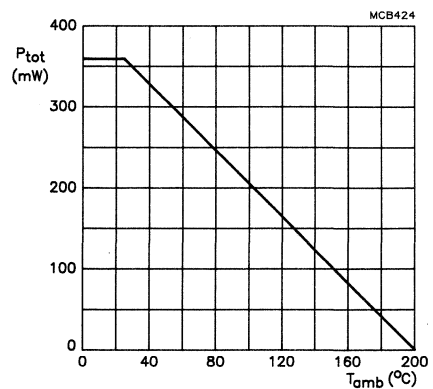

Fig.3 Total power dissipation as a function of ambient temperature.

## Silicon planar epitaxial transistor

## BSX49

## CHARACTERISTICS

$T_{amb} = 25\text{ }^{\circ}\text{C}$  unless otherwise specified.

SYMBOL	PARAMETER	CONDITIONS	MIN.	TYP.	MAX.	UNIT
$I_{CBO}$	collector cut-off current	$I_E = 0$ $V_{CB} = 50\text{ V}$	-	-	70	nA
$V_{CEsat}$	collector-emitter saturation voltage	$I_B = 10\text{ mA}$ $I_C = 100\text{ mA}$	-	170	-	mV
$V_{CEsat}$	collector-emitter saturation voltage	$I_B = 50\text{ mA}$ $I_C = 500\text{ mA}$	-	-	1	V
$V_{BEsat}$	base-emitter saturation voltage	$I_B = 10\text{ mA}$ $I_C = 100\text{ mA}$	-	0.85	-	V
$V_{BEsat}$	base-emitter saturation voltage	$I_B = 50\text{ mA}$ $I_C = 500\text{ mA}$	-	-	1.5	V
$h_{FE}$	current gain	$V_{CE} = 1\text{ V}$ $I_C = 10\text{ mA}$	-	37	-	
$h_{FE}$	current gain	$V_{CE} = 1\text{ V}$ $I_C = 100\text{ mA}$	25	-	-	
$h_{FE}$	current gain	$V_{CE} = 1\text{ V}$ $I_C = 500\text{ mA}$	10	-	-	
$f_T$	transition frequency	$V_{CE} = 10\text{ V}$ $I_C = 30\text{ mA}$ $f = 100\text{ MHz}$	250	-	-	MHz
$C_C$	collector capacitance	$V_{CB} = 10\text{ V}$ $I_E = 0$	-	-	6	pF
$C_e$	emitter capacitance	$V_{EB} = 1\text{ V}$ $I_C = 0$	-	22	-	pF
<b>Switching times</b>						
$t_{on}$	turn-on time	$I_{CX} = 150\text{ mA}$ $I_{BX} = -I_{BY} = 15\text{ mA}$	-	30	-	ns
$t_{off}$	turn-off time	$I_{CX} = 150\text{ mA}$ $I_{BX} = -I_{BY} = 15\text{ mA}$	-	50	-	ns
$t_{on}$	turn-on time	$I_{CX} = 500\text{ mA}$ $I_{BX} = 50\text{ mA}$ $-I_{BY} = 25\text{ mA}$	-	30	-	ns
$t_{off}$	turn-off time	$I_{CX} = 500\text{ mA}$ $I_{BX} = 50\text{ mA}$ $-I_{BY} = 25\text{ mA}$	-	65	-	ns





## SILICON PLANAR EPITAXIAL TRANSISTORS

N-P-N transistors in a TO-39 metal envelope with the collector connected to the case. The BSX59, BSX60 and BSX61 are primarily intended for very high speed core-driving purposes.

## QUICK REFERENCE DATA

		BSX59	BSX60	BSX61	
Collector-base voltage (open emitter)	$V_{CBO}$ max.	70	70	70	V
Collector-emitter voltage (open base)	$V_{CEO}$ max.	45	30	45	V
Collector current (peak value)	$I_{CM}$ max.	1	1	1	A
Total power dissipation up to $T_{amb} = 25\text{ }^{\circ}\text{C}$	$P_{tot}$ max.	0,8	0,8	0,8	W
Junction temperature	$T_j$ max.	200	200	200	$^{\circ}\text{C}$
D.C. current gain $I_C = 500\text{ mA}; V_{CE} = 1\text{ V}$	$h_{FE} >$	30	30	30	
Saturation voltage $I_C = 500\text{ mA}; I_B = 50\text{ mA}$	$V_{CEsat} <$	0,5	0,5	0,7	V
Transition frequency $I_C = 50\text{ mA}; V_{CE} = 10\text{ V}$	$f_T >$	250	250	250	MHz
Turn-off time $I_{Con} = 500\text{ mA}; I_{Bon} = -I_{Boff} = 50\text{ mA}$	$t_{off} <$	60	70	100	ns

## MECHANICAL DATA

Dimensions in mm

Fig. 1 TO-39.

Collector connected to case.

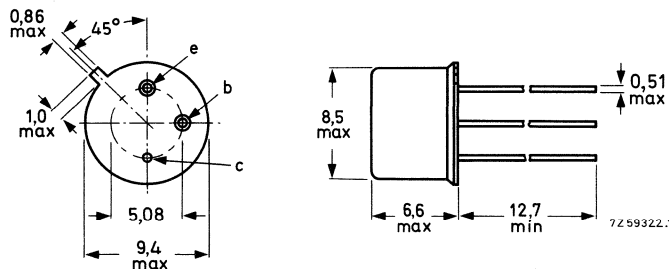

Maximum lead diameter is guaranteed only for 12,7 mm.

**RATINGS**

Limiting values in accordance with the Absolute Maximum System (IEC 134)

			BSX59	BSX60	BSX61	
Collector-base voltage (open emitter)	$V_{CBO}$	max.	70	70	70	V
Collector-emitter voltage (open base) $I_C = 10 \text{ mA}$	$V_{CEO}$	max.	45	30	45	V
Emitter-base voltage (open collector)	$V_{EBO}$	max.	5	5	5	V
Collector current (d.c.)			$I_C$	max.		1 A
Collector current (peak value)			$I_{CM}$	max.		1 A
Emitter current (peak value)			$-I_{EM}$	max.		1 A
Total power dissipation up to $T_{amb} = 25 \text{ }^\circ\text{C}$			$P_{tot}$	max.		0,8 W
Storage temperature range			$T_{stg}$			-65 to +150 $^\circ\text{C}$
Junction temperature			$T_j$	max.		200 $^\circ\text{C}$

**THERMAL RESISTANCE**

From junction to ambient in free air	$R_{th \text{ j-a}}$	=	220 K/W
From junction to case	$R_{th \text{ j-c}}$	=	43 K/W
From junction to mounting base	$R_{th \text{ j-mb}}$	=	35 K/W

## CHARACTERISTICS

 $T_j = 25\text{ }^\circ\text{C}$  unless otherwise specified

		BSX59	BSX60	BSX61	
Collector cut-off current					
$I_E = 0; V_{CB} = 40\text{ V}$	$I_{CBO}$	< 500	500	500	nA
$I_E = 0; V_{CB} = 40\text{ V}; T_j = 150\text{ }^\circ\text{C}$	$I_{CBO}$	< 300	300	300	$\mu\text{A}$
Emitter cut-off current					
$I_C = 0; V_{EB} = 4\text{ V}$	$I_{EBO}$	< 300	300	500	nA
$I_C = 0; V_{EB} = 4\text{ V}; T_j = 150\text{ }^\circ\text{C}$	$I_{EBO}$	< 50	50	50	$\mu\text{A}$
Currents at reverse biased emitter junction					
$-V_{BE} = 4\text{ V}; V_{CE} = 40\text{ V}$	$+I_{CEX}$	< 500	500	1000	nA
	$-I_{BEX}$	< 500	500	1000	nA
$-V_{BE} = 4\text{ V}; V_{CE} = 40\text{ V}; T_j = 150\text{ }^\circ\text{C}$	$+I_{CEX}$	< 300	300	500	$\mu\text{A}$
	$-I_{BEX}$	< 300	300	500	$\mu\text{A}$
Saturation voltages					
$I_C = 150\text{ mA}; I_B = 15\text{ mA}$	$V_{CEsat}$	< 0,3	0,3	0,5	V
	$V_{BEsat}$	< 1,0	1,0	1,0	V
$I_C = 500\text{ mA}; I_B = 50\text{ mA}$	$V_{CEsat}$	< 0,5	0,5	0,7	V
	$V_{BEsat}$	> 0,85	0,7	0,7	V
	$V_{BEsat}$	< 1,2	1,3	1,3	V
$I_C = 1\text{ A}; I_B = 100\text{ mA}$	$V_{CEsat}$	< 1,0	1,0	1,3	V
	$V_{BEsat}$	< 1,8	1,8	1,8	V
D.C. current gain					
$I_C = 150\text{ mA}; V_{CE} = 1\text{ V}$	$h_{FE}$	> 30	30	30	
$I_C = 500\text{ mA}; V_{CE} = 1\text{ V}$	$h_{FE}$	> 30	30	30	
	$h_{FE}$	< 90	90	90	
$I_C = 1\text{ A}; V_{CE} = 5\text{ V}$	$h_{FE}$	> 20	25	20	
Transition frequency					
$I_C = 50\text{ mA}; V_{CE} = 10\text{ V}$	$f_T$	> 250	250	250	MHz
Collector capacitance at $f = 1\text{ MHz}$					
$I_E = I_e = 0; V_{CB} = 10\text{ V}$	$C_c$	typ. 6	6	6	pF
	$C_c$	< 10	10	10	pF
Emitter capacitance at $f = 1\text{ MHz}$					
$I_C = I_c = 0; V_{EB} = 0,5\text{ V}$	$C_e$	typ. 36	36	36	pF
	$C_e$	< 50	50	50	pF

**CHARACTERISTICS**

$T_j = 25\text{ }^\circ\text{C}$  unless otherwise specified

Recovered charge

$I_C = 500\text{ mA}; I_B = 50\text{ mA}$

**BSX60**  $Q_S < 5\text{ nC}$

Test circuit:

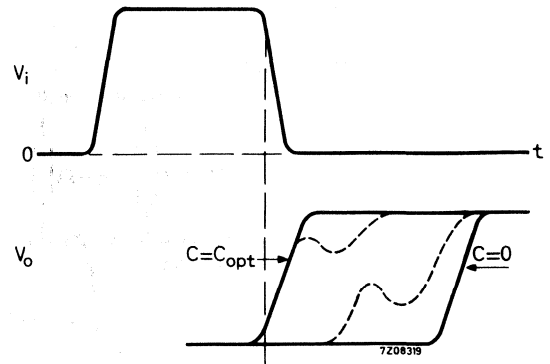
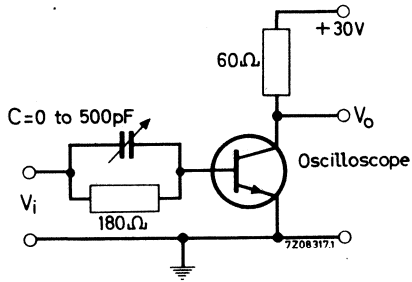

Adjust C from zero to  $C_{opt}$

$$Q_S = C_{opt} \cdot V_i$$

Pulse generator:

Pulse duration  $t_p = 10\text{ }\mu\text{s}$

Duty cycle  $\delta = 0,02$

Switching times (see also Figs 4, 11 and 12)

Turn-on time when switched from  
 $-V_{BE} = 2\text{ V}$  to  $I_{Con} = 500\text{ mA}$ ;  $I_{Bon} = 50\text{ mA}$

$t_{on}$  typ. <

	BSX59	BSX60	BSX61
$t_{on}$ typ. <	17	17	18 ns
	35	40	50 ns
$t_{off}$ typ. <	45	58	70 ns
	60	70	100 ns

Turn-off time when switched from  
 $I_{Con} = 500\text{ mA}$ ;  $I_{Bon} = 50\text{ mA}$  to cut-off with  
 $-I_{Boff} = 50\text{ mA}^*$

$t_{off}$  typ. <

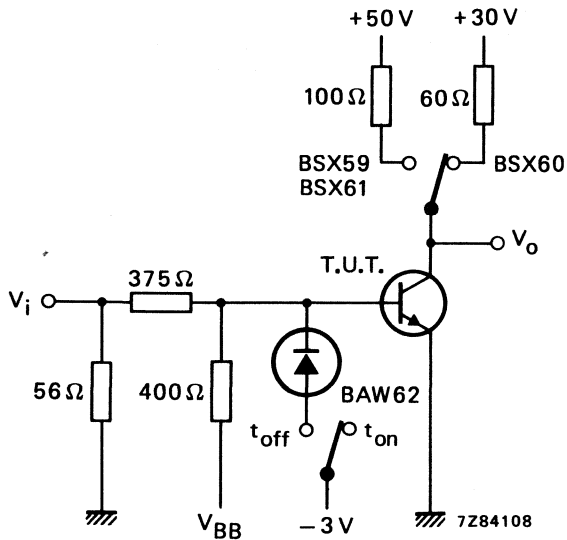

	$t_{on}$	$t_{off}$
$-V_{BB}$	4	16,7 V
$V_i$	24,75	37,5 V

Fig. 4 Switching circuit.

Pulse generator:

- Pulse duration  $t_p \geq 500\text{ ns}$
- Rise time  $t_r \leq 5\text{ ns}$
- Fall time  $t_f \leq 5\text{ ns}$
- Output resistance  $R_o = 50\ \Omega$  (during pulse, otherwise infinite)

\*  $-I_{Boff}$  is the reverse current that can flow during switching off. The indicated  $-I_{Boff}$  is determined and limited by the applied cut-off voltage and the series resistance.

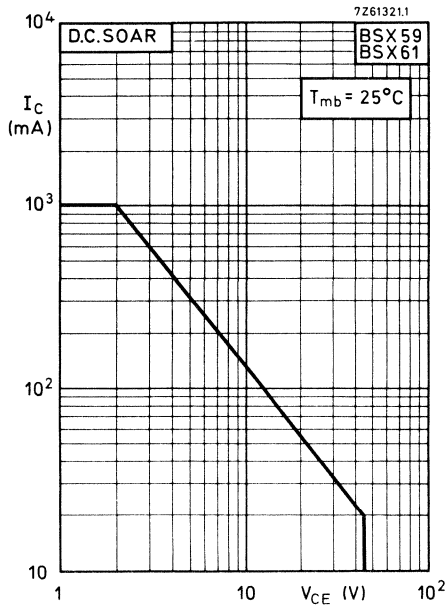

Fig. 5.

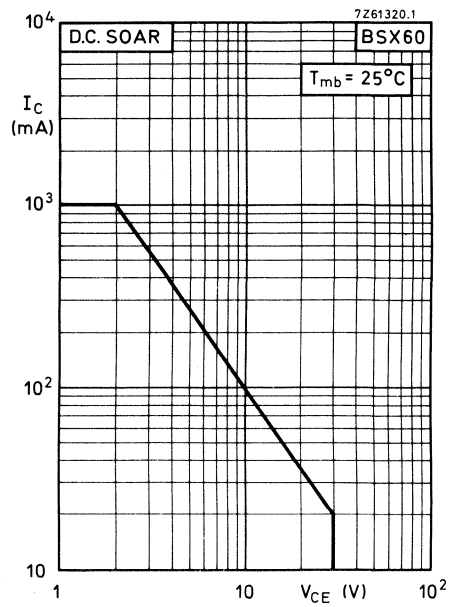

Fig. 6.

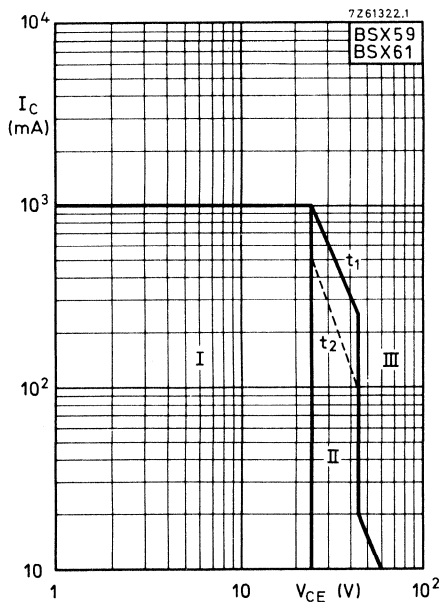

Fig. 7.

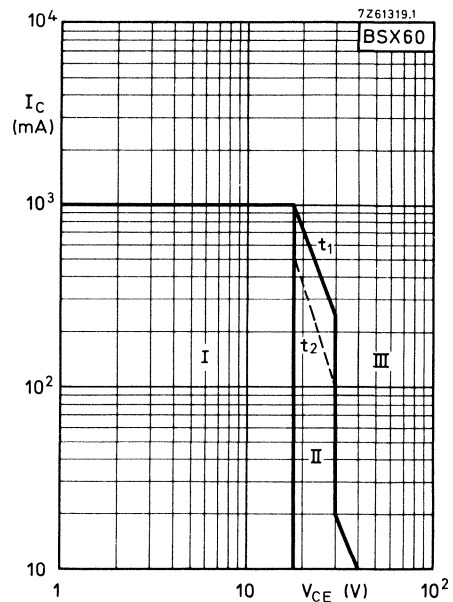

Fig. 8.

- I Region of permissible operation during switching off with  $-V_{BB} = 4 \text{ V}$ ;  $R_{BE} = 39 \Omega$ .
- II Permissible extension for repetitive pulsed operation.  
 $t_1$  limits operations with  $t_p \leq 0,1 \mu\text{s}$ ;  $\delta = 0,25$   
 $t_2$  limits operations with  $t_p \leq 1 \mu\text{s}$ ;  $\delta = 0,25$
- III Operation in this area is not allowed.

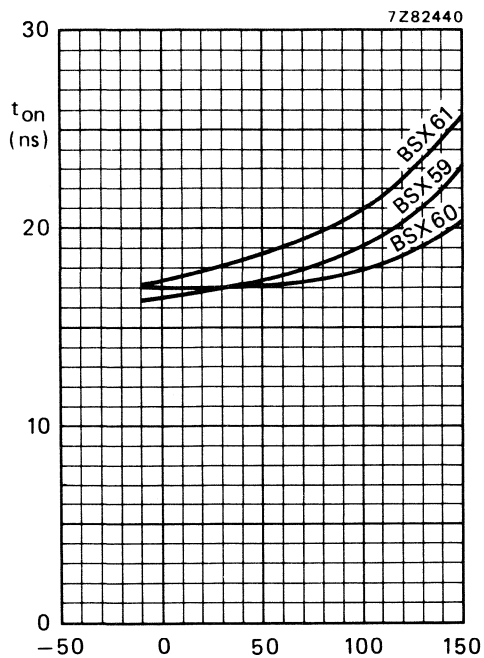

Fig. 9  $-V_{BEoff} = 2\text{ V}$ ;  $I_{Con} = 500\text{ mA}$ ;  $I_{Bon} = 50\text{ mA}$ ; typ. values. (See also Fig. 4).

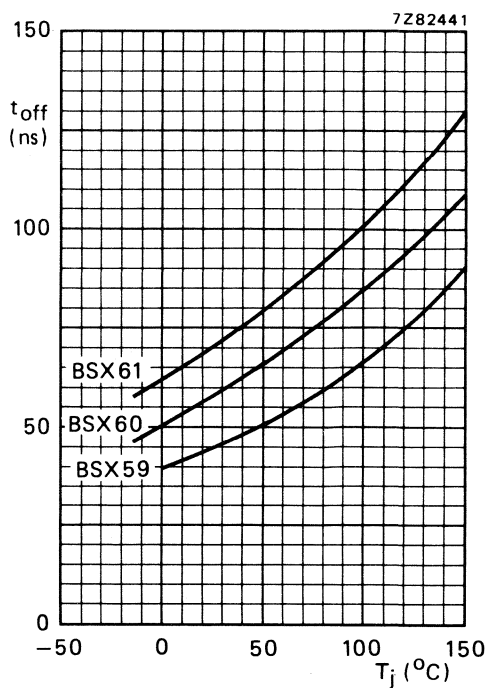

Fig. 10  $I_{Con} = 500\text{ mA}$ ;  $I_{Bon} = -I_{Boff} = 50\text{ mA}$ ; typical values. (See also Fig. 4).

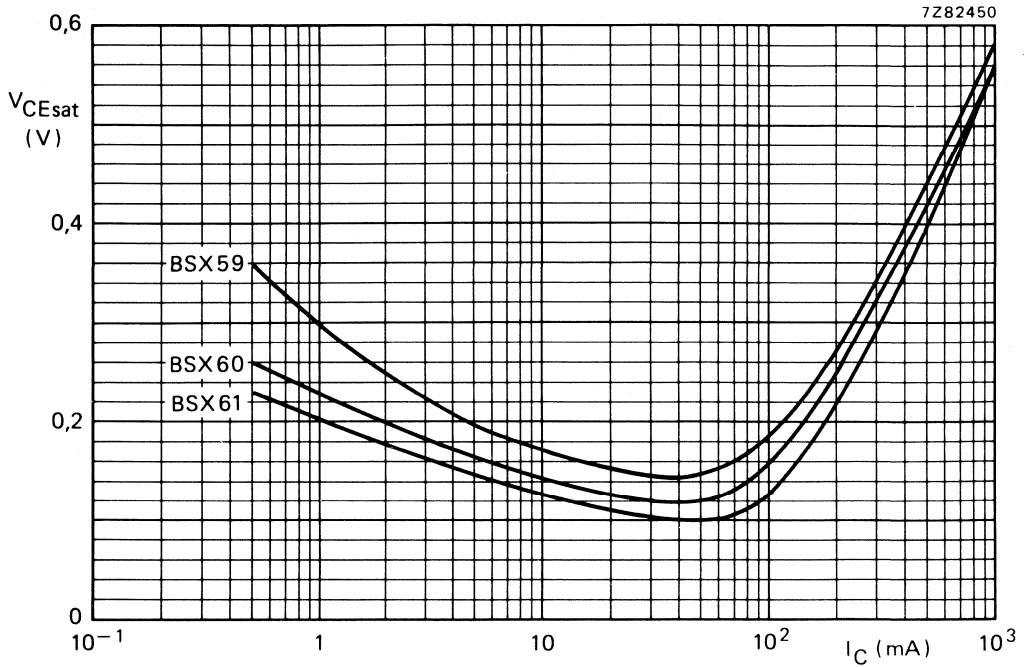

Fig. 11  $I_C/I_B = 10$ ;  $T_j = 25^\circ\text{C}$ ; typical values.

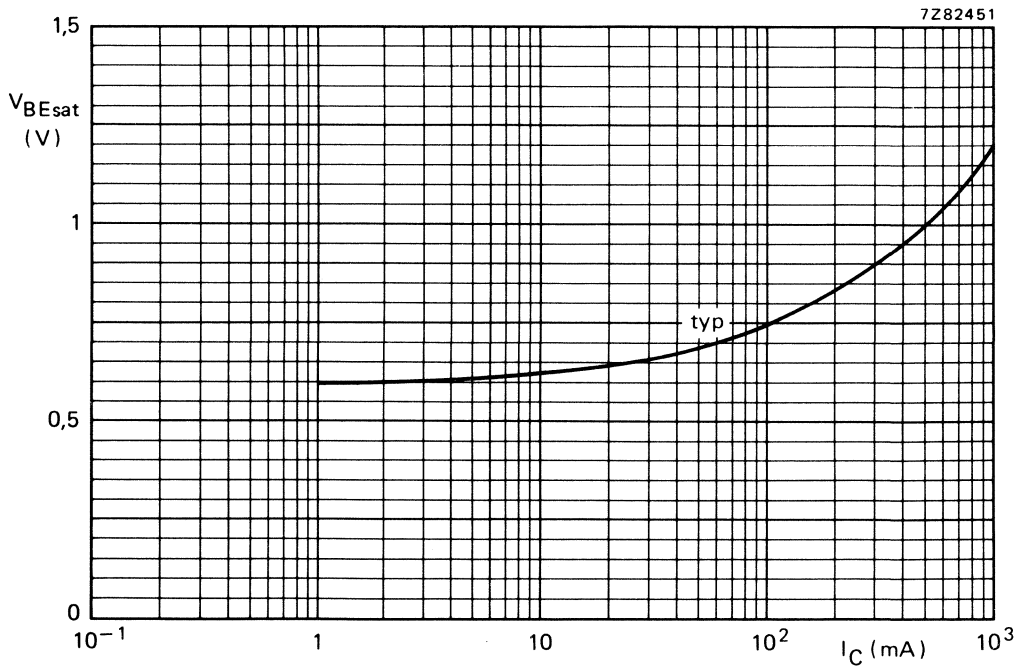

Fig. 12  $I_C/I_B = 10$ ;  $T_j = 25^\circ\text{C}$ .



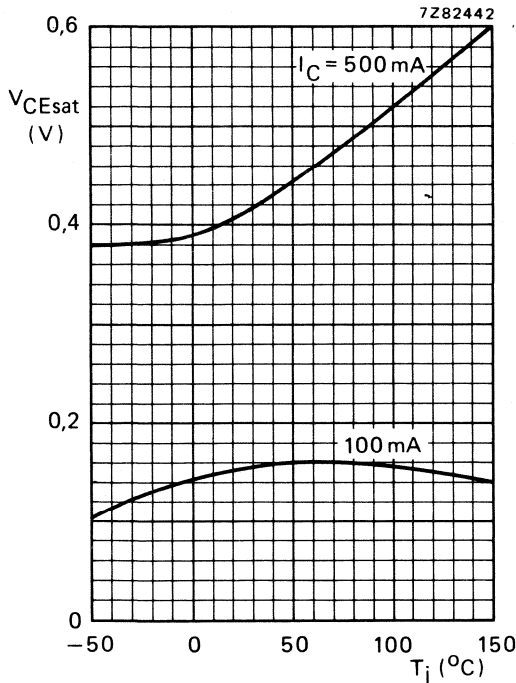

Fig. 13  $I_C/I_B = 10$ ; typical values.

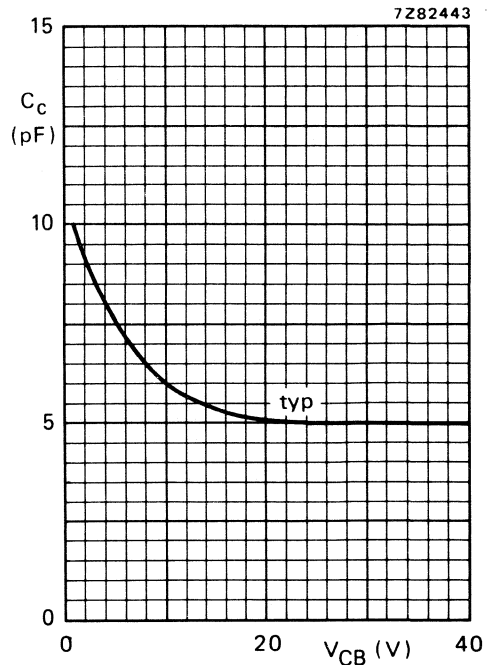

Fig. 14  $I_E = I_e = 0$ ;  $f = 1$  MHz;  $T_j = 25$  °C.

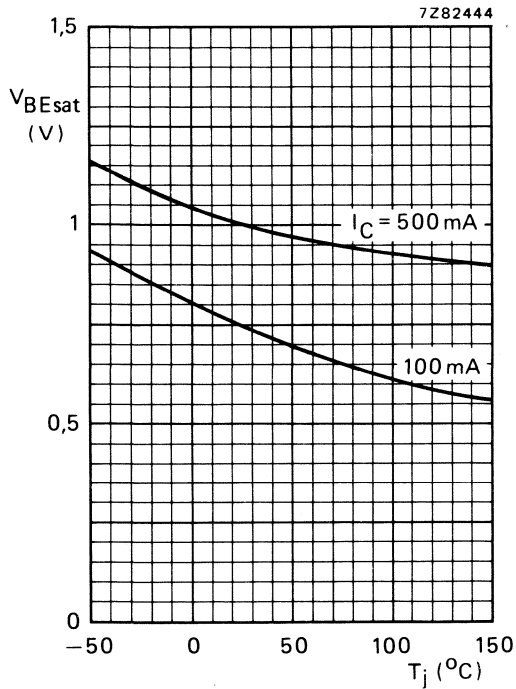

Fig. 15  $I_C/I_B = 10$ ; typical values.

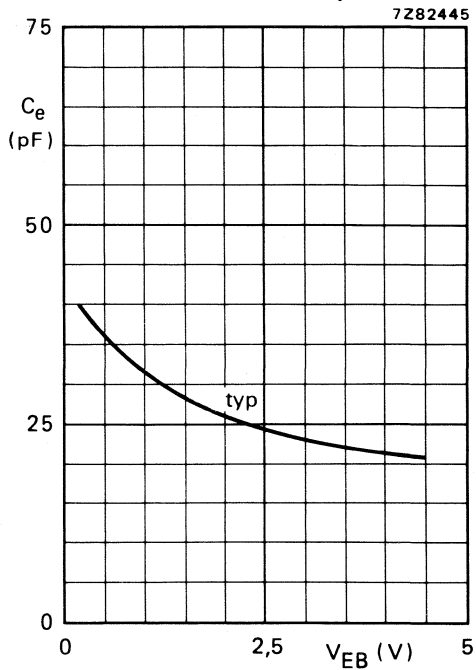

Fig. 16  $I_C = I_c = 0$ ;  $f = 1$  MHz;  $T_j = 25$  °C.

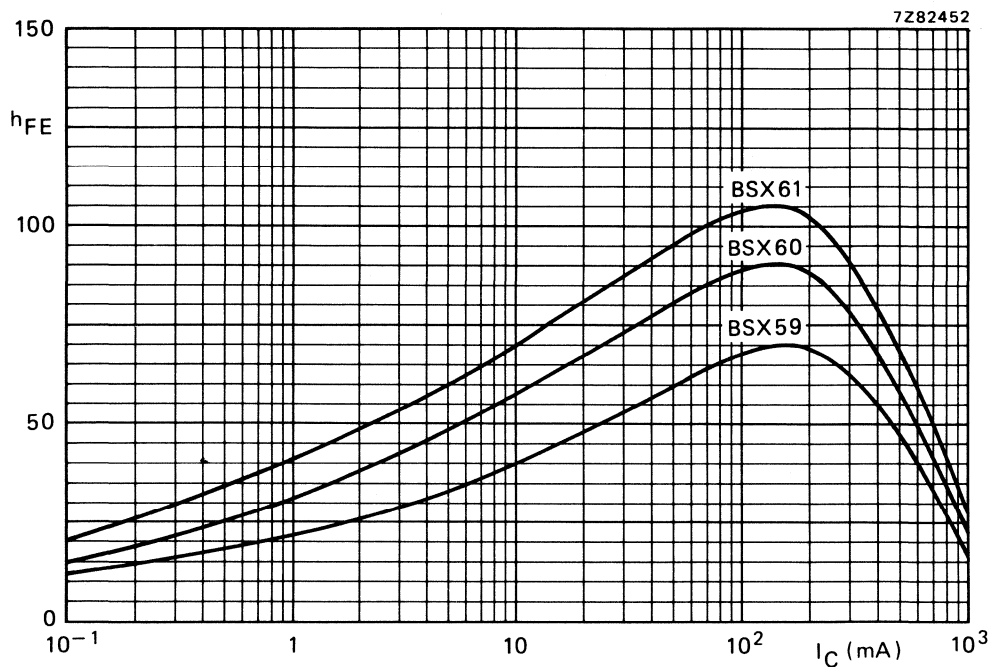

Fig. 17  $V_{CE} = 1\text{ V}$ ;  $T_j = 25\text{ }^\circ\text{C}$ ; typical values.

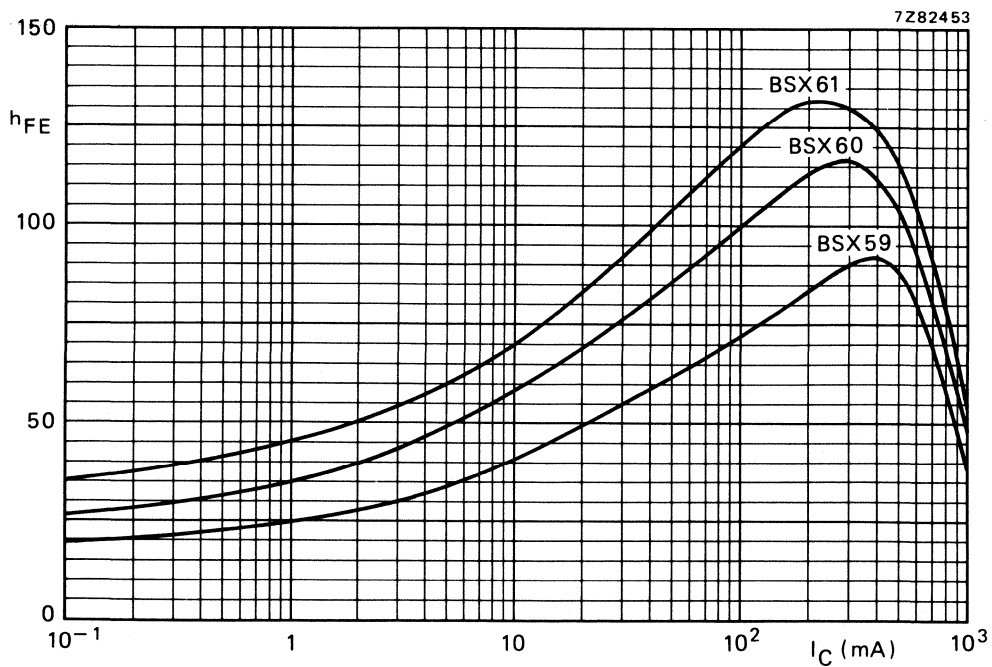

Fig. 18  $V_{CE} = 5\text{ V}$ ;  $T_j = 25\text{ }^\circ\text{C}$ ; typical values.

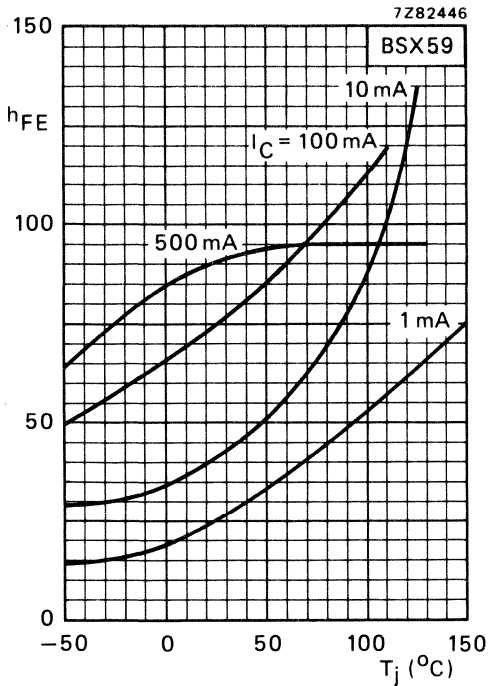

Fig. 19  $V_{CE} = 5 \text{ V}$ ; typical values.

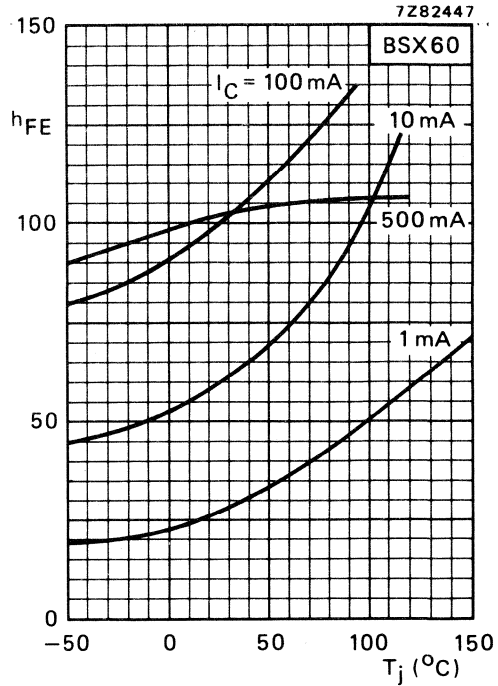

Fig. 20  $V_{CE} = 5 \text{ V}$ ; typical values.

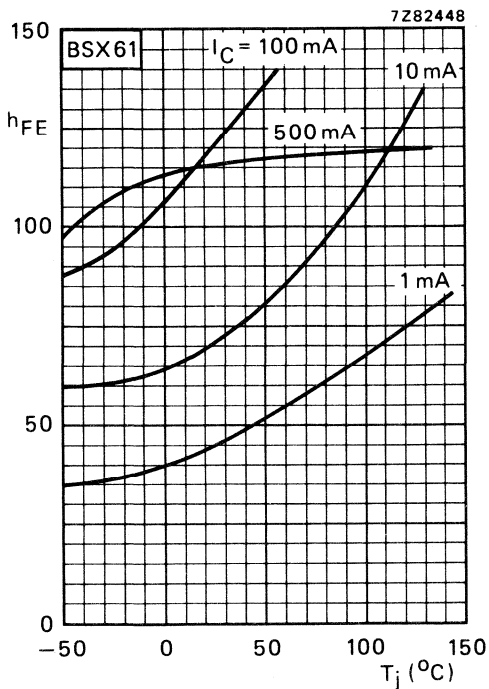

Fig. 21  $V_{CE} = 5 \text{ V}$ ; typical values.

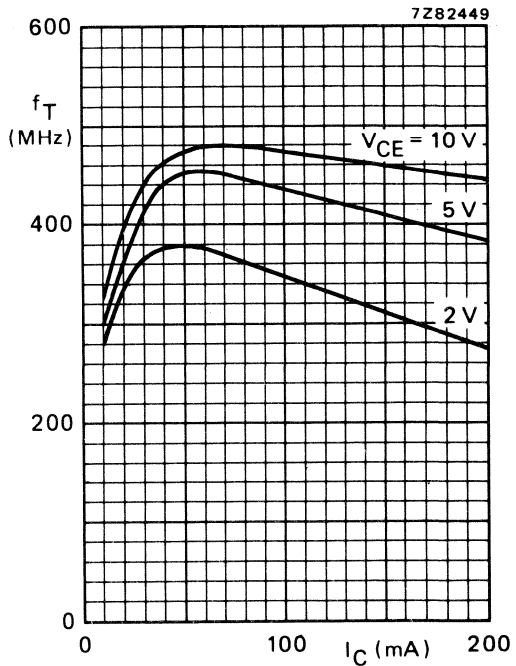

Fig. 22  $f = 100 \text{ MHz}$ ;  $T_j = 25 \text{ °C}$ ; typ. values.



Data sheet	
status	Preliminary specification
date of issue	June 1992

# BSX62-10, -16/BSX63-10, -16

## Silicon planar epitaxial transistors

### QUICK REFERENCE DATA

SYMBOL	PARAMETER	CONDITIONS	MIN.	TYP.	MAX.	UNIT	
$V_{CE0}$	collector-emitter voltage	BSX62	-	-	40	V	
		BSX63	-	-	60	V	
$I_C$	collector current		-	-	3	A	
$P_{tot}$	total power dissipation	$T_{amb} = 25\text{ }^\circ\text{C}$	-	-	875	mW	
$P_{tot}$	total power dissipation	$T_{case} = 25\text{ }^\circ\text{C}$	-	-	5	W	
$T_j$	junction temperature		-	-	200	$^\circ\text{C}$	
$h_{FE}$	DC current gain	$V_{CE} = 1\text{ V}$ $I_C = 1\text{ A}$	BSX62-10	63	-	160	
			BSX63-10				
			BSX62-16	100	-	250	
$f_T$	transition frequency	$V_{CE} = 10\text{ V}$ $I_C = 200\text{ mA}$	-	70	-	MHz	

### MECHANICAL DATA

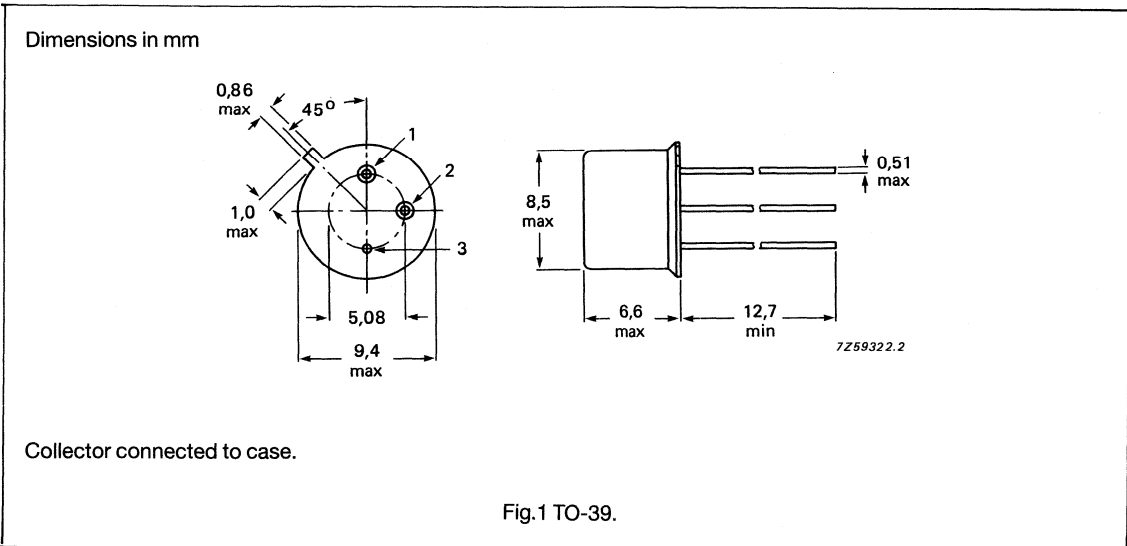

Silicon planar epitaxial transistors

BSX62-10, -16/BSX63-10, -16

**LIMITING VALUES**

Limiting values in accordance with the Absolute Maximum System (IEC 134),

SYMBOL	PARAMETER	CONDITIONS	MIN.	MAX.	UNIT
$V_{CES}$	collector-emitter voltage	$V_{BE} = 0$	-	60	V
		BSX62	-	80	V
		BSX63	-	80	V
$V_{CEO}$	collector-emitter voltage	$I_B = 0$	-	40	V
		BSX62	-	60	V
		BSX63	-	60	V
$V_{EBO}$	emitter-base voltage	$I_C = 0$	-	5	V
$I_C$	collector current		-	3	A
$I_B$	base current		-	500	mA
$P_{tot}$	total power dissipation	$T_{case} \leq 25\text{ }^\circ\text{C}$	-	5	W
$T_j$	junction temperature		-	200	$^\circ\text{C}$
$T_{stg}$	storage temperature range		-65	150	$^\circ\text{C}$

**THERMAL RESISTANCE**

SYMBOL	PARAMETER	VALUE	UNIT
$R_{th\ j-a}$	from junction to ambient	200	K/W
$R_{th\ j-c}$	from junction to case	28	K/W

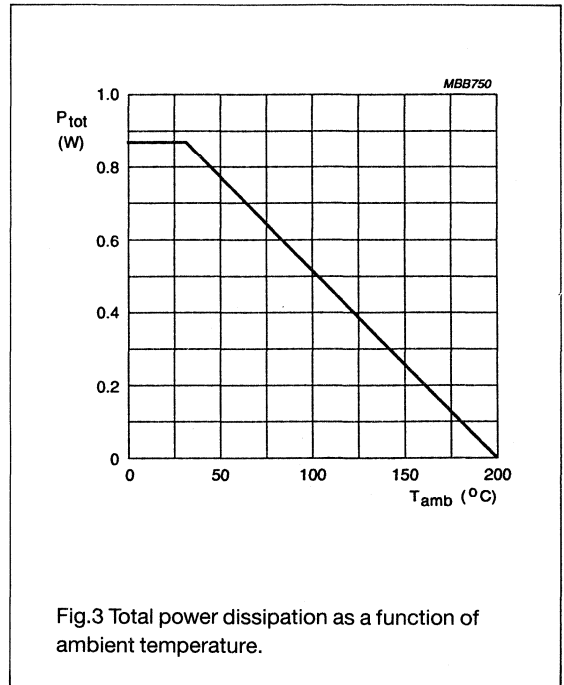
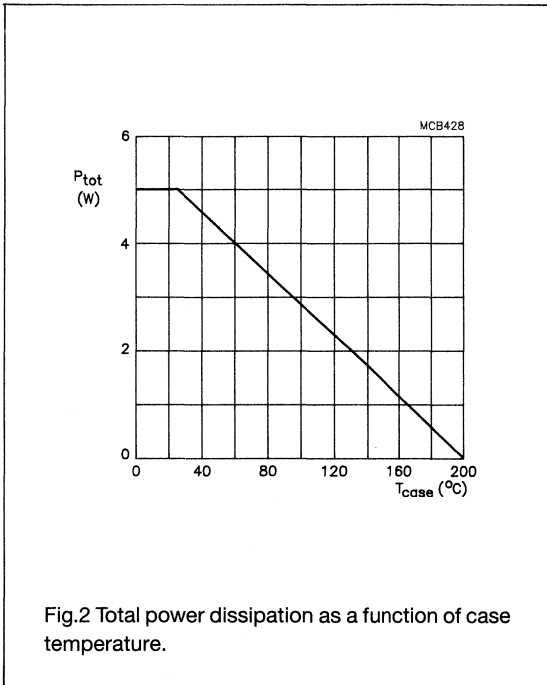

## Silicon planar epitaxial transistors

## BSX62-10, -16/BSX63-10, -16

## CHARACTERISTICS

$T_{\text{case}} = 25\text{ }^{\circ}\text{C}$  unless otherwise specified.

SYMBOL	PARAMETER	CONDITIONS	MIN.	TYP.	MAX.	UNIT	
$I_{\text{CES}}$	collector-emitter cut-off current	$V_{\text{BE}} = 0$ $V_{\text{CE}} = 40\text{ V}$	BSX62	-	-	100	nA
$I_{\text{CES}}$	collector-emitter cut-off current	$V_{\text{BE}} = 0$ $V_{\text{CE}} = 40\text{ V}$ $T_{\text{case}} = 150\text{ }^{\circ}\text{C}$	BSX62	-	-	100	$\mu\text{A}$
$I_{\text{CES}}$	collector-emitter cut-off current	$V_{\text{BE}} = 0$ $V_{\text{CE}} = 60\text{ V}$	BSX63	-	-	100	nA
$I_{\text{CES}}$	collector-emitter cut-off current	$V_{\text{BE}} = 0$ $V_{\text{CE}} = 60\text{ V}$ $T_{\text{case}} = 150\text{ }^{\circ}\text{C}$	BSX63	-	-	100	$\mu\text{A}$
$V_{(\text{BR})\text{CBO}}$	collector-base breakdown voltage	$I_{\text{E}} = 0$ $I_{\text{C}} = 100\text{ }\mu\text{A}$	BSX62 BSX63	60 80	- -	- -	V V
$V_{(\text{BR})\text{CEO}}$	collector-emitter breakdown voltage	$I_{\text{B}} = 0$ $I_{\text{C}} = 100\text{ mA}$	BSX62 BSX63	40 60	- -	- -	V V
$V_{(\text{BR})\text{EBO}}$	emitter-base breakdown voltage	$I_{\text{E}} = 10\text{ }\mu\text{A}$ $I_{\text{C}} = 0$		5	-	-	V
$V_{\text{CEsat}}$	collector-emitter saturation voltage	$I_{\text{B}} = 100\text{ mA}$ $I_{\text{C}} = 1\text{ A}$		-	-	0.7	V
$V_{\text{CEsat}}$	collector-emitter saturation voltage	$I_{\text{B}} = 200\text{ mA}$ $I_{\text{C}} = 2\text{ A}$		-	-	0.8	V
$V_{\text{BEsat}}$	base-emitter saturation voltage	$I_{\text{B}} = 100\text{ mA}$ $I_{\text{C}} = 1\text{ A}$		-	-	1.2	V
$V_{\text{BEsat}}$	base-emitter saturation voltage	$I_{\text{B}} = 200\text{ mA}$ $I_{\text{C}} = 2\text{ A}$		-	-	1.3	V
$V_{\text{BE}}$	base-emitter voltage	$V_{\text{CE}} = 1\text{ V}$ $I_{\text{C}} = 100\text{ mA}$		-	-	1	V
$V_{\text{BE}}$	base-emitter voltage	$V_{\text{CE}} = 1\text{ V}$ $I_{\text{C}} = 1\text{ A}$		-	-	1.2	V
$V_{\text{BE}}$	base-emitter voltage	$V_{\text{CE}} = 5\text{ V}$ $I_{\text{C}} = 2\text{ A}$		-	-	1.3	V
$f_{\text{T}}$	transition frequency	$V_{\text{CE}} = 10\text{ V}$ $I_{\text{C}} = 200\text{ mA}$		30	-	-	MHz
$C_{\text{c}}$	collector capacitance	$V_{\text{CB}} = 10\text{ V}$ $I_{\text{E}} = 0$		-	-	70	pF

Silicon planar epitaxial transistors

BSX62-10, -16/BSX63-10, -16

SYMBOL	PARAMETER	CONDITIONS	MIN.	TYP.	MAX.	UNIT
<b>Switching times</b>						
t <sub>on</sub>	turn-on time	I <sub>CX</sub> ≈ 1 A I <sub>BX</sub> = -I <sub>BY</sub> ≈ 50 mA	-	-	0.3	μs
t <sub>off</sub>	turn-off time	I <sub>CX</sub> ≈ 1 A I <sub>BX</sub> = -I <sub>BY</sub> ≈ 50 mA	-	-	1.5	μs
h <sub>FE</sub>	DC current gain	V <sub>CE</sub> = 1 V I <sub>C</sub> = 100 mA		110	-	
				180	-	
h <sub>FE</sub>	DC current gain	V <sub>CE</sub> = 1 V I <sub>C</sub> = 1 A	63	100	160	
			100	160	250	
h <sub>FE</sub>	DC current gain	V <sub>CE</sub> = 5 V I <sub>C</sub> = 2 A		70	-	
				120	-	

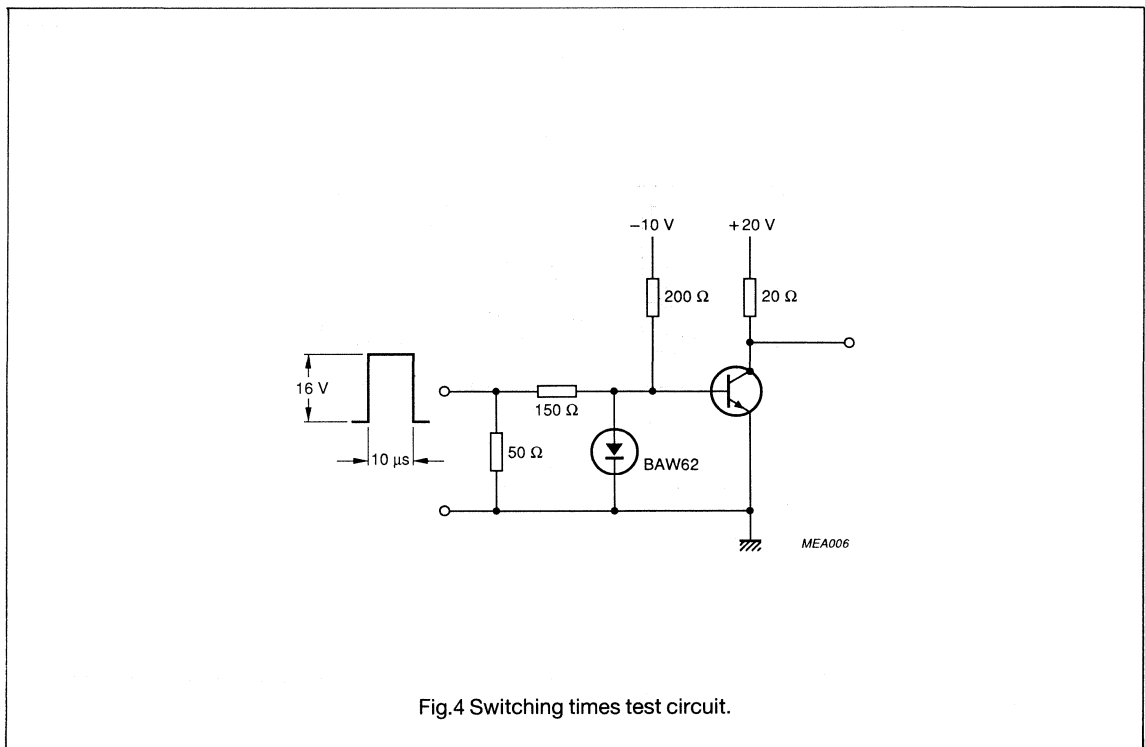

Fig.4 Switching times test circuit.



Silicon planar epitaxial transistors

BSX62-10, -16/BSX63-10, -16

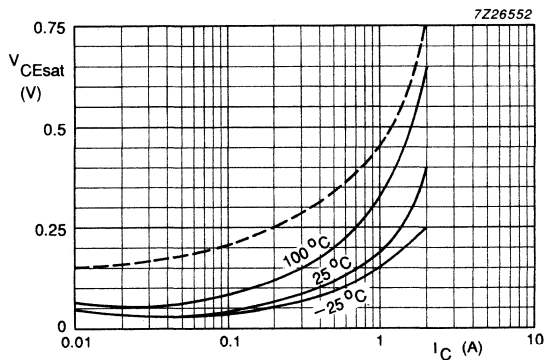

Fig.5 Collector-emitter saturation voltage as a function of collector current;  $I_C:I_B = 10$ ; - typical values at  $T_{amb}$ ; --- maximum values at  $T_{case} = 25$  °C.

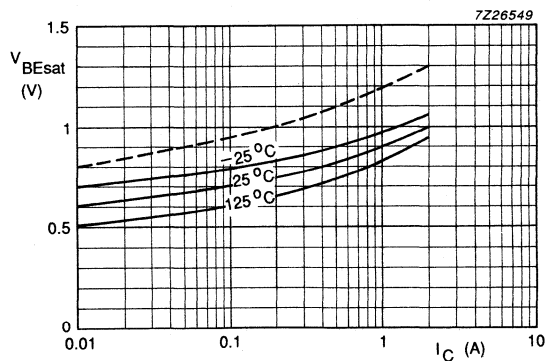

Fig.6 Base-emitter saturation voltage as a function of collector current;  $I_C:I_B = 10$ ; - typical values at  $T_{amb}$ ; --- maximum values at  $T_{case} = 25$  °C.

Silicon planar epitaxial transistors

BSX62-10, -16/BSX63-10, -16

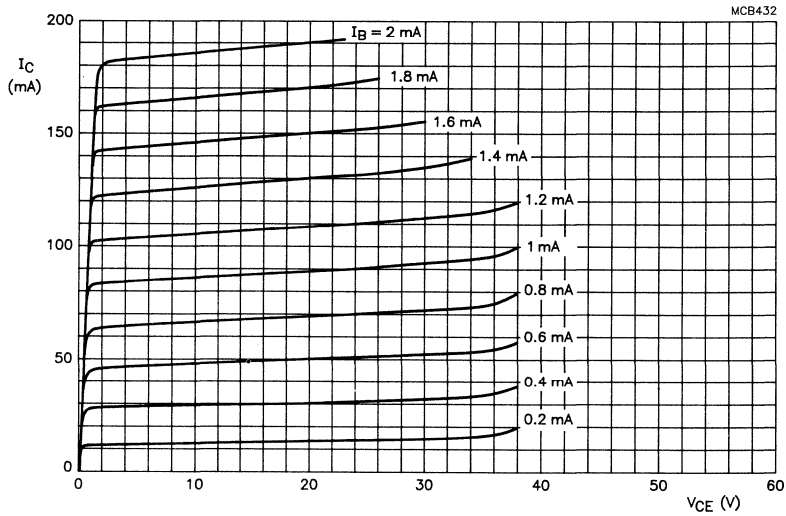

Fig.7 Collector current as a function of collector-emitter voltage; BSX62.

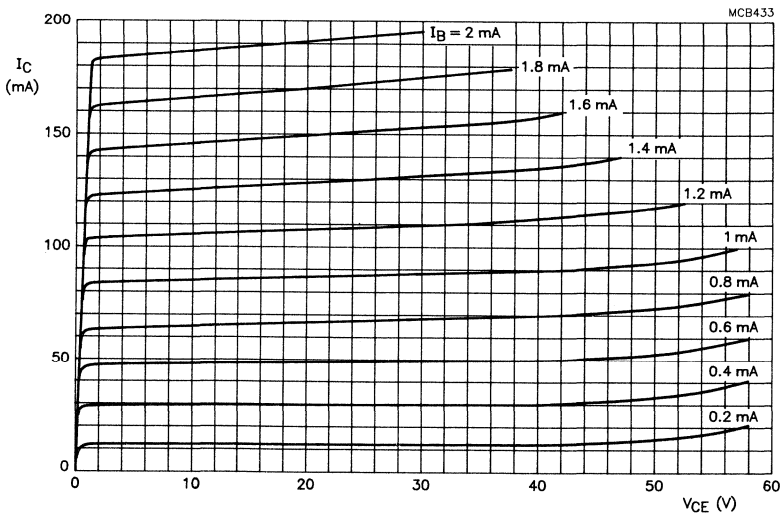

Fig.8 Collector current as a function of collector-emitter voltage; BSX63.

Silicon planar epitaxial transistors

BSX62-10, -16/BSX63-10, -16

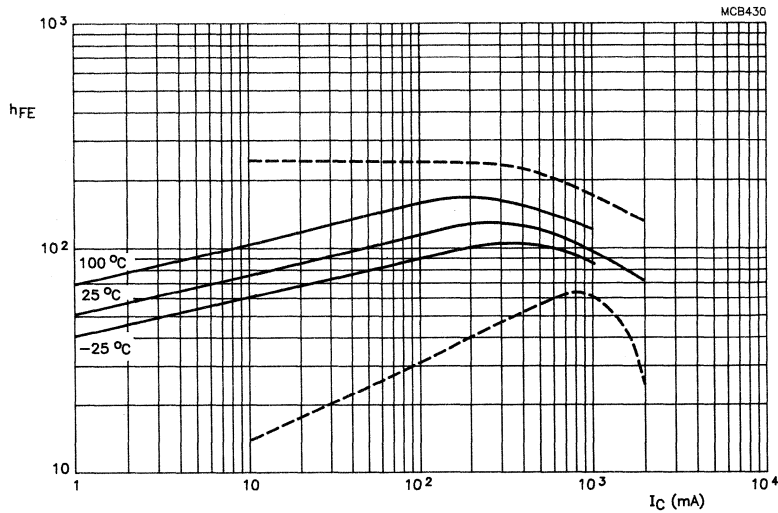

Fig.9 Current gain as a function of collector current; BSX62-10 and BSX63-10;  $V_{CE} = 1\text{ V}$ ; - typical values at  $T_{\text{amb}}$ ; --- minimum values at  $T_{\text{case}} = 25^\circ\text{C}$ .

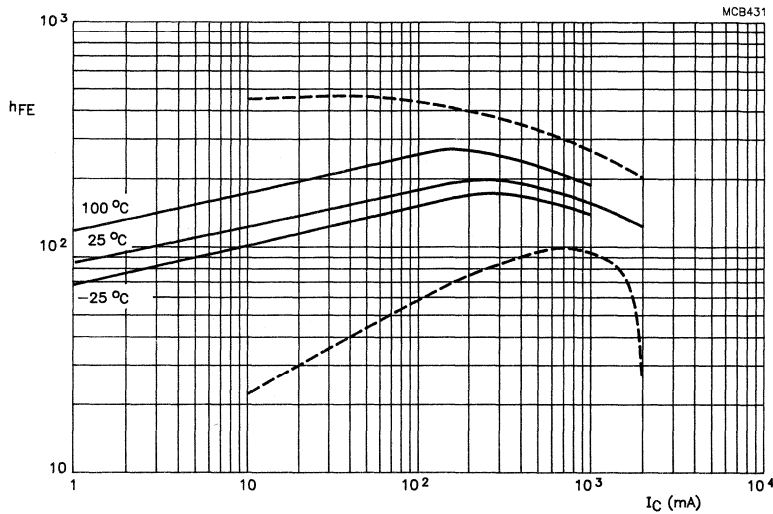

Fig.10 Current gain as a function of collector current; BSX62-16 and BSX63-16;  $V_{CE} = 1\text{ V}$ ; - typical values at  $T_{\text{amb}}$ ; --- minimum values at  $T_{\text{case}} = 25^\circ\text{C}$ .

Silicon planar epitaxial transistors

BSX62-10, -16/BSX63-10, -16

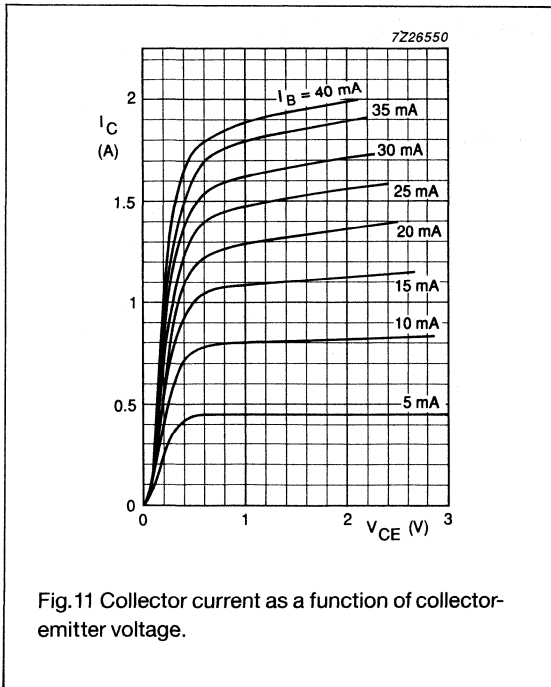

Fig.11 Collector current as a function of collector-emitter voltage.

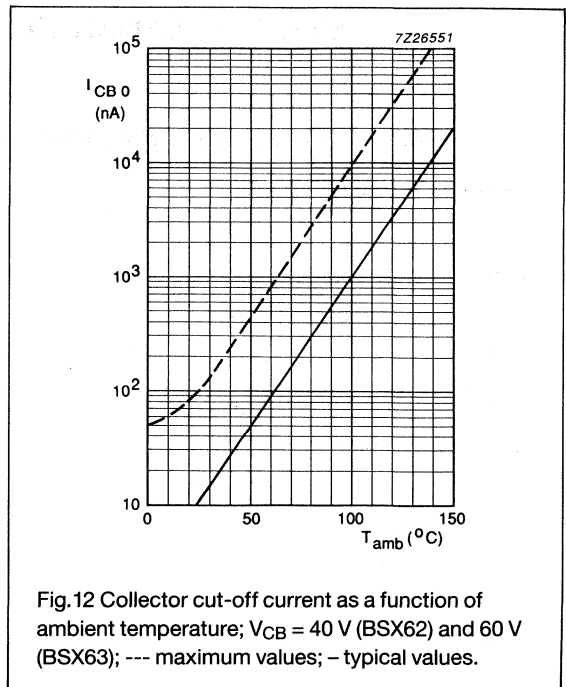

Fig.12 Collector cut-off current as a function of ambient temperature;  $V_{CB} = 40$  V (BSX62) and 60 V (BSX63); --- maximum values; - typical values.

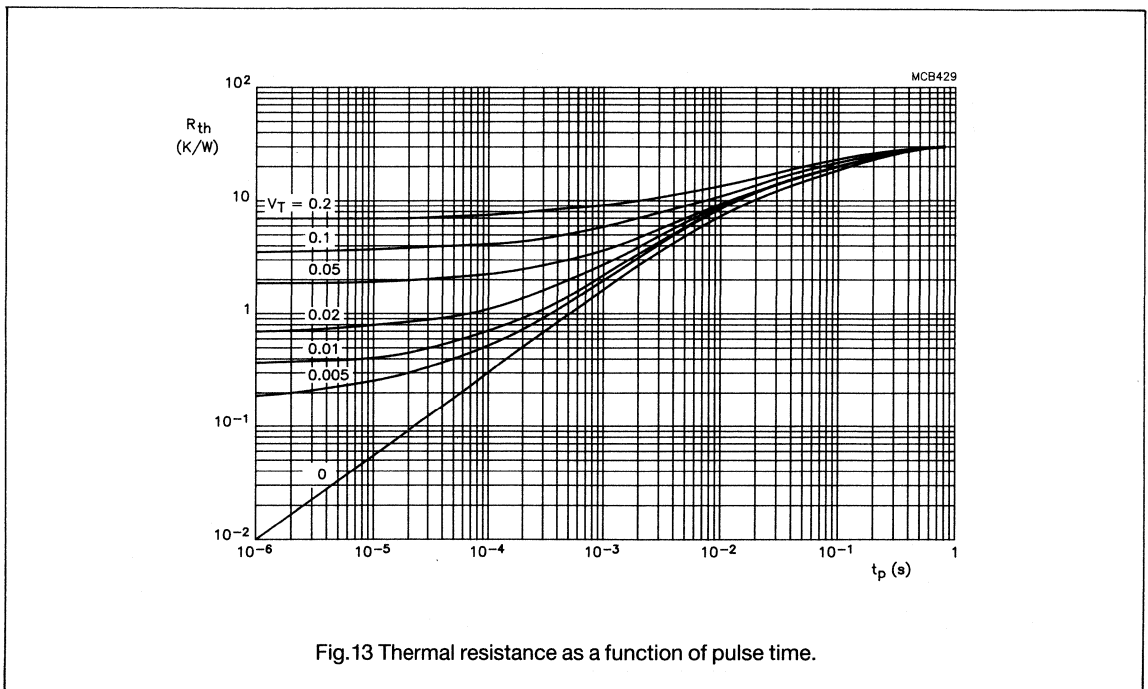

Fig.13 Thermal resistance as a function of pulse time.

## SILICON PLANAR EPITAXIAL TRANSISTOR

NPN transistors in a TO-18 metal envelope intended for general purpose low level switching applications.

### QUICK REFERENCE DATA

Collector-base voltage (open emitter)	$V_{CBO}$	max.	20 V
Collector-emitter voltage (open base)	$V_{CEO}$	max.	15 V
Collector current (peak value)	$I_{CM}$	max.	200 mA
Total power dissipation up to $T_{amb} = 25\text{ }^{\circ}\text{C}$	$P_{tot}$	max.	300 mW
DC current gain	$h_{FE}$		50 to 200
Transition frequency at $f = 100\text{ MHz}$	$f_T$	min.	200 MHz
Storage time	$t_s$	max.	50 ns

### MECHANICAL DATA

Dimensions in mm

Fig. 1 TO-18.

Collector connected to case

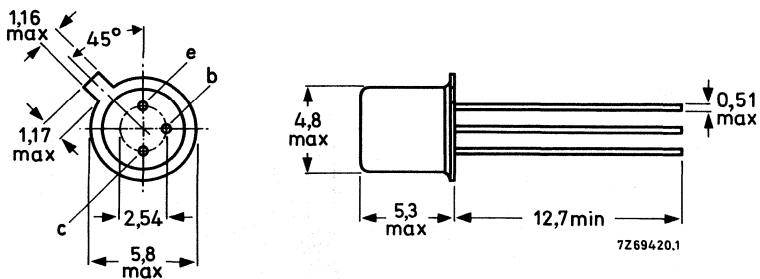

## RATINGS

Limiting values of operation according to the absolute maximum system.

## Electrical

$V_{CBO}$ max.	20	V
$V_{CEO}$ max.	15	V
$V_{EBO}$ max.	5.0	V
$I_{C(AV)}$ max. (see note 1)	100	mA
$I_{CM}$ max.	200	mA
$P_{tot}$ max. ( $T_{amb} \leq 25^{\circ}C$ )	300	mW

## Temperature

$T_{stg}$ min.	-65	$^{\circ}C$
$T_{stg}$ max.	150	$^{\circ}C$
$T_j$ max. (operating)	175	$^{\circ}C$

## THERMAL CHARACTERISTIC

$R_{th(j-a)}$	500	K/W
---------------	-----	-----

ELECTRICAL CHARACTERISTICS ( $T_{amb} = 25^{\circ}C$  unless otherwise stated)

		Min.	Max.	
$I_{CBO}$	Collector cut-off current $V_{CB} = 16V, I_E = 0$	-	50	nA
$V_{BR(CBO)}$	Collector-base breakdown voltage $I_C = 1.0\mu A$	20	-	V
$I_{EBO}$	Emitter cut-off current $V_{EB} = 1.5V, I_C = 0$	-	25	nA
$V_{(BR)EBO}$	Emitter-base breakdown voltage $I_E = 10\mu A$	5.0	-	V
$I_{CEO}$	Collector-emitter cut-off current $V_{CE} = 12V, I_B = 0$	-	250	nA
$V_{(BR)CEO}$	Collector-emitter breakdown voltage $I_C = 10mA$ (see note 2)	15	-	V
$f_T$	Transition frequency $I_C = 10mA, V_{CE} = 9.0V,$ $f = 100MHz$	200	-	MHz

## Notes

1. Averaged over any 20 ms period.
2. Pulsed: Pulse width = 300  $\mu s$ , duty cycle < 2%.

		Min.	Max.	
$h_{FE}$	DC current gain			
	$I_C = 1.0\text{mA}$ , $V_{CE} = 0.35\text{V}$	30	-	
	$I_C = 10\text{mA}$ , $V_{CE} = 0.35\text{V}$	50	200	
$V_{CE(sat)}$	Collector-emitter saturation voltage			
	$I_C = 10\text{mA}$ , $I_B = 0.2\text{mA}$	-	0.35	V
$V_{BE(sat)}$	Base-emitter saturation voltage			
	$I_C = 10\text{mA}$ , $I_B = 0.2\text{mA}$	0.67	0.87	V
$C_{ob}$	Collector-base capacitance			
	$V_{CB} = 9.0\text{V}$ , $I_E = 0$			
	$f = 1.0\text{MHz}$	-	6.0	pF
$t_s$	Storage time			
	$I_C = 10\text{mA}$	-	50	ns
	See test circuit on next page			

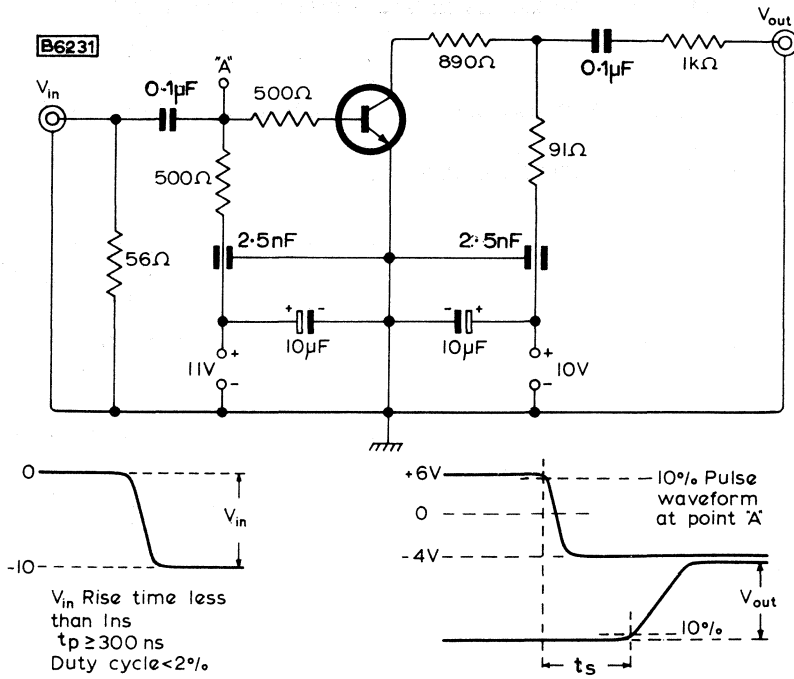

Fig.2 Test circuit and waveforms.





## PNP SMALL-SIGNAL TRANSISTORS

PNP small-signal transistors in TO-92 envelopes, recommended for general purpose amplifier applications.

The complementary types are the JC500 and JC501 respectively.

### QUICK REFERENCE DATA

			JA100	JA101
Collector-base voltage	$-V_{CBS}$	max.	30	50 V
Collector-emitter voltage (open base)	$-V_{CEO}$	max.	25	45 V
Collector current (DC)	$-I_C$	max.	100	mA
DC current gain $-I_C = 1 \text{ mA}; -V_{CE} = 5 \text{ V}$	$h_{FE}$		90 to 600	
Total power dissipation up to $T_{amb} = 25 \text{ }^\circ\text{C}$	$P_{tot}$	max.	500	mW

### MECHANICAL DATA

Dimensions in mm

Fig.1 TO-92.

#### Pinning:

- 1 = base
- 2 = collector
- 3 = emitter

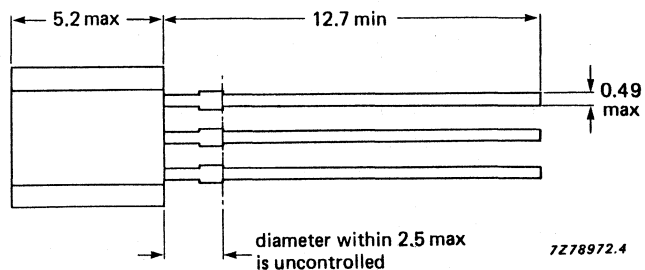
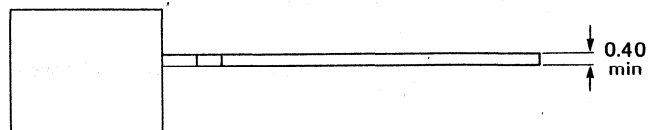
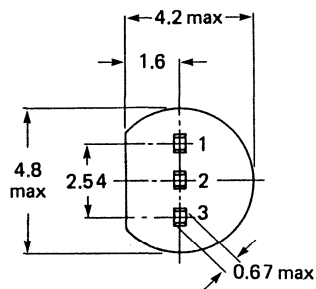
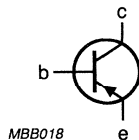

**RATINGS**

Limiting values in accordance with the Absolute Maximum System (IEC 134)

			JA100	JA101
Collector-base voltage	$-V_{CBS}$	max.	30	50 V
Collector-emitter voltage (open base)	$-V_{CEO}$	max.	25	45 V
Emitter-base voltage (open collector)	$-V_{EBO}$	max.	5.0	V
Collector current (DC)	$-I_C$	max.	100	mA
Collector current (peak)	$-I_{CM}$	max.	200	mA
Base current (DC)	$-I_B$	max.	50	mA
Base current (peak)	$-I_{BM}$	max.	100	mA
Total power dissipation up to $T_{amb} = 25\text{ }^\circ\text{C}$	$P_{tot}$	max.	500	mW
Storage temperature range	$T_{stg}$		-65 to +150	$^\circ\text{C}$
Junction temperature	$T_j$	max.	150	$^\circ\text{C}$

**THERMAL RESISTANCE**

From junction to ambient in free air	$R_{th\ j-a}$	=	250	K/W
--------------------------------------	---------------	---	-----	-----

**CHARACTERISTICS**

$T_j = 25\text{ }^\circ\text{C}$  unless otherwise specified

			JA100	JA101
Collector-emitter breakdown voltage $-I_{CES} = 10\text{ }\mu\text{A}$ $-I_{CEO} = 2\text{ mA}$	$-V_{(BR)CES}$	>	30	50 V
	$-V_{(BR)CEO}$	>	25	45 V
Emitter-base breakdown voltage $-I_{EBO} = 10\text{ }\mu\text{A}$	$-V_{(BR)EBO}$	>	5.0	5.0 V
Collector cut-off current $-V_{CE} = 25\text{ V}$ $-V_{CE} = 45\text{ V}$ $-V_{CE} = 25\text{ V}; T_j = 125\text{ }^\circ\text{C}$ $-V_{CE} = 45\text{ V}; T_j = 125\text{ }^\circ\text{C}$	$-I_{CES}$	<	15	- nA
	$-I_{CES}$	<	-	15 nA
	$-I_{CES}$	<	4.0	- $\mu\text{A}$
	$-I_{CES}$	<	-	4.0 $\mu\text{A}$
DC current gain* $-I_C = 1\text{ mA}; -V_{CE} = 5\text{ V}$	$h_{FE}$		90 to 600	
Collector-emitter saturation voltage $-I_C = 10\text{ mA}; -I_B = 0.5\text{ mA}$ $-I_C = 100\text{ mA}; -I_B = 5\text{ mA}$	$-V_{CE\ sat}$	<	0.3	V
	$-V_{CE\ sat}$	typ.	0.5	V
Base-emitter saturation voltage $-I_C = 10\text{ mA}; -I_B = 0.5\text{ mA}$ $-I_C = 100\text{ mA}; -I_B = 5\text{ mA}$	$-V_{BE\ sat}$	typ.	0.7	V
	$-V_{BE\ sat}$	typ.	0.85	V
Base-emitter voltage $-I_C = 2\text{ mA}; -V_{CE} = 5\text{ V}$	$-V_{BE\ on}$		0.55 to 0.7	V

* Group	O	P	Q	R
Range	90 - 180	135 - 270	200 - 400	300 - 600

Transition frequency at $f = 50$ MHz; $-I_C = 10$ mA; $-V_{CE} = 5$ V	$f_T$	typ.	130	MHz
Collector-base capacitance $-V_{CB0} = 10$ V; $f = 1$ MHz	$C_{cb}$	<	6.0	pF
Emitter-base capacitance $-V_{EB0} = 0.5$ V; $f = 1$ MHz	$C_{eb}$	typ.	12	pF
Noise figure at $R_S = 2$ k $\Omega$ ; $f = 1$ kHz; $-I_C = 200$ $\mu$ A; $-V_{CE} = 5$ V	NF	<	10	dB





## SILICON PLANAR EPITAXIAL TRANSISTORS

PNP transistors in plastic TO-92 variant envelopes, primarily intended for use in driver and output stages of audio amplifiers.

The JC327, JC327A, JC328 are complementary to the JC337, JC337A and JC338 respectively.

### QUICK REFERENCE DATA

		JC327	JC327A	JC328	
Collector-emitter voltage ( $V_{BE} = 0$ )	$-V_{CES}$ max.	50	60	30	V
Collector-emitter voltage (open base)	$-V_{CEO}$ max.	45	60	25	V
Collector current (peak value)	$-I_{CM}$ max.		1000		mA
Total power dissipation up to $T_{amb} = 25^\circ\text{C}$	$P_{tot}$ max.		800		mW
Junction temperature	$T_j$ max.		150		$^\circ\text{C}$
Transition frequency at $f = 35$ MHz $-I_C = 10$ mA; $-V_{CE} = 5$ V	$f_T$ typ.		100		MHz
DC current gain $-I_C = 100$ mA; $-V_{CE} = 1$ V	$h_{FE}$		100 to 600		

### MECHANICAL DATA

Dimensions in mm

Fig. 1 TO-92 variant.

#### Pinning:

- 1 = base
- 2 = collector
- 3 = emitter

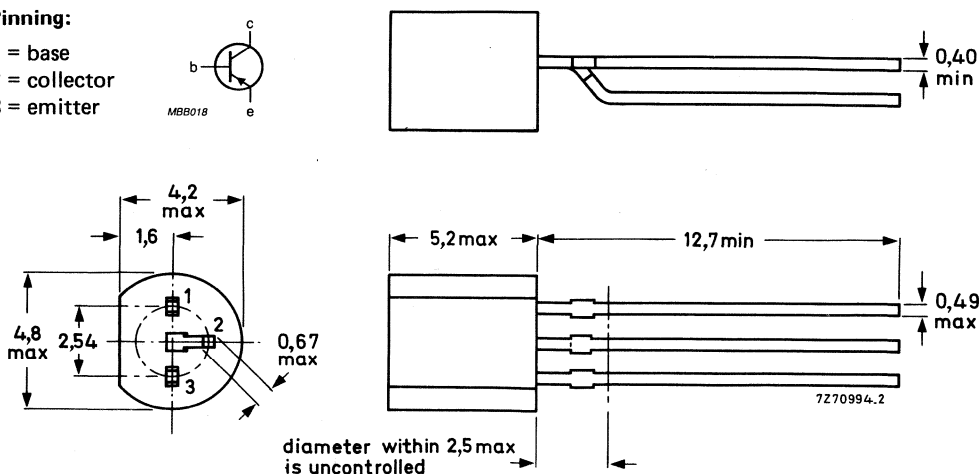
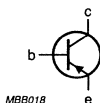

**RATINGS**

Limiting values in accordance with the Absolute Maximum System (IEC 134)

		JC327	JC327A	JC328	
Collector-emitter voltage ( $V_{BE} = 0$ )	$-V_{CES}$ max.	50	60	30	V
Collector-emitter voltage (open base) $-I_C = 10 \text{ mA}$	$-V_{CEO}$ max.	45	60	25	V
Emitter-base voltage (open collector)	$-V_{EBO}$ max.		5		V
Collector current (DC)	$-I_C$ max.		500		mA
Collector current (peak value)	$-I_{CM}$ max.		1000		mA
Emitter current (peak value)	$I_{EM}$ max.		1000		mA
Base current (DC)	$-I_B$ max.		100		mA
Base current (peak value)	$-I_{BM}$ max.		200		mA
Total power dissipation at $T_{amb} = 25 \text{ }^\circ\text{C}$ up to $T_{amb} = 25 \text{ }^\circ\text{C}$	$P_{tot}$ max.		625		mW
	$P_{tot}$ max.		800		mW*
Storage temperature range	$T_{stg}$	-65 to +150			$^\circ\text{C}$
Junction temperature	$T_j$ max.		150		$^\circ\text{C}$

**THERMAL RESISTANCE**

From junction to ambient in free air	$R_{th \text{ j-a}}$ =		0.2		K/mW
From junction to ambient	$R_{th \text{ j-a}}$ =		0.156		K/mW*

\* Transistor mounted on printed-circuit board, max. lead length 4 mm, mounting pad for collector lead min. 10 mm x 10 mm.

**CHARACTERISTICS** $T_j = 25\text{ }^\circ\text{C}$  unless otherwise specified

Collector cut-off current

 $I_E = 0; -V_{CB} = 20\text{ V}; T_j = 25\text{ }^\circ\text{C}$  $-I_{CBO}$  max. 100 nA $I_E = 0; -V_{CB} = 20\text{ V}; T_j = 150\text{ }^\circ\text{C}$  $-I_{CBO}$  max. 5  $\mu\text{A}$ 

Emitter cut-off current

 $I_C = 0; -V_{EB} = 5\text{ V}$  $-I_{EBO}$  max. 10  $\mu\text{A}$ 

Base emitter voltage\*

 $-I_C = 500\text{ mA}; -V_{CE} = 1\text{ V}$  $-V_{BE}$  max. 1.2 V

Saturation voltage

 $-I_C = 500\text{ mA}; -I_B = 50\text{ mA}$  $-V_{CEsat}$  max. 700 mV

DC current gain

 $-I_C = 500\text{ mA}; -V_{CE} = 1\text{ V}$  $h_{FE}$  min. 40 $-I_C = 100\text{ mA}; -V_{CE} = 1\text{ V};$  JC327; JC328 $h_{FE}$  100 to 600

JC327A

 $h_{FE}$  100 to 400

JC327-16 }

 $h_{FE}$  100 to 250

JC328-16 }

JC327-25 }

 $h_{FE}$  160 to 400

JC328-25 }

JC327-40 }

 $h_{FE}$  250 to 600

JC328-40 }

Transition frequency at  $f = 35\text{ MHz}$  $-I_C = 10\text{ mA}; -V_{CE} = 5\text{ V}$  $f_T$  typ. 100 MHzCollector capacitance at  $f = 1\text{ MHz}$  $I_E = I_e = 0; -V_{CB} = 10\text{ V}$  $C_C$  typ. 8 pF**Note**

For characteristics graphs, see BC327/327A/328, Figs 2 to 8.

\*  $-V_{BE}$  decreases by about 2 mV/K with increasing temperature.







## SILICON PLANAR EPITAXIAL TRANSISTORS

NPN transistors in plastic TO-92 variant envelopes, primarily intended for use in driver and output stages of audio amplifiers.

The JC337, JC337A, JC338 are complementary to the JC327, JC327A and JC328 respectively.

### QUICK REFERENCE DATA

			JC337	JC337A	JC338	
Collector-emitter voltage ( $V_{BE} = 0$ )	$V_{CES}$	max.	50	60	30	V
Collector-emitter voltage (open base)	$V_{CEO}$	max.	45	60	25	V
Collector current (peak value)	$I_{CM}$	max.		1000		mA
Total power dissipation up to $T_{amb} = 25\text{ }^{\circ}\text{C}$	$P_{tot}$	max.		800		mW
Junction temperature	$T_j$	max.		150		$^{\circ}\text{C}$
Transition frequency at $f = 35\text{ MHz}$ $I_C = 10\text{ mA}; V_{CE} = 5\text{ V}$	$f_T$	typ.		100		MHz
DC current gain $I_C = 100\text{ mA}; V_{CE} = 1\text{ V}$	$h_{FE}$			100 to 600		

### MECHANICAL DATA

Dimensions in mm

Fig. 1 TO-92 variant.

#### Pinning:

- 1 = base
- 2 = collector
- 3 = emitter

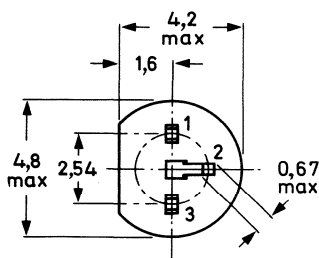
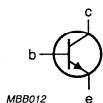

diameter within 2,5 max  
 is uncontrolled

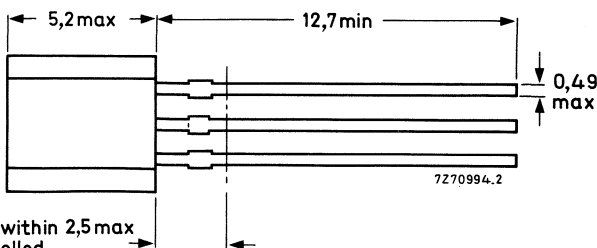

**RATINGS**

Limiting values in accordance with the Absolute Maximum System (IEC 134)

		JC337	JC337A	JC338	
Collector-emitter voltage ( $V_{BE} = 0$ )	$V_{CES}$ max.	50	60	30	V
Collector-emitter voltage (open base) $I_C = 10$ mA	$V_{CEO}$ max.	45	60	25	V
Emitter-base voltage (open collector)	$V_{EBO}$ max.		5		V
Collector current (DC)	$I_C$ max.		500		mA
Collector current (peak value)	$I_{CM}$ max.		1000		mA
Emitter current (peak value)	$-I_{EM}$ max.		1000		mA
Base current (DC)	$I_B$ max.		100		mA
Base current (peak value)	$I_{BM}$ max.		200		mA
Total power dissipation at $T_{amb} = 25$ °C up to $T_{amb} = 25$ °C	$P_{tot}$ max.		625		mW
	$P_{tot}$ max.		800		mW*
Storage temperature range	$T_{stg}$	-65 to +150			°C
Junction temperature	$T_j$ max.		150		°C

**THERMAL RESISTANCE**

From junction to ambient in free air	$R_{th\ j-a}$ =		0.2		K/mW
From junction to ambient	$R_{th\ j-a}$ =		0.156		K/mW*

\* Transistor mounted on printed circuit board, max. lead length 4 mm, mounting pad for collector lead min. 10 mm x 10 mm.

**CHARACTERISTICS** $T_j = 25\text{ }^\circ\text{C}$  unless otherwise specified

Collector cut-off current

 $I_E = 0; V_{CB} = 20\text{ V}; T_j = 25\text{ }^\circ\text{C}$  $I_{CBO}$  max. 100 nA $I_E = 0; V_{CB} = 20\text{ V}; T_j = 150\text{ }^\circ\text{C}$  $I_{CBO}$  max. 5  $\mu\text{A}$ 

Emitter cut-off current

 $I_C = 0; V_{EB} = 5\text{ V}$  $I_{EBO}$  max. 10  $\mu\text{A}$ 

Base emitter voltage\*

 $I_C = 500\text{ mA}; V_{CE} = 1\text{ V}$  $V_{BE}$  max. 1.2 V

Saturation voltage

 $I_C = 500\text{ mA}; I_B = 50\text{ mA}$  $V_{CEsat}$  max. 700 mV

DC current gain

 $I_C = 500\text{ mA}; V_{CE} = 1\text{ V}$  $h_{FE}$  min. 40 $I_C = 100\text{ mA}; V_{CE} = 1\text{ V}; \text{JC337}; \text{JC338}$  $h_{FE}$  100 to 600

JC337A

 $h_{FE}$  100 to 400JC337-16 }  
JC338-16 } $h_{FE}$  100 to 250JC337-25 }  
JC338-25 } $h_{FE}$  160 to 400JC337-40 }  
JC338-40 } $h_{FE}$  250 to 600Transition frequency at  $f = 35\text{ MHz}$  $I_C = 10\text{ mA}; V_{CE} = 5\text{ V}$  $f_T$  typ. 100 MHzCollector capacitance at  $f = 1\text{ MHz}$  $I_E = I_e = 0; V_{CB} = 10\text{ V}$  $C_C$  typ. 5 pF**Note**

For characteristics drawings, see BC337/337A/338, Figs 2 to 8.

\*  $V_{BE}$  decreases by about 2 mV/K with increasing temperature.





## NPN SMALL-SIGNAL TRANSISTORS

NPN small-signal transistors, in TO-92 envelopes. They are recommended for general purpose amplifier applications.

The complementary types are the JA100 and the JA101 respectively.

### QUICK REFERENCE DATA

		JC500	JC501
Collector-emitter voltage	$V_{CES}$	max. 30	50 V
Collector-emitter voltage (open base)	$V_{CEO}$	max. 25	45 V
Collector current (DC)	$I_C$	max. 100	mA
DC current gain $I_C = 1 \text{ mA}; V_{CE} = 5 \text{ V}$	$h_{FE}$	90 to 600	
Total power dissipation up to $T_{amb} = 25 \text{ }^\circ\text{C}$	$P_{tot}$	max. 500	mW

### MECHANICAL DATA

Dimensions in mm

Fig. 1 TO-92.

#### Pinning:

- 1 = base
- 2 = collector
- 3 = emitter

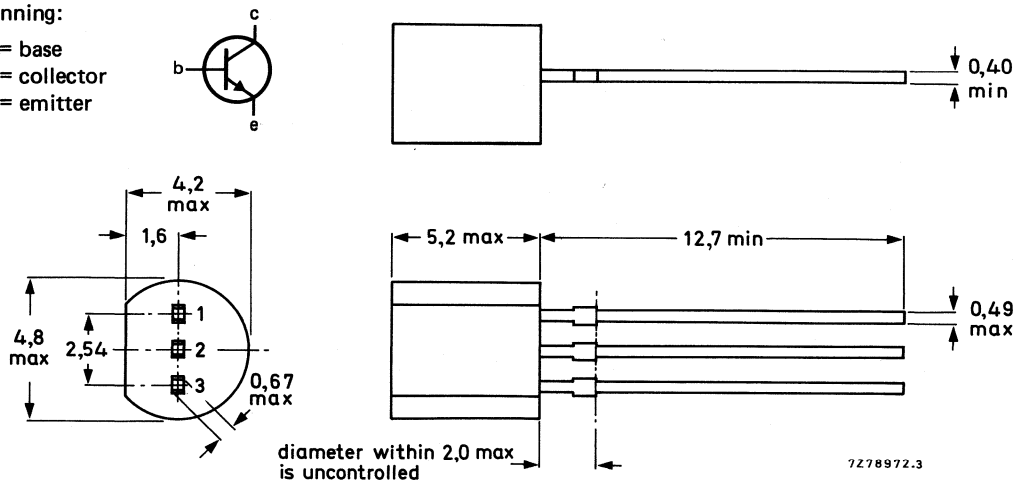

**RATINGS**

Limiting values in accordance with the Absolute Maximum System (IEC 134)

		JC500	JC501
Collector-emitter voltage	$V_{CES}$	max. 30	50 V
Collector-emitter voltage (open base)	$V_{CEO}$	max. 25	45 V
Emitter-base voltage (open collector)	$V_{EBO}$	max. 6.0	V
Collector current (DC)	$I_C$	max. 100	mA
Collector current (peak)	$I_{CM}$	max. 200	mA
Base current (DC)	$I_B$	max. 50	mA
Total power dissipation up to $T_{amb} = 25\text{ }^\circ\text{C}$	$P_{tot}$	max. 500	mW
Storage temperature range	$T_{stg}$	-55 to + 150	$^\circ\text{C}$
Junction temperature	$T_j$	max. 150	$^\circ\text{C}$

**THERMAL RESISTANCE**

From junction to ambient in free air	$R_{th\ j-a}$	=	250	K/W
--------------------------------------	---------------	---	-----	-----

**CHARACTERISTICS**

$T_j = 25\text{ }^\circ\text{C}$  unless otherwise specified

		JC500	JC501
Collector-emitter breakdown voltage $I_{CEO} = 2\text{ mA}$	$V_{(BR)CEO} >$	25	45 V
Emitter-base breakdown voltage $I_{EBO} = 1\text{ }\mu\text{A}$	$V_{(BR)EBO} >$	6.0	6.0 V
Collector cut-off current $V_{CE} = 25\text{ V}$	$I_{CES} <$	15	- nA
$V_{CE} = 45\text{ V}$	$I_{CES} <$	-	15 nA
$V_{CE} = 25\text{ V}; T_j = 125\text{ }^\circ\text{C}$	$I_{CES} <$	4.0	- $\mu\text{A}$
$V_{CE} = 45\text{ V}; T_j = 125\text{ }^\circ\text{C}$	$I_{CES} <$	-	4.0 $\mu\text{A}$
Emitter-base cut-off current $V_{EB} = 6\text{ V}$	$I_{EBO} <$	1.0	$\mu\text{A}$
DC current gain * $I_C = 1\text{ mA}; V_{CE} = 5\text{ V}$	$h_{FE}$	90 to 600	
Collector-emitter saturation voltage $I_C = 10\text{ mA}; I_B = 0.5\text{ mA}$	$V_{CE\ sat} <$	0.2	V
$I_C = 100\text{ mA}; I_B = 5\text{ mA}$	$V_{CE\ sat} <$	0.6	V
Base-emitter saturation voltage $I_C = 10\text{ mA}; I_B = 0.5\text{ mA}$	$V_{BE\ sat} <$	0.83	V
$I_C = 100\text{ mA}; I_B = 5\text{ mA}$	$V_{BE\ sat} <$	1.06	V
Base-emitter voltage $I_C = 2\text{ mA}; V_{CE} = 5\text{ V}$	$V_{BE}$	0.55 to 0.7	V

* Group	O	P	Q	R
Range	90 - 180	135 - 270	200 - 400	300 - 600

Transition frequency at $f = 100$ MHz; $I_C = 10$ mA; $V_{CE} = 5$ V	$f_T$	typ.	130	MHz
Collector-base capacitance $V_{CBO} = 10$ V; $f = 1$ MHz	$C_{cb}$	<	6.0	pF
Emitter-base capacitance $V_{EBO} = 0.5$ V; $f = 1$ MHz	$C_{eb}$	typ.	8.0	pF
Noise figure at $R_S = 2$ k $\Omega$ ; $f = 1$ kHz; $I_C = 200$ $\mu$ A; $-V_{CE} = 5$ V	F	<	10	dB







## SILICON PLANAR EPITAXIAL TRANSISTORS

General purpose NPN transistors in a plastic TO-92, especially suitable for use in driver stages of audio amplifiers.

### QUICK REFERENCE DATA

		JC546	JC547	JC548
Collector-emitter voltage ( $V_{BE} = 0$ )	$V_{CES}$ max.	80	50	30 V
Collector-emitter voltage (open base)	$V_{CEO}$ max.	65	45	30 V
Collector current (peak value)	$I_{CM}$ max.	200	200	200 mA
Total power dissipation up to $T_{amb} = 25\text{ }^{\circ}\text{C}$	$P_{tot}$ max.	500	500	500 mW
Junction temperature	$T_j$ max.	150	150	150 $^{\circ}\text{C}$
DC current gain $I_C = 2\text{ mA}; V_{CE} = 5\text{ V}$	$h_{FE} >$	110	110	110
	$h_{FE} <$	450	800	800
Transition frequency $I_C = 10\text{ mA}; V_{CE} = 5\text{ V}$	$f_T$ typ.	300	300	300 MHz
	$F$ typ.	2	2	2 dB
Noise figure at $R_S = 2\text{ k}\Omega$ $I_C = 200\text{ }\mu\text{A}; V_{CE} = 5\text{ V}$ $f = 1\text{ kHz}; B = 200\text{ Hz}$				

### MECHANICAL DATA

Dimensions in mm

Fig. 1 TO-92.

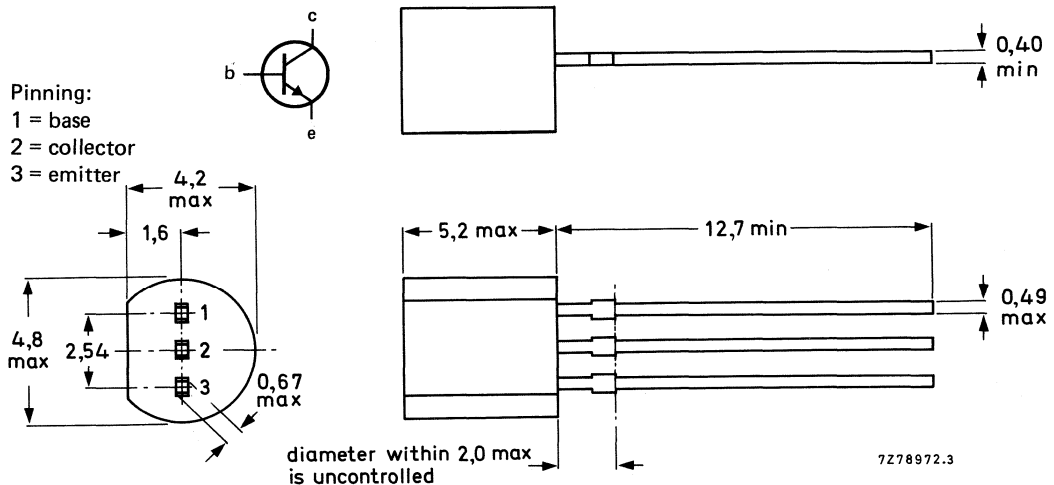

**RATINGS**

Limiting values in accordance with the Absolute Maximum System (IEC 134)

		JC546	JC547	JC548
Collector-base voltage (open emitter)	$V_{CB0}$	max. 80	50	30 V
Collector-emitter voltage ( $V_{BE} = 0$ )	$V_{CES}$	max. 80	50	30 V
Collector-emitter voltage (open base)	$V_{CEO}$	max. 65	45	30 V
Emitter-base voltage (open collector)	$V_{EBO}$	max. 6	6	5 V
Collector current (DC)	$I_C$	max.	100	mA
Collector current (peak value)	$I_{CM}$	max.	200	mA
Emitter current (peak value)	$-I_{EM}$	max.	200	mA
Base current (peak value)	$I_{BM}$	max.	200	mA
Total power dissipation up to $T_{amb} = 25\text{ }^\circ\text{C}$	$P_{tot}$	max.	500	mW
Storage temperature range	$T_{stg}$		-65 to + 150	$^\circ\text{C}$
Junction temperature	$T_j$	max.	150	$^\circ\text{C}$

**THERMAL RESISTANCE**

From junction to ambient in free air	$R_{th\ j-a}$	=	0,25	K/mW
From junction to case	$R_{th\ j-c}$	=	0,15	K/mW

**CHARACTERISTICS**

$T_j = 25\text{ }^\circ\text{C}$  unless otherwise specified

Collector cut-off current

$I_E = 0; V_{CB} = 30\text{ V}$

$I_{CBO} < 15\text{ nA}$

$I_E = 0; V_{CB} = 30\text{ V}; T_j = 150\text{ }^\circ\text{C}$

$I_{CBO} < 5\text{ }\mu\text{A}$

Base-emitter voltage\*

$I_C = 2\text{ mA}; V_{CE} = 5\text{ V}$

$V_{BE} \text{ typ. } 660\text{ mV}$   
 $580\text{ to }700\text{ mV}$

$I_C = 10\text{ mA}; V_{CE} = 5\text{ V}$

$V_{BE} < 770\text{ mV}$

\*  $V_{BE}$  decreases by about 2 mV/K with increasing temperature.

## Saturation voltage\*

$I_C = 10 \text{ mA}; I_B = 0,5 \text{ mA}$

$V_{CEsat}$	typ.	90 mV
	<	250 mV

$V_{BEsat}$	typ.	700 mV
-------------	------	--------

$I_C = 100 \text{ mA}; I_B = 5 \text{ mA}$

$V_{CEsat}$	typ.	200 mV
	<	600 mV

$V_{BEsat}$	typ.	900 mV
-------------	------	--------

Collector capacitance at  $f = 1 \text{ MHz}$ 

$I_E = I_e = 0; V_{CB} = 10 \text{ V}$

$C_C$	typ.	2,5 pF
-------	------	--------

Emitter capacitance at  $f = 1 \text{ MHz}$ 

$I_C = I_c = 0; V_{EB} = 0,5 \text{ V}$

$C_e$	typ.	9 pF
-------	------	------

Transition frequency at  $f = 35 \text{ MHz}$ 

$I_C = 10 \text{ mA}; V_{CE} = 5 \text{ V}$

$f_T$	typ.	300 MHz
-------	------	---------

Small signal current gain at  $f = 1 \text{ kHz}$ 

$I_C = 2 \text{ mA}; V_{CE} = 5 \text{ V}$

$h_{fe}$	125 to 900		
----------	------------	--	--

Noise figure at  $R_S = 2 \text{ k}\Omega$ 

$I_C = 200 \mu\text{A}; V_{CE} = 5 \text{ V}$

$f = 1 \text{ kHz}; B = 200 \text{ Hz}$

		JC546	JC547	JC548
F	typ.	2	2	2 dB
	<	10	10	10 dB

## DC current gain

$I_C = 10 \mu\text{A}; V_{CE} = 5 \text{ V}$

		JC546A	JC546B		
		JC547A	JC547B	JC547C	
		JC548A	JC548B	JC548C	
$h_{FE}$	typ.	90	150	270	
	>	110	200	420	
$h_{FE}$	typ.	180	290	520	
	<	220	450	800	

$I_C = 2 \text{ mA}; V_{CE} = 5 \text{ V}$

\*  $V_{BEsat}$  decreases by about 1,7 mV/K with increasing temperature.

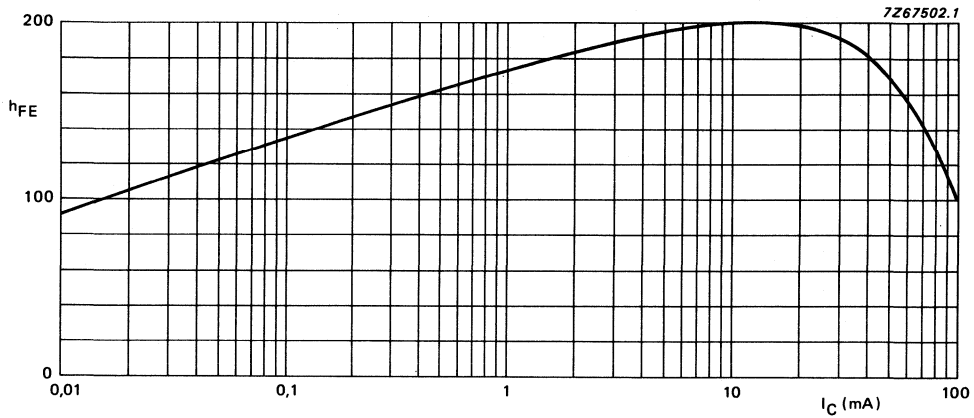

Fig. 2 JC546A; JC547A and JC548A  
 $V_{CE} = 5\text{ V}$ ;  $T_j = 25\text{ }^\circ\text{C}$ ; typical values.

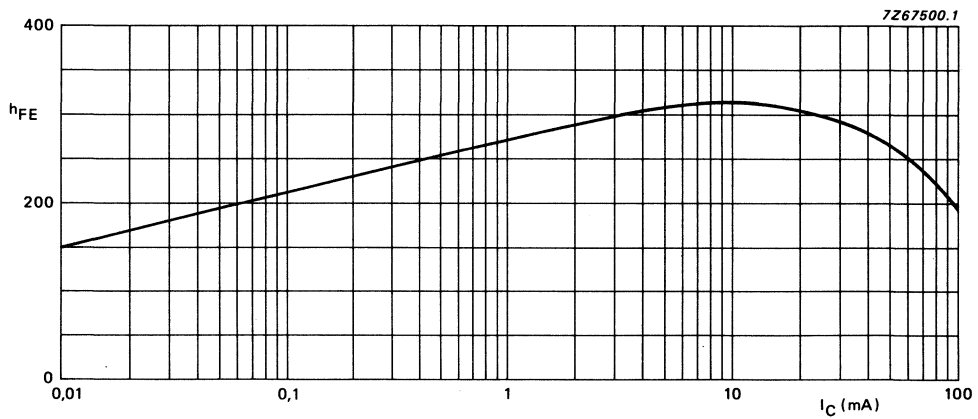

Fig. 3 JC546B; JC547B and JC548B  
 $V_{CE} = 5\text{ V}$ ;  $T_j = 25\text{ }^\circ\text{C}$ ; typical values.

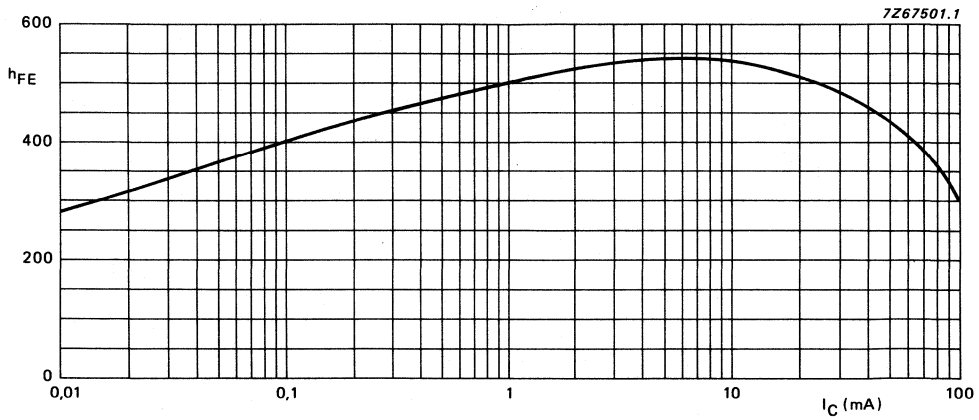

Fig. 4 JC547C and JC548C  
 $V_{CE} = 5 \text{ V}$ ;  $T_j = 25 \text{ }^\circ\text{C}$ ; typical values.

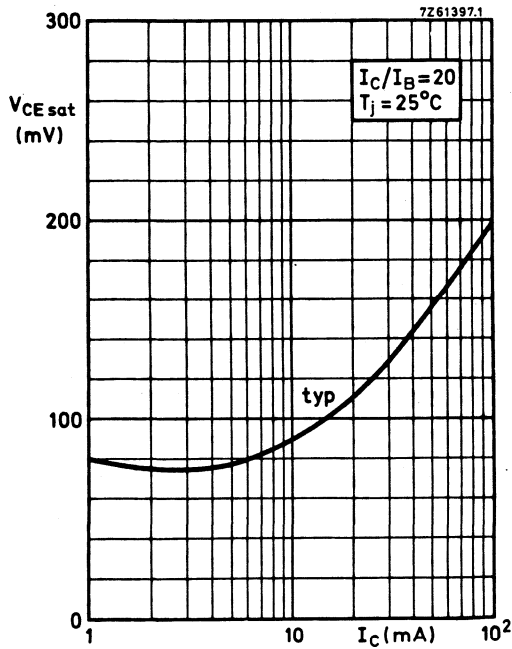

Fig. 5.

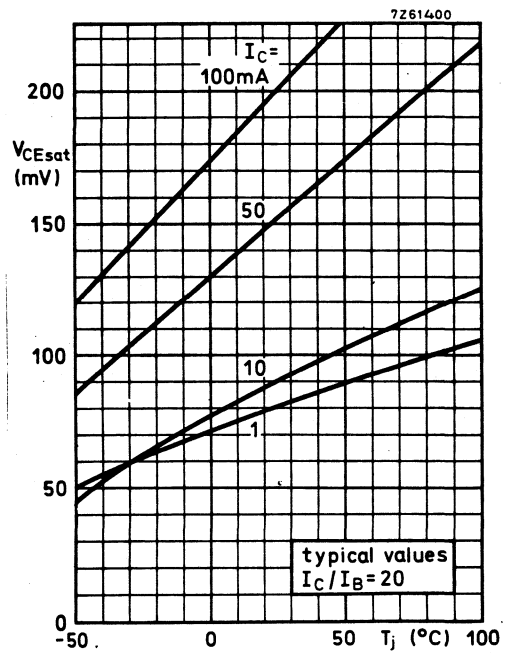

Fig. 6.

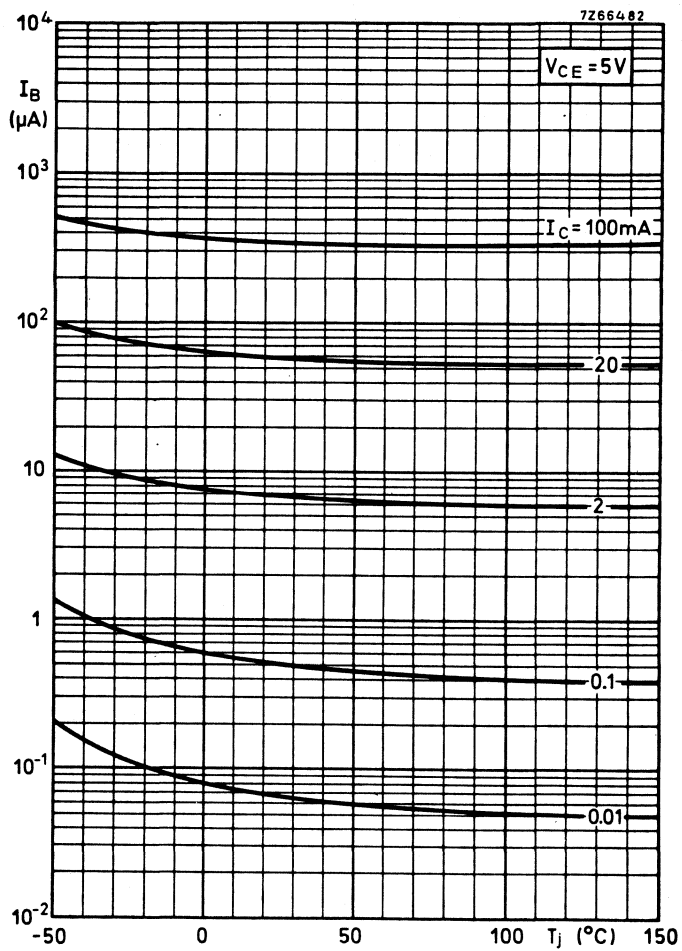

Fig. 7.

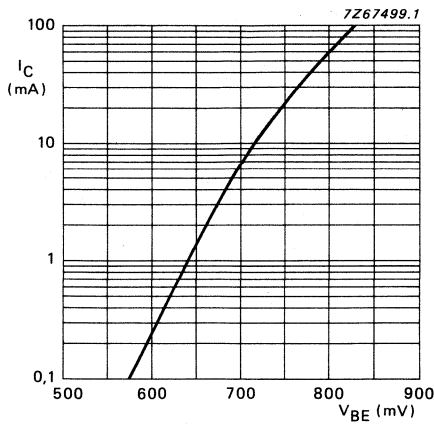

Fig. 8  $V_{CE} = 5 \text{ V}$ ;  $T_j = 25 \text{ }^\circ\text{C}$ ; typical values.

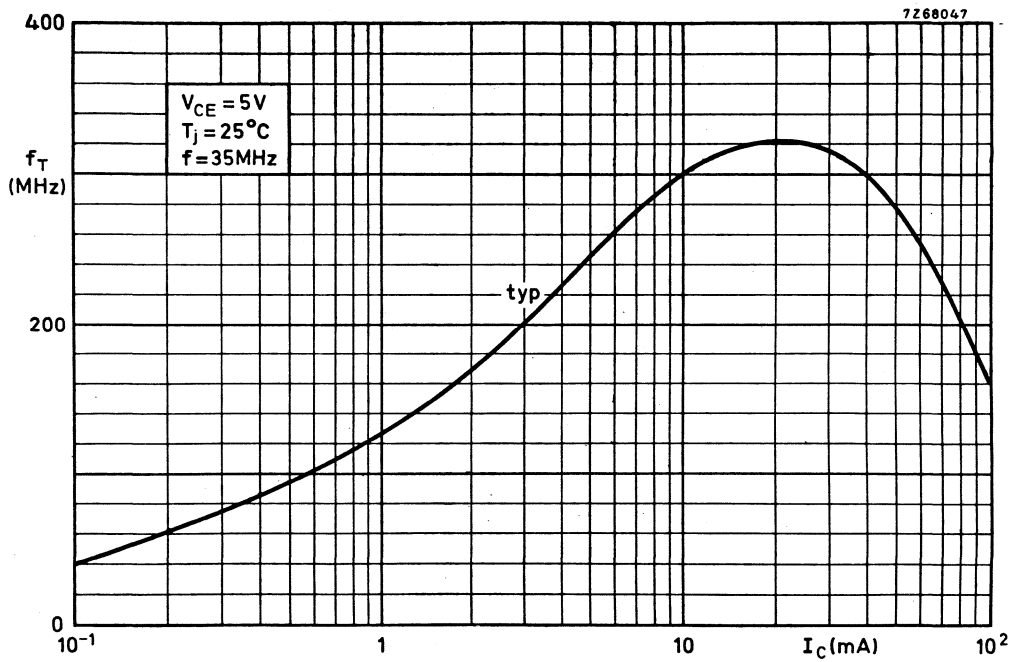

Fig. 9.

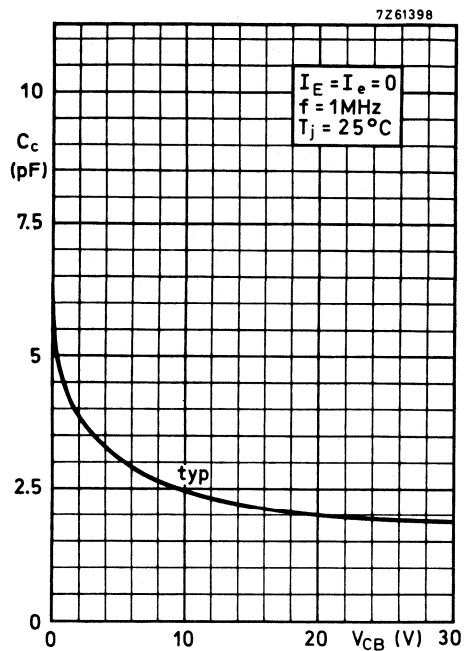

Fig. 10.

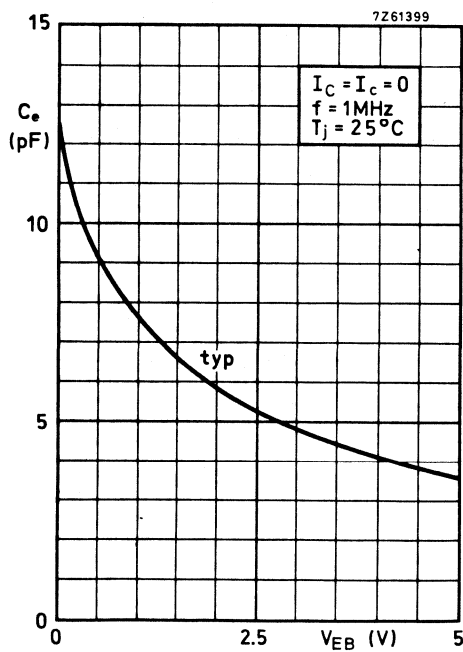

Fig. 11.



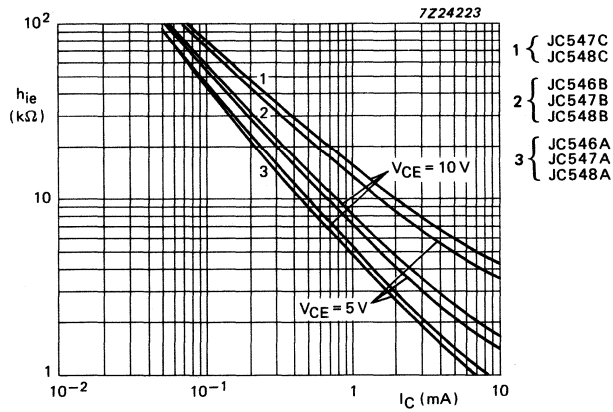

Fig. 12.

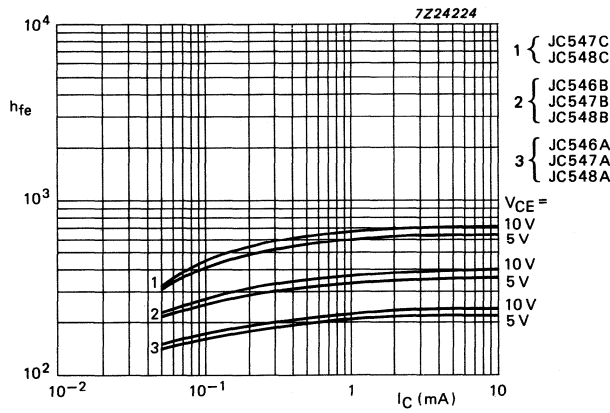

Fig. 13.

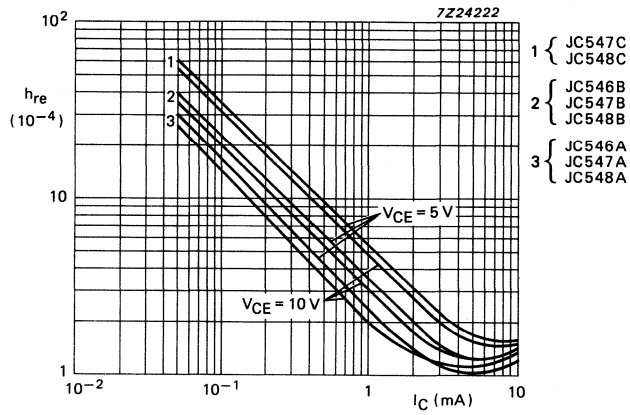

Fig. 14.

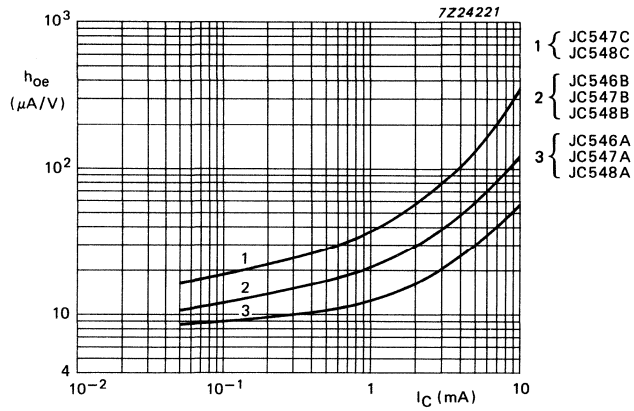

Fig. 15.



## SILICON PLANAR EPITAXIAL TRANSISTORS

NPN transistors in plastic TO-92 variants, primarily intended for low-noise input stages in tape recorders, hi-fi amplifiers and other audio-frequency equipment.

### QUICK REFERENCE DATA

		JC549	JC550
Collector-emitter voltage ( $V_{BE} = 0$ )	$V_{CES}$ max.	30	50 V
Collector-emitter voltage (open base)	$V_{CEO}$ max.	30	45 V
Collector current (peak value)	$I_{CM}$ max.	200	200 mA
Total power dissipation up to $T_{amb} = 25\text{ }^{\circ}\text{C}$	$P_{tot}$ max.	500	500 mW
Junction temperature	$T_j$ max.	150	150 $^{\circ}\text{C}$
DC current gain	$h_{FE}$ min.	200	200
$I_C = 2\text{ mA}; V_{CE} = 5\text{ V}$	$h_{FE}$ max.	800	800
Transition frequency	$f_T$ typ.	300	300 MHz
$I_C = 10\text{ mA}; V_{CE} = 5\text{ V}$			
Noise figure at $R_S = 2\text{ k}\Omega$	F typ.	1.4	1.4 dB
$I_C = 200\text{ }\mu\text{A}; V_{CE} = 5\text{ V}$	F max.	4	3 dB
$f = 30\text{ Hz to } 15\text{ kHz}$			
$f = 1\text{ kHz}; B = 200\text{ Hz}$	F typ.	1.2	1 dB
$f = 10\text{ Hz to } 50\text{ Hz}$ (equivalent noise voltage)	$V_n$ min.	—	0.135 $\mu\text{V}$

### MECHANICAL DATA

Fig. 1 TO-92 variant.

#### Pinning:

- 1 = base
- 2 = collector
- 3 = emitter

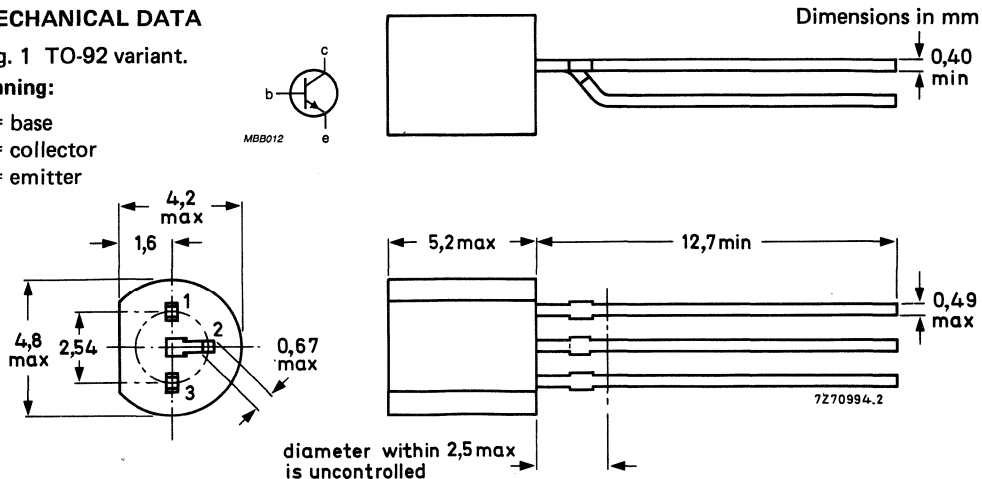

**RATINGS**

Limiting values in accordance with the Absolute Maximum System (IEC 134)

		JC549	JC550
Collector-base voltage (open emitter)	$V_{CBO}$	max. 30	50 V
Collector-emitter voltage ( $V_{BE} = 0$ )	$V_{CES}$	max. 30	50 V
Collector-emitter voltage (open base)	$V_{CEO}$	max. 30	45 V
Emitter-base voltage (open collector)	$V_{EBO}$	max. 5	5 V
Collector current (DC)	$I_C$	max.	100 mA
Collector current (peak value)	$I_{CM}$	max.	200 mA
Emitter current (peak value)	$-I_{EM}$	max.	200 mA
Base current (peak value)	$I_{BM}$	max.	200 mA
Total power dissipation up to $T_{amb} = 25\text{ }^\circ\text{C}$	$P_{tot}$	max.	500 mW
Storage temperature range	$T_{stg}$		-65 to + 150 $^\circ\text{C}$
Junction temperature	$T_j$	max.	150 $^\circ\text{C}$

**THERMAL RESISTANCE**

From junction to ambient in free air	$R_{th\ j-a}$	=	0.25	K/mW
From junction to case	$R_{th\ j-c}$	=	0.15	K/mW

**CHARACTERISTICS**

$T_j = 25\text{ }^\circ\text{C}$  unless otherwise specified

Collector cut-off current

$I_E = 0; V_{CB} = 30\text{ V}$

$I_E = 0; V_{CB} = 30\text{ V}; T_j = 150\text{ }^\circ\text{C}$

$I_{CBO}$	max.	15	nA
$I_{CBO}$	max.	5	$\mu\text{A}$

Base emitter voltage\*

$I_C = 2\text{ mA}; V_{CE} = 5\text{ V}$

$V_{BE}$	typ.	660	mV
		580 to 700	mV

$I_C = 10\text{ mA}; V_{CE} = 5\text{ V}$

$V_{BE}$	max.	770	mV
----------	------	-----	----

Saturation voltages \*\*

$I_C = 10\text{ mA}; I_B = 0,5\text{ mA}$

$V_{CEsat}$	typ.	90	mV
	max.	250	mV

$V_{BEsat}$	typ.	700	mV
-------------	------	-----	----

$I_C = 100\text{ mA}; I_B = 5\text{ mA}$

$V_{CEsat}$	typ.	200	mV
	max.	600	mV

$V_{BEsat}$	typ.	900	mV
-------------	------	-----	----

\*  $V_{BE}$  decreases by about 2 mV/K with increasing temperature.

\*\*  $V_{BEsat}$  decreases by about 1.7 mV/K with increasing temperature.

Collector capacitance at $f = 1$ MHz $I_E = I_e = 0$ ; $V_{CB} = 10$ V	$C_c$	typ.	2.5 pF										
Emitter capacitance at $f = 1$ MHz $I_C = I_c = 0$ ; $V_{EB} = 0,5$ V	$C_e$	typ.	9 pF										
Transition frequency at $f = 35$ MHz $I_C = 10$ mA; $V_{CE} = 5$ V	$f_T$	typ.	300 MHz										
Small signal current gain at $f = 1$ kHz $I_C = 2$ mA; $V_{CE} = 5$ V	$h_{fe}$		125 – 900										
Noise figure at $R_S = 2$ k $\Omega$ $I_C = 200$ $\mu$ A; $V_{CE} = 5$ V $f = 30$ Hz to 15 kHz	F		<table border="1"> <thead> <tr> <th></th> <th>JC549</th> <th>JC550</th> </tr> </thead> <tbody> <tr> <td>typ.</td> <td>1.4</td> <td>1.4 dB</td> </tr> <tr> <td>max.</td> <td>4</td> <td>3 dB</td> </tr> </tbody> </table>			JC549	JC550	typ.	1.4	1.4 dB	max.	4	3 dB
	JC549	JC550											
typ.	1.4	1.4 dB											
max.	4	3 dB											
$f = 1$ kHz; $B = 200$ Hz	F		<table border="1"> <tbody> <tr> <td>typ.</td> <td>1.2</td> <td>1 dB</td> </tr> <tr> <td>max.</td> <td>4</td> <td>4 dB</td> </tr> </tbody> </table>		typ.	1.2	1 dB	max.	4	4 dB			
typ.	1.2	1 dB											
max.	4	4 dB											
Equivalent noise voltage at $R_S = 2$ k $\Omega$ $I_C = 200$ $\mu$ A; $V_{CE} = 5$ V $f = 10$ Hz to 50 Hz; $T_{amb} = 25$ $^{\circ}$ C	$V_n$	max.	—	0.135 $\mu$ V									
DC current gain $I_C = 10$ $\mu$ A; $V_{CE} = 5$ V	$h_{FE}$	typ.	150	270									
$I_C = 2$ mA; $V_{CE} = 5$ V	$h_{FE}$	min.	200	420									
		typ.	290	520									
		max.	450	800									

**Note**

For characteristics graphs, see BC549/550, Figs 2 to 19.





## SILICON PLANAR EPITAXIAL TRANSISTORS

General purpose pnp transistors in plastic TO-92 envelopes, especially suitable for use in driver stages of audio amplifiers.

### QUICK REFERENCE DATA

		JC556	JC557	JC558	
Collector-emitter voltage (+ $V_{BE} = 0$ V)	$-V_{CES}$ max.	80	50	30	V
Collector-emitter voltage (open base)	$-V_{CEO}$ max.	65	45	30	V
DC current gain $-I_C = 2$ mA; $-V_{CE} = 5$ V	$h_{FE}$ min.	75	75	75	
	$h_{FE}$ max.	475	800	800	
Collector current (peak value)	$-I_{CM}$ max.		200		mA
Total power dissipation up to $T_{amb} = 25$ °C	$P_{tot}$ max.		500		mW
Junction temperature	$T_j$ max.		150		°C
Transition frequency at $f = 35$ MHz $-I_C = 10$ mA; $-V_{CE} = 5$ V	$f_T$ typ.		200		MHz
Noise figure at $R_S = 2$ k $\Omega$ $-I_C = 200$ $\mu$ A; $-V_{CE} = 5$ V $f = 1$ kHz; $B = 200$ Hz	F typ.		2		dB

### MECHANICAL DATA

Dimensions in mm

Fig. 1 TO-92

#### Pinning:

- 1 = base
- 2 = collector
- 3 = emitter

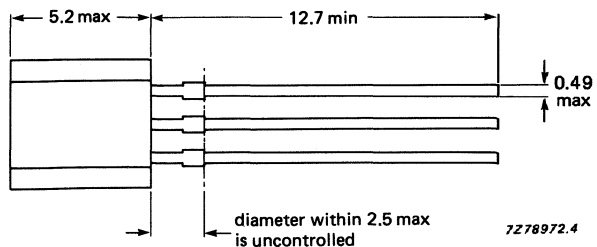
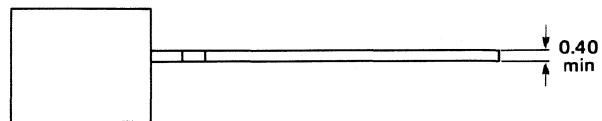
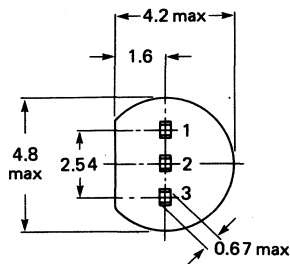
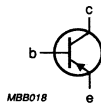

**RATINGS**

Limiting values in accordance with the Absolute Maximum System (IEC 134)

			JC556	JC557	JC558	
Collector-base voltage (open emitter)	$-V_{CBO}$	max.	80	50	30	V
Collector-emitter voltage ( $V_{BE} = 0$ )	$-V_{CES}$	max.	80	50	30	V
Collector-emitter voltage (open base)	$-V_{CEO}$	max.	65	45	30	V
Emitter-base voltage (open collector)	$-V_{EBO}$	max.	5	5	5	V
Collector current (DC)	$-I_C$	max.		100		mA
Collector current (peak value)	$-I_{CM}$	max.		200		mA
Emitter current (peak value)	$I_{EM}$	max.		200		mA
Base current (peak value)	$-I_{BM}$	max.		200		mA
Total power dissipation up to $T_{amb} = 25\text{ }^\circ\text{C}$	$P_{tot}$	max.		500		mW
Storage temperature range	$T_{stg}$		-65 to + 150			$^\circ\text{C}$
Junction temperature	$T_j$	max.		150		$^\circ\text{C}$

**THERMAL RESISTANCE**

From junction to ambient in free air	$R_{th\ j-a}$	=		250		K/W
From junction to case	$R_{th\ j-c}$	=		150		K/W

**CHARACTERISTICS**

$T_j = 25\text{ }^\circ\text{C}$  unless otherwise specified.

Collector cut-off current						
$I_E = 0; -V_{CB} = 30\text{ V}; T_j = 25\text{ }^\circ\text{C}$	$-I_{CBO}$	typ.		1		nA
		max.		15		nA
$T_j = 150\text{ }^\circ\text{C}$	$-I_{CBO}$	max.		4		$\mu\text{A}$
Base-emitter voltage (see note 1)						
$-I_C = 2\text{ mA}; -V_{CE} = 5\text{ V}$	$-V_{BE}$	typ.		650		mV
				600 to 750		mV
$-I_C = 10\text{ mA}; -V_{CE} = 5\text{ V}$	$-V_{BE}$	max.		820		mV
Saturation voltages (see note 2)						
$-I_C = 10\text{ mA}; -I_B = 0.5\text{ mA}$	$-V_{CEsat}$	typ.		60		mV
		max.		300		mV
	$-V_{BEsat}$	typ.		750		mV
$-I_C = 100\text{ mA}; -I_B = 5\text{ mA}$	$-V_{CEsat}$	typ.		180		mV
		max.		650		mV
	$-V_{BEsat}$	typ.		930		mV

**Notes**

1.  $-V_{BE}$  decreases by about 2 mV/K with increasing temperature.
2.  $-V_{BEsat}$  decreases by about 1.7 mV/K with increasing temperature.



Collector capacitance at  $f = 1$  MHz

$$I_E = I_e = 0; -V_{CE} = 10 \text{ V}$$

$C_c$	typ.	4	pF
-------	------	---	----

Transition frequency at  $f = 35$  MHz

$$-I_C = 10 \text{ mA}; -V_{CE} = 5 \text{ V}$$

$f_T$	typ.	200	MHz
-------	------	-----	-----

Small-signal current gain at  $f = 1$  kHz

$$-I_C = 2 \text{ mA}; -V_{CE} = 5 \text{ V}$$

$h_{fe}$		75 to 900	
----------	--	-----------	--

Noise figure at  $R_S = 2 \text{ k}\Omega$ 

$$-I_C = 200 \mu\text{A}; -V_{CE} = 5 \text{ V}$$

$$f = 1 \text{ kHz}; B = 200 \text{ Hz}$$

$F$	typ.	2	dB
	max.	10	dB

DC current gain

$$-I_C = 2 \text{ mA}; -V_{CE} = 5 \text{ V}$$

$h_{FE}$	min.	75	75	125	220	420
	max.	475	800	250	475	800

	JC556	JC557 JC558	JC556A JC557A JC558A	JC556B JC557B JC558B	JC557C JC558C
--	-------	----------------	----------------------------	----------------------------	------------------

**Note**

For characteristics graphs, see BC556 to 558, Figs 2 to 15.





## SILICON PLANAR EPITAXIAL TRANSISTORS

PNP transistors in a plastic TO-92 variant, primarily intended for low-noise input stages in tape recorders, hi-fi amplifiers and other audio-frequency equipment.

### QUICK REFERENCE DATA

		JC559	JC560
Collector-emitter voltage (+ $V_{BE} = 0$ V)	$-V_{CES}$ max.	30	50 V
Collector-emitter voltage (open base)	$-V_{CEO}$ max.	30	45 V
Collector current (peak value)	$-I_{CM}$ max.	200	200 mA
Total power dissipation up to $T_{amb} = 25$ °C	$P_{tot}$ max.	500	500 mW
Junction temperature	$T_j$ max.	150	150 °C
DC current gain	$h_{FE}$ min.	125	125
$-I_C = 2$ mA; $-V_{CE} = 5$ V	$h_{FE}$ max.	800	800
Transition frequency	$f_T$ typ.	200	200 MHz
$-I_C = 10$ mA; $-V_{CE} = 5$ V			
Noise figure at $R_s = 2$ k $\Omega$	F typ.	1.2	1 dB
$-I_C = 200$ $\mu$ A; $-V_{CE} = 5$ V	F max.	4	3 dB
$f = 30$ Hz to 15 kHz			
$f = 1$ kHz; B = 200 Hz	F max.	4	4 dB
$f = 10$ kHz to 50 Hz (equivalent noise voltage)	$V_N$ max.	—	0.11 $\mu$ V

### MECHANICAL DATA

Fig. 1 TO-92 variant.

#### Pinning:

- 1 = base
- 2 = collector
- 3 = emitter

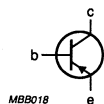

MB8018

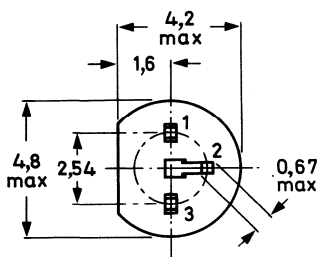

diameter within 2,5 max is uncontrolled

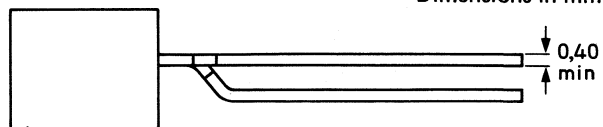

Dimensions in mm

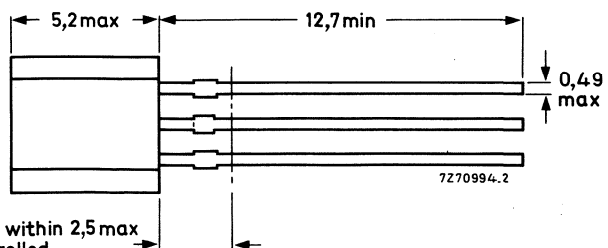

## RATINGS

Limiting values in accordance with the Absolute Maximum System (IEC 134)

		JC559	JC560
Collector-base voltage (open emitter)	$-V_{CB0}$ max.	30	50 V
Collector-emitter voltage (+ $V_{BE} = 0$ V)	$-V_{CES}$ max.	30	50 V
Collector-emitter voltage (open base)	$-V_{CEO}$ max.	30	45 V
Emitter-base voltage (open collector)	$-V_{CBO}$ max.	5	5 V
Collector current (DC)	$-I_C$ max.	100	mA
Collector current (peak value)	$-I_{CM}$ max.	200	mA
Emitter current (peak value)	$I_{EM}$ max.	200	mA
Base current (peak value)	$-I_{BM}$ max.	200	mA
Total power dissipation up to $T_{amb} = 25$ °C	$P_{tot}$ max.	500	mW
Storage temperature range	$T_{stg}$	-65 to +150 °C	
Junction temperature	$T_j$ max.	150	°C

## THERMAL RESISTANCE

From junction to ambient in free air	$R_{th j-a}$ =	250	K/W
From junction to case	$R_{th j-c}$ =	150	K/W

## CHARACTERISTICS

$T_j = 25$  °C unless otherwise specified

Collector cut-off current

$I_E = 0$ ; $-V_{CB} = 30$ V; $T_j = 25$ °C	$-I_{CBO}$ typ.	1	nA
	$-I_{CBO}$ max.	15	nA
$T_j = 150$ °C	$-I_{CBO}$ max.	4	$\mu$ A

Base-emitter voltage\*

$-I_C = 2$ mA; $-V_{CE} = 5$ V	$-V_{BE}$ typ.	650	mV
$-I_C = 10$ mA; $-V_{CE} = 5$ V	$-V_{BE}$ max.	600 to 750	mV
		820	mV

Saturation voltages\*\*

$-I_C = 10$ mA; $-I_B = 0,5$ mA	$-V_{CEsat}$ typ.	60	mV
	$-V_{CEsat}$ max.	300	mV
	$-V_{BEsat}$ typ.	750	mV
$-I_C = 100$ mA; $-I_B = 5$ mA	$-V_{CEsat}$ typ.	180	mV
	$-V_{CEsat}$ max.	650	mV
	$-V_{BEsat}$ typ.	930	mV

\*  $-V_{BE}$  decreases by about 2 mV/K with increasing temperature.

\*\*  $-V_{BEsat}$  decreases by about 1.7 mV/K with increasing temperature.

Collector capacitance at  $f = 1$  MHz

$$I_E = I_e = 0; -V_{CB} = 10 \text{ V}$$

 $C_c$  typ. 4 pFTransition frequency at  $f = 35$  MHz

$$-I_C = 10 \text{ mA}; -V_{CE} = 5 \text{ V}$$

 $f_T$  typ. 200 MHzSmall-signal current gain at  $f = 1$  kHz

$$-I_C = 2 \text{ mA}; -V_{CE} = 5 \text{ V}$$

 $h_{fe}$  125 to 900Noise figure at  $R_S = 2 \text{ k}\Omega$ 

$$-I_C = 200 \mu\text{A}; -V_{CE} = 5 \text{ V}$$

$$f = 30 \text{ Hz to } 15 \text{ kHz}$$

		JC559	JC560	
F	typ.	1.2	1	dB
	max.	4	3	dB

$$f = 1 \text{ kHz}; B = 200 \text{ Hz}$$

F	typ.	1	1	dB
	max.	4	4	dB

Equivalent noise voltage at  $R_S = 2 \text{ k}\Omega$ 

$$-I_C = 200 \mu\text{A}; -V_{CE} = 5 \text{ V}$$

$$f = 10 \text{ Hz to } 50 \text{ Hz}; T_{amb} = 25 \text{ }^\circ\text{C}$$

 $V_n$  max. 0.11  $\mu\text{V}$ 

DC current gain

$$-I_C = 2 \text{ mA}; -V_{CE} = 5 \text{ V}$$

		JC559 JC560	JC559A JC560A	JC559B JC560B	JC559C JC560C
$h_{FE}$	min.	125	125	220	420
	max.	800	250	475	800

**Note**

For characteristics drawings, see BC559/560, Figs 2 to 18.





## SILICON PLANAR EPITAXIAL TRANSISTOR

NPN transistor in a plastic TO-92 variant intended for HF applications in radio and television receivers; it is especially recommended for FM tuners, low noise AM mixer-oscillators with high source impedance and IF amplifiers in AM/FM receivers where a high current gain is of importance.

### QUICK REFERENCE DATA

Collector-base voltage (open emitter)	$V_{CBO}$	max.	30 V
Collector-emitter voltage (open base)	$V_{CEO}$	max.	20 V
Collector current (DC)	$I_C$	max.	30 mA
Total power dissipation up to $T_{amb} = 25\text{ }^\circ\text{C}$	$P_{tot}$	max.	300 mW
Junction temperature	$T_j$	max.	150 $^\circ\text{C}$
DC current gain $I_C = 1\text{ mA}; V_{CE} = 10\text{ V}$	$h_{FE}$		67 to 220
Transition frequency $I_C = 1\text{ mA}; V_{CE} = 10\text{ V}$	$f_T$	min. typ.	120 MHz 260 MHz

### MECHANICAL DATA

Dimensions in mm

Fig.1 TO-92.

#### Pinning:

- 1 = base
- 2 = collector
- 3 = emitter

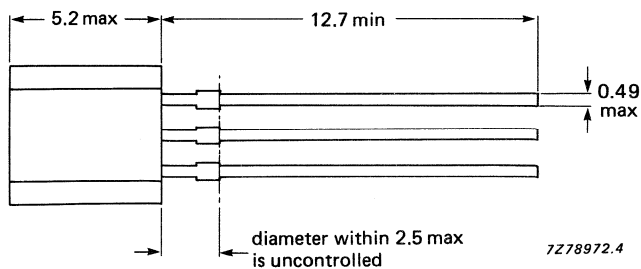
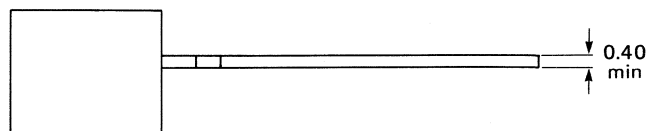
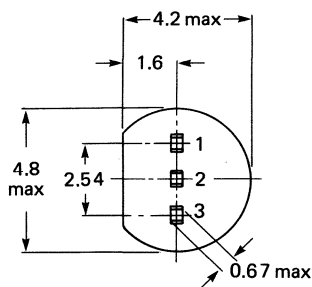
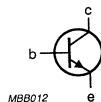

**RATINGS**

Limiting values in accordance with the Absolute Maximum System (IEC 134)

Collector-base voltage (open emitter)	$V_{CBO}$	max.	30 V
Collector-emitter voltage (open base)	$V_{CEO}$	max.	20 V
Emitter-base voltage (open collector)	$V_{EBO}$	max.	5 V
Collector current (DC)	$I_C$	max.	30 mA
Collector current (peak value)	$I_{CM}$	max.	30 mA
Total power dissipation up to $T_{amb} = 25\text{ }^\circ\text{C}$	$P_{tot}$	max.	300 mW
Storage temperature range	$T_{stg}$		-65 to + 150 $^\circ\text{C}$
Junction temperature	$T_j$	max.	150 $^\circ\text{C}$

**THERMAL RESISTANCE**

From junction to ambient in free air	$R_{th\ j-a}$	=	420 K/W
--------------------------------------	---------------	---	---------

**CHARACTERISTICS**

$T_{amb} = 25\text{ }^\circ\text{C}$  unless otherwise specified

Base-emitter voltage $I_C = 1\text{ mA}; V_{CE} = 10\text{ V}$		$V_{BE}$	0.65 to 0.74 V
DC current gain $I_C = 1\text{ mA}; V_{CE} = 10\text{ V}$	JF494	$h_{FE}$	67 to 220
Feedback capacitance at $f = 0.45\text{ MHz}$ $I_C = 1\text{ mA}; V_{CE} = 10\text{ V}$		$C_{re}$	max. 1 pF
Transition frequency $I_C = 1\text{ mA}; V_{CE} = 10\text{ V}$		$f_T$	min. 120 MHz typ. 260 MHz
Collector cut-off current $I_E = 0; V_{CB} = 20\text{ V}$		$I_{CBO}$	max. 100 nA
$I_E = 0; V_{CB} = 20\text{ V}; T_{amb} = 150\text{ }^\circ\text{C}$		$I_{CBO}$	max. 4 $\mu\text{A}$
Emitter-base cut-off current $I_C = 0; V_{EB} = 4\text{ V}$		$I_{EBO}$	max. 100 nA





## SILICON PLANAR EPITAXIAL TRANSISTORS

PNP silicon planar epitaxial transistors, each in a plastic TO-92 envelope.  
They are intended for use in amplifier applications.

### QUICK REFERENCE DATA

			MPS3702	MPS3703
Collector-emitter voltage (open base)	$-V_{CEO}$	max.	25	30 V
Collector-base voltage (open emitter)	$-V_{CBO}$	max.	40	50 V
Collector current (DC)	$-I_C$	max.	600	mA
Total power dissipation at $T_{amb} \leq 25^\circ\text{C}$	$P_{tot}$	max.	625	mW
Collector-emitter saturation voltage $-I_C = 50\text{ mA}; -I_B = 5\text{ mA}$	$-V_{CEsat}$	max.	0.25	V
DC current gain $-I_C = 50\text{ mA}; -V_{CE} = 5\text{ V}$	hFE	min.	60	30
		max.	300	150

### MECHANICAL DATA

Dimensions in mm

Fig. 1 TO-92.

#### Pinning

- 1 = collector
- 2 = base
- 3 = emitter

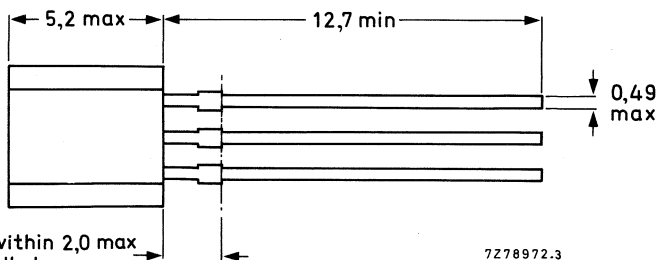
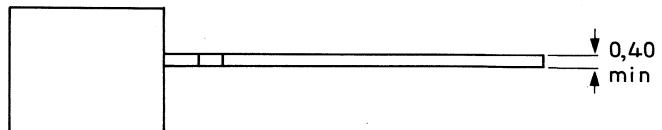
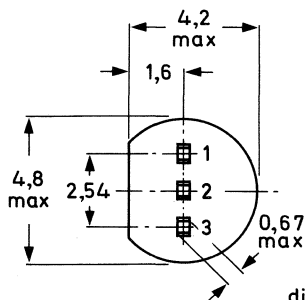
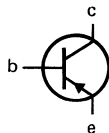

diameter within 2,0 max  
is uncontrolled

7278972.3

**RATINGS**

Limiting values in accordance with the Absolute Maximum System (IEC 134)

			MPS3702	MPS3703
Collector-emitter voltage (open base)	$-V_{CEO}$	max.	25	30 V
Collector-base voltage (open emitter)	$-V_{CBO}$	max.	40	50 V
Emitter-base voltage (open collector)	$-V_{EBO}$	max.	5	V
Collector current (DC)	$-I_C$	max.	600	mA
Total power dissipation at $T_{amb} \leq 25^\circ\text{C}$	$P_{tot}$	max.	625	mW
Storage temperature range	$T_{stg}$		-65 to +150	$^\circ\text{C}$

**THERMAL RESISTANCE**

From junction to ambient in free air	$R_{th\ j-a}$	=	200	K/W
--------------------------------------	---------------	---	-----	-----

**CHARACTERISTICS**

$T_j = 25^\circ\text{C}$  unless otherwise specified

			MPS3702	MPS3703
Collector-emitter breakdown voltage $I_B = 0; -I_C = 10\text{ mA}$	$-V_{(BR)CEO}$	min.	25	30 V
Collector-base breakdown voltage $-I_C = 100\ \mu\text{A}; I_E = 0$	$-V_{(BR)CBO}$	min.	40	50 V
Emitter-base breakdown voltage $-I_E = 100\ \mu\text{A}; I_C = 0$	$-V_{(BR)EBO}$	min.	5	V
Collector cut-off current $I_E = 0; -V_{CB} = 20\text{ V}$	$-I_{CBO}$	max.	100	nA
Emitter cut-off current $I_C = 0; -V_{EB} = 3\text{ V}$	$-I_{EBO}$	max.	100	nA
DC current gain $-I_C = 50\text{ mA}; -V_{CE} = 5\text{ V}$	$h_{FE}$	min. max.	60 300	30 150
Base-emitter on-state voltage $-I_C = 50\text{ mA}; -V_{CE} = 5\text{ V}$	$-V_{BE(on)}$	min. max.	0.6 -	- V 0.1 V
Collector-emitter saturation voltage $-I_C = 50\text{ mA}; -I_B = 5\text{ mA}$	$-V_{CEsat}$	min.	0.25	V
Transition frequency at $f = 100\text{ MHz}$ $-I_C = 50\text{ mA}; -V_{CE} = 5\text{ V}$	$f_T$	min.	100	MHz
Collector-base capacitance at $f = 1\text{ MHz}$ $I_E = 0; -V_{CB} = 10\text{ V}$	$C_{ob}$	max.	12	pF



## SILICON PLANAR EPITAXIAL TRANSISTORS

NPN silicon planar epitaxial transistors, each in a plastic TO-92 envelope.  
They are intended for use in amplifier applications.

### QUICK REFERENCE DATA

		MPS3704	05	06
Collector-emitter voltage (open base)	$V_{CEO}$	max. 30	30	20 V
Collector-base voltage (open emitter)	$V_{CBO}$	max. 50	50	40 V
Collector current (DC)	$I_C$	max.	600	mA
Total power dissipation at $T_{amb} \leq 25^\circ C$	$P_{tot}$	max.	625	mW
Collector-emitter saturation voltage $I_C = 100\text{ mA}; I_B = 5\text{ mA}$	$V_{CEsat}$	min. 0.6	0.8	1.0 V
DC current gain $I_C = 50\text{ mA}; V_{CE} = 5\text{ V}$	$h_{FE}$	min. 100 max. 300	50 150	30 600

### MECHANICAL DATA

Dimensions in mm

Fig. 1 TO-92.

#### Pinning

- 1 = collector
- 2 = base
- 3 = emitter

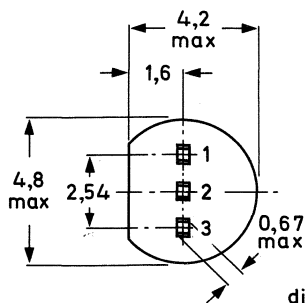
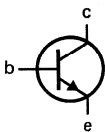

diameter within 2,0 max  
is uncontrolled

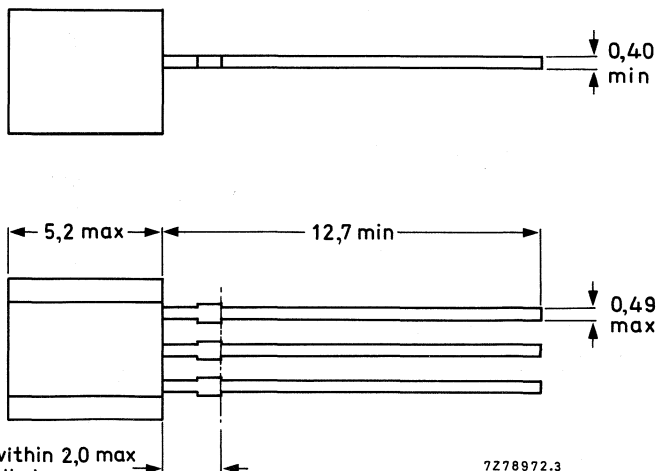

7278972.3

### RATINGS

Limiting values in accordance with the Absolute Maximum System (IEC 134)

		MPS3704	05	06	
Collector-emitter voltage (open base)	$V_{CEO}$	max. 30	30	20	V
Collector-base voltage (open emitter)	$V_{CBO}$	max. 50	50	40	V
Emitter-base voltage (open collector)	$V_{EBO}$	max.	5		V
Collector current (DC)	$I_C$	max.	600		mA
Total power dissipation at $T_{amb} \leq 25^\circ\text{C}$	$P_{tot}$	max.	625		mW
Storage temperature range	$T_{stg}$		-65 to +150		$^\circ\text{C}$

### THERMAL RESISTANCE

From junction to ambient in free air	$R_{thj-a}$	=	200		K/W
--------------------------------------	-------------	---	-----	--	-----

### CHARACTERISTICS

$T_j = 25^\circ\text{C}$  unless otherwise specified

		MPS3704	05	06	
Collector-emitter breakdown voltage $I_B = 0; I_C = 10\text{ mA}$	$V_{(BR)CEO}$	min. 30	30	20	V
Collector-base breakdown voltage $I_C = 100\ \mu\text{A}; I_E = 0$	$V_{(BR)CBO}$	min. 50	50	40	V
Emitter-base breakdown voltage $I_C = 0; I_E = 100\ \mu\text{A}$	$V_{(BR)EBO}$	min.	5		V
Collector cut-off current $I_E = 0; V_{CB} = 20\text{ V}$	$I_{CBO}$	max.	100		nA
Emitter cut-off current $I_C = 0; V_{EB} = 3\text{ V}$	$I_{EBO}$	max.	100		nA
DC current gain $I_C = 50\text{ mA}; V_{CE} = 5\text{ V}$	$h_{FE}$	min. 100 max. 300	50 150	30 600	
Collector-emitter saturation voltage $I_C = 100\text{ mA}; I_B = 5\text{ mA}$	$V_{CEsat}$	max. 0.6	0.8	1.0	V
Base-emitter on-state voltage $I_C = 100\text{ mA}; V_{CE} = 5\text{ V}$	$V_{BE(on)}$	min. max.	0.5 1.0		V
Transition frequency at $f = 100\text{ MHz}$ $I_C = 50\text{ mA}; V_{CE} = 5\text{ V}$	$f_T$	min.	100		MHz
Collector-base capacitance at $f = 1\text{ MHz}$ $I_E = 0; V_{CB} = 10\text{ V}$	$C_{ob}$	max.	12		pF



## SILICON PLANAR EPITAXIAL TRANSISTOR

NPN transistors in plastic TO-92 envelopes, primarily intended for industrial applications (e.g. Telecom).

### QUICK REFERENCE DATA

Collector-base voltage (open emitter)	$V_{CBO}$	max.	60 V
Collector-emitter voltage (open base)	$V_{CEO}$	max.	40 V
Collector current (DC)	$I_C$	max.	200 mA
Total power dissipation at $T_{amb} = 25\text{ }^\circ\text{C}$	$P_{tot}$	max.	500 mW
DC current gain	$h_{FE}$	min.	100
$I_C = 10\text{ mA}; V_{CE} = 1\text{ V}$		max.	300
Transition frequency at $f = 100\text{ MHz}$	$f_T$	min.	180 MHz
$I_C = 10\text{ mA}; V_{CE} = 20\text{ V}$			

### MECHANICAL DATA

Dimensions in mm

Fig. 1 TO-92.

#### Pinning

- 1 = collector
- 2 = base
- 3 = emitter

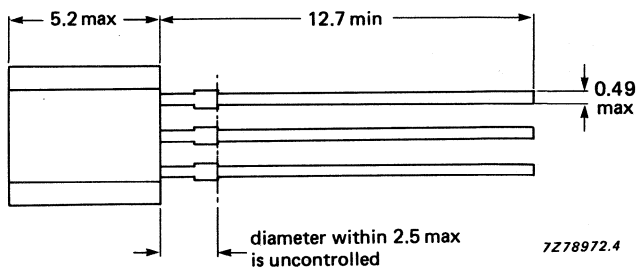
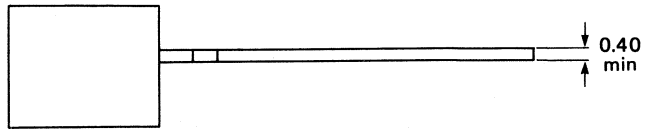
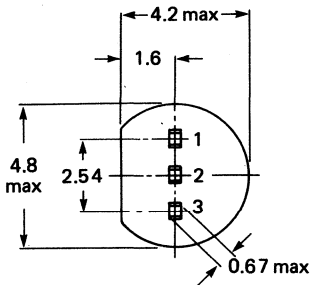
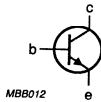

**RATINGS**

Limiting values in accordance with the Absolute Maximum System (IEC 134).

Collector-base voltage (open emitter)	$V_{CBO}$	max.	60 V
Collector-emitter voltage (open base)	$V_{CEO}$	max.	40 V
Emitter-base voltage (open collector)	$V_{EBO}$	max.	6 V
Collector current (DC)	$I_C$	max.	200 mA
Total power dissipation at $T_{amb} = 25\text{ }^\circ\text{C}$	$P_{tot}$	max.	500 mW
Storage temperature range	$T_{stg}$		-65 to +150 $^\circ\text{C}$
Junction temperature	$T_j$	max.	150 $^\circ\text{C}$

**THERMAL RESISTANCE**

From junction to ambient in free air	$R_{th\ j-a}$	=	250 K/W
--------------------------------------	---------------	---	---------

**CHARACTERISTICS** $T_{amb} = 25\text{ }^\circ\text{C}$ 

Currents at reverse biased emitter junction

 $V_{CE} = 30\text{ V}; -V_{BE} = 3\text{ V}$ 

$I_{CEX}$	max.	50 nA
$-I_{BEX}$	max.	50 nA

Saturation voltages (see note 1)

 $I_C = 10\text{ mA}; I_B = 1\text{ mA}$ 

$V_{CEsat}$	max.	200 mV
$V_{BEsat}$		650 to 850 mV

 $I_C = 50\text{ mA}; I_B = 5\text{ mA}$ 

$V_{CEsat}$	max.	300 mV
$V_{BEsat}$	max.	950 mV

DC current gain (see note 1)

 $I_C = 0.1\text{ mA}; V_{CE} = 1\text{ V}$  $I_C = 1\text{ mA}; V_{CE} = 1\text{ V}$ 

$h_{FE}$	min.	40
$h_{FE}$	min.	70

 $I_C = 10\text{ mA}; V_{CE} = 1\text{ V}$ 

$h_{FE}$	min.	100
$h_{FE}$	max.	300

 $I_C = 50\text{ mA}; V_{CE} = 1\text{ V}$  $I_C = 100\text{ mA}; V_{CE} = 1\text{ V}$ 

$h_{FE}$	min.	60
$h_{FE}$	min.	30

Collector capacitance at  $100\text{ kHz} \leq f \leq 1\text{ MHz}$  $I_E = I_e = 0; V_{CB} = 5\text{ V}$ 

$C_c$	max.	5 pF
-------	------	------

Emitter capacitance at  $100\text{ kHz} \leq f \leq 1\text{ MHz}$  $I_C = I_c = 0; V_{EB} = 0.5\text{ V}$ 

$C_e$	max.	15 pF
-------	------	-------

Transition frequency at  $f = 100\text{ MHz}$  $I_C = 10\text{ mA}; V_{CE} = 20\text{ V}$ 

$f_T$	min.	180 MHz
-------	------	---------

Noise figure at  $R_S = 1\text{ k}\Omega$  $I_C = 100\text{ }\mu\text{A}; V_{CE} = 5\text{ V}$  $f = 10\text{ Hz to }15.7\text{ kHz}$ 

F	max.	5 dB
---	------	------

**Note**1. Measured under pulse conditions:  $t_p = 300\text{ }\mu\text{s}; \delta = 0.02$ .

## SWITCHING CHARACTERISTICS

## Delay time

$V_{CC} = 3.0 \text{ V DC}$ ,  $V_{BE(\text{off})} = 0.5 \text{ V DC}$   
 $I_C = 10 \text{ mA DC}$ ,  $I_{B1} = 1 \text{ mA DC}$

$t_d$  max. 45 ns

## Rise time

$V_{CC} = 3.0 \text{ V DC}$ ,  $V_{BE(\text{off})} = 0.5 \text{ V DC}$   
 $I_C = 10 \text{ mA DC}$ ,  $I_{B1} = 1 \text{ mA DC}$

$t_r$  max. 55 ns

## Storage time

$V_{CC} = 3.0 \text{ V DC}$ ,  $I_C = 10 \text{ mA DC}$   
 $I_{B1} = I_{B2} = 1 \text{ mA DC}$

$t_{\text{stg}}$  max. 900 ns

## Fall time

$V_{CC} = 3.0 \text{ V DC}$ ,  $I_C = 10 \text{ mA DC}$   
 $I_{B1} = I_{B2} = 1 \text{ mA DC}$

$t_f$  max. 90 ns

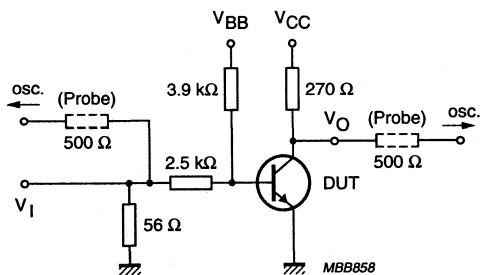

Fig. 2 Test circuit for switching times;  
 $V_1 = 5 \text{ V}$ ;  $t_p \geq 4 \mu\text{s}$ ;  $t_r = t_f \leq 3 \text{ ns}$ .







## SILICON PLANAR EPITAXIAL TRANSISTOR

PNP transistors in plastic TO-92 envelopes, primarily intended for industrial applications (e.g. Telecom).

### QUICK REFERENCE DATA

Collector-base voltage (open emitter)	$-V_{CBO}$	max.	40 V
Collector-emitter voltage (open base)	$-V_{CEO}$	max.	40 V
Collector current (DC)	$-I_C$	max.	200 mA
Total power dissipation at $T_{amb} = 25\text{ }^{\circ}\text{C}$	$P_{tot}$	max.	500 mW
DC current gain			
$-I_C = 10\text{ mA}; -V_{CE} = 1\text{ V}$	$h_{FE}$	min.	100
		max.	300
Transition frequency at $f = 100\text{ MHz}$			
$-I_C = 10\text{ mA}; -V_{CE} = 20\text{ V}$	$f_T$	min.	150 MHz

### MECHANICAL DATA

Dimensions in mm

Fig. 1 TO-92.

#### Pinning

- 1 = collector
- 2 = base
- 3 = emitter

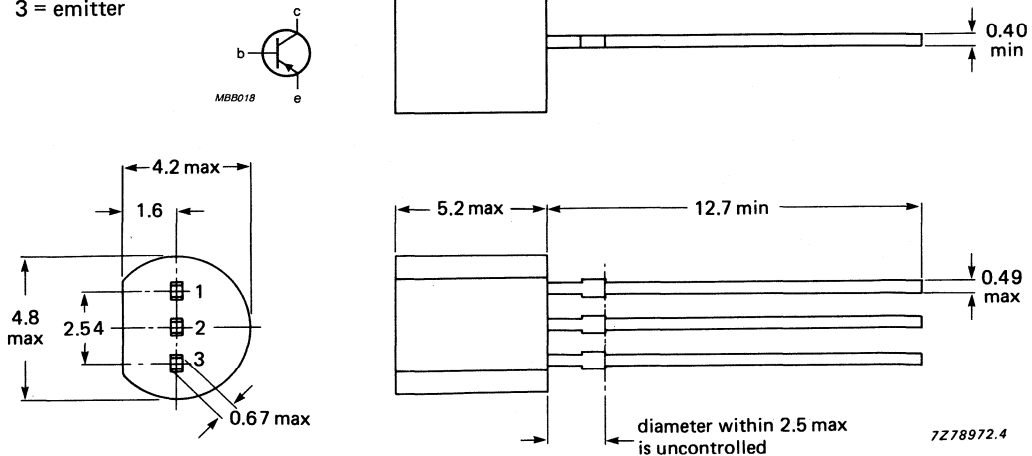

**RATINGS**

Limiting values in accordance with the Absolute Maximum System (IEC 134).

Collector-base voltage (open emitter)	$-V_{CBO}$	max.	40 V
Collector-emitter voltage (open base)	$-V_{CEO}$	max.	40 V
Emitter-base voltage (open collector)	$-V_{EBO}$	max.	5 V
Collector current (DC)	$-I_C$	max.	200 mA
Total power dissipation at $T_{amb} = 25\text{ }^\circ\text{C}$	$P_{tot}$	max.	500 mW
Storage temperature range	$T_{stg}$		-65 to +150 $^\circ\text{C}$
Junction temperature	$T_j$	max.	150 $^\circ\text{C}$

**THERMAL RESISTANCE**

From junction to ambient in free air	$R_{thj-a}$	=	250 K/W
--------------------------------------	-------------	---	---------

**CHARACTERISTICS** $T_{amb} = 25\text{ }^\circ\text{C}$ 

Currents at reverse biased emitter junction

 $-V_{CE} = 30\text{ V}; +V_{BE} = 3\text{ V}$ 

$-I_{CEX}$	max.	50 nA
$+I_{BEX}$	max.	50 nA

Saturation voltages (see note 1)

 $-I_C = 10\text{ mA}; -I_B = 1\text{ mA}$ 

$-V_{CEsat}$	max.	250 mV
$-V_{BEsat}$		650 to 850 mV

 $-I_C = 50\text{ mA}; -I_B = 5\text{ mA}$ 

$-V_{CEsat}$	max.	400 mV
$-V_{BEsat}$	max.	950 mV

DC current gain (see note 1)

 $-I_C = 0.1\text{ mA}; V_{CE} = 1\text{ V}$ 

$h_{FE}$	min.	60
----------	------	----

 $-I_C = 1\text{ mA}; V_{CE} = 1\text{ V}$ 

$h_{FE}$	min.	80
----------	------	----

 $-I_C = 10\text{ mA}; V_{CE} = 1\text{ V}$ 

$h_{FE}$	min.	100
$h_{FE}$	max.	300

 $-I_C = 50\text{ mA}; V_{CE} = 1\text{ V}$ 

$h_{FE}$	min.	60
----------	------	----

 $-I_C = 100\text{ mA}; V_{CE} = 1\text{ V}$ 

$h_{FE}$	min.	30
----------	------	----

Collector capacitance at  $100\text{ kHz} \leq f \leq 1\text{ MHz}$  $I_E = I_e = 0; -V_{CB} = 5\text{ V}$ 

$C_c$	max.	5 pF
-------	------	------

Emitter capacitance at  $100\text{ kHz} \leq f \leq 1\text{ MHz}$  $I_C = I_c = 0; -V_{EB} = 0.5\text{ V}$ 

$C_e$	max.	15 pF
-------	------	-------

Transition frequency at  $f = 100\text{ MHz}$  $-I_C = 10\text{ mA}; -V_{CE} = 20\text{ V}$ 

$f_T$	min.	150 MHz
-------	------	---------

Noise figure at  $R_S = 1\text{ k}\Omega$  $-I_C = 100\text{ }\mu\text{A}; -V_{CE} = 5\text{ V}$  $f = 10\text{ Hz to } 15.7\text{ kHz}$ 

F	max.	4 dB
---	------	------

**Note**1. Measured under pulse conditions:  $t_p = 300\text{ }\mu\text{s}; \delta = 0.02$ .

## SWITCHING CHARACTERISTICS

## Delay time

$V_{CC} = 3.0 \text{ V DC}$ ,  $V_{BE(\text{off})} = 0.5 \text{ V DC}$   
 $I_C = 10 \text{ mA DC}$ ,  $I_{B1} = 1 \text{ mA DC}$

$t_d$  max. 45 ns

## Rise time

$V_{CC} = 3.0 \text{ V DC}$ ,  $V_{BE(\text{off})} = 0.5 \text{ V DC}$   
 $I_C = 10 \text{ mA DC}$ ,  $I_{B1} = 1 \text{ mA DC}$

$t_r$  max. 55 ns

## Storage time

$V_{CC} = 3.0 \text{ V DC}$ ,  $I_C = 10 \text{ mA DC}$   
 $I_{B1} = I_{B2} = 1 \text{ mA DC}$

$t_{stg}$  max. 600 ns

## Fall time

$V_{CC} = 3.0 \text{ V DC}$ ,  $I_C = 10 \text{ mA DC}$   
 $I_{B1} = I_{B2} = 1 \text{ mA DC}$

$t_f$  max. 90 ns

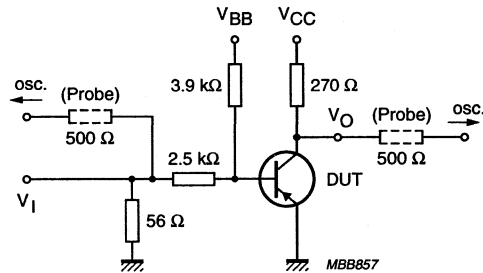

Fig. 2 Test circuit for switching times;  
 $V_1 = -5 \text{ V}$ ;  $t_p \geq 4 \mu\text{s}$ ;  $t_r = t_f \leq 3 \text{ ns}$ .





## AMPLIFIER TRANSISTOR

General purpose n-p-n transistors in TO-92 envelopes. The complementary types are MPS6517 to MPS6519.

### QUICK REFERENCE DATA

		MPS6513	6514	6515
Collector-emitter voltage	$V_{CE0}$ max.	30	25	25 V
Collector current (d.c.)	$I_C$ max.	100	100	100 mA
D.C. current gain $I_C = 100$ mA; $V_{CE} = 10$ V	$h_{FE}$ >	60	90	150
Total power dissipation up to $T_{amb} = 25$ °C	$P_{tot}$ max.	625		mW

### MECHANICAL DATA

Dimensions in mm

Fig. 1 TO-92.

Pinning;

- 1 = collector
- 2 = base
- 3 = emitter

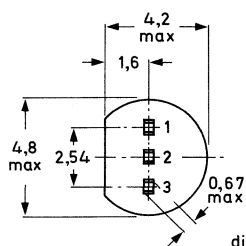
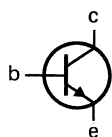

diameter within 2,0 max  
is uncontrolled

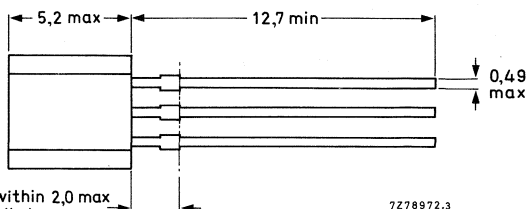
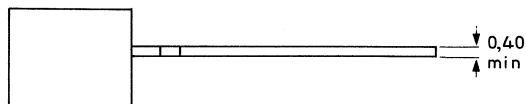

7278972.3

### RATINGS

Limiting values in accordance with the Absolute Maximum System (IEC 134)

		MPS6513	6514	6515
Collector-emitter voltage	$V_{CEO}$ max.	30	25	25 V
Collector-base voltage	$V_{CBO}$ max.	40		V
Emitter-base voltage	$V_{EBO}$ max.	4,0		V
Collector current (d.c.)	$I_C$ max.	100		mA
Total power dissipation up to $T_{amb} = 25\text{ }^\circ\text{C}$	$P_{tot}$ max.	625		mW
Storage temperature range	$T_{stg}$	-65 to +150		$^\circ\text{C}$
Junction temperature	$T_j$ max.	150		$^\circ\text{C}$

### THERMAL RESISTANCE

From junction to ambient in free air	$R_{th\ j-a}$ =	200	K/W
--------------------------------------	-----------------	-----	-----

### CHARACTERISTICS

$T_j = 25\text{ }^\circ\text{C}$  unless otherwise specified

		MPS6513	6514	6515
Collector-emitter breakdown voltage $I_C = 0,5\text{ mA}; I_B = 0$	$V_{(BR)CEO} >$	30	25	25 V
Emitter-base breakdown voltage $I_E = 10\text{ }\mu\text{A}; I_C = 0$	$V_{(BR)EBO} >$	4,0	4,0	4,0 V
Collector cut-off current $V_{CB} = 30\text{ V}; I_E = 0$	$I_{CBO} <$	50	50	50 nA
D.C. current gain $I_C = 2\text{ mA}; V_{CE} = 10\text{ V}$	$h_{FE} =$	90 to 180	150 to 300	250 to 500
$I_C = 100\text{ mA}; V_{CE} = 10\text{ V}$	$h_{FE} >$	60	90	150
Collector-emitter saturation voltage $I_C = 50\text{ mA}; I_B = 5\text{ mA}$	$V_{CEsat} <$	0,5		V
Output capacitance $V_{CB} = 10\text{ V}; I_E = 0; f = 100\text{ kHz}$	$C_{obo} <$	3,5		pF



## AMPLIFIER TRANSISTOR

General purpose p-n-p transistors in TO-92 envelopes. The complementary types are MPS6513 to MPS6515.

### QUICK REFERENCE DATA

			MPS6517	6518	6519
Collector-emitter voltage	$-V_{CE0}$	max.	40	40	25 V
Collector current (d.c.)	$-I_C$	max.	100	100	100 mA
D.C. current gain	$h_{FE}$	>	60	90	150
Total power dissipation up to $T_{amb} = 25\text{ }^{\circ}\text{C}$	$P_{tot}$	max.	625		mW

### MECHANICAL DATA

Dimensions in mm

Fig. 1 TO-92.

Pinning;

- 1 = collector
- 2 = base
- 3 = emitter

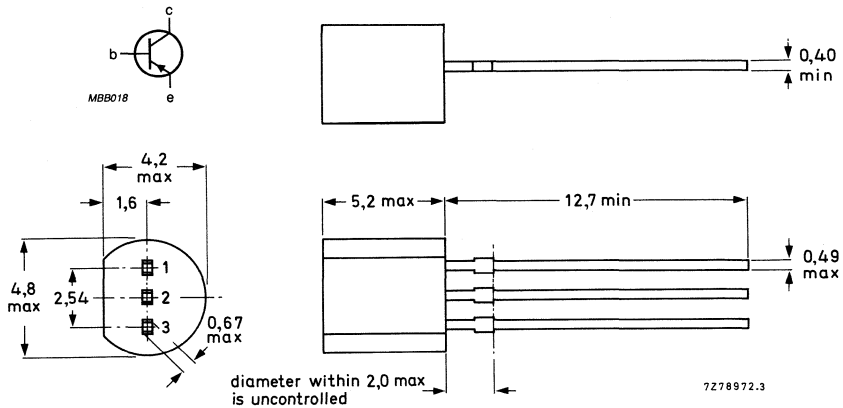

### RATINGS

Limiting values in accordance with the Absolute Maximum System (IEC 134)

			MPS6517	6518	6519
Collector-emitter voltage	$-V_{CEO}$	max.	40	40	25 V
Collector-base voltage	$-V_{CBO}$	max.	40	40	25 V
Emitter-base voltage	$-V_{EBO}$	max.	4,0		V
Collector current (d.c.)	$-I_C$	max.	100		mA
Total power dissipation up to $T_{amb} = 25\text{ }^{\circ}\text{C}$	$P_{tot}$	max.	625		mW
Storage temperature range	$T_{stg}$		-65 to +150		$^{\circ}\text{C}$
Junction temperature	$T_j$	max.	150		$^{\circ}\text{C}$

### THERMAL RESISTANCE

From junction to ambient in free air	$R_{th\ j-a}$	=	200	K/W
--------------------------------------	---------------	---	-----	-----

### CHARACTERISTICS

$T_j = 25\text{ }^{\circ}\text{C}$  unless otherwise specified

			MPS6517	6518	6519
Collector-emitter breakdown voltage $-I_C = 0,5\text{ mA}; I_B = 0$	$-V_{(BR)CEO}$	>	40	40	25 V
Emitter-base breakdown voltage $-I_E = 10\text{ }\mu\text{A}; I_C = 0$	$-V_{(BR)EBO}$	>	4,0	4,0	4,0 V
Collector cut-off current $-V_{CB} = 30\text{ V}; I_E = 0$ $-V_{CB} = 20\text{ V}; I_E = 0$	$-I_{CBO}$ $-I_{CBO}$	< <	50 -	50 -	- nA 50 nA
D.C. current gain $-I_C = 2\text{ mA}; -V_{CE} = 10\text{ V}$	$h_{FE}$	=	90 to 180	150 to 300	250 to 500
$-I_C = 100\text{ mA}; -V_{CE} = 10\text{ V}$	$h_{FE}$	>	60	90	150
Collector-emitter saturation voltage $-I_C = 50\text{ mA}; -I_B = 5\text{ mA}$	$-V_{CEsat}$	<	0,5		V
Output capacitance $-V_{CB} = 10\text{ V}; I_E = 0; f = 100\text{ kHz}$	$C_{obo}$	<	3,5		pF





## SILICON PLANAR EPITAXIAL TRANSISTORS

N-P-N small-signal transistors in plastic TO-92 envelope intended for low-noise applications in audio equipment.

Complementary types are MPS6522 and MPS6523.

### QUICK REFERENCE DATA

Collector-emitter voltage (open base)	$V_{CEO}$	max.	25	V
Collector-base voltage (open emitter)	$V_{CBO}$	max.	40	V
Collector current (d.c.)	$I_C$	max.	100	mA
Total device dissipation up to $T_{amb} = 25\text{ }^\circ\text{C}$	$P_{tot}$	max.	625	mW
Collector-emitter saturation voltage $I_C = 50\text{ mA}; I_B = 5\text{ mA}$	$V_{CEsat}$	max.	0,5	V
			MPS6520	MPS6521
D.C. current gain $I_C = 100\text{ }\mu\text{A}; V_{CE} = 10\text{ V}$	$h_{FE}$	min.	100	150
$I_C = 2\text{ mA}; V_{CE} = 10\text{ V}$	$h_{FE}$	min.	200	300
		max.	400	600

### MECHANICAL DATA

Dimensions in mm

Fig. 1 TO-92.

#### Pinning

- 1 = collector
- 2 = base
- 3 = emitter

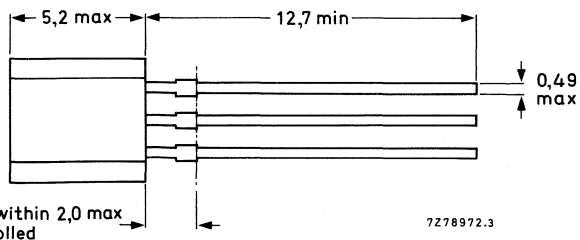
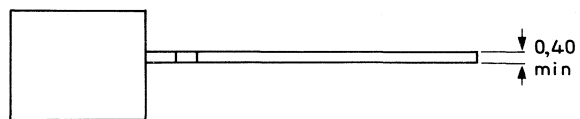
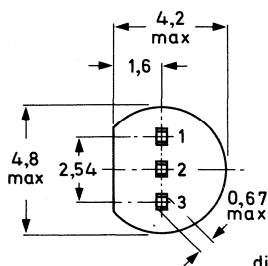
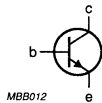

**RATINGS**

Limiting values in accordance with the Absolute Maximum System (IEC 134)

Collector-emitter voltage (open base)	$V_{CEO}$	max.	25	V
Collector-base voltage (open emitter)	$V_{CBO}$	max.	40	V
Emitter-base voltage (open collector)	$V_{EBO}$	max.	4,0	V
Collector current (d.c.)	$I_C$	max.	100	mA
Total device dissipation up to $T_{amb} = 25\text{ }^\circ\text{C}$	$P_{tot}$	max.	625	mW
Storage temperature range	$T_{stg}$		-65 to +150	$^\circ\text{C}$
Junction temperature	$T_j$	max.	150	$^\circ\text{C}$

**THERMAL RESISTANCE**

From junction to ambient in free air	$R_{th\ j-a}$	=	200	K/W
--------------------------------------	---------------	---	-----	-----

**CHARACTERISTICS**

$T_j = 25\text{ }^\circ\text{C}$  unless otherwise specified

Collector-emitter breakdown voltage $I_B = 0; I_C = 0,5\text{ mA}$	$V_{(BR)CEO}$	min.	25	V
Emitter-base breakdown voltage $I_E = 10\text{ }\mu\text{A}; I_C = 0$	$V_{(BR)EBO}$	min.	4,0	V
Collector cut-off current $V_{CB} = 30\text{ V}; I_E = 0$	$I_{CBO}$	max.	50	nA
Collector-emitter saturation voltage $I_C = 50\text{ mA}; I_B = 5\text{ mA}$	$V_{CEsat}$	max.	0,5	V
Output capacitance at $f = 100\text{ kHz}$ $V_{CB} = 10\text{ V}; I_E = 0$	$C_o$	max.	3,5	pF
Noise figure at $T_{amb} = 25\text{ }^\circ\text{C}$ $I_C = 10\text{ }\mu\text{A}; V_{CE} = 5\text{ V};$ $R_S = 10\text{ k}\Omega; f = 10\text{ Hz to }10\text{ kHz}$	F	max.	3,0	dB
D.C. current gain $I_C = 100\text{ }\mu\text{A}; V_{CE} = 10\text{ V}$	$h_{FE}$	min.	100	150
$I_C = 2\text{ mA}; V_{CE} = 10\text{ V}$	$h_{FE}$	min.	200	300
		max.	400	600

	MPS6520	MPS6521
--	---------	---------



## SILICON PLANAR EPITAXIAL TRANSISTORS

P-N-P small-signal transistors in plastic TO-92 envelope intended for low-noise applications in audio equipment.

Complementary types are MPS6520 and MPS6521.

### QUICK REFERENCE DATA

Collector-emitter voltage (open base)	$-V_{CEO}$	max.	25	V
Collector-base voltage (open emitter)	$-V_{CBO}$	max.	25	V
Collector current (d.c.)	$-I_C$	max.	100	mA
Total device dissipation up to $T_{amb} = 25\text{ }^\circ\text{C}$	$P_{tot}$	max.	625	mW
Collector-emitter saturation voltage $-I_C = 50\text{ mA}; -I_B = 5\text{ mA}$	$-V_{CEsat}$	max.	0,5	V
<b>MPS6522   MPS6523</b>				
D.C. current gain $-I_C = 100\text{ }\mu\text{A}; -V_{CE} = 10\text{ V}$	$h_{FE}$	min.	100	150
	$h_{FE}$	max.	400	600

### MECHANICAL DATA

Dimensions in mm

Fig. 1 TO-92.

#### Pinning

- 1 = collector
- 2 = base
- 3 = emitter

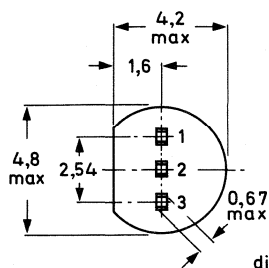
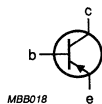

diameter within 2,0 max  
is uncontrolled

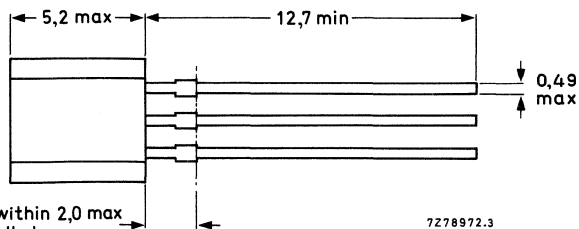
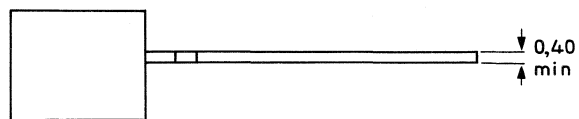

7278972.3

### RATINGS

Limiting values in accordance with the Absolute Maximum System (IEC 134)

Collector-emitter voltage (open base)	$-V_{CEO}$	max.	25	V
Collector-base voltage (open emitter)	$-V_{CBO}$	max.	25	V
Emitter-base voltage (open collector)	$-V_{EBO}$	max.	4,0	V
Collector current (d.c.)	$-I_C$	max.	100	mA
Total device dissipation up to $T_{amb} = 25\text{ }^{\circ}\text{C}$	$P_{tot}$	max.	625	mW
Storage temperature range	$T_{stg}$		-65 to +150	$^{\circ}\text{C}$
Junction temperature	$T_j$	max.	150	$^{\circ}\text{C}$

### THERMAL RESISTANCE

From junction to ambient in free air	$R_{th\ j-a}$	=	200	K/W
--------------------------------------	---------------	---	-----	-----

### CHARACTERISTICS

$T_j = 25\text{ }^{\circ}\text{C}$  unless otherwise specified

Collector-emitter breakdown voltage $I_B = 0; -I_C = 0,5\text{ mA}$	$-V_{(BR)CEO}$	min.	25	V
Emitter-base breakdown voltage $-I_E = 10\text{ }\mu\text{A}; I_C = 0$	$-V_{(BR)EBO}$	min.	4,0	V
Collector cut-off current $-V_{CB} = 30\text{ V}; I_E = 0$	$-I_{CBO}$	max.	50	nA
Collector-emitter saturation voltage $-I_C = 50\text{ mA}; -I_B = 5\text{ mA}$	$-V_{CEsat}$	max.	0,5	V
Output capacitance at $f = 100\text{ kHz}$ $-V_{CB} = 10\text{ V}; I_E = 0$	$C_o$	max.	3,5	pF
Noise figure at $T_{amb} = 25\text{ }^{\circ}\text{C}$ $-I_C = 10\text{ }\mu\text{A}; -V_{CE} = 5\text{ V};$ $R_S = 10\text{ k}\Omega; f = 10\text{ Hz to }10\text{ kHz}$	F	max.	3,0	dB
D.C. current gain $-I_C = 100\text{ }\mu\text{A}; -V_{CE} = 10\text{ V}$	$h_{FE}$	min.	100	150
$-I_C = 2\text{ mA}; -V_{CE} = 10\text{ V}$	$h_{FE}$	min. max.	200 400	300 600

	MPS6522	MPS6523
--	---------	---------



## SILICON PLANAR EPITAXIAL TRANSISTORS

NPN silicon planar epitaxial small-signal transistors, each in a plastic TO-92 envelope.

They are intended for amplifier applications.

PNP complementary types are MPS6534 and MPS6535.

### QUICK REFERENCE DATA

			MPS6531	MPS6532	
Collector-emitter voltage (open base)	$V_{CE0}$	max.	40	30	V
Collector-base voltage (open emitter)	$V_{CB0}$	max.	60	50	V
DC collector current	$I_C$	max.	600		mA
Total power dissipation at $T_{amb} = 25\text{ }^\circ\text{C}$	$P_{tot}$	max.	625		mW
Collector-emitter saturation voltage $I_C = 100\text{ mA}; I_B = 10\text{ mA}$	$V_{CEsat}$	max.	0.3	0.5	V
DC current gain $I_C = 100\text{ mA}; V_{CE} = 1\text{ V}$	$h_{FE}$	min.	90	30	
		max.	270	—	

### MECHANICAL DATA

Dimensions in mm

#### Pinning

1 = collector

2 = base

3 = emitter

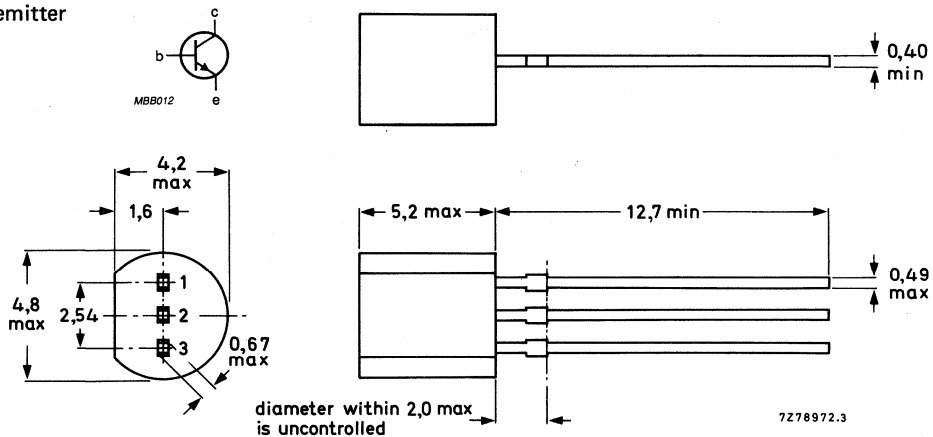

Fig. 1 TO-92.

### RATINGS

Limiting values in accordance with the Absolute Maximum System (IEC 134)

			MPS6531	MPS6532	
Collector-emitter voltage (open base)	$V_{CEO}$	max.	40	30	V
Collector-base voltage (open emitter)	$V_{CBO}$	max.	60	50	V
Emitter-base voltage (open collector)	$V_{EBO}$	max.	5.0		V
DC collector current	$I_C$	max.	600		mA
Total power dissipation at $T_{amb} = 25\text{ }^\circ\text{C}$	$P_{tot}$	max.	625		mW
Storage temperature range	$T_{stg}$		-65 to + 150		$^\circ\text{C}$
Junction temperature	$T_j$	=	150		$^\circ\text{C}$

### CHARACTERISTICS

$T_j = 25\text{ }^\circ\text{C}$  unless otherwise specified

			MPS6531	MPS6532	
Collector-emitter breakdown voltage $I_B = 0; I_C = 10\text{ mA}$	$V_{(BR)CEO}$	min.	40	30	V
Collector-base breakdown voltage $I_E = 0; I_C = 10\text{ }\mu\text{A}$	$V_{(BR)CBO}$	min.	60	50	V
Collector cut-off currents $I_E = 0; V_{CB} = 40\text{ V}$	$I_{CBO}$	max.	50	—	nA
$I_E = 0; V_{CB} = 30\text{ V}$	$I_{CBO}$	max.	—	100	nA
$I_E = 0; V_{CB} = 40\text{ V}; T_{amb} = 60\text{ }^\circ\text{C}$	$I_{CBO}$	max.	2	—	$\mu\text{A}$
$I_E = 0; V_{CB} = 30\text{ V}; T_{amb} = 60\text{ }^\circ\text{C}$	$I_{CBO}$	max.	—	5	$\mu\text{A}$
DC current gain $I_C = 10\text{ mA}; V_{CE} = 1\text{ V}$	$h_{FE}$	min.	60	—	
$I_C = 100\text{ mA}; V_{CE} = 1\text{ V}$	$h_{FE}$	min.	90	30	
$I_C = 500\text{ mA}; V_{CE} = 10\text{ V}$	$h_{FE}$	max.	270	—	
$I_C = 500\text{ mA}; V_{CE} = 10\text{ V}$	$h_{FE}$	min.	50	—	
Collector-emitter saturation voltage $I_C = 100\text{ mA}; I_B = 10\text{ mA}$	$V_{CEsat}$	max.	0.3	0.5	V
Base-emitter saturation voltage $I_C = 100\text{ mA}; I_B = 10\text{ mA}$	$V_{BEsat}$	max.	1.0	1.2	V
Collector-base capacitance $I_E = 0; V_{CB} = 10\text{ V}; f = 1\text{ MHz}$	$C_{ob}$	max.	5	5	pF



## SILICON PLANAR EPITAXIAL TRANSISTORS

PNP silicon planar epitaxial small-signal transistors, each in a plastic TO-92 envelope.  
They are intended for amplifier applications.  
NPN complementary types are MPS6531 and MPS6532.

### QUICK REFERENCE DATA

			MPS6534	MPS6535	
Collector-emitter voltage (open base)	$-V_{CEO}$	max.	40	30	V
Collector-base voltage (open emitter)	$-V_{CBO}$	max.	40	30	V
DC collector current	$-I_C$	max.	600		mA
Total power dissipation at $T_{amb} = 25\text{ }^\circ\text{C}$	$P_{tot}$	max.	625		mW
Collector-emitter saturation voltage $-I_C = 100\text{ mA}; -I_B = 10\text{ mA}$	$-V_{CEsat}$	max.	0.3	0.5	V
DC current gain $-I_C = 100\text{ mA}; -V_{CE} = 1\text{ V}$	$h_{FE}$	min.	90	30	
		max.	270	—	

### MECHANICAL DATA

Dimensions in mm

#### Pinning

- 1 = collector
- 2 = base
- 3 = emitter

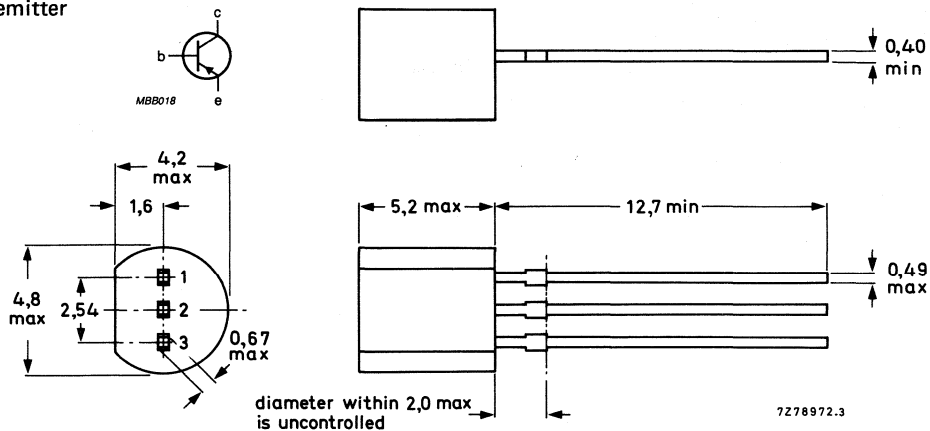

Fig. 1 TO-92.

**RATINGS**

Limiting values in accordance with the Absolute Maximum System (IEC 134)

			MPS6534	MPS6535	
Collector-emitter voltage (open base)	$-V_{CEO}$	max.	40	30	V
Collector-base voltage (open emitter)	$-V_{CBO}$	max.	40	30	V
Emitter-base voltage (open collector)	$-V_{EBO}$	max.	5.0		V
DC collector current	$-I_C$	max.	600		mA
Total power dissipation at $T_{amb} = 25\text{ }^\circ\text{C}$	$P_{tot}$	max.	625		mW
Storage temperature range	$T_{stg}$		-65 to + 150		$^\circ\text{C}$
Junction temperature	$T_j$	=	150		$^\circ\text{C}$

**CHARACTERISTICS**

$T_j = 25\text{ }^\circ\text{C}$  unless otherwise specified

			MPS6534	MPS6535	
Collector-emitter breakdown voltage $-I_B = 0; -I_C = 10\text{ mA}$	$-V_{(BR)CEO}$	min.	40	30	V
Collector-base breakdown voltage $-I_E = 0; -I_C = 10\text{ }\mu\text{A}$	$-V_{(BR)CBO}$	min.	40	30	V
Collector cut-off currents $-I_E = 0; -V_{CB} = 30\text{ V}$	$-I_{CBO}$	max.	50	50	nA
$-I_E = 0; -V_{CB} = 30\text{ V}; T_{amb} = 60\text{ }^\circ\text{C}$	$-I_{CBO}$	max.	2	—	$\mu\text{A}$
$-I_E = 0; -V_{CB} = 20\text{ V}; T_{amb} = 60\text{ }^\circ\text{C}$	$-I_{CBO}$	max.	—	5	$\mu\text{A}$
DC current gain $-I_C = 10\text{ mA}; -V_{CE} = 1\text{ V}$	$h_{FE}$	min.	60	—	
$-I_C = 100\text{ mA}; -V_{CE} = 1\text{ V}$	$h_{FE}$	min.	90	30	
$-I_C = 500\text{ mA}; -V_{CE} = 10\text{ V}$	$h_{FE}$	max.	270	—	
	$h_{FE}$	min.	50	—	
Collector-emitter saturation voltage $-I_C = 100\text{ mA}; -I_B = 10\text{ mA}$	$-V_{CEsat}$	max.	0.3	0.5	V
Base-emitter saturation voltage $-I_C = 100\text{ mA}; -I_B = 10\text{ mA}$	$-V_{BEsat}$	max.	1.0	1.2	V
Collector capacitance $-I_E = -i_e = 0; -V_{CB} = 10\text{ V}; f = 1\text{ MHz}$	$C_C$	max.	10	10	pF





## SILICON PLANAR EPITAXIAL TRANSISTORS

N-P-N silicon planar epitaxial transistors in plastic TO-92 envelope for general purpose applications.

### QUICK REFERENCE DATA

			MPSA05	MPSA06
Collector-emitter voltage (open base)	$V_{CEO}$	max.	60	80 V
Collector-base voltage (open emitter)	$V_{CBO}$	max.	60	80 V
Collector current (d.c.)	$I_C$	max.	500	mA
Total device dissipation at $T_{amb} = 25\text{ }^\circ\text{C}$	$P_{tot}$	max.	625	mW
Collector-emitter saturation voltage $I_C = 100\text{ mA}; I_B = 10\text{ mA}$	$V_{CEsat}$	max.	0,25	V
D.C. current gain $I_C = 10\text{ mA}; V_{CE} = 1,0\text{ V}$	$h_{FE}$	min.	50	

### MECHANICAL DATA

Dimensions in mm

Fig. 1 TO-92.

#### Pinning

- 1 = collector
- 2 = base
- 3 = emitter

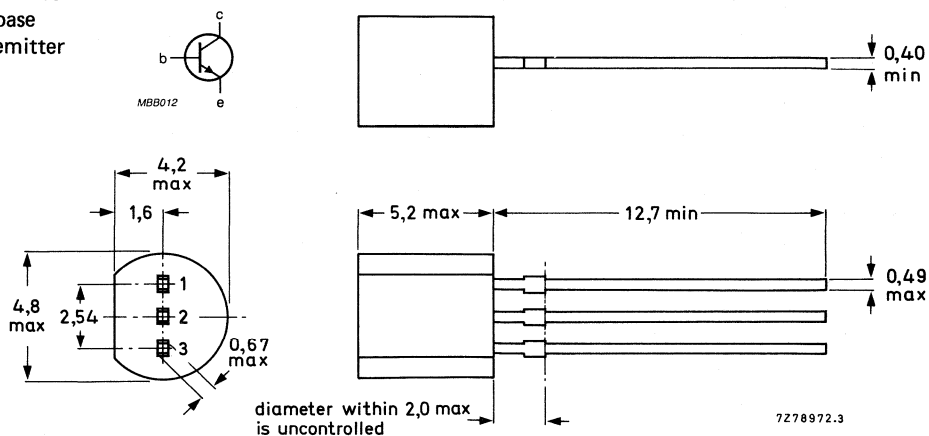

### RATINGS

Limiting values in accordance with the Absolute Maximum System (IEC 134)

		MPSA05	MPSA06
Collector-emitter voltage (open base)	$V_{CE0}$ max.	60	80 V
Collector-base voltage (open emitter)	$V_{CB0}$ max.	60	80 V
Emitter-base voltage (open collector)	$V_{EBO}$	4,0	V
Collector current (d.c.)	$I_C$ max.	500	mA
Total device dissipation at $T_{amb} = 25\text{ }^{\circ}\text{C}$	$P_{tot}$ max.	625	mW
Storage temperature	$T_{stg}$	-65 to +150	$^{\circ}\text{C}$
Junction temperature	$T_j$ max.	150	$^{\circ}\text{C}$

### THERMAL RESISTANCE

From junction to ambient	$R_{th\ j-a}$ =	200	K/W
--------------------------	-----------------	-----	-----

### CHARACTERISTICS

$T_j = 25\text{ }^{\circ}\text{C}$  unless otherwise specified

Collector-emitter breakdown voltage $I_B = 0; I_C = 1,0\text{ mA}$	$V_{(BR)CE0}$	60	80 V
Emitter-base breakdown voltage $I_E = 100\text{ }\mu\text{A}; I_C = 0$	$V_{(BR)EBO}$	4,0	V
Collector-emitter cut-off current $I_B = 0; V_{CE} = 60\text{ V}$	$I_{CEO}$ max.	0,1	$\mu\text{A}$
Collector cut-off current $I_E = 0; V_{CB} = 60\text{ V}$ $I_E = 0; V_{CB} = 80\text{ V}$	$I_{CBO}$ max. $I_{CBO}$ max.	0,1	$\mu\text{A}$ 0,1 $\mu\text{A}$
D.C. current gain $I_C = 10\text{ mA}; V_{CE} = 1,0\text{ V}$ $I_C = 100\text{ mA}; V_{CE} = 1,0\text{ V}$	$h_{FE}$ min. $h_{FE}$ min.	50 50	
Saturation voltage $I_C = 100\text{ mA}; I_B = 10\text{ mA}$	$V_{CEsat}$ max.	0,25	V
Base-emitter ON-voltage $I_C = 100\text{ mA}; V_{CE} = 1,0\text{ V}$	$V_{BE(on)}$ max.	1,2	V
Transition frequency at $f = 100\text{ MHz}^*$ $I_C = 10\text{ mA}; V_{CE} = 2,0\text{ V}$	$f_T$ min.	100	MHz

\*  $f_T$  is defined as the frequency at which  $|h_{fe}|$  extrapolates to unity.



## SILICON PLANAR EPITAXIAL DARLINGTON TRANSISTORS

N-P-N silicon planar epitaxial darlington transistors in plastic TO-92 envelope for general purpose applications.

### QUICK REFERENCE DATA

		MPSA13	MPSA14
Collector-emitter voltage $V_{BE} = 0$	$V_{CES}$ max.	30	V
Collector-base voltage (open emitter)	$V_{CBO}$ max.	30	V
Collector current (d.c.)	$I_C$ max.	500	mA
Total device dissipation at $T_{amb} = 25\text{ }^\circ\text{C}$	$P_{tot}$ max.	625	mW
Collector-emitter saturation voltage $I_C = 100\text{ mA}; I_B = 0,1\text{ mA}$	$V_{CEsat}$ max.	1,5	V
D.C. current gain $I_C = 10\text{ mA}; V_{CE} = 5,0\text{ V}$	$h_{FE}$ min.	5000	10 000

### MECHANICAL DATA

Dimensions in mm

Fig. 1 TO-92.

#### Pinning

- 1 = collector
- 2 = base
- 3 = emitter

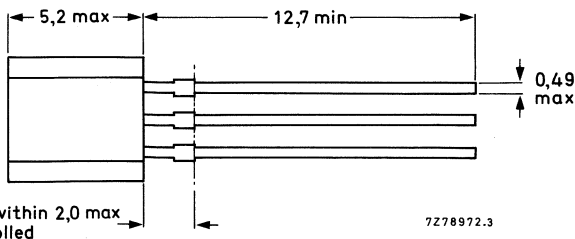
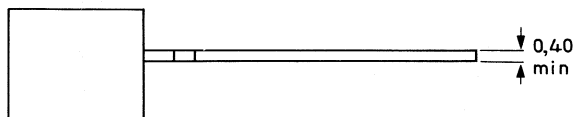
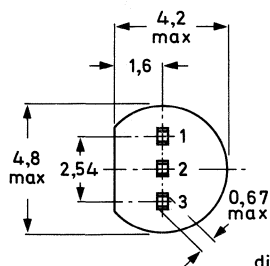
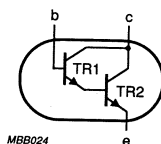

## RATINGS

Limiting values in accordance with the Absolute Maximum System (IEC 134)

		MPSA13	MPSA14
Collector-emitter voltage $V_{BE} = 0$	$V_{CES}$ max.	30	V
Collector-base voltage (open emitter)	$V_{CBO}$ max.	30	V
Emitter-base voltage (open collector)	$V_{EBO}$ max.	10	V
Collector current (d.c.)	$I_C$ max.	500	mA
Total device dissipation at $T_{amb} = 25\text{ }^\circ\text{C}$	$P_{tot}$ max.	625	mW
Storage temperature range	$T_{stg}$	-65 to +150	$^\circ\text{C}$
Junction temperature	$T_j$ max.	150	$^\circ\text{C}$

## THERMAL RESISTANCE

From junction to ambient	$R_{th\ j-a}$ =	200	K/W
--------------------------	-----------------	-----	-----

## CHARACTERISTICS

$T_j = 25\text{ }^\circ\text{C}$  unless otherwise specified

Collector-emitter breakdown voltage $I_B = 0; I_C = 100\text{ }\mu\text{A}$	$V(BR)_{CES}$ min.	30	V
Collector cut-off current $I_E = 0; V_{CB} = 30\text{ V}$	$I_{CBO}$ max.	0,1	$\mu\text{A}$
Emitter cut-off current $I_C = 0; V_{BE} = 10\text{ V}$	$I_{EBO}$ max.	0,1	$\mu\text{A}$
D.C current gain $I_C = 10\text{ mA}; V_{CE} = 5,0\text{ V}$ $I_C = 100\text{ mA}; V_{CE} = 5,0\text{ V}$	$h_{FE}$ min.	5000	10 000
	$h_{FE}$ min.	10 000	20 000
Saturation voltage $I_C = 100\text{ mA}; I_B = 0,1\text{ mA}$	$V_{CEsat}$ max.	1,5	V
Base-emitter ON-voltage $I_C = 100\text{ mA}; V_{CE} = 5,0\text{ V}$	$V_{BE(on)}$ max.	2,0	V
Transition frequency at $f = 100\text{ MHz}^*$ $I_C = 10\text{ mA}; V_{CE} = 5,0\text{ V}; T_{amb} = 25\text{ }^\circ\text{C}$	$f_T$ min.	125	MHz

\*  $f_T$  is defined as the frequency at which  $|h_{fe}|$  extrapolates to unity.



## NPN DARLINGTON TRANSISTOR

NPN small-signal Darlington transistors, each in a plastic TO-92 envelope.  
PNP complementary types are MPSA75, MPSA76, and MPSA77.

### QUICK REFERENCE DATA

		MPSA25			26	27
Collector-emitter voltage	$V_{CE0}$	max.	40	50	60	V
Emitter-base voltage	$V_{EBO}$	max.		10		V
DC collector current	$I_C$	max.		500		mA
Total power dissipation up to $T_{amb} = 25\text{ }^\circ\text{C}$	$P_{tot}$	max.		500		mW
DC current gain $I_C = 10\text{ mA}, V_{CE} = 5\text{ V}$	$h_{FE}$	min.		10000		

### MECHANICAL DATA

Dimensions in mm

Fig.1 TO-92.

#### Pinning

- 1 = collector
- 2 = base
- 3 = emitter

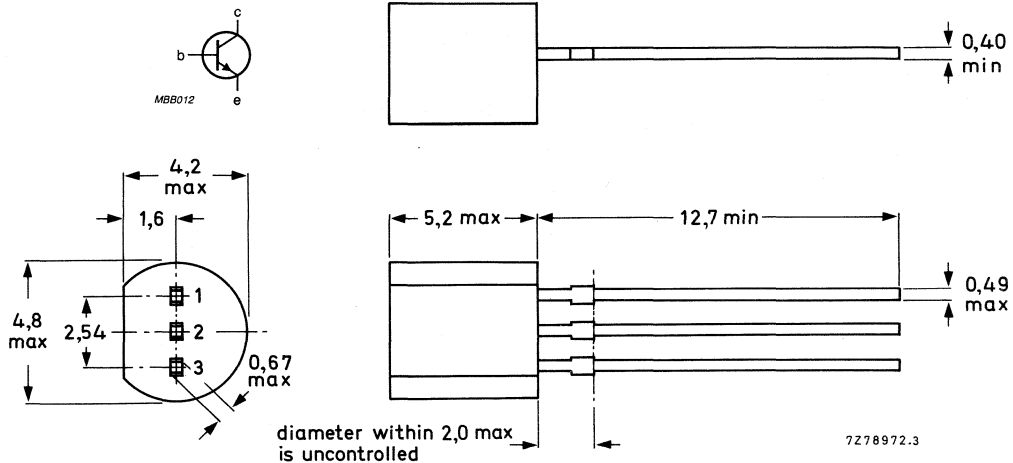

Capability approved to CECC NECC-C-002

### RATINGS

Limiting values in accordance with the Absolute Maximum System (IEC 134)

			MPSA25	26	27
Collector-emitter voltage	$V_{CEO}$	max.	40	50	60 V
Emitter-base voltage	$V_{EBO}$	max.		10	V
DC collector current	$I_C$	max.		500	mA
Total power dissipation up to $T_{amb} = 25\text{ }^\circ\text{C}$	$P_{tot}$	max.		500	mW
Storage temperature range	$T_{stg}$		-65 to +150		$^\circ\text{C}$
Junction temperature	$T_j$	max.		150	$^\circ\text{C}$

### THERMAL RESISTANCE

From junction to ambient in free air	$R_{th\ j-a}$	=		250	K/W
--------------------------------------	---------------	---	--	-----	-----

### CHARACTERISTICS

$T_j = 25\text{ }^\circ\text{C}$  unless otherwise specified

			MPSA25	26	27
Collector-emitter breakdown voltage $I_C = 100\text{ }\mu\text{A}; V_{BE} = 0$	$V_{(BR)CES}$	min.	50	50	60 V
Collector-base breakdown voltage $I_C = 100\text{ }\mu\text{A}; I_E = 0$	$V_{(BR)CBO}$	min.	40	50	60 V
Collector cut-off current $V_{CB} = 40\text{ V}; I_E = 0$	$I_{CBO}$	max.	100	100	- nA
$V_{CB} = 50\text{ V}; I_E = 0$	$I_{CBO}$	max.	-	-	100 nA
Emitter cut-off current $V_{EB} = 10\text{ V}; I_C = 0$	$I_{EBO}$	max.		100	nA
DC current gain $I_C = 10\text{ mA}; V_{CE} = 5\text{ V}$	$h_{FE}$	min.		10000	
$I_C = 100\text{ mA}; V_{CE} = 5\text{ V}$	$h_{FE}$	min.		10000	
Collector-emitter saturation voltage $I_C = 100\text{ mA}; I_B = 0.1\text{ mA}$	$V_{CEsat}$	max.		1.5	V
Base-emitter on-voltage $I_C = 100\text{ mA}; V_{CE} = 5\text{ V}$	$V_{BE\ on}$	max.		2.0	V
Transition frequency at $T_{amb} = 25\text{ }^\circ\text{C}$ $I_C = 30\text{ mA}; V_{CE} = 5\text{ V}; f = 100\text{ MHz}$	$f_T$	min. typ.		125 220	MHz MHz



## HIGH VOLTAGE SILICON PLANAR TRANSISTORS

N-P-N high voltage silicon planar transistors in plastic TO-92 envelope for use in general purpose applications.

### QUICK REFERENCE DATA

			MPSA42	MPSA43
Collector-emitter voltage (open base)	$V_{CEO}$	max.	300	200 V
Collector-base voltage (open emitter)	$V_{CBO}$	max.	300	200 V
Collector current (d.c.)	$I_C$	max.	500	mA
Total device dissipation at $T_{amb} = 25\text{ }^\circ\text{C}$	$P_{tot}$	max.	625	mW
Collector-emitter saturation voltage $I_C = 20\text{ mA}; I_B = 2,0\text{ mA}$	$V_{CEsat}$	max.	0,5	V
D.C. current gain $I_C = 30\text{ mA}; V_{CE} = 10\text{ V}$	$h_{FE}$	min.	40	

### MECHANICAL DATA

Dimensions in mm

Fig. 1 TO-92.

#### Pinning

- 1 = collector
- 2 = base
- 3 = emitter

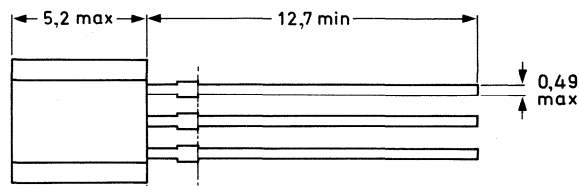
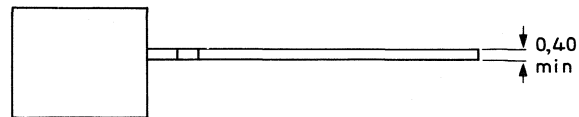
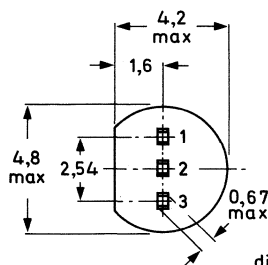
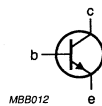

diameter within 2,0 max  
is uncontrolled

7278972.3

**RATINGS**

Limiting values in accordance with the Absolute Maximum System (IEC 134)

		MPSA42	MPSA43
Collector-emitter voltage (open base)	$V_{CEO}$ max.	300	200 V
Collector-base voltage (open emitter)	$V_{CBO}$ max.	300	200 V
Emitter-base voltage (open collector)	$V_{EBO}$ max.	6,0	V
Collector current (d.c.)	$I_C$ max.	500	mA
Total device dissipation at $T_{amb} = 25\text{ }^{\circ}\text{C}$	$P_{tot}$ max.	625	mW
Storage temperature range	$T_{stg}$	-65 to +150	$^{\circ}\text{C}$
Junction temperature	$T_j$ max.	150	$^{\circ}\text{C}$

**THERMAL RESISTANCE**

From junction to ambient	$R_{th\ j-a}$ =	200	K/W
--------------------------	-----------------	-----	-----

**CHARACTERISTICS**

$T_j = 25\text{ }^{\circ}\text{C}$  unless otherwise specified

Collector-emitter breakdown voltage* $I_B = 0; I_C = 1,0\text{ mA}$	$V_{(BR)CES}$		300	200 V
Collector-base breakdown voltage $I_E = 0; I_C = 100\text{ }\mu\text{A}$	$V_{(BR)CBO}$		300	200 V
Emitter-base breakdown voltage $I_C = 0; I_E = 100\text{ }\mu\text{A}$	$V_{(BR)EBO}$		6,0	V
Collector cut-off current $I_E = 0; V_{CB} = 200\text{ V}$ $I_E = 0; V_{CB} = 160\text{ V}$	$I_{CBO}$ max. $I_{CBO}$ max.		0,1	$\mu\text{A}$ 0,1 $\mu\text{A}$
Emitter cut-off current $I_C = 0; V_{BE} = 6,0\text{ V}$ $I_C = 0; V_{BE} = 4,0\text{ V}$	$I_{EBO}$ max. $I_{EBO}$ max.		0,1	$\mu\text{A}$ 0,1 $\mu\text{A}$
D.C. current gain*	$h_{FE}$ min. $h_{FE}$ min. $h_{FE}$ min.		25 40 40	
Saturation voltages*	$V_{CEsat}$ max. $V_{BEsat}$ max.		0,5 0,9	V V
Transition frequency at $f = 100\text{ MHz}$ $I_C = 10\text{ mA}; V_{CE} = 20\text{ V}$	$f_T$ min.		50	MHz
Collector-base capacitance at $f = 1\text{ kHz}$ $V_{CB} = 20\text{ V}; I_E = 0$	$C_{cb}$ max.		3,0	4,0 pF

\* Pulse test: pulse width  $\leq 300\text{ }\mu\text{s}$ , duty cycle  $\leq 2\%$ .





## SILICON PLANAR EPITAXIAL TRANSISTORS

P-N-P silicon planar epitaxial transistors in plastic TO-92 envelope for general purpose applications.

### QUICK REFERENCE DATA

			MPSA55	MPSA56
Collector-emitter voltage (open base)	$-V_{CEO}$	max.	60	80 V
Collector-base voltage (open emitter)	$-V_{CBO}$	max.	60	80 V
Collector current (d.c.)	$-I_C$	max.	500	mA
Total device dissipation at $T_{amb} = 25^\circ\text{C}$	$P_{tot}$	max.	625	mW
Collector-emitter saturation voltage $-I_C = 100\text{ mA}; -I_B = 10\text{ mA}$	$-V_{CEsat}$	max.	0,25	V
D.C. current gain $-I_C = 100\text{ mA}; -V_{CE} = 1,0\text{ V}$	$h_{FE}$	min.	50	

### MECHANICAL DATA

Dimensions in mm

Fig. 1 TO-92.

#### Pinning

- 1 = collector
- 2 = base
- 3 = emitter

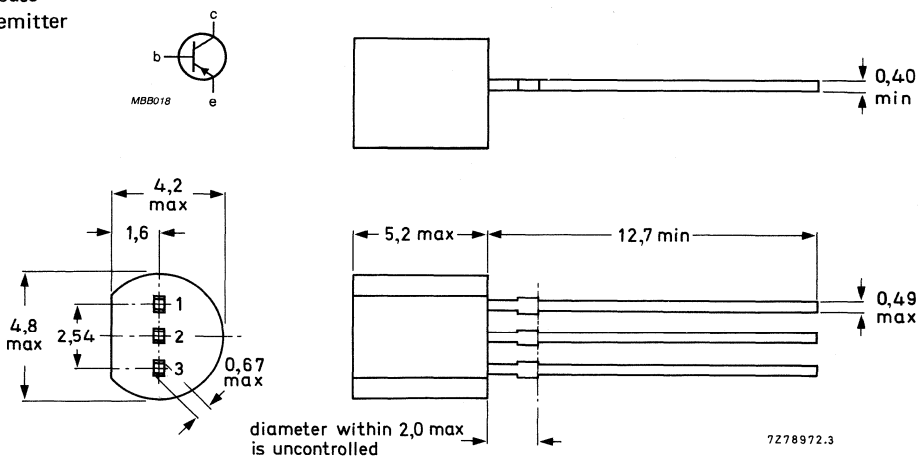

**RATINGS**

Limiting values in accordance with the Absolute Maximum System (IEC 134)

			MPSA55	MPSA56
Collector-emitter voltage (open base)	$-V_{CEO}$	max.	60	80 V
Collector-base voltage (open emitter)	$-V_{CBO}$	max.	60	80 V
Emitter-base voltage (open collector)	$-V_{EBO}$	max.	4,0	V
Collector current (d.c.)	$-I_C$	max.	500	mA
Total device dissipation at $T_{amb} = 25\text{ }^\circ\text{C}$	$P_{tot}$	max.	625	mW
Storage temperature range	$T_{stg}$		-65 to +150	$^\circ\text{C}$
Junction temperature	$T_j$	max.	150	$^\circ\text{C}$

**THERMAL RESISTANCE**

From junction to ambient	$R_{th\ j-a}$	=	200	K/W
--------------------------	---------------	---	-----	-----

**CHARACTERISTICS**

$T_j = 25\text{ }^\circ\text{C}$  unless otherwise specified

Collector-emitter breakdown voltage $I_B = 0; I_C = 1,0\text{ mA}$	$-V_{(BR)CEO}$	min.	60	80 V
Emitter-base breakdown voltage $-I_E = 100\text{ }\mu\text{A}; -I_C = 0$	$-V_{(BR)EBO}$	min.	4,0	V
Collector cut-off current $I_E = 0; -V_{CB} = 60\text{ V}$	$-I_{CBO}$	max.	0,1	$\mu\text{A}$
$I_E = 0; -V_{CB} = 80\text{ V}$	$-I_{CBO}$	max.		0,1 $\mu\text{A}$
Collector-emitter cut-off current $I_B = 0; -V_{CE} = 60\text{ V}$	$-I_{CEO}$	max.	0,1	$\mu\text{A}$
D.C. current gain $-I_C = 10\text{ mA}; -V_{CE} = 1,0\text{ V}$	$h_{FE}$	min.	50	
$-I_C = 100\text{ mA}; -V_{CE} = 1,0\text{ V}$	$h_{FE}$	min.	50	
Saturation voltage $-I_C = 100\text{ mA}; -I_B = 10\text{ mA}$	$-V_{CEsat}$	max.	0,25	V
Base-emitter on-voltage $-I_C = 100\text{ mA}; -V_{CE} = 1,0\text{ V}$	$-V_{BE(on)}$	max.	1,2	V
Transition frequency at $f = 100\text{ MHz}^*$ $-I_C = 100\text{ mA}; -V_{CE} = 1,0\text{ V}$	$f_T$	min.	50	MHz

\*  $f_T$  is defined as the frequency at which  $|h_{fe}|$  extrapolates to unity.



## P-N-P DARLINGTON TRANSISTORS

P-N-P darlington transistors in a plastic TO-92 envelope for general purpose applications.

### QUICK REFERENCE DATA

			MPSA63	MPSA64
Collector-emitter voltage $V_{BE} = 0$	$-V_{CES}$	max.	30	V
Collector-base voltage (open emitter)	$-V_{CBO}$	max.	30	V
Collector current (d.c.)	$-I_C$	max.	500	mA
Total device dissipation at $T_{amb} = 25\text{ }^\circ\text{C}$	$P_{tot}$	max.	625	mW
Collector-emitter saturation voltage $-I_C = 100\text{ mA}; -I_B = 0,1\text{ mA}$	$-V_{CEsat}$	max.	1,5	V
D.C. current gain $-I_C = 10\text{ mA}; -V_{CE} = 5,0\text{ V}$	$h_{FE}$	min.	5000	10 000

### MECHANICAL DATA

Dimensions in mm

Fig. 1 TO-92.

#### Pinning

- 1 = collector
- 2 = base
- 3 = emitter

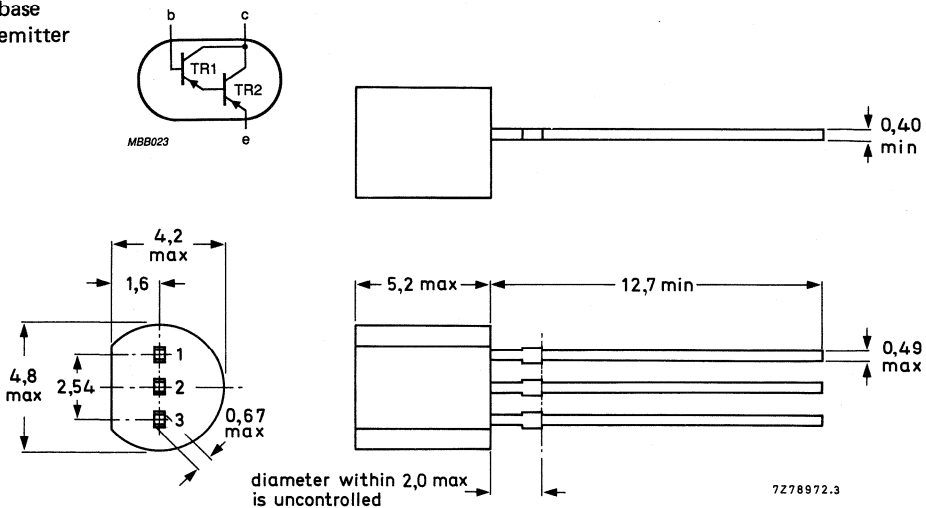

**RATINGS**

Limiting values in accordance with the Absolute Maximum System (IEC 134)

			MPSA63	MPSA64
Collector-emitter voltage $V_{BE} = 0$	$-V_{CES}$	max.	30	V
Collector-base voltage (open emitter)	$-V_{CBO}$	max.	30	V
Emitter-base voltage (open collector)	$-V_{EBO}$	max.	10	V
Collector current (d.c.)	$-I_C$	max.	500	mA
Total device dissipation at $T_{amb} = 25\text{ }^{\circ}\text{C}$	$P_{tot}$	max.	625	mW
Storage temperature range	$T_{stg}$		-65 to +150	$^{\circ}\text{C}$
Junction temperature	$T_j$	max.	150	$^{\circ}\text{C}$

**THERMAL RESISTANCE**

From junction to ambient	$R_{th\ j-a}$	=	200	K/W
--------------------------	---------------	---	-----	-----

**CHARACTERISTICS**

$T_j = 25\text{ }^{\circ}\text{C}$  unless otherwise specified

Collector-emitter breakdown voltage $-I_C = 100\text{ }\mu\text{A}; -V_{BE} = 0$	$-V_{(BR)CES}$	min.	30	V
Collector cut-off current $I_E = 0; -V_{CB} = 30\text{ V}$	$-I_{CBO}$	max.	100	nA
Emitter cut-off current $I_C = 0; -V_{BE} = 10\text{ V}$	$-I_{EBO}$	max.	100	nA
D.C. current gain $-I_C = 10\text{ mA}; -V_{CE} = 5,0\text{ V}$	$h_{FE}$	min.	5000	10 000
$-I_C = 100\text{ mA}; -V_{CE} = 5,0\text{ V}$	$h_{FE}$	min.	10 000	20 000
Saturation voltage $-I_C = 100\text{ mA}; -I_B = 0,1\text{ mA}$	$-V_{CEsat}$	max.	1,5	V
Base-emitter ON-voltage* $-I_C = 100\text{ mA}; -V_{CE} = 5,0\text{ V}$	$-V_{BE(on)}$		2,0	V
Transition frequency at $f = 100\text{ MHz}^*$ $-I_C = 100\text{ mA}; -V_{CE} = 5,0\text{ V}$	$f_T$	min.	125	MHz

\*  $f_T$  is defined as the frequency at which  $|h_{fe}|$  extrapolates to unity.



## PNP DARLINGTON TRANSISTOR

PNP small-signal Darlington transistors, each in a plastic TO-92 envelope.  
NPN complementary types are MPSA25, 26, and 27.

### QUICK REFERENCE DATA

			MPSA75	76	77
Collector-emitter voltage	$-V_{CEO}$	max.	40	50	60 V
Emitter-base voltage	$-V_{EBO}$	max.		10	V
Collector current (DC)	$-I_C$	max.		500	mA
Total power dissipation up to $T_{amb} = 25^\circ\text{C}$	$P_{tot}$	max.		500	mW
DC current gain $-I_C = 10\text{ mA}; -V_{CE} = 5\text{ V}$	$h_{FE}$	min.		10 000	

### MECHANICAL DATA

Dimensions in mm

Fig.1 TO-92.

#### Pinning

- 1 = collector
- 2 = base
- 3 = emitter

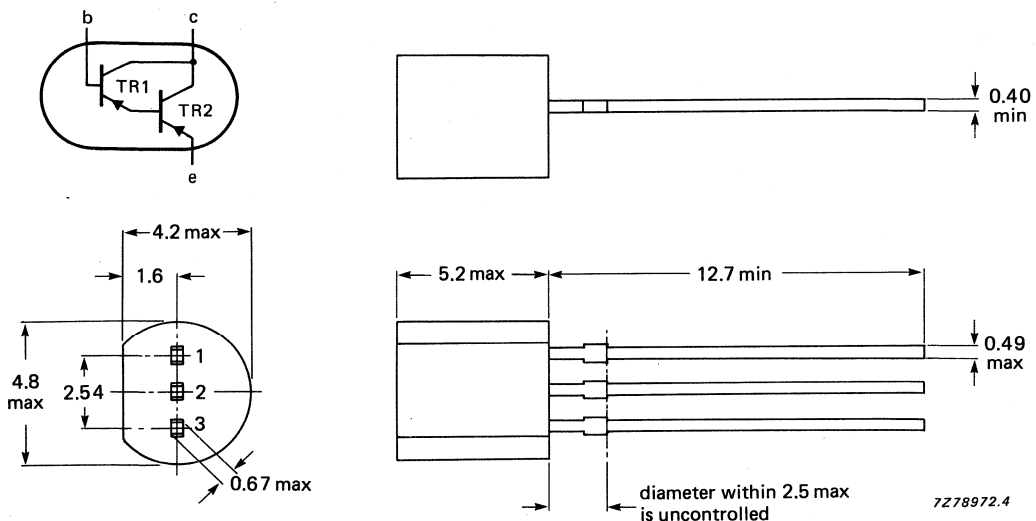

### RATINGS

Limiting values in accordance with the Absolute Maximum System (IEC 134)

			MPSA75	76	77	
Collector-emitter voltage	$-V_{CEO}$	max.	40	50	60	V
Emitter-base voltage	$-V_{EBO}$	max.		10		V
Collector current (DC)	$-I_C$	max.		500		mA
Total power dissipation up to $T_{amb} = 25\text{ }^\circ\text{C}$	$P_{tot}$	max.		500		mW
Storage temperature range	$T_{stg}$			-65 to +150		$^\circ\text{C}$
Junction temperature	$T_j$	max.		150		$^\circ\text{C}$

### THERMAL RESISTANCE

From junction to ambient in free air	$R_{thj-a}$	=		250		K/W
--------------------------------------	-------------	---	--	-----	--	-----

### CHARACTERISTICS

$T_j = 25\text{ }^\circ\text{C}$  unless otherwise specified

			MPSA75	76	77	
Collector-emitter breakdown voltage $-I_C = 100\text{ }\mu\text{A}; -V_{BE} = 0$	$-V_{(BR)CES}$	min.	40	50	60	V
Collector-base breakdown voltage $-I_C = 100\text{ }\mu\text{A}; -I_E = 0$	$-V_{(BR)CBO}$	min.	40	50	60	V
Collector cut-off current $-V_{CB} = 40\text{ V}; -I_E = 0$	$-I_{CBO}$	max.	100	100	-	nA
$-V_{CB} = 50\text{ V}; -I_E = 0$	$-I_{CBO}$	max.	-	-	100	nA
Emitter cut-off current $-V_{EB} = 40\text{ V}; -I_C = 0$	$-I_{EBO}$	max.		100		nA
DC current gain $-I_C = 10\text{ mA}; -V_{CE} = 5\text{ V}$	$h_{FE}$	min.		10 000		
$-I_C = 100\text{ mA}; -V_{CE} = 5\text{ V}$	$h_{FE}$	min.		10 000		
Collector-emitter saturation voltage $-I_C = 100\text{ mA}; -I_B = 0.1\text{ mA}$	$-V_{CEsat}$	max.		1.5		V
Base-emitter on-voltage $-I_C = 10\text{ mA}; -V_{CE} = 5\text{ V}$	$-V_{BEon}$	max.		2.0		V
Transition frequency at $T_{amb} = 25\text{ }^\circ\text{C}$ $-I_C = 30\text{ mA}; -V_{CE} = 5\text{ V}; f = 100\text{ MHz}$	$f_T$	min. typ.		125 220		MHz MHz



## HIGH VOLTAGE SILICON PLANAR TRANSISTORS

P-N-P high voltage silicon planar transistors in plastic TO-92 envelope for general purpose applications.

### QUICK REFERENCE DATA

			MPSA92	MPSA93
Collector-emitter voltage (open base)	$-V_{CEO}$	max.	300	200 V
Collector-base voltage (open emitter)	$-V_{CBO}$	max.	300	200 V
Collector current (d.c.)	$-I_C$	max.	500	mA
Total device dissipation at $T_{amb} = 25\text{ }^\circ\text{C}$	$P_{tot}$	max.	625	mW
Collector-emitter saturation voltage $-I_C = 20\text{ mA}; -I_B = 2,0\text{ mA}$	$-V_{CEsat}$	max.	0,5	V
D.C. current gain $-I_C = 30\text{ mA}; -V_{CE} = 10\text{ V}$	$h_{FE}$	min.	25	

### MECHANICAL DATA

Dimensions in mm

Fig. 1 TO-92.

#### Pinning

- 1 = collector
- 2 = base
- 3 = emitter

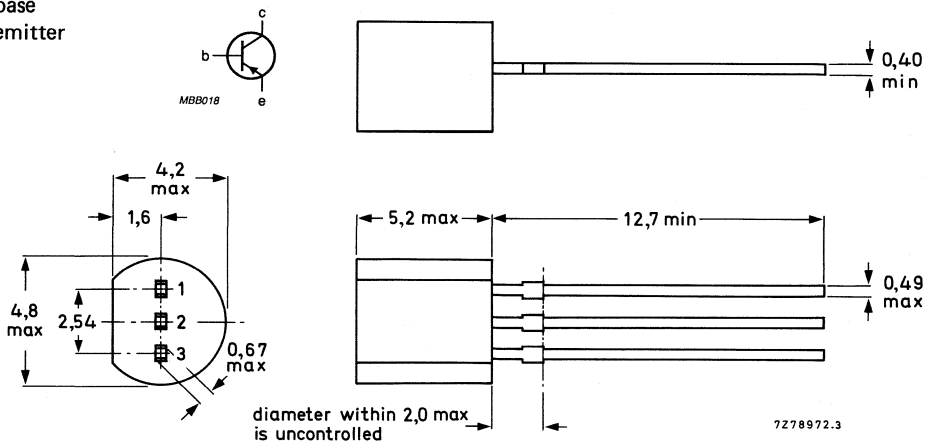

## RATINGS

Limiting values in accordance with the Absolute Maximum System (IEC 134)

			MPSA92	MPSA93
Collector-emitter voltage (open base)	$V_{CEO}$	max.	300	200 V
Collector-base voltage (open emitter)	$V_{CBO}$	max.	300	200 V
Emitter-base voltage (open collector)	$V_{EBO}$	max.	5,0	V
Collector current (d.c.)	$I_C$	max.	500	mA
Total device dissipation at $T_{amb} = 25\text{ }^{\circ}\text{C}$	$P_{tot}$	max.	625	mW
Storage temperature range	$T_{stg}$		-65 to +150	$^{\circ}\text{C}$
Junction temperature	$T_j$	max.	150	$^{\circ}\text{C}$

## THERMAL RESISTANCE

From junction to ambient	$R_{th\ j-a}$	=	200	K/W
--------------------------	---------------	---	-----	-----

## CHARACTERISTICS

$T_j = 25\text{ }^{\circ}\text{C}$  unless otherwise specified

Collector-emitter breakdown voltage $I_B = 0; -I_C = 1,0\text{ mA}$	$-V_{(BR)CEO}$	min.	300	200 V
Collector-base breakdown voltage $I_E = 0; -I_C = 100\text{ }\mu\text{A}$	$-V_{(BR)CBO}$	min.	300	200 V
Emitter-base breakdown voltage $I_C = 0; -I_E = 100\text{ }\mu\text{A}$	$-V_{(BR)EBO}$	min.	5,0	V
Collector cut-off current $I_E = 0; -V_{CB} = 200\text{ V}$	$-I_{CBO}$	max.	0,25	$\mu\text{A}$
$I_E = 0; -V_{CB} = 160\text{ V}$	$-I_{CBO}$	max.		0,25 $\mu\text{A}$
Emitter cut-off current $I_C = 0; -V_{BE} = 3,0\text{ V}$	$-I_{EBO}$	max.	0,1	$\mu\text{A}$
D.C. current gain*				
$-I_C = 1,0\text{ mA}; -V_{CE} = 10\text{ V}$	$h_{FE}$	min.	25	
$-I_C = 10\text{ mA}; -V_{CE} = 10\text{ V}$	$h_{FE}$	min.	40	
$-I_C = 30\text{ mA}; -V_{CE} = 10\text{ V}$	$h_{FE}$	min.	25	
Saturation voltages*				
$-I_C = 20\text{ mA}; -I_B = 2,0\text{ mA}$	$-V_{CEsat}$	max.	0,5	V
$-I_C = 20\text{ mA}; -I_B = 2,0\text{ mA}$	$-V_{BEsat}$	max.	0,9	V
Transition frequency at $f = 100\text{ MHz}$ $-I_C = 10\text{ mA}; -V_{CE} = 20\text{ V}$	$f_T$	min.	50	MHz
Collector-base capacitance at $f = 1\text{ MHz}$ $-V_{CB} = 20\text{ V}; I_E = 0$	$C_{cb}$	max.	6,0	8,0 pF

\* Pulse test: pulse width  $\leq 300\text{ }\mu\text{s}$ , duty cycle  $\leq 2\%$ .





## SILICON PLANAR EPITAXIAL TRANSISTORS

NPN transistors in plastic TO-92 envelopes, primarily intended for switching and linear applications.

### QUICK REFERENCE DATA

			PH2222	PH2222A	
Collector-base voltage (open emitter)	$V_{CBO}$	max.	60	75	V
Collector-emitter voltage (open base)	$V_{CEO}$	max.	30	40	V
Collector current (DC)	$I_C$	max.	800	800	mA
Total power dissipation up to $T_{amb} = 25\text{ }^\circ\text{C}$	$P_{tot}$	max.	625	625	mW
Junction temperature	$T_j$	max.	150	150	$^\circ\text{C}$
DC current gain at $T_j = 25\text{ }^\circ\text{C}$ $I_C = 10\text{ mA}; V_{CE} = 10\text{ V}$	$h_{FE}$	min.	75	75	
Transition frequency at $f = 100\text{ MHz}$ $I_C = 20\text{ mA}; V_{CE} = 20\text{ V}$	$f_T$	min.	250	300	MHz
Storage time $I_{Con} = 150\text{ mA}; I_{Bon} = -I_{Boff} = 15\text{ mA}$	$t_s$	max.	—	225	ns

### MECHANICAL DATA

Dimensions in mm

Fig. 1 TO-92.

#### Pinning

- 1 = emitter
- 2 = base
- 3 = collector

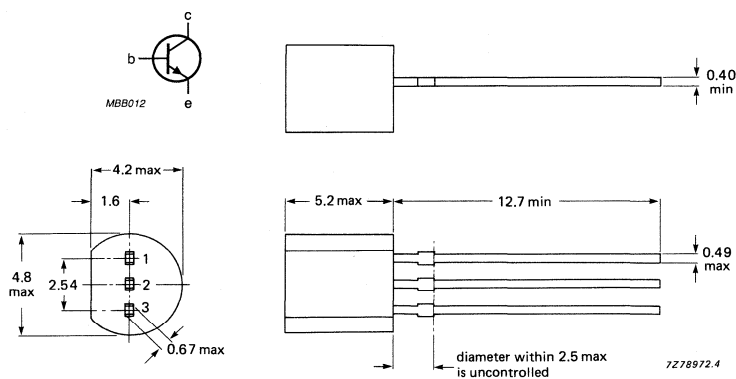

**RATINGS**

Limiting values in accordance with the Absolute Maximum System (IEC 134)

			PH2222	PH2222A	
Collector-base voltage (open emitter)	$V_{CBO}$	max.	60	75	V
Collector-emitter voltage (open base)	$V_{CEO}$	max.	30	40	V
Emitter-base voltage (open collector)	$V_{EBO}$	max.	5	6	V
Collector current (DC)	$I_C$	max.	800		mA
Total power dissipation up to $T_{amb} = 25\text{ }^\circ\text{C}$	$P_{tot}$	max.	625		mW
Storage temperature range	$T_{stg}$	max.	-65 to +150		$^\circ\text{C}$
Junction temperature	$T_j$	max.	150		$^\circ\text{C}$

**THERMAL RESISTANCE**

From junction to ambient in free air	$R_{thj-a}$	=	200	K/W
--------------------------------------	-------------	---	-----	-----

**CHARACTERISTICS**

$T_j = 25\text{ }^\circ\text{C}$  unless otherwise specified

			PH2222	PH2222A	
Collector cut-off current					
$I_E = 0; V_{CB} = 50\text{ V}$	$I_{CBO}$	max.	10	—	nA
$I_E = 0; V_{CB} = 50\text{ V}; T_{amb} = 150\text{ }^\circ\text{C}$	$I_{CBO}$	max.	10	—	$\mu\text{A}$
$I_E = 0; V_{CB} = 60\text{ V}$	$I_{CBO}$	max.	—	10	nA
$I_E = 0; V_{CB} = 60\text{ V}; T_{amb} = 150\text{ }^\circ\text{C}$	$I_{CBO}$	max.	—	10	$\mu\text{A}$
Emitter cut-off current					
$I_C = 0; V_{EB} = 3\text{ V}$	$I_{EBO}$	max.	10	10	nA
Currents are reverse biased emitter junction					
$V_{CE} = 60\text{ V}; -V_{BE} = 3\text{ V}$	$I_{CEX}$	max.	—	10	nA
	$-I_{BEX}$	max.	—	20	nA
Breakdown voltages					
$I_E = 0; I_C = 10\text{ }\mu\text{A}$	$V_{(BR)CBO}$	min.	60	75	V
$I_B = 0; I_C = 10\text{ mA}$	$V_{(BR)CEO}$	min.	30	40	V
$I_C = 0; I_E = 10\text{ }\mu\text{A}$	$V_{(BR)EBO}$	min.	5	6	V
Saturation voltages (see Note 1)					
$I_C = 150\text{ mA}; I_B = 15\text{ mA}$	$V_{CEsat}$	max.	0.4	0.3	V
	$V_{BEsat}$	min.	—	0.6	V
	$V_{BEsat}$	max.	1.3	1.2	V
$I_C = 500\text{ mA}; I_B = 50\text{ mA}$	$V_{CEsat}$	max.	1.6	1.0	V
	$V_{BEsat}$	max.	2.6	2.0	V

**Note**

1. Measured under pulse conditions:  $t_p \leq 300\text{ }\mu\text{s}$ ,  $\delta \leq 0.02$ .

		PH2222	PH2222A	
<b>DC current gain</b>				
$I_C = 0.1 \text{ mA}; V_{CE} = 10 \text{ V}$	$h_{FE}$	min. 35	35	
$I_C = 1 \text{ mA}; V_{CE} = 10 \text{ V}$	$h_{FE}$	min. 50	50	
$I_C = 10 \text{ mA}; V_{CE} = 10 \text{ V}$	$h_{FE}$	min. 75	75	
$I_C = 10 \text{ mA}; V_{CE} = 10 \text{ V}; T_{amb} = -55 \text{ }^\circ\text{C}$	$h_{FE}$	min. —	35	
$I_C = 150 \text{ mA}; V_{CE} = 1 \text{ V}$ (see note 1)	$h_{FE}$	min. 50	50	
$I_C = 150 \text{ mA}; V_{CE} = 10 \text{ V}$ (see note 1)	$h_{FE}$	min. 100	100	
$I_C = 500 \text{ mA}; V_{CE} = 10 \text{ V}$ (see note 1)	$h_{FE}$	max. 300	300	
	$h_{FE}$	min. 30	40	
<b>Transition frequency at <math>f = 100 \text{ MHz}</math></b>				
$I_C = 20 \text{ mA}; V_{CE} = 20 \text{ V}$	$f_T$	min. 250	300	MHz
<b>Collector capacitance at <math>f = 100 \text{ kHz}</math></b>				
$I_E = I_e = 0; V_{CB} = 10 \text{ V}$	$C_c$	max. 8	8	pF
<b>Emitter capacitance at <math>f = 100 \text{ kHz}</math></b>				
$I_C = I_c = 0; V_{EB} = 0.5 \text{ V}$	$C_e$	max. —	25	pF
<b>h-parameters (common emitter)</b>				
$I_C = 1 \text{ mA}; V_{CE} = 10 \text{ V}; f = 1 \text{ kHz}$				
Input impedance	$h_{ie}$	min. —	2	$k\Omega$
		max. —	8	$k\Omega$
Reverse voltage transfer ratio	$h_{re}$	max. —	8	$10^{-4}$
Small-signal current gain	$h_{fe}$	min. —	50	
		max. —	300	
Output admittance	$h_{oe}$	min. —	5	$\mu\text{S}$
		max. —	35	$\mu\text{S}$
$I_C = 10 \text{ mA}; V_{CE} = 10 \text{ V}; f = 1 \text{ kHz}$				
Input impedance	$h_{ie}$	min. —	0.25	$k\Omega$
		max. —	1.25	$k\Omega$
Reverse voltage transfer ratio	$h_{re}$	max. —	4	$10^{-4}$
Small-signal current gain	$h_{fe}$	min. —	75	
		max. —	375	
Output admittance	$h_{oe}$	min. —	25	$\mu\text{S}$
		max. —	200	$\mu\text{S}$
$I_C = 20 \text{ mA}; V_{CE} = 20 \text{ V}; f = 100 \text{ MHz}$				
Small-signal current gain	$h_{fe}$	min. 2.5	3.0	
<b>Noise figure at <math>f = 1 \text{ kHz}</math></b>				
$I_C = 0.1 \text{ mA}; V_{CE} = 10 \text{ V}$				
$R_G = 1 \text{ k}\Omega; B = 1 \text{ Hz}$	F	max. —	4	dB

**Note**1. Measured under pulse conditions:  $t_p \leq 300 \mu\text{s}; \delta \leq 0.02$ .

**Switching times (between 10% and 90% levels) for PH2222A**

Turn-on time when switched to  $I_{Con} = 150 \text{ mA}$  (see Fig. 2)

delay time  
rise time

$t_d$  max. 10 ns  
 $t_r$  max. 25 ns

Turn-off time when switched from  $I_{Con} = 150 \text{ mA}$  (see Fig. 3)

storage time  
fall time

$t_s$  max. 225 ns  
 $t_f$  max. 60 ns

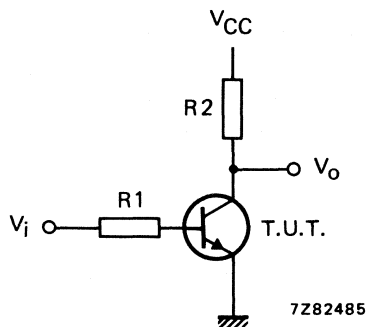
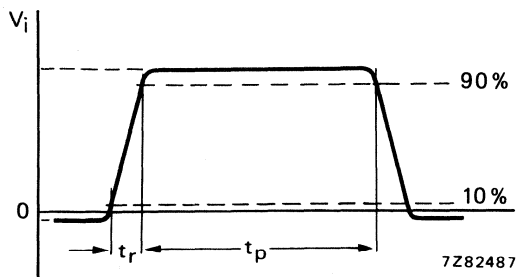

Fig. 2 Input waveform and test circuit for determining delay time and rise time.

$V_i = -0,5 \text{ V to } +9,9 \text{ V}$ ;  $V_{CC} = +30 \text{ V}$ ;  $R_1 = 619 \Omega$ ;  $R_2 = 200 \Omega$ .

Pulse generator:

pulse duration  $t_p \leq 200 \text{ ns}$   
rise time  $t_r \leq 2 \text{ ns}$   
duty factor  $\delta = 0,02$

Oscilloscope:

input impedance  $Z_i$  min.  $100 \text{ k}\Omega$   
input capacitance  $C_i$  max.  $12 \text{ pF}$   
rise time  $t_r$  max.  $5 \text{ ns}$

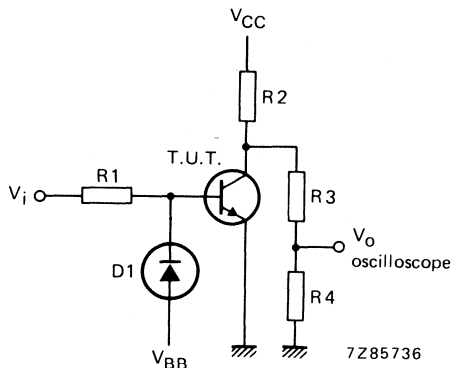
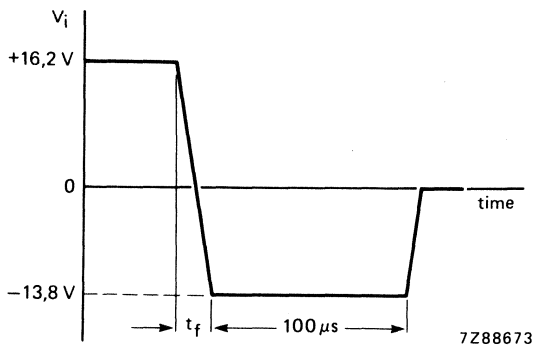

Fig. 3 Input waveform and test circuit for determining storage time and fall time.

$V_{CC} = +30 \text{ V}$ ;  $V_{BB} = -3 \text{ V}$ ;  $R_1 = 1 \text{ k}\Omega$ ;  $R_2 = 200 \Omega$ ;  $R_3 = 20 \text{ k}\Omega$ ;  $R_4 = 50 \Omega$ ;  $D_1 = 1N916$ .

Pulse generator:

fall time  $t_f$  max.  $5 \text{ ns}$

Oscilloscope:

input impedance  $Z_i$  min.  $100 \text{ k}\Omega$   
input capacitance  $C_i$  max.  $12 \text{ pF}$   
rise time  $t_r$  max.  $5 \text{ ns}$



## SILICON PLANAR EPITAXIAL SWITCHING TRANSISTOR

N-P-N transistor in a plastic TO-92 envelope intended for high-speed switching applications.

### QUICK REFERENCE DATA

Collector-base voltage (open emitter)	$V_{CBO}$	max.	40 V
Collector-emitter voltage ( $V_{BE} = 0$ )	$V_{CES}$	max.	40 V
Collector-emitter voltage (open base)	$V_{CEO}$	max.	15 V
Collector current (peak value)	$I_{CM}$	max.	500 mA
Total power dissipation up to $T_{amb} = 25\text{ }^{\circ}\text{C}$	$P_{tot}$	max.	500 mW
D.C. current gain			
$I_C = 10\text{ mA}; V_{CE} = 1\text{ V}$	$h_{FE}$		40 to 120
$I_C = 100\text{ mA}; V_{CE} = 2\text{ V}$	$h_{FE}$		> 20
Transition frequency at $f = 100\text{ MHz}$			
$I_C = 10\text{ mA}; V_{CE} = 10\text{ V}$	$f_T$		> 500 MHz
Storage time			
$I_{Con} = I_{Bon} = -I_{Boff} = 10\text{ mA}$	$t_s$		< 13 ns

### MECHANICAL DATA

Dimensions in mm

Fig. 1 TO-92.

#### Pinning

- 1 = emitter
- 2 = base
- 3 = collector

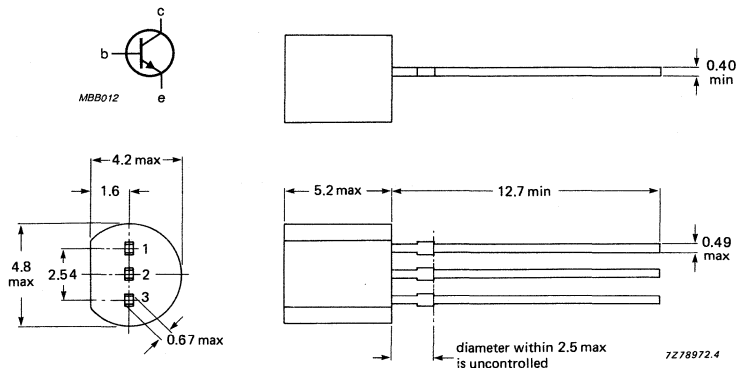

**RATINGS**

Limiting values in accordance with the Absolute Maximum System (IEC 134)

Collector-base voltage (open emitter)	$V_{CB0}$	max.	40 V
Collector-emitter voltage ( $V_{BE} = 0$ )	$V_{CES}$	max.	40 V
Collector-emitter voltage (open base)	$V_{CEO}$	max.	15 V
Emitter-base voltage (open collector)	$V_{EBO}$	max.	4,5 V
Collector current (peak value; $t_p = 10 \mu s$ )	$I_{CM}$	max.	500 mA
Total power dissipation up to $T_{amb} = 25 \text{ }^\circ\text{C}$	$P_{tot}$	max.	500 mW
Storage temperature range	$T_{stg}$		-65 to +150 $^\circ\text{C}$
Junction temperature	$T_j$	max.	150 $^\circ\text{C}$

**THERMAL RESISTANCE**

From junction to ambient in free air	$R_{th\ j-a}$	=	250 K/W
--------------------------------------	---------------	---	---------

**CHARACTERISTICS** $T_{amb} = 25 \text{ }^\circ\text{C}$  unless otherwise specified

Collector cut-off current

$I_E = 0; V_{CB} = 20 \text{ V}$

$I_{CBO} < 400 \text{ nA}$

$I_E = 0; V_{CB} = 20 \text{ V}; T_j = 125 \text{ }^\circ\text{C}$

$I_{CBO} < 30 \mu\text{A}$

Emitter cut-off current

$I_C = 0; V_{EB} = 2 \text{ V}$

$I_{EBO} < 100 \text{ nA}$

Saturation voltages

$I_C = 10 \text{ mA}; I_B = 0,3 \text{ mA}$

$V_{CEsat} < 0,30 \text{ V}$

$I_C = 10 \text{ mA}; I_B = 1 \text{ mA}$

$V_{CEsat} < 0,25 \text{ V}$

$V_{BEsat} \text{ 0,70 to 0,85 V}$

$I_C = 100 \text{ mA}; I_B = 10 \text{ mA}$

$V_{CEsat} < 0,60 \text{ V}$

$V_{BEsat} < 1,50 \text{ V}$

D.C. current gain

$I_C = 10 \text{ mA}; V_{CE} = 1 \text{ V}$

$h_{FE} \text{ 40 to 120}$

$I_C = 10 \text{ mA}; V_{CE} = 1 \text{ V}; T_{amb} = -55 \text{ }^\circ\text{C}$

$h_{FE} > 20$

$I_C = 100 \text{ mA}; V_{CE} = 2 \text{ V}$

$h_{FE} > 20$

Transition frequency at  $f = 100 \text{ MHz}$ 

$I_C = 10 \text{ mA}; V_{CE} = 10 \text{ V}$

$f_T > 500 \text{ MHz}$

Collector capacitance at  $f = 1 \text{ MHz}$ 

$I_E = I_e = 0; V_{CB} = 5 \text{ V}$

$C_c < 4 \text{ pF}$

Emitter capacitance at  $f = 1 \text{ MHz}$ 

$I_C = I_c = 0; V_{EB} = 1 \text{ V}$

$C_e < 4,5 \text{ pF}$

**Switching times**

Storage time (see Fig. 2)

$I_{Con} = I_{Bon} = -I_{Boff} = 10 \text{ mA}$

$t_s \text{ typ. 6 ns}$

$t_s < 13 \text{ ns}$

Pulse generator:

$$\begin{aligned}
 t_r &< 1 \text{ ns} \\
 t_p &> 300 \text{ ns} \\
 \delta &< 0,02 \\
 R_s &= 50 \Omega
 \end{aligned}$$

Oscilloscope:

$$\begin{aligned}
 R_i &= 50 \Omega \\
 t_r &< 1 \text{ ns}
 \end{aligned}$$

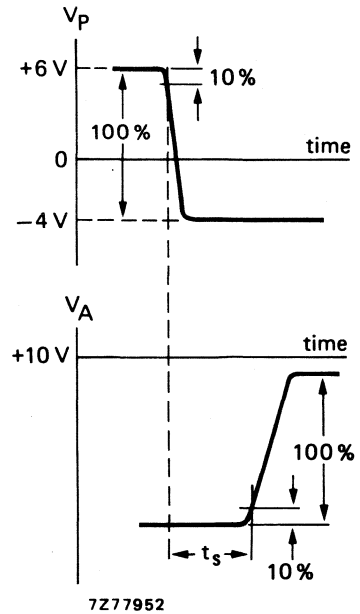
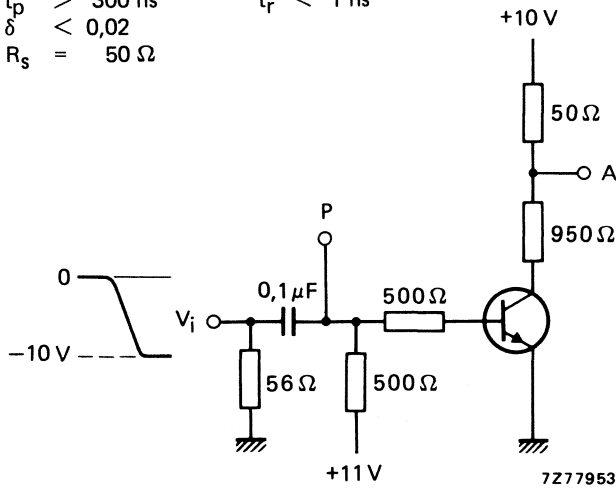

Fig. 2 Test circuit and waveforms.

Turn-on time (see Fig. 3)

from  $-V_{BEoff} = 1,5 \text{ V}$  to  $I_{Con} = 10 \text{ mA}$ ;  $I_{Bon} = 3 \text{ mA}$   
 from  $-V_{BEoff} = 2,25 \text{ V}$  to  $I_{Con} = 100 \text{ mA}$ ;  $I_{Bon} = 40 \text{ mA}$

$$\begin{aligned}
 t_{on} &< 12 \text{ ns} \\
 t_{on} &< 7 \text{ ns}
 \end{aligned}$$

Turn-off time (see Fig. 3)

$I_{Con} = 10 \text{ mA}$ ;  $I_{Bon} = 3 \text{ mA}$ ;  $-I_{Boff} = 1,5 \text{ mA}$   
 $I_{Con} = 100 \text{ mA}$ ;  $I_{Bon} = 40 \text{ mA}$ ;  $-I_{Boff} = 20 \text{ mA}$

$$\begin{aligned}
 t_{off} &< 18 \text{ ns} \\
 t_{off} &< 21 \text{ ns}
 \end{aligned}$$

Pulse generator:

$t_r < 1 \text{ ns}$

$t_p > 300 \text{ ns}$

$\delta < 0,02$

$R_s = 50 \Omega$

Oscilloscope:

$R_i = 50 \Omega$

$t_r < 1 \text{ ns}$

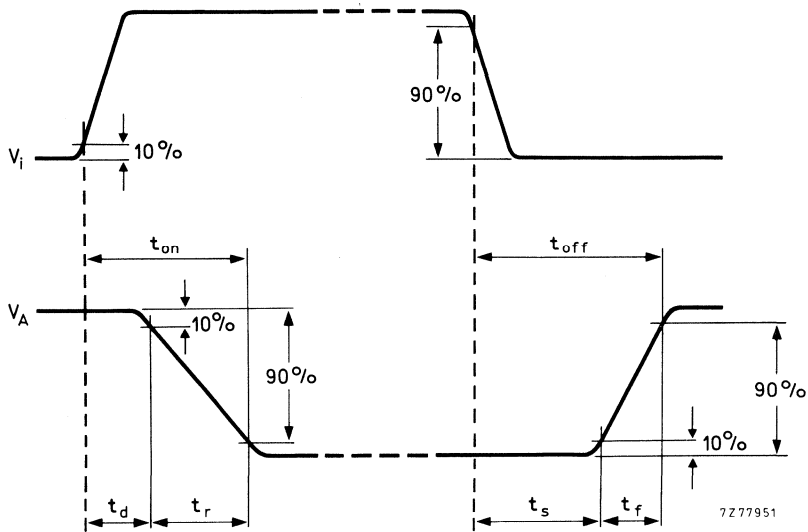
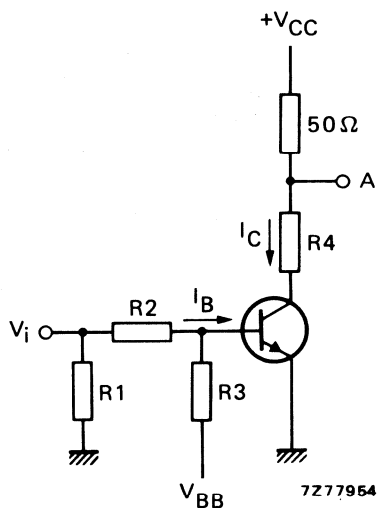

Fig. 3 Test circuit and waveforms.

$I_{Con}$ mA	$I_{Bon}$ mA	$I_{Boff}$ mA	$V_{CC}$ V	$R_1$ $\Omega$	$R_2; R_3$ k $\Omega$	$R_4$ $\Omega$	turn-on time			turn-off time	
							$V_{BB}$ V	$V_{BE}$ V	$V_i$ V	$V_{BB}$ V	$V_i$ V
10	3	-1,5	3	50	3,30	220	-3,0	-1,50	15	12,0	-15
100	40	-20	6	56	0,33	0	-4,5	-2,25	20	15,3	-20



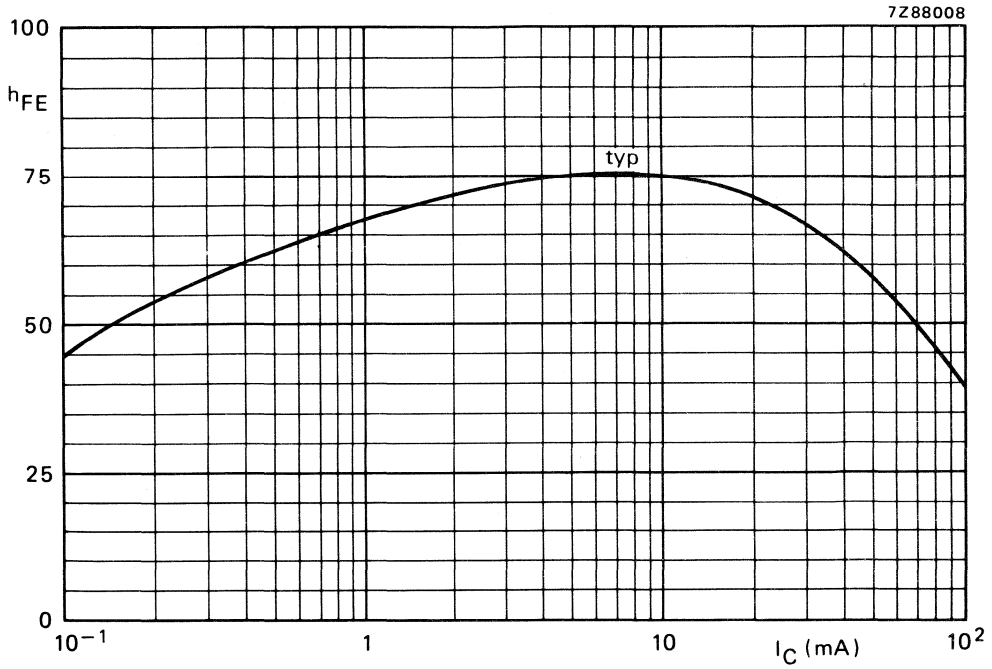

Fig. 4  $V_{CE} = 1$  V;  $T_j = 25$  °C.

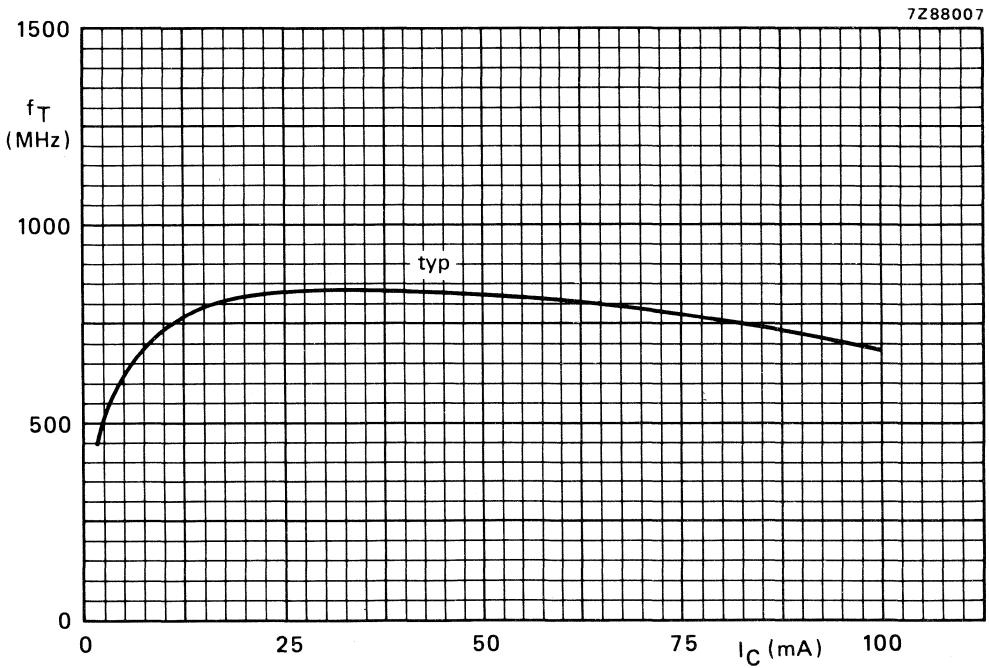

Fig. 5  $V_{CE} = 10$  V;  $T_j = 25$  °C.

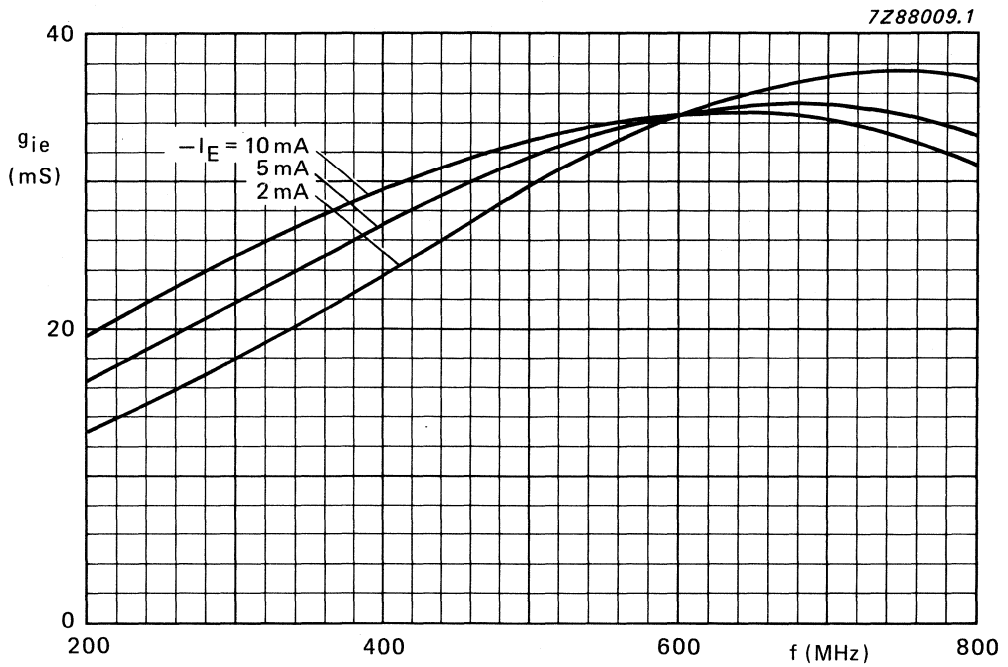

Fig. 6  $V_{CB} = 10\text{ V}$ ;  $T_{amb} = 25\text{ }^\circ\text{C}$ ; typical values.

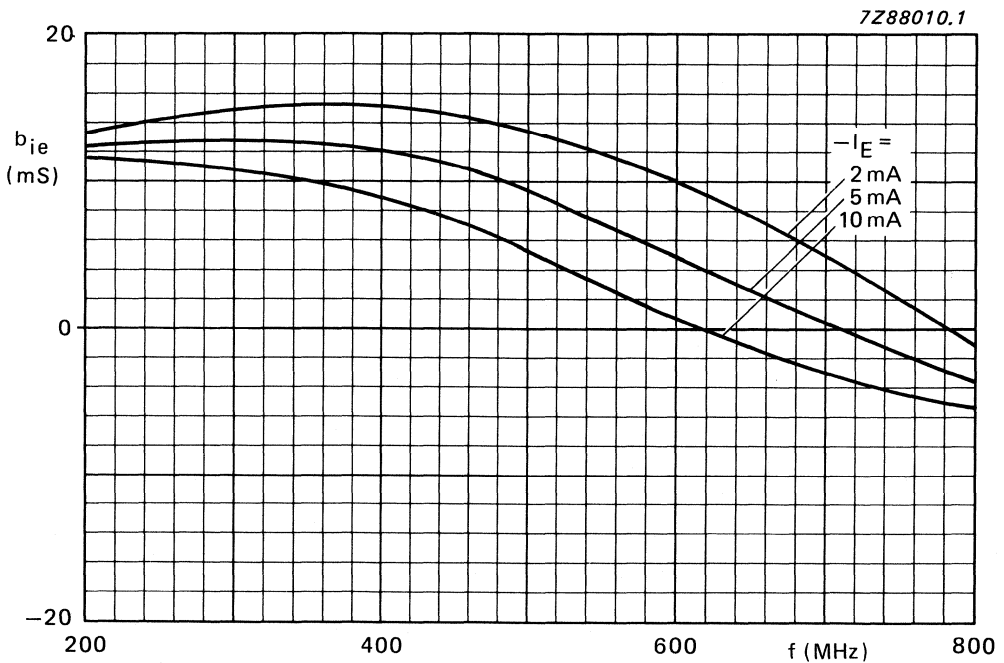

Fig. 7  $V_{CB} = 10\text{ V}$ ;  $T_{amb} = 25\text{ }^\circ\text{C}$ ; typical values.

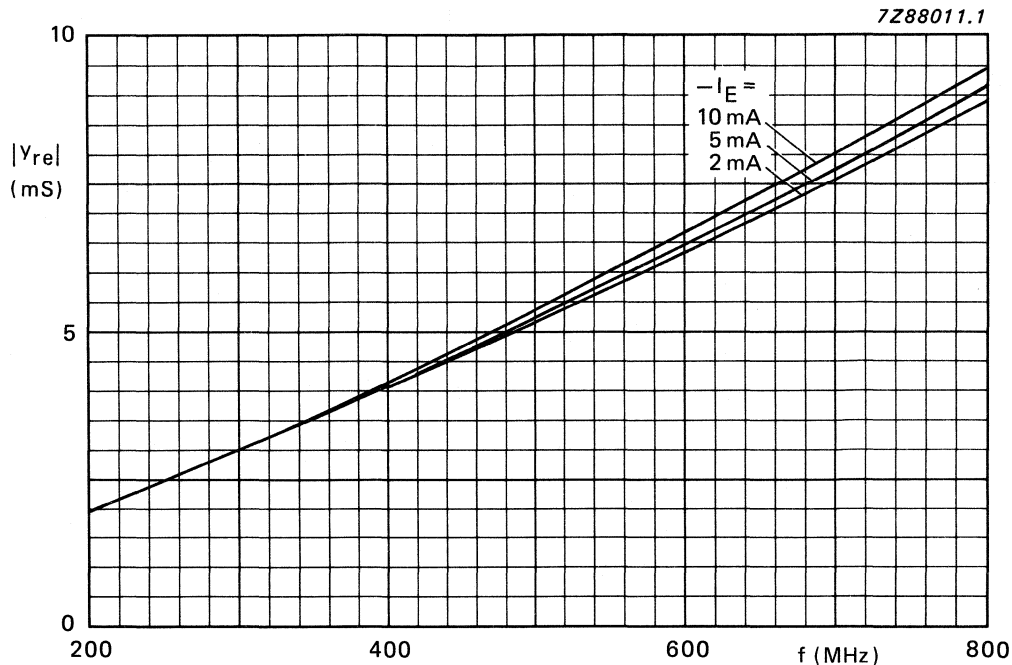

Fig. 8  $V_{CB} = 10 \text{ V}$ ;  $T_{amb} = 25 \text{ }^\circ\text{C}$ ; typical values.

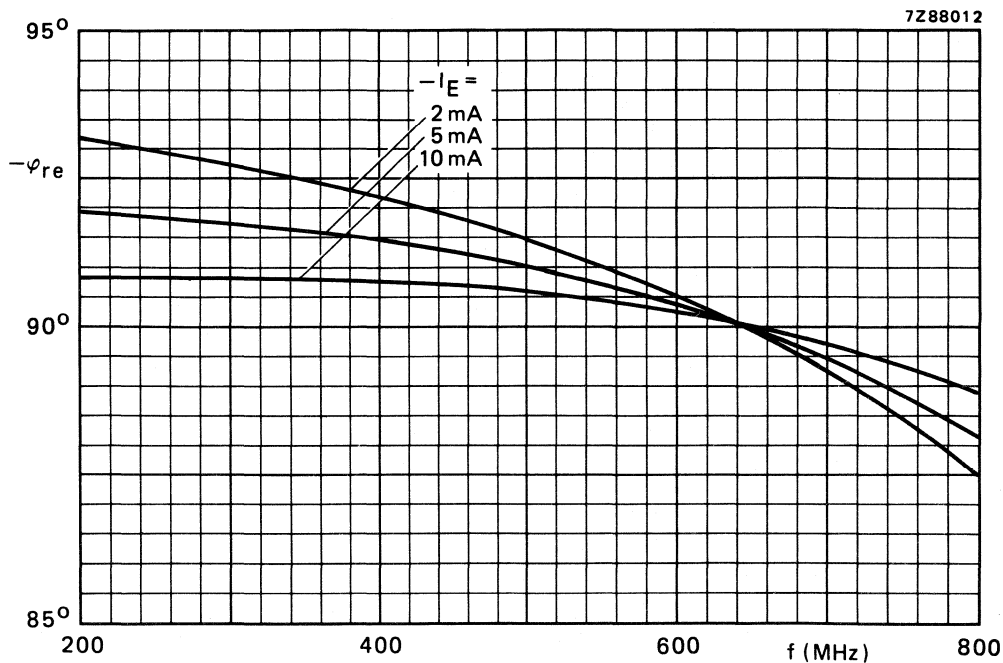

Fig. 9  $V_{CB} = 10 \text{ V}$ ;  $T_{amb} = 25 \text{ }^\circ\text{C}$ ; typical values.

7Z88015.1

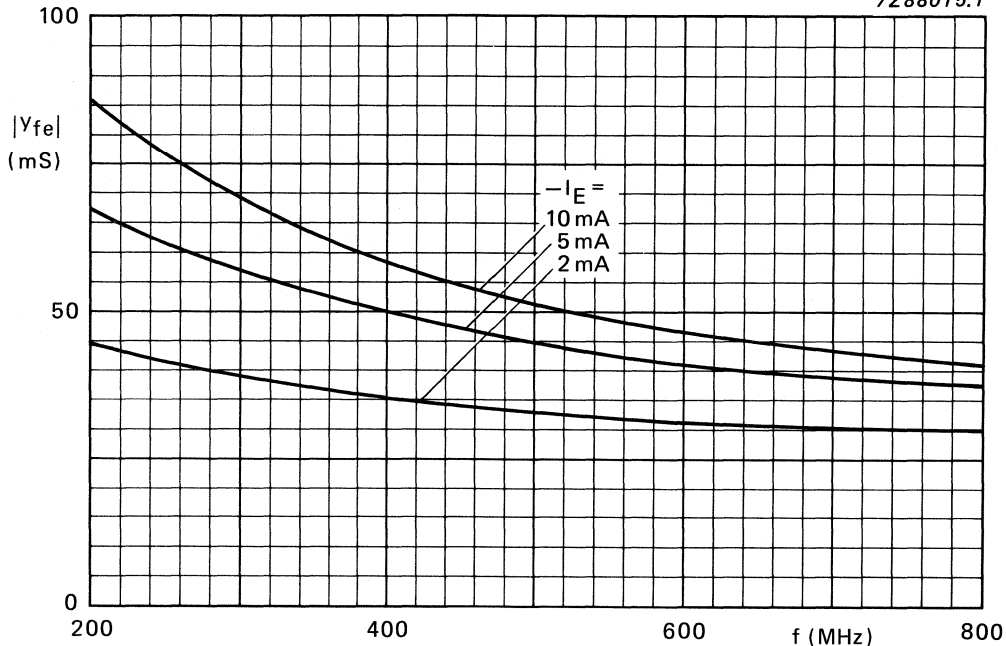

Fig. 10  $V_{CB} = 10 \text{ V}$ ;  $T_{amb} = 25 \text{ }^\circ\text{C}$ ; typical values.

7Z88013

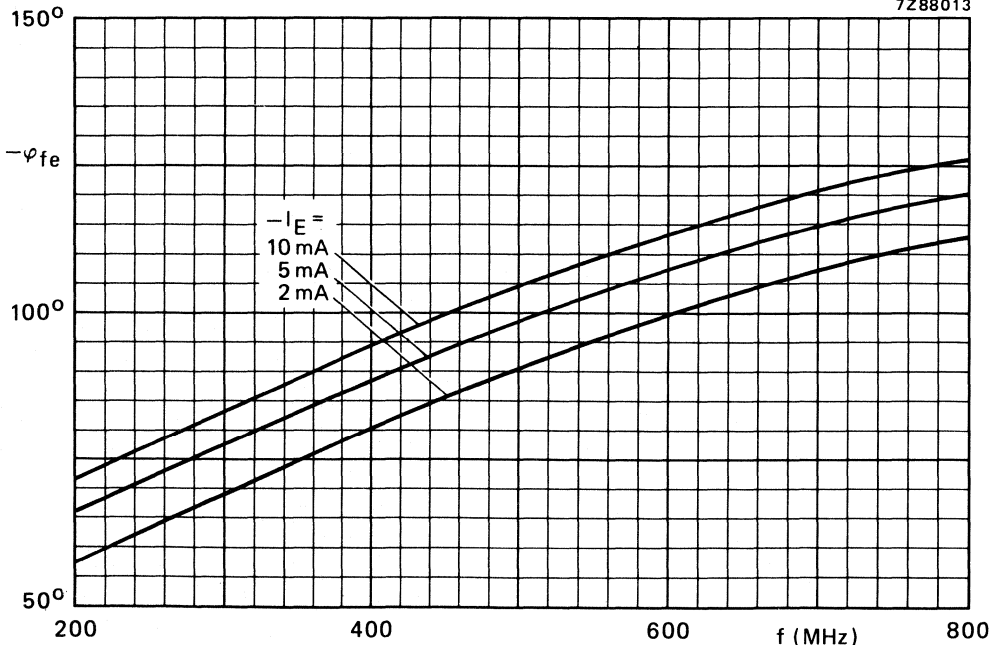

Fig. 11  $V_{CB} = 10 \text{ V}$ ;  $T_{amb} = 25 \text{ }^\circ\text{C}$ ; typical values.

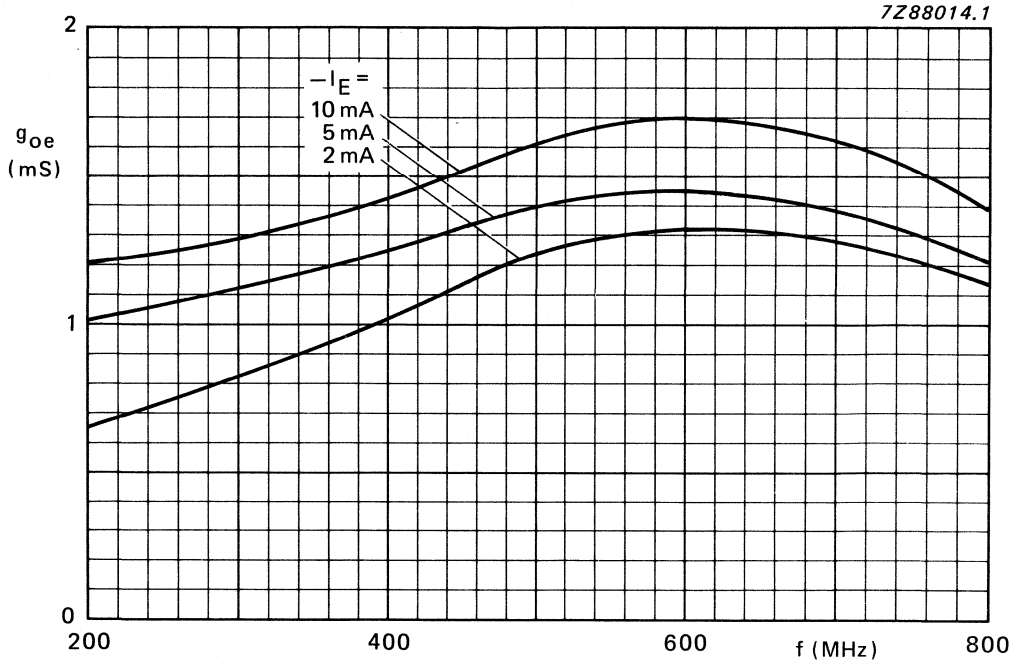

Fig. 12  $V_{CB} = 10\text{ V}$ ;  $T_{amb} = 25\text{ }^\circ\text{C}$ ; typical values.

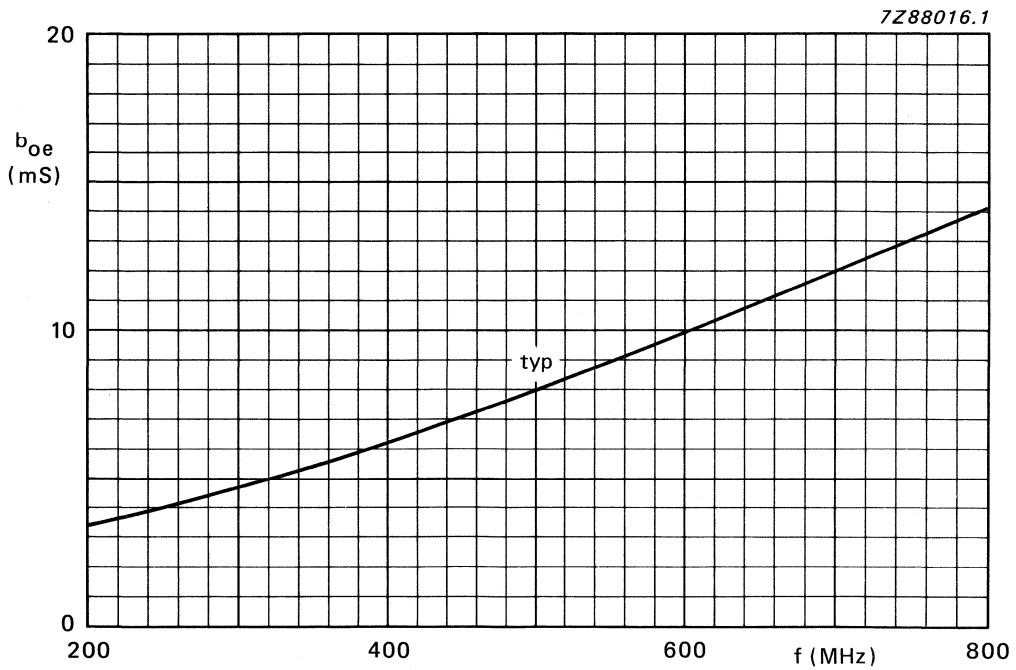

Fig. 13  $V_{CB} = 10\text{ V}$ ;  $-I_E = 2\text{ to }10\text{ mA}$ ;  $T_{amb} = 25\text{ }^\circ\text{C}$ .





## SILICON PLANAR EPITAXIAL TRANSISTORS

P-N-P medium power transistors in plastic TO-92 envelopes, primarily designed for high-speed switching and driver applications for industrial service.

### QUICK REFERENCE DATA

Collector-base voltage (open emitter)		$-V_{CBO}$	max.	60 V
Collector-emitter voltage (open base)	PH2907	$-V_{CEO}$	max.	40 V
	PH2907A	$-V_{CEO}$	max.	60 V
Collector current (d.c.)		$-I_C$	max.	600 mA
Total power dissipation up to $T_{amb} = 25\text{ }^\circ\text{C}$		$P_{tot}$	max.	625 mW
Junction temperature		$T_j$	max.	150 $^\circ\text{C}$
D.C. current gain at $T_j = 25\text{ }^\circ\text{C}$		$h_{FE}$		100 to 300
$-I_C = 150\text{ mA}; -V_{CE} = 10\text{ V}$				
Transition frequency at $f = 100\text{ MHz}$		$f_T$	>	200 MHz
$-I_C = 50\text{ mA}; -V_{CE} = 20\text{ V}; T_j = 25\text{ }^\circ\text{C}$				
Storage time		$t_s$	<	80 ns
$-I_{Con} = 150\text{ mA}; -I_{Bon} = I_{Boff} = 15\text{ mA}$				

### MECHANICAL DATA

Dimensions in mm

Fig. 1 TO-92.

#### Pinning

- 1 = emitter
- 2 = base
- 3 = collector

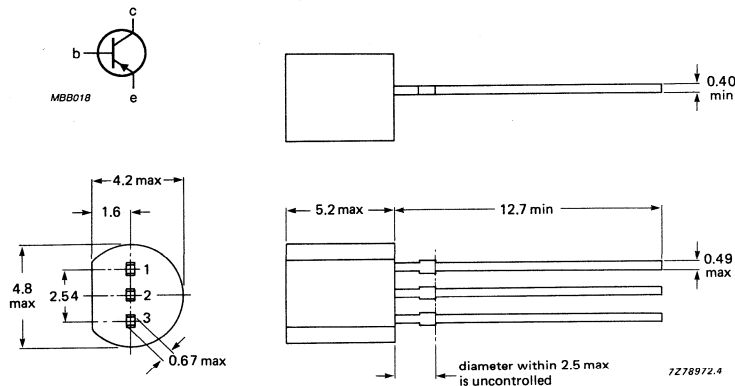

**RATINGS**

Limiting values in accordance with the Absolute Maximum System (IEC 134)

Collector-base voltage (open emitter)		$-V_{CBO}$	max.	60 V
Collector-emitter voltage (open base)	PH2907	$-V_{CEO}$	max.	40 V
	PH2907A	$-V_{CEO}$	max.	60 V
Emitter-base voltage (open collector)		$-V_{EBO}$	max.	5 V
Collector current (d.c.)		$-I_C$	max.	600 mA
Total power dissipation up to $T_{amb} = 25\text{ }^\circ\text{C}$		$P_{tot}$	max.	625 mW
Storage temperature range		$T_{stg}$		-65 to + 150 $^\circ\text{C}$
Junction temperature		$T_j$	max.	150 $^\circ\text{C}$

**THERMAL RESISTANCE**

From junction to ambient in free air		$R_{th\ j-a}$	=	200 K/W
--------------------------------------	--	---------------	---	---------



## CHARACTERISTICS

 $T_{amb} = 25\text{ }^{\circ}\text{C}$  unless otherwise specified

Collector cut-off current

$I_E = 0; -V_{CB} = 50\text{ V}$

		2N2907	2N2907A	
$-I_{CBO}$	<	20	10	nA
$-I_{CBO}$	<	20	10	$\mu\text{A}$
$-I_{CEX}$	<	50	50	nA
$I_{BEX}$	<	50	50	nA
$-V_{(BR)CBO}$	>	60	60	V
$-V_{(BR)CEO}$	>	40	60	V
$-V_{(BR)EBO}$	>	5	5	V
$-V_{CEsat}$	<	0,4	0,4	V
$-V_{BEsat}$	<	1,3	1,3	V
$-V_{CEsat}$	<	1,6	1,6	V
$-V_{BEsat}$	<	2,6	2,6	V
$h_{FE}$	>	35	75	
$h_{FE}$	>	50	100	
$h_{FE}$	>	75	100	
$h_{FE}$	>	100	100	
$h_{FE}$	<	300	300	
$h_{FE}$	>	30	50	
$C_c$	<	8		pF
$C_e$	<	30		pF
$f_T$	>	200		MHz

$I_E = 0; -V_{CB} = 50\text{ V}; T_{amb} = 150\text{ }^{\circ}\text{C}$

$+V_{BE} = 0,5\text{ V}; -V_{CE} = 30\text{ V}$

Base current

$+V_{BE} = 0,5\text{ V}; -V_{CE} = 30\text{ V}$

Collector-base breakdown voltage

open emitter;  $-I_C = 10\text{ }\mu\text{A}$

Collector-emitter breakdown voltage\*

open base;  $-I_C = 10\text{ }\mu\text{A}$

Emitter-base breakdown voltage

open collector;  $-I_E = 10\text{ }\mu\text{A}$

Saturation voltages\*

$-I_C = 150\text{ mA}; -I_B = 15\text{ mA}$

$-I_C = 500\text{ mA}; -I_B = 50\text{ mA}$

D.C. current gain

$-I_C = 0,1\text{ mA}; -V_{CE} = 10\text{ V}$

$-I_C = 1\text{ mA}; -V_{CE} = 10\text{ V}$

$-I_C = 10\text{ mA}; -V_{CE} = 10\text{ V}$

$-I_C = 150\text{ mA}; -V_{CE} = 10\text{ V}^*$

$-I_C = 500\text{ mA}; -V_{CE} = 10\text{ V}^*$

Collector capacitance at  $f = 100\text{ kHz}$ 

$I_E = I_e = 0; -V_{CB} = 10\text{ V}$

Emitter capacitance at  $f = 100\text{ kHz}$ 

$I_C = I_c = 0; -V_{EB} = 2\text{ V}$

Transition frequency at  $f = 100\text{ MHz}$ 

$-I_C = 50\text{ mA}; -V_{CE} = 20\text{ V}^*$

\* Measured under pulse conditions to avoid excessive dissipation:  $t_p \leq 300\text{ }\mu\text{s}$ ;  $\delta \leq 0,02$ .

Turn-on time (see Fig. 2)

when switched to  $-I_{Con} = 150 \text{ mA}$ ;  $-I_{Bon} = 15 \text{ mA}$

delay time

$$t_d < 10 \text{ ns}$$

rise time

$$t_r < 40 \text{ ns}$$

turn-on time

$$t_{on} < 45 \text{ ns}$$

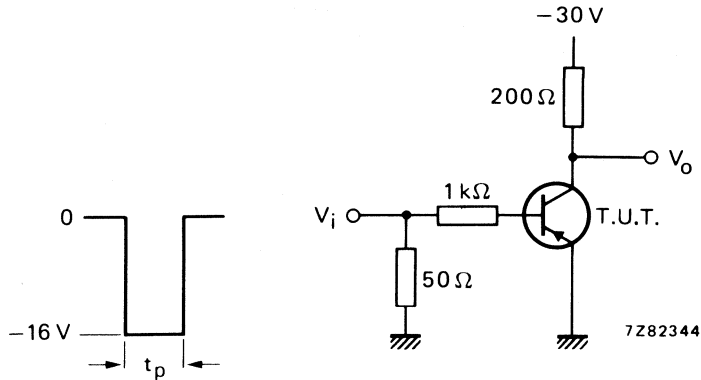

Fig. 2 Input waveform and test circuit for determining delay, rise and turn-on time.

Turn-off time (see Fig. 3)

when switched from  $-I_{Con} = 150 \text{ mA}$ ;  $-I_{Bon} = 15 \text{ mA}$   
to cut-off with  $+I_{Boff} = 15 \text{ mA}$

storage time

$$t_s < 80 \text{ ns}$$

fall time

$$t_f < 30 \text{ ns}$$

turn-off time

$$t_{off} < 100 \text{ ns}$$

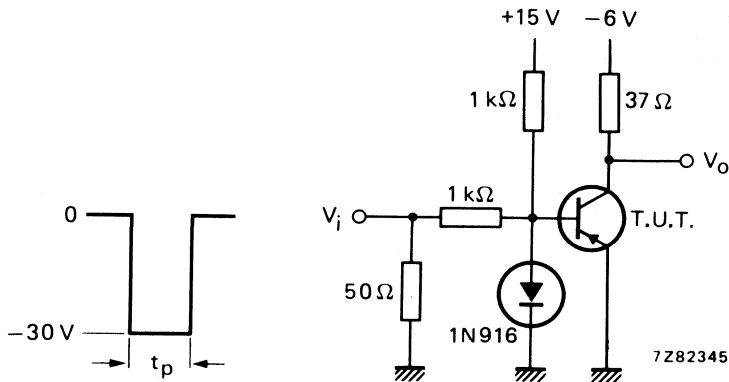

Fig. 3 Input waveform and test circuit for determining storage, fall and turn-off time.

Pulse generator (see Figs 2 and 3)

frequency	$f$	=	150 Hz
pulse duration	$t_p$	=	200 ns
rise time	$t_r$	$\leq$	2 ns
output impedance	$Z_o$	=	50 $\Omega$

Oscilloscope (see Figs 2 and 3)

rise time	$t_r$	$\leq$	5 ns
input impedance	$Z_i$	$\leq$	10 M $\Omega$



## SILICON P-N-P HIGH-VOLTAGE TRANSISTORS

P-N-P high-voltage small-signal transistors, primarily intended for use in telephony applications and encapsulated in a TO-92 envelope.

### QUICK REFERENCE DATA

		PH5415	PH5416
Collector-base voltage (open emitter)	$-V_{CBO}$ max.	200	350 V
Collector-emitter voltage (open base)	$-V_{CEO}$ max.	200	300 V
Collector current	$-I_C$ max.	1,0	1,0 A
Total power dissipation up to $T_{amb} = 25^\circ\text{C}$	$P_{tot}$ max.	625	625 mW
Junction temperature	$T_j$ max.	150	150 $^\circ\text{C}$
Collector-emitter saturation voltage $-I_C = 50\text{ mA}; -I_B = 5\text{ mA}$	$-V_{CEsat} <$	0,8	0,8 V
D.C. current gain $-I_C = 50\text{ mA}; -V_{CE} = 10\text{ V}$	$h_{FE} >$	30	30
	$h_{FE} <$	150	120

### MECHANICAL DATA

Dimension in mm

Fig. 1 TO-92.

#### Pinning

- 1 = emitter
- 2 = base
- 3 = collector

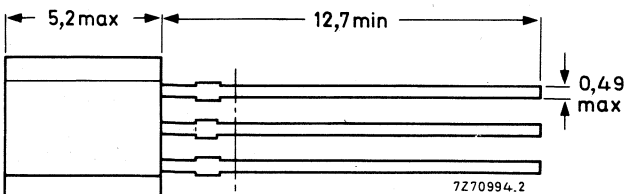
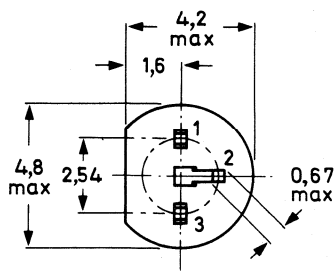
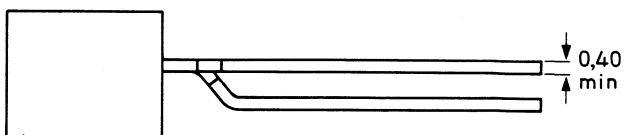
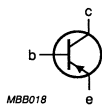

diameter within 2,5 max is uncontrolled

### RATINGS

Limiting values in accordance with the Absolute Maximum System (IEC 134)

			PH5415	PH5416
Collector-base voltage (open emitter)	$-V_{CB0}$	max.	200	350 V
Collector-emitter voltage (open base)	$-V_{CEO}$	max.	200	300 V
Emitter-base voltage (open collector)	$-V_{EBO}$	max.	4,0	6,0 V
Collector current (d.c.)	$-I_C$	max.	1,0	A
Base current	$-I_B$	max.	0,5	A
Total power dissipation up to $T_{amb} = 25\text{ }^\circ\text{C}$	$P_{tot}$	max.	625	mW
Junction temperature	$T_j$	max.	150	$^\circ\text{C}$
Storage temperature range	$T_{stg}$		-65 to 150	$^\circ\text{C}$

### THERMAL RESISTANCE

From junction to ambient in free air	$R_{th\ j-a}$	=	200	K/W
--------------------------------------	---------------	---	-----	-----

### CHARACTERISTICS

$T_j = 25\text{ }^\circ\text{C}$  unless otherwise specified

			PH5415	PH5416
Collector cut-off currents				
$I_E = 0; -V_{CB} = 175\text{ V}$	$-I_{CBO}$	<	0,1	$\mu\text{A}$
$I_E = 0; -V_{CB} = 280\text{ V}$	$-I_{CBO}$	<		0,1 $\mu\text{A}$
$I_B = 0; -V_{CE} = 150\text{ V}$	$-I_{CEO}$	<	1,0	$\mu\text{A}$
$I_B = 0; -V_{CE} = 250\text{ V}$	$-I_{CEO}$	<		1,0 $\mu\text{A}$
Emitter cut-off current				
$I_C = 0; -V_{EB} = 4\text{ V}$	$-I_{EBO}$	<	1,0	$\mu\text{A}$
$I_C = 0; -V_{EB} = 6\text{ V}$	$-I_{EBO}$	<		1,0 $\mu\text{A}$
Collector-emitter sustaining voltage				
$I_B = 0; -I_C = 50\text{ mA}$	$-V_{CEO_{sust}}$	>	200	300 V
Saturation voltages				
$-I_C = 50\text{ mA}; -I_B = 5\text{ mA}$	$-V_{CE_{sat}}$	<	0,8	0,8 V
	$-V_{BE_{sat}}$	<	1,0	1,0 V
D.C. current gain				
$-I_C = 50\text{ mA}; -V_{CE} = 10\text{ V}$	$h_{FE}$	>	30	30
	$h_{FE}$	<	150	120
Transition frequency at $f = 5\text{ MHz}$				
$-I_C = 10\text{ mA}; -V_{CE} = 10\text{ V}; T_{amb} = 25\text{ }^\circ\text{C}$	$f_T$	>		15 MHz
Small-signal current gain at $f = 5\text{ MHz}$				
$-I_C = 10\text{ mA}; -V_{CE} = 10\text{ V}; T_{amb} = 25\text{ }^\circ\text{C}$	$h_{fe}$	>		25
Real part (Re) of input impedance ( $h_{ie}$ )				
$-V_{CE} = 10\text{ V}; -I_C = 5\text{ mA}; f = 1\text{ MHz}; T_{amb} = 25\text{ }^\circ\text{C}$	$\text{Re}(h_{ie})$	<	300	$\Omega$
Input capacitance at $f = 1\text{ MHz}$				
$I_C = 0; -V_{EB} = 5\text{ V}; T_{amb} = 25\text{ }^\circ\text{C}$	$C_e$	<	75	pF
Output capacitance at $f = 1\text{ MHz}$				
$I_E = 0; -V_{CB} = 10\text{ V}; T_{amb} = 25\text{ }^\circ\text{C}$	$C_c$	<	15	pF



## SILICON PLANAR EPITAXIAL TRANSISTORS

N-P-N silicon planar epitaxial transistors in a plastic TO-92 envelope primarily intended for linear and switching applications.

P-N-P complement is PN2907/2907A.

### QUICK REFERENCE DATA

			PN2222	PN2222A
Collector-emitter voltage (open base)	$V_{CEO}$	max.	30	40 V
Collector-base voltage (open emitter)	$V_{CBO}$	max.	60	75 V
Collector current (d.c.)	$I_C$	max.	600	mA
Total power dissipation up to $T_{amb} = 25\text{ }^\circ\text{C}$	$P_{tot}$	max.	625	mW
Collector-emitter saturation voltage $I_C = 150\text{ mA}; I_B = 15\text{ mA}$	$V_{CEsat}$	max.	0,4	0,3 V
D.C. current gain $I_C = 150\text{ mA}; V_{CE} = 10\text{ V}$	$h_{FE}$	min. max.	100 300	

### MECHANICAL DATA

Dimensions in mm

Fig. 1 TO-92.

#### Pinning

- 1 = collector
- 2 = base
- 3 = emitter

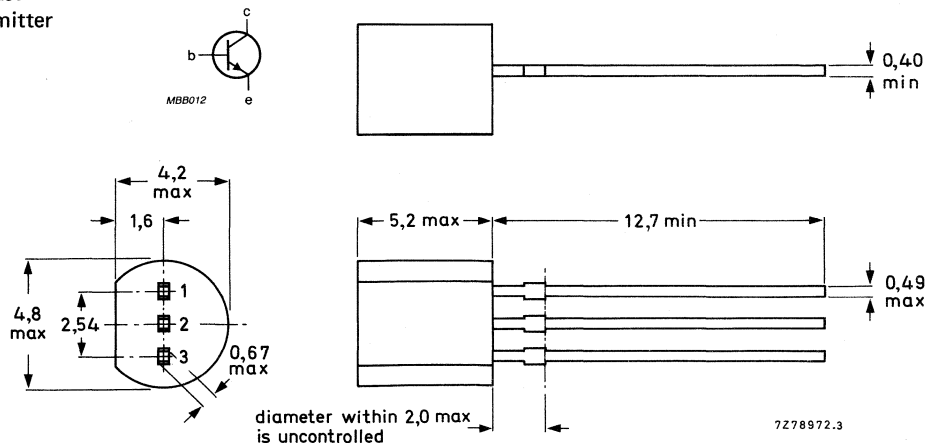

### RATINGS

Limiting values in accordance with the Absolute Maximum System (IEC 134)

			PN2222	PN2222A
Collector-emitter voltage (open base)	$V_{CEO}$	max.	30	40 V
Collector-base voltage (open emitter)	$V_{CBO}$	max.	60	75 V
Emitter-base voltage (open collector)	$V_{EBO}$	max.	5,0	6,0 V
Collector current (d.c.)	$I_C$	max.	600	mA
Total power dissipation up to $T_{amb} = 25\text{ }^{\circ}\text{C}$	$P_{tot}$	max.	625	mW
Storage temperature range	$T_{stg}$		-65 to +150	$^{\circ}\text{C}$
Junction temperature	$T_j$	max.	150	$^{\circ}\text{C}$

### THERMAL RESISTANCE

From junction to ambient in free air	$R_{th\ j-a}$	=	200	K/W
--------------------------------------	---------------	---	-----	-----

### CHARACTERISTICS

$T_j = 25\text{ }^{\circ}\text{C}$  unless otherwise specified

			PN2222	PN2222A
Collector-emitter breakdown voltage $I_B = 0; I_C = 10\text{ mA}$	$V_{(BR)CEO}$	min.	30	40 V
Collector-base breakdown voltage $I_E = 0; I_C = 10\text{ }\mu\text{A}$	$V_{(BR)CBO}$	min.	60	75 V
Emitter-base breakdown voltage $I_E = 10\text{ }\mu\text{A}; I_C = 0$	$V_{(BR)EBO}$	min.	5,0	6,0 V
Base cut-off current $V_{CE} = 60\text{ V}; -V_{BE} = 3\text{ V}$	$I_{BEX}$	max.	—	20 nA
Collector cut-off current $V_{CE} = 60\text{ V}; -V_{BE} = 3\text{ V}$	$I_{CEX}$	max.	—	10 nA
Emitter cut-off current $I_C = 0; V_{EB} = 3\text{ V}$	$I_{EBO}$	max.	—	10 nA
Collector cut-off current $I_E = 0; V_{CB} = 50\text{ V}$	$I_{CBO}$	max.	10	— nA
$I_E = 0; V_{CB} = 60\text{ V}$	$I_{CBO}$	max.	—	10 nA
$I_E = 0; V_{CB} = 50\text{ V}; T_{amb} = 125\text{ }^{\circ}\text{C}$	$I_{CBO}$	max.	10	— $\mu\text{A}$
$I_E = 0; V_{CB} = 60\text{ V}; T_{amb} = 125\text{ }^{\circ}\text{C}$	$I_{CBO}$	max.	—	10 $\mu\text{A}$

			PN2222	PN2222A
<b>D.C. current gain</b>				
$I_C = 0,1 \text{ mA}; V_{CE} = 10 \text{ V}$	$h_{FE}$	min.	35	
$I_C = 1 \text{ mA}; V_{CE} = 10 \text{ V}$	$h_{FE}$	min.	50	
$I_C = 10 \text{ mA}; V_{CE} = 10 \text{ V}$	$h_{FE}$	min.	75	
$I_C = 10 \text{ mA}; V_{CE} = 10 \text{ V}; T_{amb} = -55 \text{ }^\circ\text{C}$	$h_{FE}$	min.	—	35
$I_C = 150 \text{ mA}; V_{CE} = 10 \text{ V}$	$h_{FE}$	min.	100	
		max.	300	
$I_C = 150 \text{ mA}; V_{CE} = 1 \text{ V}$	$h_{FE}$	min.	30	50
$I_C = 500 \text{ mA}; V_{CE} = 10 \text{ V}$	$h_{FE}$	min.	30	40
<b>Saturation voltages</b>				
$I_C = 150 \text{ mA}; I_B = 15 \text{ mA}$	$V_{CEsat}$	max.	0,4	0,3 V
$I_C = 500 \text{ mA}; I_B = 50 \text{ mA}$	$V_{CEsat}$	min.	1,6	1,0 V
$I_C = 150 \text{ mA}; I_B = 15 \text{ mA}$	$V_{BEsat}$	max.	1,3	— V
$I_C = 150 \text{ mA}; I_B = 15 \text{ mA}$	$V_{BEsat}$	min.		0,6 V
		max.		1,2 V
$I_C = 500 \text{ mA}; I_B = 50 \text{ mA}$	$V_{BEsat}$	max.	2,6	2,0 V
<b>Transition frequency at <math>f = 100 \text{ MHz}</math></b>				
$I_C = 20 \text{ mA}; V_{CE} = 20 \text{ V}; T_{amb} = 25 \text{ }^\circ\text{C}$	$f_T$	min.	250	300 MHz
<b>Output capacitance at <math>f = 1 \text{ MHz}</math></b>				
$I_E = 0; V_{CB} = 10 \text{ V}$	$C_c$	max.	8,0	pF
<b>Input capacitance at <math>f = 1 \text{ MHz}</math></b>				
$I_C = 0; V_{EB} = 0,5 \text{ V}$	$C_e$	max.	30	25 pF
<b>Input impedance at <math>f = 1 \text{ kHz}</math></b>				
$I_C = 1 \text{ mA}; V_{CE} = 10 \text{ V}; T_{amb} = 25 \text{ }^\circ\text{C}$	$h_{ie}$	min.	—	2,0 k $\Omega$
		max.	—	8,0 k $\Omega$
$I_C = 10 \text{ mA}; V_{CE} = 10 \text{ V}; T_{amb} = 25 \text{ }^\circ\text{C}$	$h_{ie}$	min.	—	0,25 k $\Omega$
		max.	—	1,25 k $\Omega$
<b>Voltage feedback ratio at <math>f = 1 \text{ kHz}</math></b>				
$I_C = 1 \text{ mA}; V_{CE} = 10 \text{ V}; T_{amb} = 25 \text{ }^\circ\text{C}$	$h_{re}$	max.	—	$8,0 \times 10^{-4}$
$I_C = 10 \text{ mA}; V_{CE} = 10 \text{ V}; T_{amb} = 25 \text{ }^\circ\text{C}$	$h_{re}$	max.	—	$4,0 \times 10^{-4}$
<b>Small-signal current gain at <math>f = 1 \text{ kHz}</math></b>				
$I_C = 1 \text{ mA}; V_{CE} = 10 \text{ V}; T_{amb} = 25 \text{ }^\circ\text{C}$	$h_{fe}$	min.	—	50
		max.	—	300
$I_C = 10 \text{ mA}; V_{CE} = 10 \text{ V}; T_{amb} = 25 \text{ }^\circ\text{C}$	$h_{fe}$	min.	—	75
		max.	—	375
<b>Output admittance at <math>f = 1 \text{ kHz}</math></b>				
$I_C = 1 \text{ mA}; V_{CE} = 10 \text{ V}; T_{amb} = 25 \text{ }^\circ\text{C}$	$h_{oe}$	min.	—	5,0 $\mu\text{mhos}$
		max.	—	35 $\mu\text{mhos}$
$I_C = 10 \text{ mA}; V_{CE} = 10 \text{ V}; T_{amb} = 25 \text{ }^\circ\text{C}$	$h_{oe}$	min.	—	25 $\mu\text{mhos}$
		max.	—	200 $\mu\text{mhos}$

Noise figure at  $R_S = 1\text{ k}\Omega$   
 $I_C = 100\ \mu\text{A}$ ;  $V_{CE} = 10\text{ V}$ ;  
 $f = 1\text{ kHz}$ ;  $T_{\text{amb}} = 25\text{ }^\circ\text{C}$

Switching times at  $T_{\text{amb}} = 25\text{ }^\circ\text{C}$

Turn-on time (see Fig. 2)

$I_C = 150\text{ mA}$ ;  $I_{\text{Bon}} = 15\text{ mA}$   
 $V_{CC} = 30\text{ V}$ ;  $V_{\text{EB(off)}} = 0,5\text{ V}$

delay time

rise time

Turn-off time (see Fig. 3)

$I_C = 150\text{ mA}$ ;  $I_{\text{Bon}} = I_{\text{Boff}} = 15\text{ mA}$   
 $V_{CC} = 30\text{ V}$

storage time

fall time

		PN2222	PN2222A
F	max.	—	4,0 dB
$t_d$	max.	—	10 ns
$t_r$	max.	—	25 ns
$t_s$	max.	—	225 ns
$t_f$	max.	—	60 ns

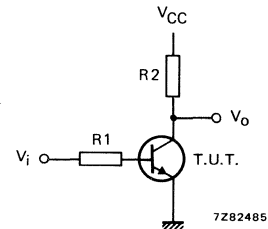
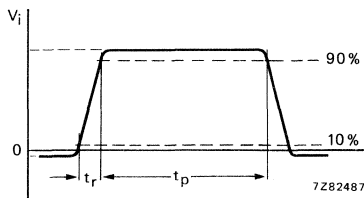

Fig. 2 Input waveform and test circuit for determining delay time and rise time.

$V_i = -0,5\text{ V to } +9,9\text{ V}$ ;  $V_{CC} = +30\text{ V}$ ;  $R_1 = 619\ \Omega$ ;  $R_2 = 200\ \Omega$ .

Pulse generator:

pulse duration  $t_p \leq 200\text{ ns}$   
 rise time  $t_r \leq 2\text{ ns}$   
 duty factor  $\delta = 0,02$

Oscilloscope:

input impedance  $Z_i > 100\text{ k}\Omega$   
 input capacitance  $C_i < 12\text{ pF}$   
 rise time  $t_r < 5\text{ ns}$

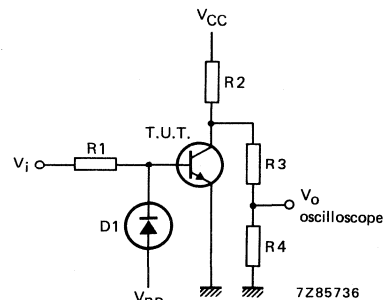
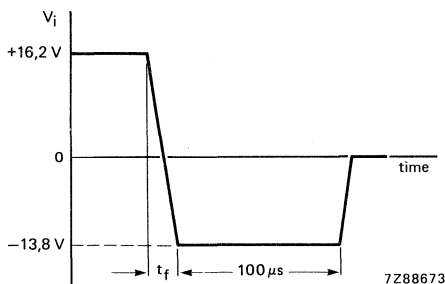

Fig. 3 Input waveform and test circuit for determining storage time and fall time.





## SILICON PLANAR EPITAXIAL TRANSISTOR

N-P-N silicon planar epitaxial transistor in plastic TO-92 envelope intended for switching applications.

### QUICK REFERENCE DATA

Collector-emitter voltage (open base)		$V_{CE0}$	max.	15 V
Collector-base voltage (open emitter)		$V_{CBO}$	max.	40 V
Collector current (d.c.)		$I_C$	max.	600 mA
Total device dissipation up to $T_{amb} = 25\text{ }^\circ\text{C}$		$P_{tot}$	max.	625 mW
Collector-emitter saturation voltage $I_C = 10\text{ mA}; I_B = 1\text{ mA}$	PN2369	$V_{CEsat}$	max.	0,25 V
$I_C = 10\text{ mA}; I_B = 1\text{ mA}$	PN2369A	$V_{CEsat}$	max.	0,20 V
D.C. current gain $I_C = 10\text{ mA}; V_{CE} = 1\text{ V}$	PN2369	$h_{FE}$	min.	40
			max.	120
$I_C = 10\text{ mA}; V_{CE} = 0,35\text{ V}$	PN2369A	$h_{FE}$	min.	40
			max.	120

### MECHANICAL DATA

Dimensions in mm

Fig. 1 TO-92.

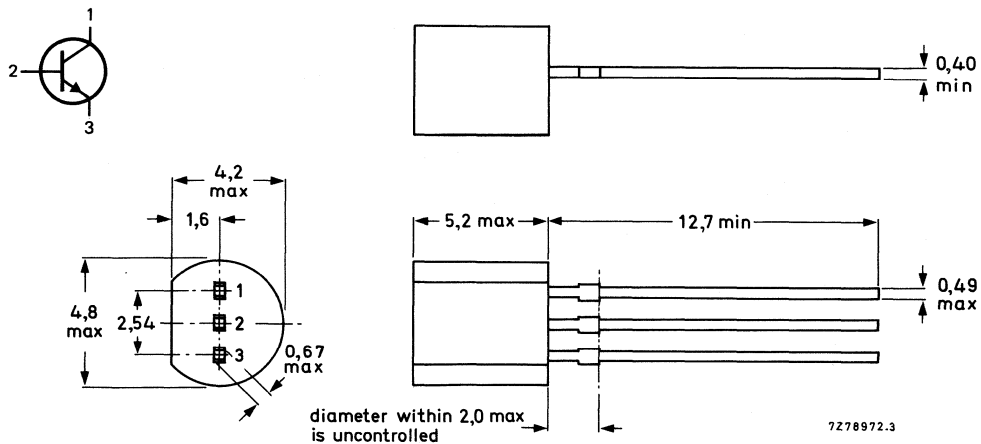

**RATINGS**

Limiting values in accordance with the Absolute Maximum System (IEC 134)

Collector-emitter voltage (open base)	$V_{CEO}$	max.	15 V
Collector-base voltage (open emitter)	$V_{CBO}$	max.	40 V
Emitter-base voltage (open collector)	$V_{EBO}$	max.	4,5 V
Collector current (d.c.)	$I_C$	max.	600 mA
Total device dissipation up to $T_{amb} = 25\text{ }^\circ\text{C}$	$P_{tot}$	max.	625 mW
Storage temperature	$T_{stg}$		-55 to +150 $^\circ\text{C}$
Junction temperature	$T_j$	max.	150 $^\circ\text{C}$

**THERMAL RESISTANCE**

From junction to ambient in free air	$R_{th\ j-a}$	=	200 K/W
--------------------------------------	---------------	---	---------

**CHARACTERISTICS**

$T_j = 25\text{ }^\circ\text{C}$  unless otherwise specified

Collector-emitter breakdown voltage $I_B = 0; I_C = 10\text{ mA}$	$V_{(BR)CEO}$	min.	15 V
Collector-emitter breakdown voltage $I_B = 10\text{ }\mu\text{A}; V_{BE} = 0$	$V_{(BR)CES}$	min.	40 V
Collector-base breakdown voltage $I_E = 0; I_C = 10\text{ }\mu\text{A}$	$V_{(BR)CBO}$	min.	40 V
Emitter-base breakdown voltage $I_E = 10\text{ }\mu\text{A}; I_C = 0$	$V_{(BR)EBO}$	min.	4,5 V
Collector cut-off current $V_{CB} = 20\text{ V}; I_E = 0$ $V_{CB} = 20\text{ V}; I_E = 0; T_A = 125\text{ }^\circ\text{C}$	$I_{CBO}$ $I_{CBO}$	max. max.	0,4 $\mu\text{A}$ 30 $\mu\text{A}$
D.C. current gain $I_C = 10\text{ mA}; V_{CE} = 1\text{ V}$	PN2369	$h_{FE}$	min. 40 max. 120
$I_C = 10\text{ mA}; V_{CE} = 1\text{ V}; T_{amb} = 125\text{ }^\circ\text{C}$		$h_{FE}$	min. 20
$I_C = 100\text{ mA}; V_{CE} = 2\text{ V}$		$h_{FE}$	min. 20
$I_C = 10\text{ mA}; V_{CE} = 0,35\text{ V}$	PN2369A	$h_{FE}$	min. 40 max. 120
$I_C = 30\text{ mA}; V_{CE} = 0,40\text{ V}$		$h_{FE}$	> 30
$I_C = 100\text{ mA}; V_{CE} = 1,0\text{ V}$		$h_{FE}$	> 20
$I_C = 10\text{ mA}; V_{CE} = 0,35\text{ V}; T_{amb} = -55\text{ }^\circ\text{C}$		$h_{FE}$	> 20

## Saturation voltages

 $I_C = 10 \text{ mA}; I_B = 1 \text{ mA}$ 

PN2369

 $V_{CEsat}$  max. 0,25 V $I_C = 10 \text{ mA}; I_B = 1 \text{ mA}$  $V_{BEsat}$  min. 0,70 V

max. 0,85 V

 $I_C = 10 \text{ mA}; I_B = 1 \text{ mA}$ 

PN2369A

 $V_{CEsat}$  < 0,20 V $I_C = 30 \text{ mA}; I_B = 3 \text{ mA}$  $V_{CEsat}$  < 0,25 V $I_C = 100 \text{ mA}; I_B = 10 \text{ mA}$  $V_{CEsat}$  < 0,50 V $I_C = 10 \text{ mA}; I_B = 10 \text{ mA}$  $V_{CEsat}$  < 0,30 V $I_C = 10 \text{ mA}; I_B = 1 \text{ mA}$  $V_{CEsat}$  min. 0,70 V  
max. 0,85 VOutput capacitance at  $f = 1 \text{ MHz}$  $I_E = 0; V_{CB} = 5 \text{ V}$  $C_c$  max. 4 pFSmall-signal current gain at  $f = 100 \text{ MHz}$  $I_C = 10 \text{ mA}; V_{CE} = 10 \text{ V}; T_{amb} = 25 \text{ }^\circ\text{C}$  $h_{fe}$  min. 5

## Switching times

## Storage time (see Fig. 2)

 $I_{Bon} = I_{Boff} = I_C = 10 \text{ mA}; T_{amb} = 25 \text{ }^\circ\text{C}$  $t_s$  typ. 5 ns  
max. 13 ns

## Turn-on time (see Fig. 3)

 $I_C = 10 \text{ mA}; V_{CC} = 3 \text{ V};$  $I_{Bon} = 3 \text{ mA}; T_{amb} = 25 \text{ }^\circ\text{C}$  $t_{on}$  typ. 8 ns  
max. 12 ns

## Turn-off time (see Fig. 3)

 $I_C = 10 \text{ mA}; V_{CC} = 3 \text{ V}; I_{Bon} = 3 \text{ mA};$  $I_{Boff} = 1,5 \text{ mA}; T_{amb} = 25 \text{ }^\circ\text{C}$  $t_{off}$  typ. 10 ns  
max. 18 ns

PN2369  
PN2369A

Pulse generator:

$$\begin{aligned} t_r &< 1 \text{ ns} \\ t_p &> 300 \text{ ns} \\ \delta &< 0,02 \\ R_s &= 50 \Omega \end{aligned}$$

Oscilloscope:

$$\begin{aligned} R_i &= 50 \Omega \\ t_r &< 1 \text{ ns} \end{aligned}$$

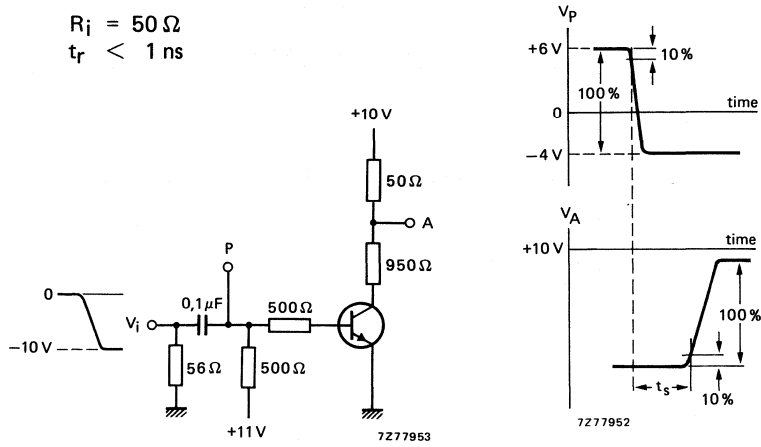

Fig. 2 Test circuit and waveforms.

Pulse generator:

$$\begin{aligned} t_r &< 1 \text{ ns} \\ t_p &> 300 \text{ ns} \\ \delta &< 0,02 \\ R_s &= 50 \Omega \end{aligned}$$

Oscilloscope:

$$\begin{aligned} R_i &= 50 \Omega \\ t_r &< 1 \text{ ns} \end{aligned}$$

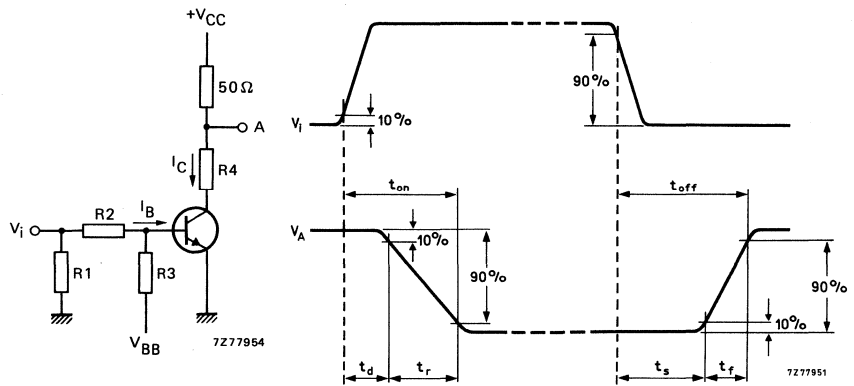

Fig. 3 Test circuit and waveforms.



## SILICON PLANAR EPITAXIAL TRANSISTORS

P-N-P silicon planar epitaxial transistors in plastic TO-92 envelope for general purpose applications.  
N-P-N complement is PN2222/A.

### QUICK REFERENCE DATA

			PN2907	PN2907A
Collector-emitter voltage (open base)	$-V_{CEO}$	max.	40	60 V
Collector-base voltage (open emitter)	$-V_{CBO}$	max.	60	V
Collector current (d.c.)	$-I_C$	max.	600	mA
Total power dissipation up to $T_{amb} = 25^\circ\text{C}$	$P_{tot}$	max.	625	mW
Collector-emitter saturation voltage $-I_C = 150\text{ mA}; -I_B = 15\text{ mA}$	$-V_{CEsat}$	max.	0,4	V
D.C. current gain $-I_C = 150\text{ mA}; -V_{CE} = 10\text{ V}$	$h_{FE}$	min. max.	100 300	

### MECHANICAL DATA

Dimensions in mm

Fig. 1 TO-92.

#### Pinning

- 1 = collector
- 2 = base
- 3 = emitter

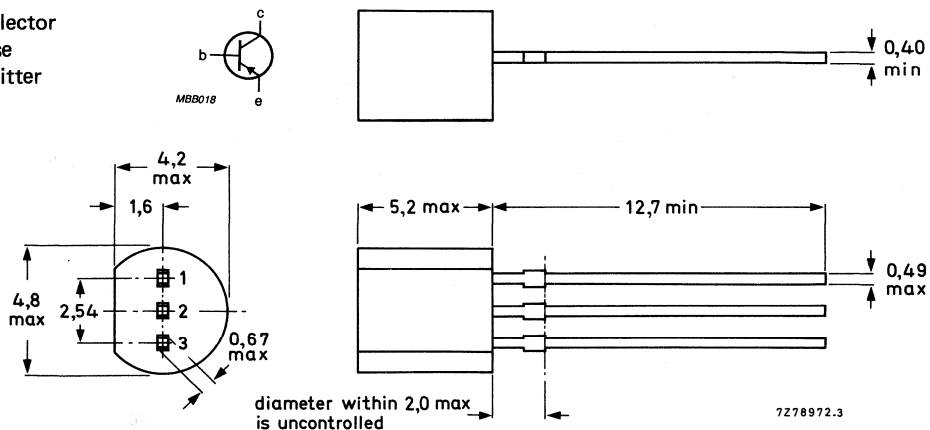

**RATINGS**

Limiting values in accordance with the Absolute Maximum System (IEC 134)

			PN2907	PN2907A
Collector-emitter voltage (open base)	$-V_{CEO}$	max.	40	60 V
Collector-base voltage (open emitter)	$-V_{CBO}$	max.	60	V
Emitter-base voltage (open collector)	$-V_{EBO}$	max.	5,0	V
Collector current (d.c.)	$-I_C$	max.	600	mA
Total power dissipation up to $T_{amb} = 25\text{ }^{\circ}\text{C}$	$P_{tot}$	max.	625	mW
Storage temperature range	$T_{stg}$		-65 to +150	$^{\circ}\text{C}$
Junction temperature	$T_j$	max.	150	$^{\circ}\text{C}$

**THERMAL RESISTANCE**

From junction to ambient in free air	$R_{th\ j-a}$	=	200	K/W
--------------------------------------	---------------	---	-----	-----

**CHARACTERISTICS**

$T_j = 25\text{ }^{\circ}\text{C}$  unless otherwise specified

Collector-emitter breakdown voltage $I_B = 0; -I_C = 10\text{ mA}$	$-V_{(BR)CEO}$	min.	40	60 V
Collector-base breakdown voltage $I_E = 0; -I_C = 10\text{ }\mu\text{A}$	$-V_{(BR)CBO}$	min.	60	V
Emitter-base breakdown voltage $-I_E = 10\text{ }\mu\text{A}; I_C = 0$	$-V_{(BR)EBO}$	min.	5,0	V
Base cut-off current $-V_{CE} = 30\text{ V}; -V_{BE} = 0,5\text{ V}$	$-I_{BEX}$	max.	50	nA
Collector cut-off current $-V_{CE} = 30\text{ V}; -V_{BE} = 0,5\text{ V}$	$-I_{CEX}$	max.	50	nA
Collector cut-off current $I_E = 0; V_{CB} = 50\text{ V}$	$-I_{CBO}$	max.	20	10 nA
$I_E = 0; V_{CB} = 50\text{ V}; T_{amb} = 125\text{ }^{\circ}\text{C}$	$-I_{CBO}$	max.	20	10 $\mu\text{A}$
D.C. current gain $-I_C = 0,1\text{ mA}; -V_{CE} = 10\text{ V}$	$h_{FE}$	min.	35	75
$-I_C = 1,0\text{ mA}; -V_{CE} = 10\text{ V}$	$h_{FE}$	min.	50	100
$-I_C = 10\text{ mA}; -V_{CE} = 10\text{ V}$	$h_{FE}$	min.	75	100
$-I_C = 150\text{ mA}; -V_{CE} = 10\text{ V}$	$h_{FE}$	min.	100	100
$-I_C = 500\text{ mA}; -V_{CE} = 10\text{ V}$	$h_{FE}$	max.	300	300
	$h_{FE}$	min.	30	50

			PN2907	PN2907A
<b>Saturation voltages</b>				
$-I_C = 150 \text{ mA}; -I_B = 15 \text{ mA}$	$-V_{CEsat}$	max.	0,4	V
$-I_C = 500 \text{ mA}; -I_B = 50 \text{ mA}$	$-V_{CEsat}$	max.	1,6	V
$-I_C = 150 \text{ mA}; -I_B = 15 \text{ mA}$	$-V_{BEsat}$	max.	1,3	V
$-I_C = 150 \text{ mA}; -I_B = 50 \text{ mA}$	$-V_{BEsat}$	max.	2,6	V
<b>Transition frequency at <math>f = 100 \text{ MHz}</math></b>				
$-I_C = 50 \text{ mA}; -V_{CE} = 20 \text{ V}; T_{amb} = 25 \text{ }^\circ\text{C}$	$f_T$	min.	200	MHz
<b>Output capacitance at <math>f = 1 \text{ MHz}</math></b>				
$I_E = 0; -V_{CB} = 10 \text{ V}; T_{amb} = 25 \text{ }^\circ\text{C}$	$C_C$	max.	8,0	pF
<b>Input capacitance at <math>f = 1 \text{ MHz}</math></b>				
$I_C = 0; -V_{EB} = 2,0 \text{ V}; T_{amb} = 25 \text{ }^\circ\text{C}$	$C_e$	max.	30	pF
<b>Switching times</b>				
<b>Turn-on time (see Fig. 2)</b>				
$-I_C = 150 \text{ mA}; -I_{Bon} = 15 \text{ mA}; -V_{CC} = 30 \text{ V}$	$t_{on}$	max.	45	ns
delay time	$t_d$	max.	10	ns
rise time	$t_r$	max.	40	ns
<b>Turn-off time (see Fig. 3)</b>				
$-I_C = 150 \text{ mA}; -I_{Bon} = I_{Boff} = 15 \text{ mA}; -V_{CC} = 6,0 \text{ V}$	$t_{off}$	max.	100	ns
storage time	$t_s$	max.	80	ns
fall time	$t_f$	max.	30	ns

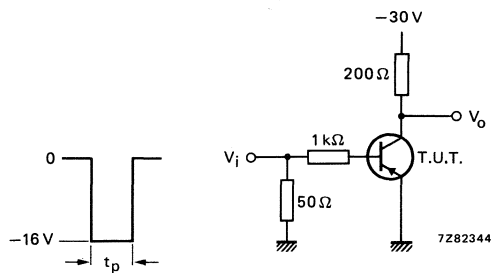

Fig. 2 Input waveform and test circuit for determining delay, rise and turn-on time.

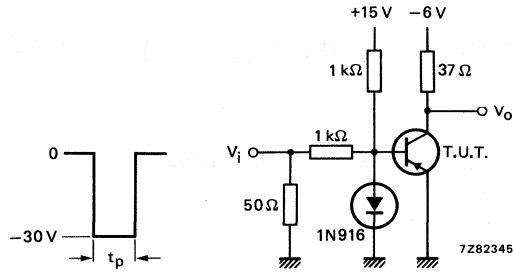

Fig. 3 Input waveform and test circuit for determining storage, fall and turn-off time.

Pulse generator (see Figs 2 and 3)

frequency	$f$	$=$	150 Hz
pulse duration	$t_p$	$=$	200 ns
rise time	$t_r$	$\leq$	2 ns
output impedance	$Z_o$	$=$	50 $\Omega$

Oscilloscope (see Figs 2 and 3)

rise time	$t_r$	$\leq$	5 ns
input impedance	$Z_i$	$\leq$	10 M $\Omega$





## SILICON N-P-N HIGH-VOLTAGE TRANSISTORS

N-P-N high-voltage small-signal transistors in a TO-92 envelope and intended for use in telephony and professional communication equipment.

Complementary type is PN5415/5416.

### QUICK REFERENCE DATA

			PN3439	PN3440
Collector-base voltage (open emitter)	$V_{CB0}$	max.	400	300 V
Collector-emitter voltage (open base)	$V_{CEO}$	max.	350	250 V
Collector current (d.c.)	$I_C$	max.	1,0	1,0 A
Total power dissipation up to $T_{amb} = 25\text{ }^\circ\text{C}$	$P_{tot}$	max.	625	625 mW
Junction temperature	$T_j$	max.	150	150 $^\circ\text{C}$
Collector-emitter saturation voltage $I_C = 50\text{ mA}; I_B = 4\text{ mA}$	$V_{CEsat}$	<	0,5	0,5 V
D.C. current gain $I_C = 2\text{ mA}; V_{CE} = 10\text{ V}$ $I_C = 20\text{ mA}; V_{CE} = 10\text{ V}$	$h_{FE}$	>	30	40

### MECHANICAL DATA

Dimensions in mm

Fig. 1 TO-92.

#### Pinning

- 1 = collector
- 2 = base
- 3 = emitter

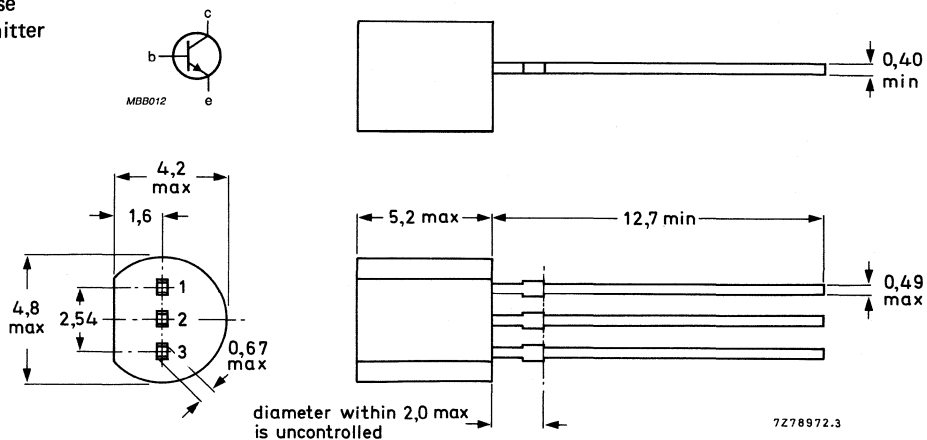

**RATINGS**

Limiting values in accordance with the Absolute Maximum System (IEC 134)

			PN3439	PN3440
Collector-base voltage (open emitter)	$V_{CBO}$	max.	400	300 V
Collector-emitter voltage (open base)	$V_{CEO}$	max.	350	250 V
Emitter-base voltage (open collector)	$V_{EBO}$	max.	5,0	V
Collector current (d.c.)	$I_C$	max.	1,0	A
Base current	$I_B$	max.	0,5	A
Total power dissipation up to $T_{amb} = 25\text{ }^\circ\text{C}$	$P_{tot}$	max.	625	mW
Junction temperature	$T_j$	max.	150	$^\circ\text{C}$
Storage temperature range	$T_{stg}$		-65 to 150	$^\circ\text{C}$

**THERMAL RESISTANCE**

From junction to ambient in free air	$R_{th\ j-a}$	=	200	K/W
--------------------------------------	---------------	---	-----	-----

**CHARACTERISTICS**

$T_j = 25\text{ }^\circ\text{C}$  unless otherwise specified

			PN3439	PN3440
Collector cut-off currents				
$I_E = 0; V_{CB} = 360\text{ V}$	$I_{CBO}$	<	0,1	$\mu\text{A}$
$I_E = 0; V_{CB} = 250\text{ V}$	$I_{CBO}$	<		0,1 $\mu\text{A}$
$I_B = 0; V_{CE} = 300\text{ V}$	$I_{CEO}$	<	1,0	$\mu\text{A}$
$I_B = 0; V_{CE} = 200\text{ V}$	$I_{CEO}$	<		1,0 $\mu\text{A}$
Emitter cut-off current				
$I_C = 0; V_{EB} = 5\text{ V}$	$I_{EBO}$	<	10	10 $\mu\text{A}$
Collector-emitter sustaining voltage				
$I_B = 0; I_C = 50\text{ mA}$	$V_{CEO_{sus}}$	>	350	250 V
Saturation voltages				
$I_C = 50\text{ mA}; I_B = 4\text{ mA}$	$V_{CE_{sat}}$	<	0,5	0,5 V
	$V_{BE_{sat}}$	<	1,3	1,3 V
D.C. current gain				
$I_C = 2\text{ mA}; V_{CE} = 10\text{ V}$	$h_{FE}$	>	30	
$I_C = 20\text{ mA}; V_{CE} = 10\text{ V}$	$h_{FE}$	>		40
Transition frequency at $f = 5\text{ MHz}$				
$I_C = 10\text{ mA}; V_{CE} = 10\text{ V}; T_{amb} = 25\text{ }^\circ\text{C}$	$f_T$	>	70	MHz
Small-signal current gain at $f = 1\text{ kHz}$				
$I_C = 5\text{ mA}; V_{CE} = 10\text{ V}; T_{amb} = 25\text{ }^\circ\text{C}$	$h_{fe}$	>	25	
Real part (Re) of input impedance ( $h_{ie}$ )				
$V_{CE} = 10\text{ V}; I_C = 5\text{ mA}; f = 1\text{ MHz}; T_{amb} = 25\text{ }^\circ\text{C}$	$Re(h_{ie})$	<	300	$\Omega$
Input capacitance at $f = 1\text{ MHz}$				
$I_C = 0; V_{EB} = 5\text{ V}; T_{amb} = 25\text{ }^\circ\text{C}$	$C_e$	<	20	pF
Output capacitance at $f = 1\text{ MHz}$				
$I_E = 0; V_{CB} = 10\text{ V}; T_{amb} = 25\text{ }^\circ\text{C}$	$C_c$	<	2,0	pF



## SILICON P-N-P HIGH-VOLTAGE TRANSISTORS

P-N-P high-voltage small-signal transistors in a TO-92 envelope and intended for use in telephony and professional communication equipment.

Complementary type is PN3439/3440.

### QUICK REFERENCE DATA

			PN5415	PN5416
Collector-base voltage (open emitter)	$-V_{CB0}$	max.	200	350 V
Collector-emitter voltage (open base)	$-V_{CEO}$	max.	200	300 V
Collector current (d.c.)	$-I_C$	max.	1,0	1,0 A
Total power dissipation up to $T_{amb} = 25\text{ }^{\circ}\text{C}$	$P_{tot}$	max.	625	625 mW
Junction temperature	$T_j$	max.	150	150 $^{\circ}\text{C}$
Collector-emitter saturation voltage $-I_C = 50\text{ mA}; -I_B = 5\text{ mA}$	$-V_{CEsat}$	<	0,8	0,8 V
D.C. current gain $-I_C = 50\text{ mA}; -V_{CE} = 10\text{ V}$	$h_{FE}$	>	30	30
		<	150	120

### MECHANICAL DATA

Dimensions in mm

Fig. 1 TO-92.

#### Pinning

- 1 = collector
- 2 = base
- 3 = emitter

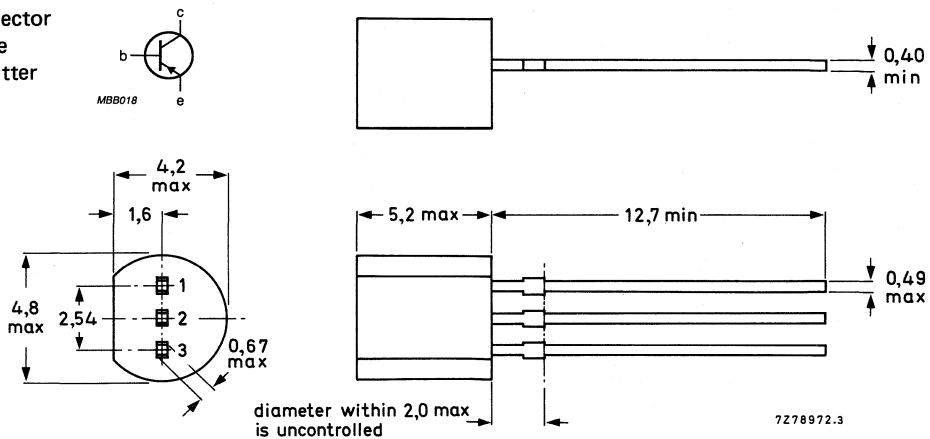

### RATINGS

Limiting values in accordance with the Absolute Maximum System (IEC 134)

			PN5415	PN5416
Collector-base voltage (open emitter)	$-V_{CBO}$	max.	200	350 V
Collector-emitter voltage (open base)	$-V_{CEO}$	max.	200	300 V
Emitter-base voltage (open collector)	$-V_{EBO}$	max.	4,0	6,0 V
Collector current (d.c.)	$-I_C$	max.	1,0	A
Base current	$-I_B$	max.	0,5	A
Total power dissipation up to $T_{amb} = 25\text{ }^\circ\text{C}$	$P_{tot}$	max.	625	mW
Junction temperature	$T_j$	max.	150	$^\circ\text{C}$
Storage temperature range	$T_{stg}$		-65 to 150	$^\circ\text{C}$

### THERMAL RESISTANCE

From junction to ambient in free air	$R_{th\ j-a}$	=	200	K/W
--------------------------------------	---------------	---	-----	-----

### CHARACTERISTICS

$T_j = 25\text{ }^\circ\text{C}$  unless otherwise specified

			PN5415	PN5416
Collector cut-off currents				
$I_E = 0; -V_{CB} = 175\text{ V}$	$-I_{CBO}$	<	0,1	$\mu\text{A}$
$I_E = 0; -V_{CB} = 280\text{ V}$	$-I_{CBO}$	<		0,1 $\mu\text{A}$
$I_B = 0; -V_{CE} = 150\text{ V}$	$-I_{CEO}$	<	1,0	$\mu\text{A}$
$I_B = 0; -V_{CE} = 250\text{ V}$	$-I_{CEO}$	<		1,0 $\mu\text{A}$
Emitter cut-off current				
$I_C = 0; -V_{EB} = 4\text{ V}$	$-I_{EBO}$	<	1,0	$\mu\text{A}$
$I_C = 0; -V_{EB} = 6\text{ V}$	$-I_{EBO}$	<		1,0 $\mu\text{A}$
Collector-emitter sustaining voltage				
$I_B = 0; -I_C = 50\text{ mA}$	$-V_{CEO_{sus}}$	>	200	300 V
Saturation voltages				
$-I_C = 50\text{ mA}; -I_B = 5\text{ mA}$	$-V_{CE_{sat}}$	<	0,8	0,8 V
	$-V_{BE_{sat}}$	<	1,0	1,0 V
D.C. current gain				
$-I_C = 50\text{ mA}; -V_{CE} = 10\text{ V}$	$h_{FE}$	>	30	30
	$h_{FE}$	<	150	120
Transition frequency at $f = 5\text{ MHz}$				
$-I_C = 10\text{ mA}; -V_{CE} = 10\text{ V}; T_{amb} = 25\text{ }^\circ\text{C}$	$f_T$	>		15 MHz
Small-signal current gain at $f = 5\text{ MHz}$				
$-I_C = 10\text{ mA}; -V_{CE} = 10\text{ V}; T_{amb} = 25\text{ }^\circ\text{C}$	$h_{fe}$	>		25
Real part (Re) of input impedance ( $h_{ie}$ )				
$-V_{CE} = 10\text{ V}; -I_C = 5\text{ mA}; f = 1\text{ MHz}; T_{amb} = 25\text{ }^\circ\text{C}$	$Re(h_{ie})$	<	300	$\Omega$
Input capacitance at $f = 1\text{ MHz}$				
$I_C = 0; -V_{EB} = 5\text{ V}; T_{amb} = 25\text{ }^\circ\text{C}$	$C_e$	<	75	pF
Output capacitance at $f = 1\text{ MHz}$				
$I_E = 0; -V_{CB} = 10\text{ V}; T_{amb} = 25\text{ }^\circ\text{C}$	$C_c$	<	15	pF

## N-P-N SILICON PLANAR TRANSISTOR

N-P-N transistors in TO-18 metal envelopes with the collector connected to the case.

These devices are primarily intended for use in high performance, low-level, low-noise amplifier applications both for direct current and for frequencies of up to 100 MHz.

### QUICK REFERENCE DATA

Collector-base voltage (open emitter)	$V_{CBO}$	max.	45 V
Collector-emitter voltage (open base)	$V_{CEO}$	max.	45 V
Collector current (peak value)	$I_{CM}$	max.	60 mA
Total power dissipation up to $T_{amb} = 25\text{ }^{\circ}\text{C}$	$P_{tot}$	max.	300 mW
Junction temperature	$T_j$	max.	175 $^{\circ}\text{C}$
D.C. current gain at $T_j = 25\text{ }^{\circ}\text{C}$ $I_C = 10\text{ }\mu\text{A}; V_{CE} = 5\text{ V}$	$h_{FE}$	>	100
		<	300
$I_C = 10\text{ mA}; V_{CE} = 5\text{ V}$	$h_{FE}$	>	150
		<	600
Transition frequency $I_C = 0,5\text{ mA}; V_{CE} = 5\text{ V}$	$f_T$	typ.	80 MHz
Noise figure at $R_S = 10\text{ k}\Omega$ $I_C = 10\text{ }\mu\text{A}; V_{CE} = 5\text{ V}$ $f = 10\text{ Hz to } 15\text{ kHz}$	F	typ.	2 dB
		<	3 dB

### MECHANICAL DATA

Dimensions in mm

Fig. 1 TO-18.

Collector connected to case.

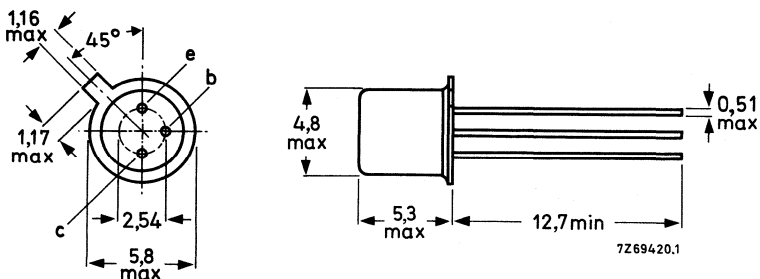

**RATINGS**

Limiting values in accordance with the Absolute Maximum System (IEC 134)

Collector-base voltage (open emitter)	$V_{CBO}$	max.	45 V
Collector-emitter voltage (open base)	$V_{CEO}$	max.	45 V
Collector-emitter voltage at $V_{EB} = 0$	$V_{CES}$	max.	45 V
Emitter-base voltage (open collector)	$V_{EBO}$	max.	5 V
Collector current (d.c. or average over any 50 ms period)	$I_C$	max.	30 mA
Collector current (peak value)	$I_{CM}$	max.	60 mA
Emitter current (d.c. or average over any 50 ms period)	$-I_E$	max.	35 mA
Emitter current (peak value)	$-I_{EM}$	max.	70 mA
Total power dissipation up to $T_{amb} = 25\text{ }^\circ\text{C}$	$P_{tot}$	max.	300 mW
Storage temperature range	$T_{stg}$		$-65$ to $+150\text{ }^\circ\text{C}$
Junction temperature	$T_j$	max.	$175\text{ }^\circ\text{C}$

**THERMAL RESISTANCE**

From junction to ambient in free air	$R_{th\ j-a}$	=	0,5 K/mW
From junction to case	$R_{th\ j-c}$	=	0,25 K/mW

**CHARACTERISTICS**

$T_j = 25\text{ }^\circ\text{C}$  unless otherwise specified

Collector cut-off current

$$I_E = 0; V_{CB} = 45\text{ V}$$

$$I_{CBO} < 10\text{ nA}$$

$$I_B = 0; V_{CE} = 5\text{ V}$$

$$I_{CEO} < 2\text{ nA}$$

$$V_{EB} = 0; V_{CB} = 45\text{ V}$$

$$I_{CES} < 10\text{ nA}$$

Emitter cut-off current

$$I_C = 0; V_{EB} = 5\text{ V}$$

$$I_{EBO} < 10\text{ nA}$$

Emitter-base voltage

$$-I_E = 0,5\text{ mA}; V_{CB} = 5\text{ V}$$

$$-V_{EB} \quad 0,6\text{ to }0,8\text{ V}$$

Saturation voltages

$$I_C = 10\text{ mA}; I_B = 0,5\text{ mA}$$

$$V_{CEsat} < 1\text{ V}$$

$$V_{BEsat} \quad 0,6\text{ to }1\text{ V}$$

D.C. current gain

$$I_C = 10\text{ }\mu\text{A}; V_{CE} = 5\text{ V}$$

$$h_{FE} \quad 100\text{ to }300$$

$$I_C = 10\text{ }\mu\text{A}; V_{CE} = 5\text{ V}; T_j = -55\text{ }^\circ\text{C}$$

$$h_{FE} > 20$$

$$I_C = 500\text{ }\mu\text{A}; V_{CE} = 5\text{ V}$$

$$h_{FE} > 150$$

$$I_C = 10\text{ mA}; V_{CE} = 5\text{ V}$$

$$h_{FE} \quad 150\text{ to }600$$

Collector capacitance at  $f = 1\text{ MHz}$

$$I_E = I_e = 0; V_{CB} = 5\text{ V}$$

$$C_c < 8\text{ pF}$$

Transition frequency

$$I_C = 0,5\text{ mA}; V_{CE} = 5\text{ V}$$

$$f_T > 50\text{ MHz}$$

Cut-off frequency

$$I_C = 0,5\text{ mA}; V_{CE} = 5\text{ V}$$

$$f_{hfe} > 100\text{ kHz}$$

Noise figure ( $f = 10\text{ Hz to }15\text{ kHz}$ )

$$I_C = 10\text{ }\mu\text{A}; V_{CE} = 5\text{ V}; R_S = 10\text{ k}\Omega$$

$$F \quad \text{typ. } 2\text{ dB}$$

$$< 3\text{ dB}$$

h parameters at  $f = 1\text{ kHz}$

$$I_C = 1\text{ mA}; V_{CE} = 5\text{ V}$$

Input impedance

$$h_{ie} \quad \text{typ. } 10,0\text{ k}\Omega$$

Reverse voltage transfer

$$h_{re} \quad \text{typ. } 5,5 \cdot 10^{-4}$$

Small signal current gain

$$h_{fe} \quad \text{typ. } 350$$

$$150\text{ to }600$$

Output admittance

$$h_{oe} \quad \text{typ. } 25\text{ }\mu\text{S}$$





## SILICON PLANAR TRANSISTOR



N-P-N double diffused transistor in a TO-39 metal envelope designed for a wide variety of applications including d.c. amplifiers, high-speed switching and high-speed amplifiers.

## QUICK REFERENCE DATA

Collector-base voltage (open emitter)	$V_{CBO}$	max.	75 V
Collector-emitter voltage ( $R_{BE} \leq 10 \Omega$ )	$V_{CER}$	max.	50 V
Collector current (peak value)	$I_{CM}$	max.	500 mA
Total power dissipation up to $T_{amb} = 25^\circ C$	$P_{tot}$	max.	0,8 W
D.C. current gain at $T_j = 25^\circ C$ $I_C = 150 \text{ mA}; V_{CE} = 10 \text{ V}$	$h_{FE}$		40 to 120
Transition frequency at $f = 20 \text{ MHz}$ $I_C = 50 \text{ mA}; V_{CE} = 10 \text{ V}$	$f_T$	>	60 MHz

## MECHANICAL DATA

Dimensions in mm

Fig. 1 TO-39.

Collector connected to case

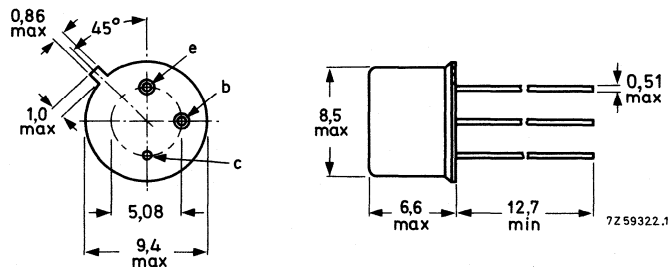

Maximum lead diameter is guaranteed only for 12,7 mm.

## RATINGS

Limiting values in accordance with the Absolute Maximum System (IEC 134)

Collector-base voltage (open emitter)	$V_{CB0}$	max.	75 V
Collector-emitter voltage ( $R_{BE} \leq 10 \Omega$ )	$V_{CER}$	max.	50 V
Emitter-base voltage (open collector)	$V_{EBO}$	max.	7 V
Collector current (peak value) *	$I_{CM}$	max.	500 mA
Total power dissipation up to $T_{amb} = 25 \text{ }^\circ\text{C}$	$P_{tot}$	max.	0,8 W
at $T_{case} = 100 \text{ }^\circ\text{C}$	$P_{tot}$	max.	1,7 W
up to $T_{case} = 25 \text{ }^\circ\text{C}$	$P_{tot}$	max.	3,0 W
Storage temperature range	$T_{stg}$		$-65$ to $+150 \text{ }^\circ\text{C}$
Junction temperature	$T_j$	max.	$200 \text{ }^\circ\text{C}$
Lead soldering temperature > 1,5 mm from the seating plane; $t_{sld} < 10 \text{ s}$ .	$T_{sld}$	max.	$300 \text{ }^\circ\text{C}$

## THERMAL RESISTANCE

From junction to case  $R_{th\ j-c} = 58,3 \text{ K/W}$ 

\* With the exception of the collector current all other data are Jedec registered.

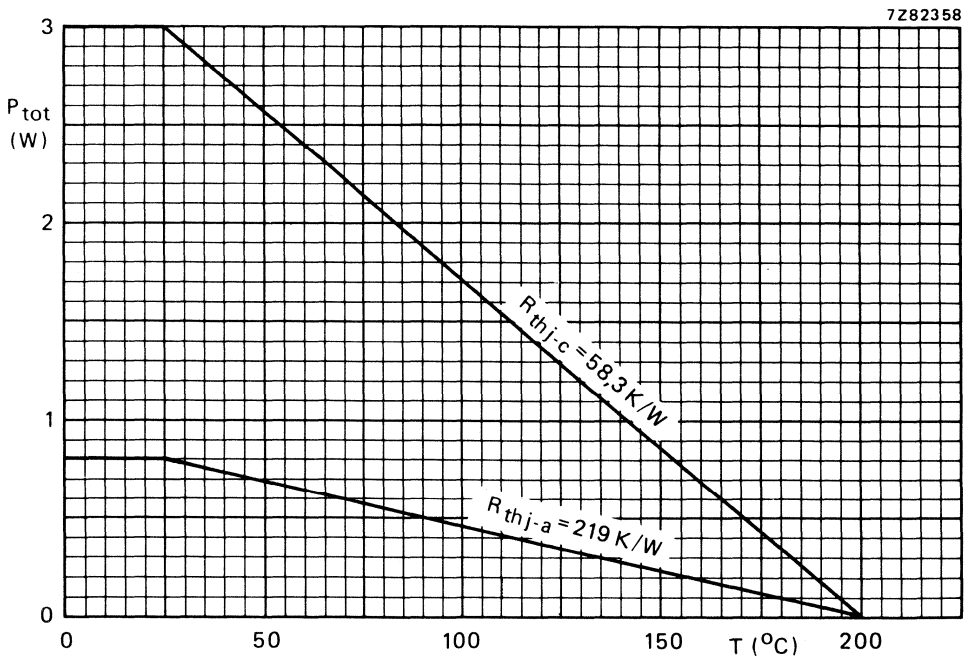

Fig. 2 Maximum permissible total power dissipation as a function of temperature.

## CHARACTERISTICS

$T_{amb} = 25\text{ }^{\circ}\text{C}$  unless otherwise specified

Collector cut-off current

$$I_E = 0; V_{CB} = 60\text{ V}$$

$$I_{CBO} < 10\text{ nA}$$

$$I_E = 0; V_{CB} = 60\text{ V}; T_{amb} = 150\text{ }^{\circ}\text{C}$$

$$I_{CBO} < 10\text{ }\mu\text{A}$$

Emitter cut-off current

$$I_C = 0; V_{EB} = 5\text{ V}$$

$$I_{EBO} < 10\text{ nA}$$

Collector-base breakdown voltage

$$\text{open emitter}; I_C = 100\text{ }\mu\text{A}$$

$$V_{(BR)CBO} > 75\text{ V}$$

Collector-emitter breakdown voltage\*

$$I_C = 100\text{ mA}; R_{BE} \leq 10\text{ }\Omega$$

$$V_{(BR)CER} > 50\text{ V}$$

Emitter-base breakdown voltage

$$\text{open collector}; I_E = 100\text{ }\mu\text{A}$$

$$V_{(BR)EBO} > 7\text{ V}$$

Saturation voltages\*

$$I_C = 150\text{ mA}; I_B = 15\text{ mA}$$

$$V_{CEsat} < 1,5\text{ V}$$

$$V_{BEsat} < 1,3\text{ V}$$

D.C. current gain

$$I_C = 0,1\text{ mA}; V_{CE} = 10\text{ V}$$

$$h_{FE} > 20$$

$$I_C = 10\text{ mA}; V_{CE} = 10\text{ V}^*$$

$$h_{FE} > 35$$

$$I_C = 10\text{ mA}; V_{CE} = 10\text{ V}; T_{amb} = -55\text{ }^{\circ}\text{C}$$

$$h_{FE} > 20$$

$$I_C = 150\text{ mA}; V_{CE} = 10\text{ V}^*$$

$$h_{FE} \quad 40\text{ to }120$$

$$I_C = 500\text{ mA}; V_{CE} = 10\text{ V}^*$$

$$h_{FE} > 20$$

Transition frequency at  $f = 20\text{ MHz}$

$$I_C = 50\text{ mA}; V_{CE} = 10\text{ V}$$

$$f_T > 60\text{ MHz}$$

Collector capacitance

$$I_E = I_e = 0; V_{CB} = 10\text{ V}$$

$$C_c < 25\text{ pF}$$

Emitter capacitance

$$I_C = I_c = 0; V_{EB} = 0,5\text{ V}$$

$$C_e < 80\text{ pF}$$

Noise figure at  $f = 1\text{ kHz}$

$$I_C = 0,3\text{ mA}; V_{CE} = 10\text{ V}; R_S = 510\text{ }\Omega; B = 1\text{ Hz}$$

$$F < 12\text{ dB}$$

**h-parameters** at  $f = 1\text{ kHz}$

Input impedance

$$I_C = 1\text{ mA}; V_{CB} = 5\text{ V}$$

$$h_{ib} \quad 24\text{ to }34\text{ }\Omega$$

$$I_C = 5\text{ mA}; V_{CB} = 10\text{ V}$$

$$h_{ib} \quad 4\text{ to }8\text{ }\Omega$$

Reverse voltage transfer ratio

$$I_C = 1\text{ mA}; V_{CE} = 5\text{ V}$$

$$h_{rb} < 3 \cdot 10^{-4}$$

$$I_C = 5\text{ mA}; V_{CE} = 10\text{ V}$$

$$h_{rb} < 3 \cdot 10^{-4}$$

Small-signal current gain

$$I_C = 1\text{ mA}; V_{CE} = 5\text{ V}$$

$$h_{fe} \quad 30\text{ to }100$$

$$I_C = 5\text{ mA}; V_{CE} = 10\text{ V}$$

$$h_{fe} \quad 35\text{ to }150$$

\* Measured under pulse conditions to avoid excessive dissipation:  $t_p = 300\text{ }\mu\text{s}$ ;  $\delta \leq 0,02$ .

Output admittance

$I_C = 1 \text{ mA}; V_{CE} = 5 \text{ V}$

$I_C = 5 \text{ mA}; V_{CE} = 10 \text{ V}$

Total switching time (see Figs 3 to 6)

$I_{Con} = 50 \text{ mA}; V_{BEon} = -V_{BEoff} = 1 \text{ V}$

$h_{ob} \quad 0,05 \text{ to } 0,5 \mu\text{S}$

$h_{ob} \quad 0,05 \text{ to } 0,5 \mu\text{S}$

$t_{on} + t_{off} < \quad 30 \text{ ns}$

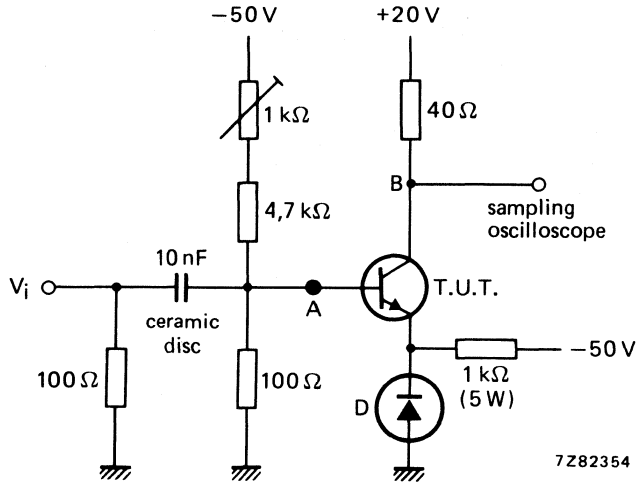

Fig. 3 Turn-on plus turn-off measuring circuit. D = BAW62.

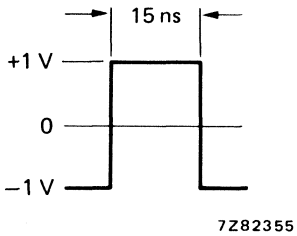

Fig. 4 Waveform at "A".  
Pulse generator:  $t_r; t_f < 1 \text{ ns}$ .

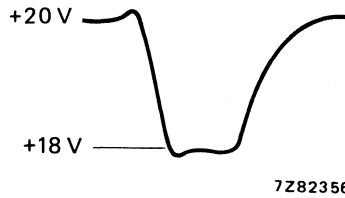

Fig. 5 Waveform at "B".

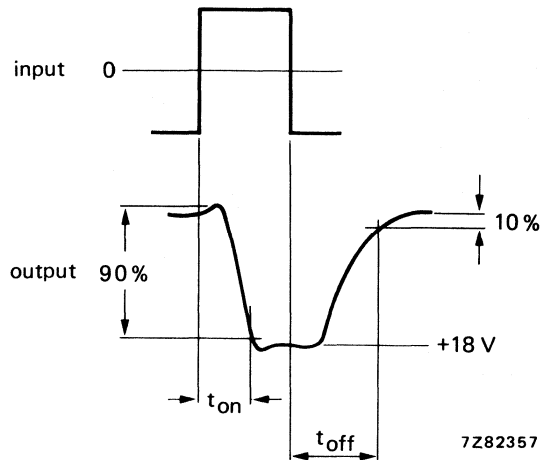

Fig. 6 Turn-on and turn-off time.

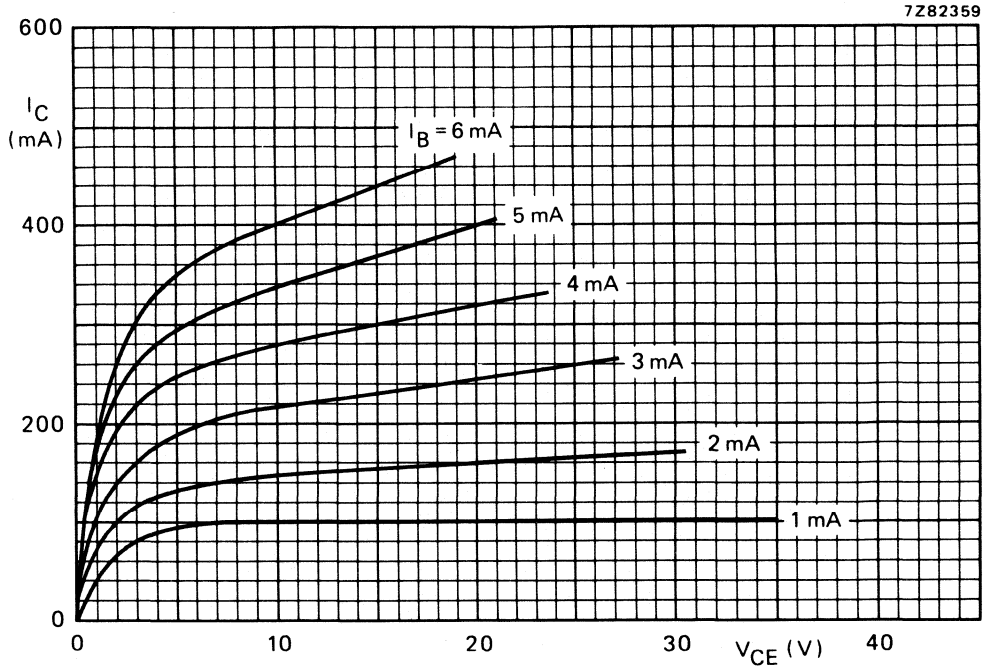

Fig. 7  $T_j = 25^\circ\text{C}$ ; typical values.

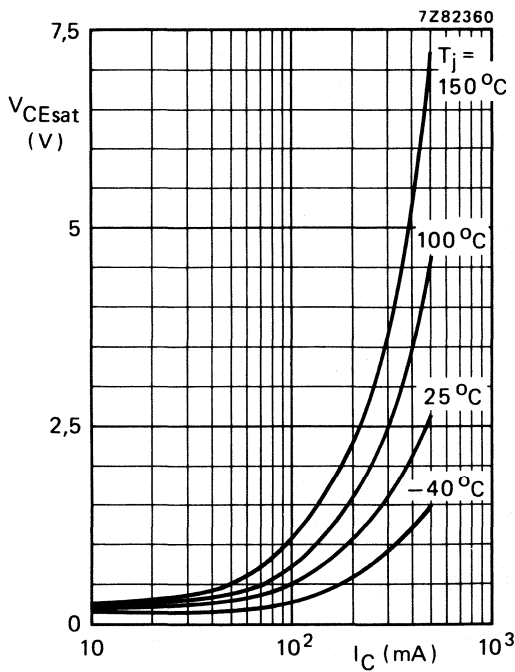

Fig. 8  $I_C/I_B = 10$ ; typical values.

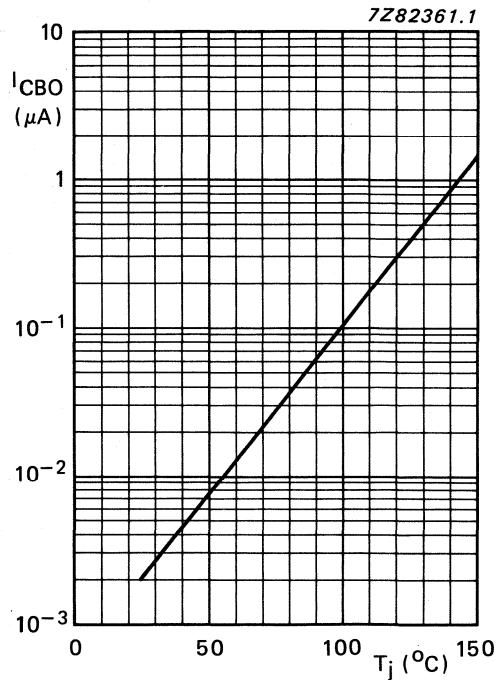

Fig. 9  $V_{CB} = 60\text{ V}$ ; typical values.

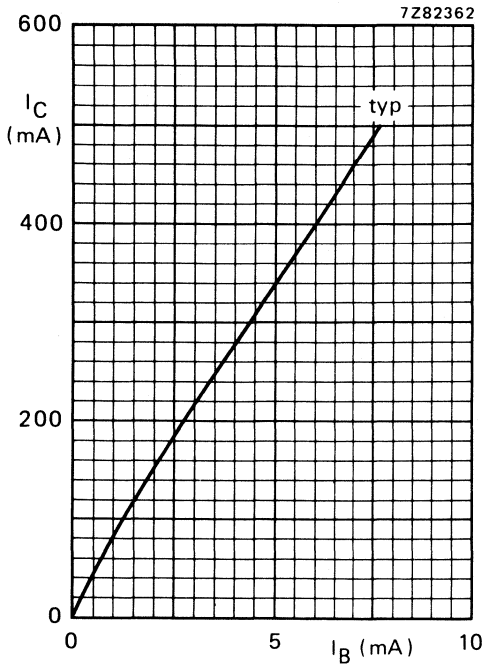

Fig. 10  $V_{CE} = 10\text{ V}$ ;  $T_j = 25\text{ }^\circ\text{C}$ .

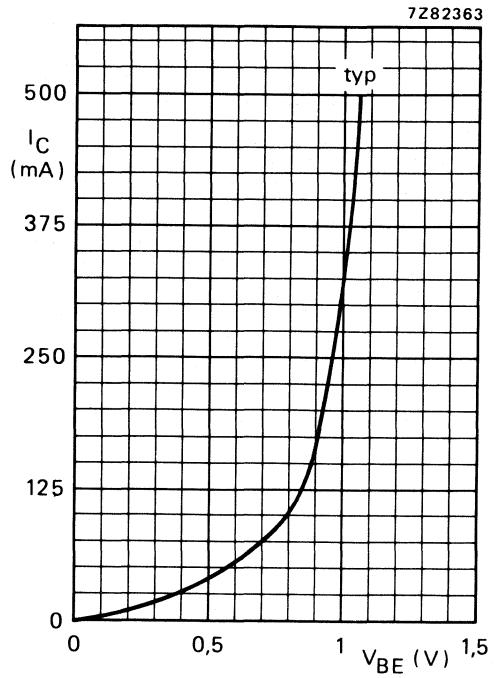

Fig. 11  $V_{CE} = 10\text{ V}$ ;  $T_j = 25\text{ }^\circ\text{C}$ .

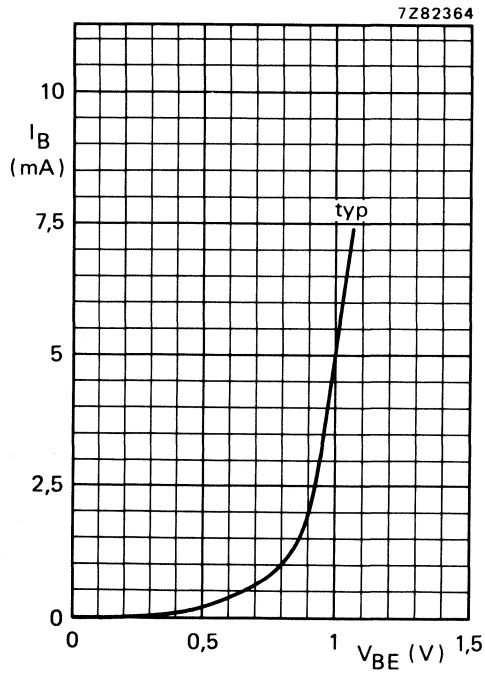

Fig. 12  $V_{CE} = 10\text{ V}$ ;  $T_j = 25\text{ }^\circ\text{C}$ .

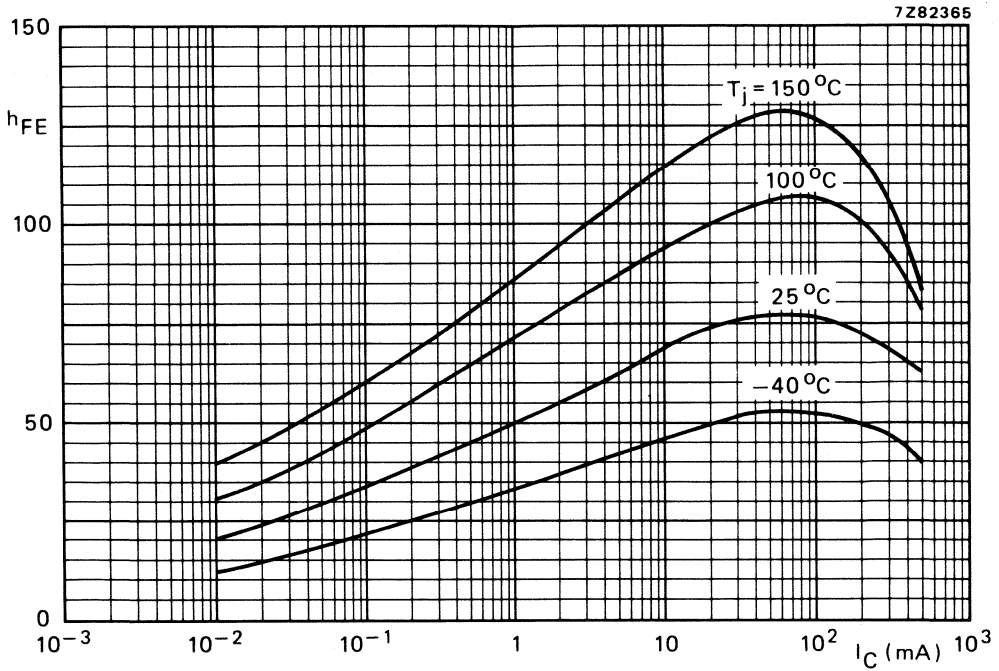

Fig. 13  $V_{CE} = 10\text{ V}$ ; typical values.

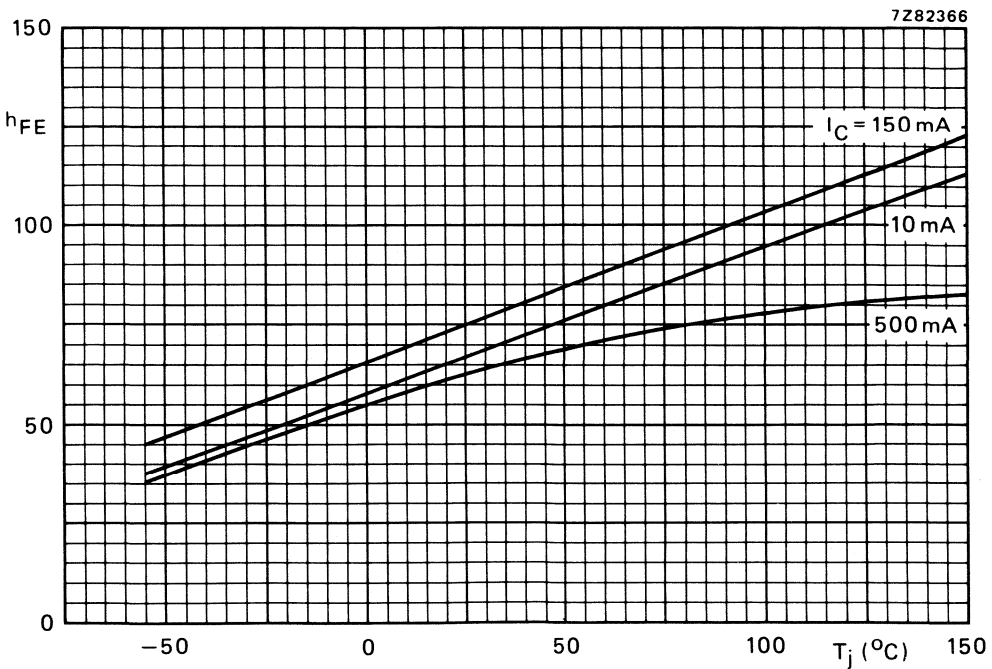

Fig. 14  $V_{CE} = 10\text{ V}$ ; typical values.

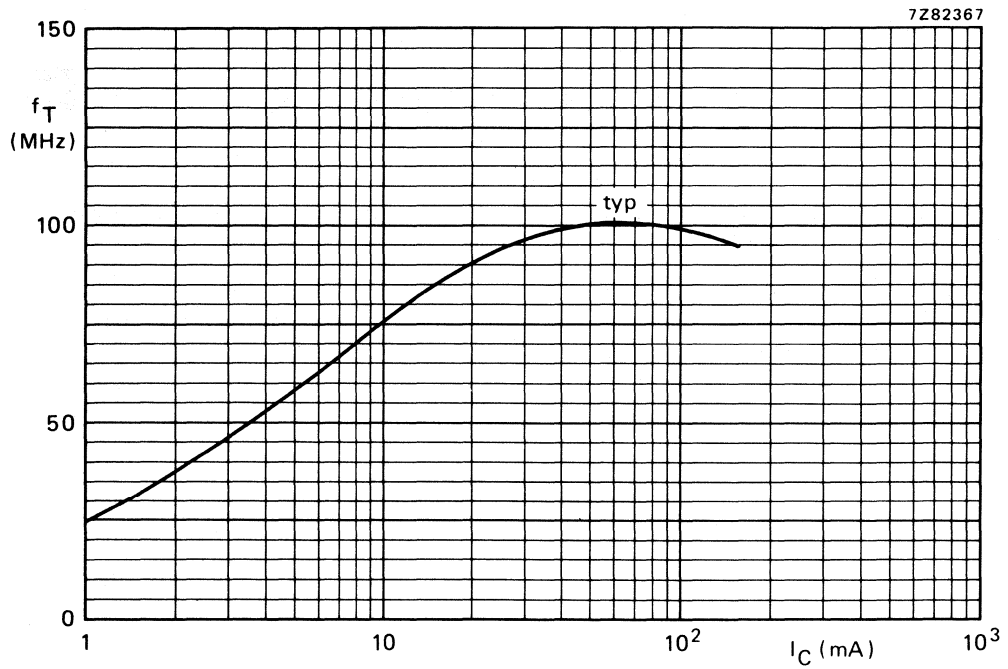

Fig. 15  $V_{CE} = 10$  V;  $f = 20$  MHz;  $T_j = 25$  °C.



## SILICON PLANAR TRANSISTOR



N-P-N double diffused transistor in a TO-39 metal envelope designed for a wide variety of applications such as d.c. and wideband amplifiers.

**QUICK REFERENCE DATA**

Collector-base voltage (open emitter)	$V_{CBO}$	max.	75 V
Collector-emitter voltage ( $R_{BE} \leq 10 \Omega$ )	$V_{CER}$	max.	50 V
Collector current (peak value)	$I_{CM}$	max.	1,0 A
Total power dissipation up to $T_{amb} = 25 \text{ }^\circ\text{C}$	$P_{tot}$	max.	0,8 W
D.C. current gain $I_C = 150 \text{ mA}; V_{CE} = 10 \text{ V}$	$h_{FE}$		100 to 300
Transition frequency at $f = 20 \text{ MHz}$ $I_C = 50 \text{ mA}; V_{CE} = 10 \text{ V}$	$f_T$	>	70 MHz

**MECHANICAL DATA**

Dimensions in mm

Fig. 1 TO-39.

Collector connected to case

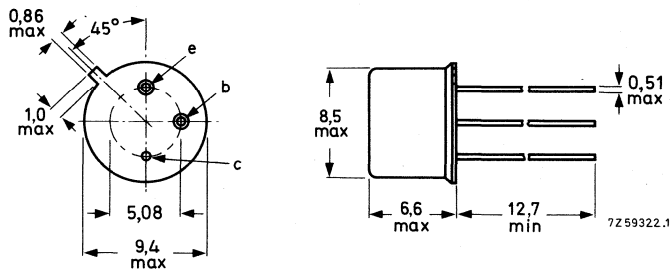

Maximum lead diameter is guaranteed only for 12,7 mm.

**RATINGS**

Limiting values in accordance with the Absolute Maximum System (IEC 134)

Collector-base voltage (open emitter)	$V_{CB0}$	max.	75 V
Collector-emitter voltage ( $R_{BE} \leq 10 \Omega$ )	$V_{CER}$	max.	50 V
Emitter-base voltage (open collector)	$V_{EBO}$	max.	7,0 V
Collector current (peak value)	$I_{CM}$	max.	1,0 A
Total power dissipation			
up to $T_{amb} = 25 \text{ }^\circ\text{C}$	$P_{tot}$	max.	0,8 W
up to $T_{case} = 100 \text{ }^\circ\text{C}$	$P_{tot}$	max.	1,7 W
up to $T_{case} = 25 \text{ }^\circ\text{C}$	$P_{tot}$	max.	3,0 W
Storage temperature range	$T_{stg}$		-65 to + 150 $^\circ\text{C}$
Junction temperature	$T_j$	max.	200 $^\circ\text{C}$
Lead soldering temperature			
> 1,5 mm from the seating plane; $t_{sld} < 10 \text{ s}$	$T_{sld}$	max.	300 $^\circ\text{C}$

**THERMAL RESISTANCE**

From junction to ambient in free air	$R_{th j-a}$	=	219 K/W
From junction to case	$R_{th j-c}$	=	58,3 K/W

**CHARACTERISTICS** $T_{amb} = 25\text{ }^{\circ}\text{C}$  unless otherwise specified

Collector cut-off current

$I_E = 0; V_{CB} = 60\text{ V}$

$I_{CBO} < 10\text{ nA}$

$I_E = 0; V_{CB} = 60\text{ V}; T_{amb} = 150\text{ }^{\circ}\text{C}$

$I_{CBO} < 10\text{ }\mu\text{A}$

Emitter cut-off current

$I_C = 0; V_{EB} = 5,0\text{ V}$

$I_{EBO} < 5\text{ nA}$

Collector-base breakdown voltage

open emitter;  $I_C = 100\text{ }\mu\text{A}$

$V_{(BR)CBO} > 75\text{ V}$

Emitter-base breakdown voltage

open collector;  $I_E = 100\text{ }\mu\text{A}$

$V_{(BR)EBO} > 7,0\text{ V}$

Collector-emitter sustaining voltage \*

$I_C = 100\text{ mA}; R_{BE} \leq 10\text{ }\Omega$

$V_{CERsust} > 50\text{ V}$

Saturation voltages \*

$I_C = 150\text{ mA}; I_B = 15\text{ mA}$

$V_{CEsat} < 0,5\text{ V}$

$V_{BEsat} < 1,3\text{ V}$

D.C. current gain

$I_C = 10\text{ }\mu\text{A}; V_{CE} = 10\text{ V}$

$h_{FE} > 20$

$I_C = 0,1\text{ mA}; V_{CE} = 10\text{ V}$

$h_{FE} > 35$

$I_C = 10\text{ mA}; V_{CE} = 10\text{ V} *$

$h_{FE} > 75$

$I_C = 10\text{ mA}; V_{CE} = 10\text{ V}; T_{amb} = -55\text{ }^{\circ}\text{C}$

$h_{FE} > 35$

$I_C = 150\text{ mA}; V_{CE} = 10\text{ V} *$

$h_{FE} 100\text{ to }300$

$I_C = 500\text{ mA}; V_{CE} = 10\text{ V} *$

$h_{FE} > 40$

Transition frequency at  $f = 20\text{ MHz}$ 

$I_C = 50\text{ mA}; V_{CE} = 10\text{ V}$

$f_T > 70\text{ MHz}$

Collector capacitance

$I_E = I_e = 0; V_{CB} = 10\text{ V}$

$C_c < 25\text{ pF}$

Emitter capacitance

$I_C = I_c = 0; V_{EB} = 0,5\text{ V}$

$C_e < 80\text{ pF}$

Noise figure at  $f = 1\text{ kHz}$ 

$I_C = 300\text{ }\mu\text{A}; V_{CE} = 10\text{ V}; R_S = 510\text{ }\Omega; B = 1\text{ Hz}$

$F < 8,0\text{ dB}$

**h-parameters at  $f = 1\text{ kHz}$** 

Input impedance

$I_C = 1,0\text{ mA}; V_{CB} = 5,0\text{ V}$

$h_{ib} 24\text{ to }34\text{ }\Omega$

$I_C = 5,0\text{ mA}; V_{CB} = 10\text{ V}$

$h_{ib} 4,0\text{ to }8,0\text{ }\Omega$

Reverse voltage transfer ratio

$I_C = 1,0\text{ mA}; V_{CB} = 5,0\text{ V}$

$h_{rb} < 5,0 \cdot 10^{-4}$

$I_C = 5,0\text{ mA}; V_{CB} = 10\text{ V}$

$h_{rb} < 5,0 \cdot 10^{-4}$

Small-signal current gain

$I_C = 1,0\text{ mA}; V_{CE} = 5,0\text{ V}$

$h_{fe} 50\text{ to }200$

$I_C = 5,0\text{ mA}; V_{CE} = 10\text{ V}$

$h_{fe} 70\text{ to }300$

\* Measured under pulse conditions to avoid excessive dissipation:  $t_p \leq 300\text{ }\mu\text{s}; \delta \leq 0,02$ .

2N1711

Output admittance

$I_C = 1,0 \text{ mA}; V_{CE} = 5,0 \text{ V}$

$I_C = 5,0 \text{ mA}; V_{CE} = 10 \text{ V}$

$h_{ob}$  0,05 to 0,5  $\mu\text{S}$

$h_{ob}$  0,05 to 0,5  $\mu\text{S}$

## SILICON TRANSISTOR



High voltage n-p-n transistor in a TO-39 metal envelope with the collector connected to the case. It is intended for use in high performance amplifier, oscillator and switching applications.

## QUICK REFERENCE DATA

Collector-base voltage (open emitter)	$V_{CB0}$	max.	120 V
Collector-emitter voltage ( $R_{BE} \leq 10 \Omega$ )	$V_{CEr}$	max.	100 V
Collector current (d.c.)	$I_C$	max.	500 mA
Total power dissipation up to $T_{case} = 25 \text{ }^\circ\text{C}$	$P_{tot}$	max.	3,0 W
Junction temperature	$T_j$	max.	200 $^\circ\text{C}$
D.C. current gain			
$I_C = 0,1 \text{ mA}; V_{CE} = 10 \text{ V}$	$h_{FE}$	>	20
$I_C = 10 \text{ mA}; V_{CE} = 10 \text{ V}; T = -55 \text{ }^\circ\text{C}$	$h_{FE}$	>	20
$I_C = 10 \text{ mA}; V_{CE} = 10 \text{ V}$	$h_{FE}$	>	35
$I_C = 150 \text{ mA}; V_{CE} = 10 \text{ V}$	$h_{FE}$	40 to	120

## MECHANICAL DATA

Dimensions in mm

Fig. 1 TO-39.

Collector connected to case

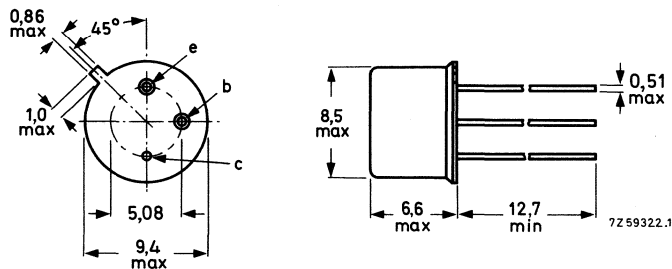

Maximum lead diameter is guaranteed only for 12,7 mm.

**RATINGS**

Limiting values in accordance with the Absolute Maximum System (IEC 134)

Collector-base voltage (open emitter)	$V_{CB0}$	max.	120 V
Collector-emitter voltage (open base)	$V_{CEO}$	max.	80 V
Collector-emitter voltage ( $R_{BE} \leq 10 \Omega$ )	$V_{CER}$	max.	100 V
Emitter-base voltage (open collector)	$V_{EBO}$	max.	7 V
Collector current (d.c.)	$I_C$	max.	500 mA
Total power dissipation up to $T_{amb} = 25 \text{ }^\circ\text{C}$	$P_{tot}$	max.	0,8 W
up to $T_{case} = 100 \text{ }^\circ\text{C}$	$P_{tot}$	max.	1,7 W
up to $T_{case} = 25 \text{ }^\circ\text{C}$	$P_{tot}$	max.	3,0 W
Storage temperature range	$T_{stg}$		-65 to +150 $^\circ\text{C}$
Junction temperature	$T_j$	max.	200 $^\circ\text{C}$

**THERMAL RESISTANCE**

From junction to ambient in free air	$R_{th j-a}$	=	219 K/W
From junction to case	$R_{th j-c}$	=	58,3 K/W

**CHARACTERISTICS**

$T_{amb} = 25\text{ }^{\circ}\text{C}$  unless otherwise specified

**Collector cut-off current**

$I_E = 0; V_{CB} = 90\text{ V}$

$I_{CBO} < 10\text{ nA}$

$I_E = 0; V_{CB} = 90\text{ V}; T_{amb} = 150\text{ }^{\circ}\text{C}$

$I_{CBO} < 15\text{ }\mu\text{A}$

**Emitter cut-off current**

$I_C = 0; V_{EB} = 5\text{ V}$

$I_{EBO} < 10\text{ nA}$

**Collector-emitter sustaining voltage \***

$I_C = 100\text{ mA}; R_{BE} \geq 10\text{ }\Omega$

$V_{CERsust} > 100\text{ V}$

$I_C = 30\text{ mA}; I_B = 0$

$V_{CEO sust} > 80\text{ V}$

**Saturation voltages \***

$I_C = 150\text{ mA}; I_B = 15\text{ mA}$

$V_{CEsat} < 0.5\text{ V}$

$V_{BEsat} < 1.3\text{ V}$

$I_C = 50\text{ mA}; I_B = 5\text{ mA}$

$V_{CEsat} < 0.9\text{ V}$

$V_{BEsat} < 1.2\text{ V}$

**Breakdown voltages**

$I_E = 0; I_C = 100\text{ }\mu\text{A}$

$V_{(BR)CBO} > 120\text{ V}$

$I_C = 0; I_E = 100\text{ }\mu\text{A}$

$V_{(BR)EBO} > 7.0\text{ V}$

**D.C. current gain**

$I_C = 0.1\text{ mA}; V_{CE} = 10\text{ V}$

$h_{FE} > 20$

$I_C = 10\text{ mA}; V_{CE} = 10\text{ V}; T = -55\text{ }^{\circ}\text{C}$

$h_{FE} > 20$

$I_C = 10\text{ mA}; V_{CE} = 10\text{ V} *$

$h_{FE} > 35$

$I_C = 150\text{ mA}; V_{CE} = 10\text{ V} *$

$h_{FE} \quad 40\text{ to }120$

\* Measured under pulsed conditions to avoid excessive dissipation.  
Pulse duration  $t \leq 300\text{ }\mu\text{s}$ , duty cycle  $\delta < 0.02$ .

**CHARACTERISTICS** (continued)h parameters at  $f = 1$  kHz (common base) $I_C = 1$  mA;  $V_{CE} = 5$  V

Input impedance

 $h_{ib}$  20 to 30  $\Omega$ 

Reverse voltage transfer ratio

 $h_{rb}$   $1,25 \cdot 10^{-4}$ 

Output conductance

 $h_{ob}$  0,5  $\mu$ S $I_C = 5$  mA;  $V_{CE} = 10$  V

Input impedance

 $h_{ib}$  4 to 8  $\Omega$ 

Reverse voltage transfer ratio

 $h_{rb}$   $1,50 \cdot 10^{-4}$ 

Output conductance

 $h_{ob}$  0,5  $\mu$ S

Small signal current gain (common emitter)

 $I_C = 1$  mA;  $V_{CE} = 5$  V;  $f = 1$  kHz $h_{fe}$  30 to 100 $I_C = 5$  mA;  $V_{CE} = 10$  V;  $f = 1$  kHz $h_{fe}$  > 45 $I_C = 50$  mA;  $V_{CE} = 10$  V;  $f = 20$  MHz $h_{fe}$  > 2,5

Collector capacitance

 $I_E = I_e = 0$ ;  $V_{CB} = 10$  V $C_c$  < 15 pF

Emitter capacitance

 $I_C = I_c = 0$ ;  $V_{EB} = 0,5$  V $C_e$  < 85 pF



## SILICON PLANAR EPITAXIAL TRANSISTORS



N-P-N transistors in a TO-39 metal envelope with the collector connected to the case. They are primarily intended for high speed switching. The 2N2219 is also suitable for d.c. and v.h.f./u.h.f. amplifiers.

### QUICK REFERENCE DATA

			2N2219	2N2219A	
Collector-base voltage (open emitter)	$V_{CBO}$	max.	60	75	V
Collector-emitter voltage (open base)	$V_{CEO}$	max.	30	40	V
Collector current (d.c.)	$I_C$	max.	800	800	mA
Total power dissipation up to $T_{amb} = 25\text{ }^\circ\text{C}$	$P_{tot}$	max.	0,8	0,8	W
Junction temperature	$T_j$	max.	200	200	$^\circ\text{C}$
D.C. current gain at $T_j = 25\text{ }^\circ\text{C}$ $I_C = 10\text{ mA}; V_{CE} = 10\text{ V}$	$h_{FE}$	>	75	75	
Transition frequency at $f = 100\text{ MHz}$ $I_C = 20\text{ mA}; V_{CE} = 20\text{ V}$	$f_T$	>	250	300	MHz
Storage time $I_C = 150\text{ mA}; I_B = -I_{BM} = 15\text{ mA}$	$t_s$	<	—	225	ns

### MECHANICAL DATA

Dimensions in mm

Fig. 1 TO-39.

Collector connected to case

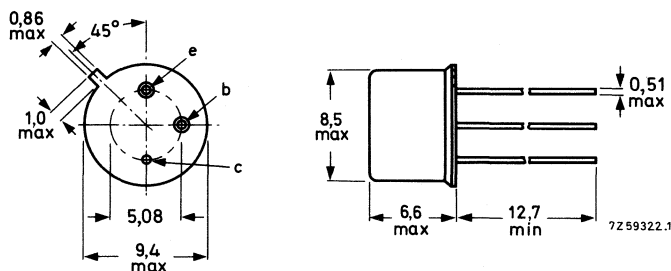

Maximum lead diameter is guaranteed only for 12,7 mm.

### RATINGS

Limiting values in accordance with the Absolute Maximum Ssystem (IEC 134)

			2N2219	2N2219A
Collector-base voltage (open emitter)	$V_{CBO}$	max.	60	75 V
Collector-emitter voltage (open base)	$V_{CEO}$	max.	30	40 V *
Emitter-base voltage (open collector)	$V_{EBO}$	max.	5	6 V
Collector current (d.c.)	$I_C$	max.	800 mA	
Total power dissipation up to $T_{amb} = 25\text{ }^{\circ}\text{C}$	$P_{tot}$	max.	0,8	W
up to $T_{case} = 25\text{ }^{\circ}\text{C}$	$P_{tot}$	max.	3	W
Storage temperature range	$T_{stg}$		-65 to +150	$^{\circ}\text{C}$
Junction temperature	$T_j$	max.	200	$^{\circ}\text{C}$

### THERMAL RESISTANCE

From junction to ambient in free air	$R_{th\ j-a}$	=	190	K/W
From junction to case	$R_{th\ j-c}$	=	50	K/W

### CHARACTERISTICS

$T_j = 25\text{ }^{\circ}\text{C}$  unless otherwise specified

			2N2219	2N2219A
Collector cut-off current $I_E = 0; V_{CB} = 50\text{ V}$	$I_{CBO}$	<	10	- nA
$I_E = 0; V_{CB} = 50\text{ V}; T_{amb} = 150\text{ }^{\circ}\text{C}$	$I_{CBO}$	<	10	- $\mu\text{A}$
$I_E = 0; V_{CB} = 60\text{ V}$	$I_{CBO}$	<	-	10 nA
$I_E = 0; V_{CB} = 60\text{ V}; T_{amb} = 150\text{ }^{\circ}\text{C}$	$I_{CBO}$	<	-	10 $\mu\text{A}$
Emitter cut-off current $I_C = 0; V_{EB} = 3\text{ V}$	$I_{EBO}$	<	10	10 nA
Currents at reverse biased emitter junction $V_{CE} = 60\text{ V}; -V_{BE} = 3\text{ V}$	$I_{CEX}$	<	-	10 nA
	$-I_{BEX}$	<	-	20 nA

\* Applicable up to  $I_C = 500\text{ mA}$

		2N2219	2N2219A
<b>Breakdown voltages</b>			
$I_E = 0; I_C = 10 \mu A$	$V_{(BR)CBO} >$	60	75 V
$I_B = 0; I_C = 10 \text{ mA}$	$V_{(BR)CEO} >$	30	40 V
$I_C = 0; I_E = 10 \mu A$	$V_{(BR)EBO} >$	5	6 V
<b>Saturation voltages *</b>			
$I_C = 150 \text{ mA}; I_B = 15 \text{ mA}$	$V_{CEsat} <$	0,4	0,3 V
	$V_{BEsat} >$	—	0,6 V
	$V_{BEsat} <$	1,3	1,2 V
$I_C = 500 \text{ mA}; I_B = 50 \text{ mA}$	$V_{CEsat} <$	1,6	1,0 V
	$V_{BEsat} <$	2,6	2,0 V
<b>D.C. current gain</b>			
$I_C = 0,1 \text{ mA}; V_{CE} = 10 \text{ V}$	$h_{FE} >$	35	35
$I_C = 1 \text{ mA}; V_{CE} = 10 \text{ V}$	$h_{FE} >$	50	50
$I_C = 10 \text{ mA}; V_{CE} = 10 \text{ V}$	$h_{FE} >$	75	75
$I_C = 10 \text{ mA}; V_{CE} = 10 \text{ V}; T_{amb} = -55 \text{ }^\circ\text{C}$	$h_{FE} >$	—	35
$I_C = 150 \text{ mA}; V_{CE} = 1 \text{ V} *$	$h_{FE} >$	50	50
$I_C = 150 \text{ mA}; V_{CE} = 10 \text{ V} *$	$h_{FE} >$	100 to 300	100 to 300
$I_C = 500 \text{ mA}; V_{CE} = 10 \text{ V} *$	$h_{FE} >$	30	40
<b>Transition frequency at <math>f = 100 \text{ MHz}</math></b>			
$I_C = 20 \text{ mA}; V_{CE} = 20 \text{ V}$	$f_T >$	250	300 MHz
<b>Collector capacitance at <math>f = 100 \text{ kHz}</math></b>			
$I_E = I_e = 0; V_{CB} = 10 \text{ V}$	$C_c <$	8	8 pF
<b>Emitter capacitance at <math>f = 100 \text{ kHz}</math></b>			
$I_C = I_c = 0; V_{EB} = 0,5 \text{ V}$	$C_e <$	—	25 pF
<b>Feedback time constant at <math>f = 31,8 \text{ MHz}</math></b>			
$I_C = 20 \text{ mA}; V_{CE} = 20 \text{ V}$	$r_b, C_c <$	—	150 ps

\* Pulse duration  $\leq 300 \mu s$ ; duty cycle  $\leq 2\%$ .

**h-parameters (common emitter)**

$I_C = 1 \text{ mA}; V_{CE} = 10 \text{ V}; f = 1 \text{ kHz}$

Input impedance

Reverse voltage transfer ratio

Small signal current gain

Output admittance

$I_C = 10 \text{ mA}; V_{CE} = 10 \text{ V}; f = 1 \text{ kHz}$

Input impedance

Reverse voltage transfer ratio

Small signal current gain

Output admittance

$I_C = 20 \text{ mA}; V_{CE} = 20 \text{ V}; f = 100 \text{ MHz}$

Small signal current gain

$I_C = 20 \text{ mA}; V_{CE} = 20 \text{ V}; f = 300 \text{ MHz}$

Real part of input impedance

Noise figure at  $f = 1 \text{ kHz}$

$I_C = 0,1 \text{ mA}; V_{CE} = 10 \text{ V}$

$R_G = 1 \text{ k}\Omega; B = 1 \text{ Hz}$

Switching times for 2N2219A

Turn on time when switched from

$-V_{BE} = 0,5 \text{ V}$  to  $I_C = 150 \text{ mA}; I_B = 15 \text{ mA}$

Delay time

Rise time

**2N2219A**

$h_{ie}$		2 to 8 $\text{k}\Omega$
$h_{re}$	<	$8 \cdot 10^{-4}$
$h_{fe}$		50 to 300
$h_{oe}$		5 to 35 $\mu\text{S}$

$h_{ie}$		0,25 to 1,25 $\text{k}\Omega$
$h_{re}$	<	$4 \cdot 10^{-4}$
$h_{fe}$		75 to 375
$h_{oe}$		25 to 200 $\mu\text{S}$

	2N2219	2N2219A
$h_{fe}$	> 2,5	3,0
$\text{Re}(h_{ie})$	< 60	60 $\Omega$
F	< -	4 dB

$t_d$	<	10 ns
$t_r$	<	25 ns

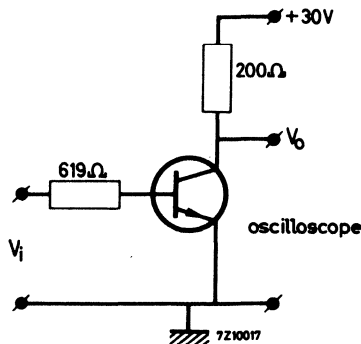
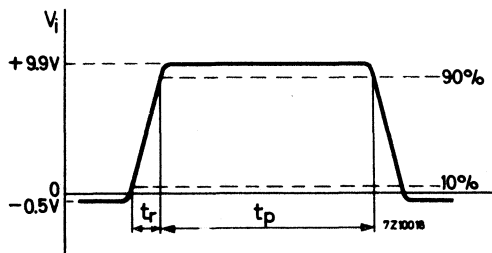

Fig. 2 Test circuit and waveforms.

Pulse generator:

pulse duration  $t_p \leq 200 \text{ ns}$   
rise time  $t_r \leq 2 \text{ ns}$

Oscilloscope:

input resistance  $R_i > 100 \text{ k}\Omega$   
input capacitance  $C_i < 12 \text{ pF}$   
rise time  $t_r < 5 \text{ ns}$

**Switching times for 2N2219A**

Turn off time

$$I_C = 150 \text{ mA}; I_B = -I_{BM} = 15 \text{ mA}$$

Storage time

$$t_s < 225 \text{ ns}$$

Fall time

$$t_f < 60 \text{ ns}$$

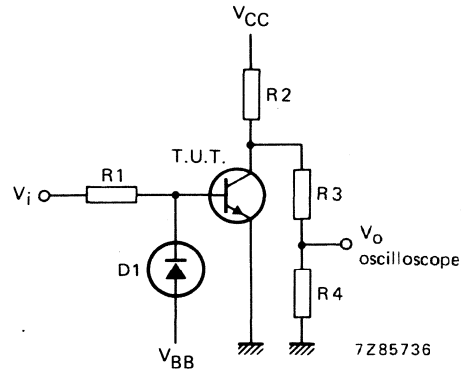
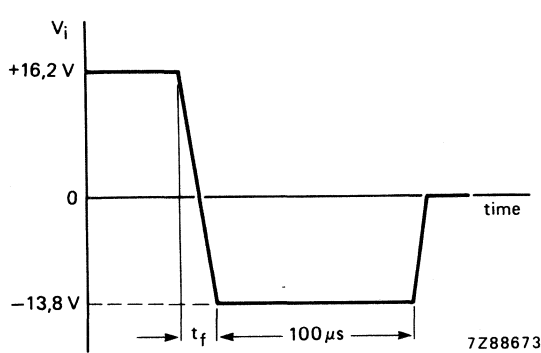

Fig. 3 Test circuit and waveform.

$V_{CC} = +30 \text{ V}; V_{BB} = -3 \text{ V}; R_1 = 1 \text{ k}\Omega; R_2 = 200 \Omega; R_3 = 20 \text{ k}\Omega; R_4 = 50 \Omega; D_1 = 1N916.$

Pulse generator:

fall time  $t_f < 5 \text{ ns}$

Oscilloscope:

input impedance  $R_i > 100 \text{ k}\Omega$   
 input capacitance  $C_i < 12 \text{ pF}$   
 rise time  $t_r < 5 \text{ ns}$



## SILICON PLANAR EPITAXIAL TRANSISTORS



N-P-N transistors in a TO-18 metal envelope with the collector connected to the case. They are primarily intended for high speed switching. The 2N2222 is also suitable for d.c. and v.h.f./u.h.f. amplifiers.

### QUICK REFERENCE DATA

			2N2222	2N2222A	
Collector-base voltage (open emitter)	$V_{CBO}$	max.	60	75	V
Collector-emitter voltage (open base)	$V_{CEO}$	max.	30	40	V
Collector current (d.c.)	$I_C$	max.	800	800	mA
Total power dissipation up to $T_{amb} = 25\text{ }^\circ\text{C}$	$P_{tot}$	max.	0,5	0,5	W
Junction temperature	$T_j$	max.	200	200	$^\circ\text{C}$
D.C. current gain at $T_j = 25\text{ }^\circ\text{C}$ $I_C = 10\text{ mA}$ ; $V_{CE} = 10\text{ V}$	$h_{FE}$	>	75	75	
Transition frequency at $f = 100\text{ MHz}$ $I_C = 20\text{ mA}$ ; $V_{CE} = 20\text{ V}$	$f_T$	>	250	300	MHz
Storage time $I_C = 150\text{ mA}$ ; $I_B = -I_{BM} = 15\text{ mA}$	$t_s$	<	—	225	ns

### MECHANICAL DATA

Dimensions in mm

Fig. 1 TO-18.

Collector connected to case

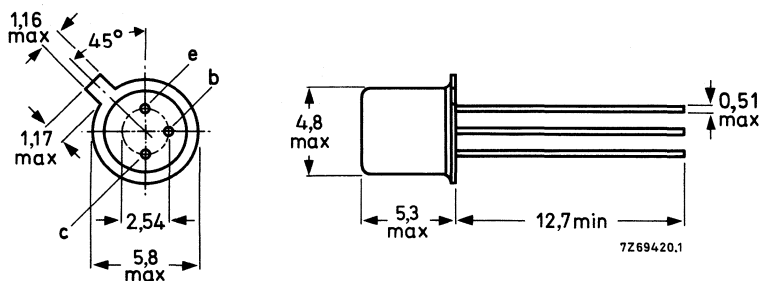

### RATINGS

Limiting values in accordance with the Absolute Maximum System (IEC 134)

		2N2222	2N2222A	
Collector-base voltage (open emitter)	$V_{CBO}$	max. 60	75	V
Collector-emitter voltage (open base)	$V_{CEO}$	max. 30	40*	V
Emitter-base voltage (open collector)	$V_{EBO}$	max. 5	6	V
Collector current (d.c.)	$I_C$	max. 800		mA
Total power dissipation up to $T_{amb} = 25\text{ }^{\circ}\text{C}$	$P_{tot}$	max. 0,5		W
up to $T_{case} = 25\text{ }^{\circ}\text{C}$	$P_{tot}$	max. 1,2		W
Storage temperature range	$T_{stg}$	-65 to + 150		$^{\circ}\text{C}$
Junction temperature	$T_j$	max. 200		$^{\circ}\text{C}$

### THERMAL RESISTANCE

From junction to ambient in free air	$R_{th\ j-a}$	=	350	K/W
From junction to case	$R_{th\ j-c}$	=	146	K/W

### CHARACTERISTICS

$T_j = 25\text{ }^{\circ}\text{C}$  unless otherwise specified

		2N2222	2N2222A	
Collector cut-off current $I_E = 0; V_{CB} = 50\text{ V}$	$I_{CBO}$	< 10	—	nA
$I_E = 0; V_{CB} = 50\text{ V}; T_{amb} = 150\text{ }^{\circ}\text{C}$	$I_{CBO}$	< 10	—	$\mu\text{A}$
$I_E = 0; V_{CB} = 60\text{ V}$	$I_{CBO}$	< —	10	nA
$I_E = 0; V_{CB} = 60\text{ V}; T_{amb} = 150\text{ }^{\circ}\text{C}$	$I_{CBO}$	< —	10	$\mu\text{A}$
Emitter cut-off current $I_C = 0; V_{EB} = 3\text{ V}$	$I_{EBO}$	< 10	10	nA
Currents at reverse biased emitter junction $V_{CE} = 60\text{ V}; -V_{BE} = 3\text{ V}$	$I_{CEX}$	< —	10	nA
	$-I_{BEX}$	< —	20	nA

\* Applicable up to  $I_C = 500\text{ mA}$ .



		2N2222	2N2222A
Breakdown voltages			
$I_E = 0; I_C = 10 \mu\text{A}$	$V_{(BR)CBO} >$	60	75 V
$I_B = 0; I_C = 10 \text{ mA}$	$V_{(BR)CEO} >$	30	40 V
$I_C = 0; I_E = 10 \mu\text{A}$	$V_{(BR)EBO} >$	5	6 V
Saturation voltages *			
$I_C = 150 \text{ mA}; I_B = 15 \text{ mA}$	$V_{CEsat} <$	0,4	0,3 V
	$>$	—	0,6 V
	$V_{BEsat} <$	1,3	1,2 V
	$V_{CEsat} <$	1,6	1,0 V
$I_C = 500 \text{ mA}; I_B = 50 \text{ mA}$	$V_{BEsat} <$	2,6	2,0 V
D.C. current gain			
$I_C = 0,1 \text{ mA}; V_{CE} = 10 \text{ V}$	$h_{FE} >$	35	35
$I_C = 1 \text{ mA}; V_{CE} = 10 \text{ V}$	$h_{FE} >$	50	50
$I_C = 10 \text{ mA}; V_{CE} = 10 \text{ V}$	$h_{FE} >$	75	75
$I_C = 10 \text{ mA}; V_{CE} = 10 \text{ V}; T_{amb} = -55 \text{ }^\circ\text{C}$	$h_{FE} >$	—	35
$I_C = 150 \text{ mA}; V_{CE} = 1 \text{ V} *$	$h_{FE} >$	50	50
$I_C = 150 \text{ mA}; V_{CE} = 10 \text{ V} *$	$h_{FE} >$	100 to 300	100 to 300
$I_C = 500 \text{ mA}; V_{CE} = 10 \text{ V} *$	$h_{FE} >$	30	40
Transition frequency at $f = 100 \text{ MHz}$			
$I_C = 20 \text{ mA}; V_{CE} = 20 \text{ V}$	$f_T >$	250	300 MHz
Collector capacitance at $f = 100 \text{ kHz}$			
$I_E = I_e = 0; V_{CB} = 10 \text{ V}$	$C_c <$	8	8 pF
Emitter capacitance at $f = 100 \text{ kHz}$			
$I_C = I_c = 0; V_{EB} = 0,5 \text{ V}$	$C_e <$	—	25 pF
Feedback time constant at $f = 31,8 \text{ MHz}$			
$I_C = 20 \text{ mA}; V_{CE} = 20 \text{ V}$	$r_b, C_c <$	—	150 ps

\* Pulse duration  $\leq 300 \mu\text{s}$ ; duty cycle  $\leq 2\%$ .

**h-parameters (common emitter)**

$I_C = 1 \text{ mA}; V_{CE} = 10 \text{ V}; f = 1 \text{ kHz}$

Input impedance

Reverse voltage transfer ratio

Small signal current

Output admittance

$I_C = 10 \text{ mA}; V_{CE} = 10 \text{ V}; f = 1 \text{ kHz}$

Input impedance

Reverse voltage transfer ratio

Small signal current gain

Output admittance

$I_C = 20 \text{ mA}; V_{CE} = 20 \text{ V}; f = 100 \text{ MHz}$

Small signal current gain

$I_C = 20 \text{ mA}; V_{CE} = 20 \text{ V}; f = 300 \text{ MHz}$

Real part of input impedance

Noise figure at  $f = 1 \text{ kHz}$

$I_C = 0,1 \text{ mA}; V_{CE} = 10 \text{ V}$

$R_G = 1 \text{ k}\Omega; B = 1 \text{ Hz}$

**Switching times for 2N2222A**

Turn on time when switched from

$-V_{BE} = 0,5 \text{ V}$  to  $I_C = 150 \text{ mA}; I_B = 15 \text{ mA}$

Delay time

Rise time

		<b>2N2222A</b>	
$h_{ie}$		2 to 8 $\text{k}\Omega$	
$h_{re}$	<	$8 \cdot 10^{-4}$	
$h_{fe}$		50 to 300	
$h_{oe}$		5 to 35 $\mu\text{S}$	
$h_{ie}$		0,25 to 1,25 $\text{k}\Omega$	
$h_{re}$	<	$4 \cdot 10^{-4}$	
$h_{fe}$		75 to 375	
$h_{oe}$		25 to 200 $\mu\text{S}$	
		<b>2N2222</b>	<b>2N2222A</b>
$h_{fe}$	>	2,5	3,0
$\text{Re}(h_{ie})$	<	60	60 $\Omega$
F	<	—	4 dB
$t_d$	<	10 ns	
$t_r$	<	25 ns	

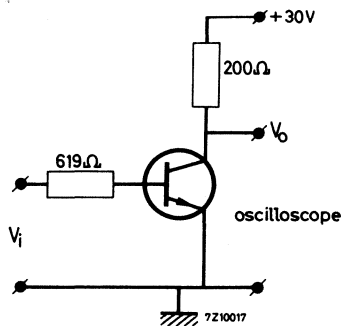
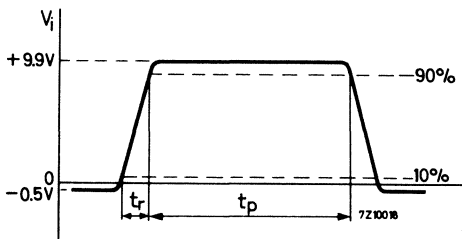

Fig. 2 Test circuit and waveform.

**Pulse generator:**

pulse duration  $t_p \leq 200 \text{ ns}$   
rise time  $t_r \leq 2 \text{ ns}$

**Oscilloscope:**

input resistance  $R_i > 100 \text{ k}\Omega$   
input capacitance  $C_i < 12 \text{ pF}$   
rise time  $t_r < 5 \text{ ns}$

Switching times for 2N2222A

Turn off time

$$I_C = 150 \text{ mA}; I_B = -I_{BM} = 15 \text{ mA}$$

Storage time

Fall time

$$t_s < 225 \text{ ns}$$

$$t_f < 60 \text{ ns}$$

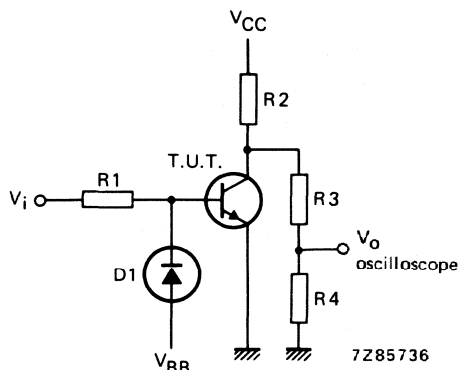
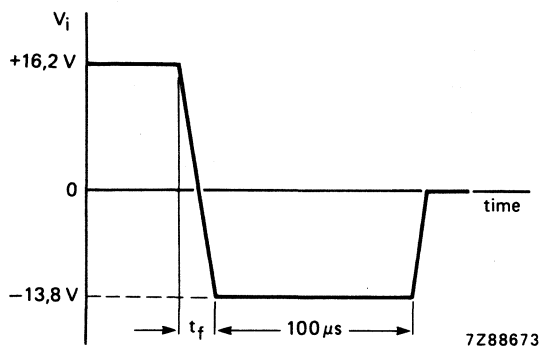

Fig. 3 Test circuit and waveform.

$V_{CC} = +30 \text{ V}; V_{BB} = -3 \text{ V}; R_1 = 1 \text{ k}\Omega; R_2 = 200 \Omega; R_3 = 20 \text{ k}\Omega; R_4 = 50 \Omega; D_1 = 1N916.$

Pulse generator:

fall time  $t_f < 5 \text{ ns}$

Oscilloscope:

input impedance  $R_i > 100 \text{ k}\Omega$   
 input capacitance  $C_i < 12 \text{ pF}$   
 rise time  $t_r < 5 \text{ ns}$



## SILICON PLANAR EPITAXIAL TRANSISTOR

N-P-N transistor intended for large signal h.f. and v.h.f. amplifier applications.

### QUICK REFERENCE DATA

Collector-base voltage (open emitter)	$V_{CBO}$	max.	80 V
Collector-emitter voltage (open base)	$V_{CEO}$	max.	35 V
Collector current (d.c.)	$I_C$	max.	1,0 A
Total power dissipation up to $T_{amb} = 25\text{ }^\circ\text{C}$	$P_{tot}$	max.	0,8 W
Junction temperature	$T_j$	max.	200 $^\circ\text{C}$
D.C. current gain $I_C = 150\text{ mA}; V_{CE} = 10\text{ V}$	$h_{FE}$		40 to 120
Transition frequency at $f = 20\text{ MHz}$ $I_C = 50\text{ mA}; V_{CE} = 10\text{ V}$	$f_T$	>	60 MHz

### MECHANICAL DATA

Dimensions in mm

Fig. 1 TO-39; collector connected to case.

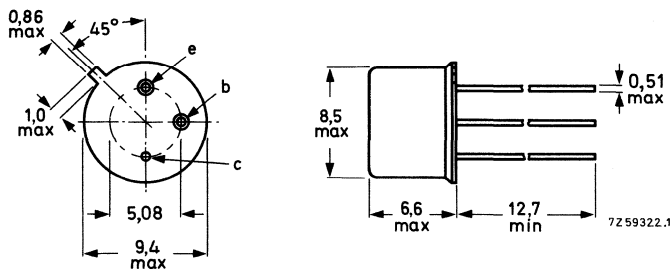

Maximum lead diameter is guaranteed only for 12,7 mm.

**RATINGS**

Limiting values in accordance with the Absolute Maximum System (IEC 134)

Collector-base voltage (open emitter)	$V_{CB0}$	max.	80 V
Collector-emitter voltage (open base)	$V_{CEO}$	max.	35 V
Emitter-base voltage (open collector)	$V_{EB0}$	max.	7,0 V
Collector current (d.c.)	$I_C$	max.	1,0 A
Total power dissipation up to $T_{case} = 25\text{ }^{\circ}\text{C}$	$P_{tot}$	max.	5,0 W
up to $T_{case} = 100\text{ }^{\circ}\text{C}$	$P_{tot}$	max.	2,8 W
up to $T_{amb} = 25\text{ }^{\circ}\text{C}$	$P_{tot}$	max.	0,8 W
Storage temperature range	$T_{stg}$		-65 to +150 $^{\circ}\text{C}$
Junction temperature	$T_j$	max.	200 $^{\circ}\text{C}$

**THERMAL RESISTANCE**

From junction to case	$R_{th\ j-c}$	=	35 K/W
From junction to ambient in free air	$R_{th\ j-a}$	=	219 K/W

**CHARACTERISTICS**

$T_{amb} = 25\text{ }^{\circ}\text{C}$  unless otherwise specified

Collector cut-off current

$$I_E = 0; V_{CB} = 60\text{ V}$$

$$I_{CBO} < 10\text{ nA}$$

$$I_E = 0; V_{CB} = 60\text{ V}; T_{amb} = 150\text{ }^{\circ}\text{C}$$

$$I_{CBO} < 10\text{ }\mu\text{A}$$

Emitter cut-off current

$$I_C = 0; V_{EB} = 5,0\text{ V}$$

$$I_{EBO} < 10\text{ nA}$$

Collector-emitter sustaining voltage\*

$$I_C = 30\text{ mA}; I_B = 0$$

$$V_{CEO\text{sust}} > 35\text{ V}$$

Saturation voltages\*

$$I_C = 150\text{ mA}; I_B = 15\text{ mA}$$

$$V_{CE\text{sat}} < 0,2\text{ V}$$

$$I_C = 1\text{ A}; I_B = 100\text{ mA}^{**}$$

$$V_{CE\text{sat}} < 1,0\text{ V}$$

$$V_{BE\text{sat}} < 1,6\text{ V}$$

D.C. current gain\*

$$I_C = 10\text{ mA}; V_{CE} = 10\text{ V}$$

$$h_{FE} > 30$$

$$I_C = 150\text{ mA}; V_{CE} = 10\text{ V}$$

$$h_{FE} \quad 40\text{ to }120$$

$$I_C = 1,0\text{ A}; V_{CE} = 10\text{ V}$$

$$h_{FE} > 15$$

Feedback time constant

$$I_C = 10\text{ mA}; V_{CB} = 10\text{ V}; f = 4,0\text{ MHz}$$

$$r_{bb}, C_{b'c} < 800\text{ ps}$$

Collector capacitance at  $f = 500\text{ kHz}$

$$I_E = I_e = 0; V_{CB} = 10\text{ V}$$

$$C_c < 12\text{ pF}$$

Emitter capacitance at  $f = 500\text{ kHz}$

$$I_C = I_c = 0; V_{EB} = 0,5\text{ V}$$

$$C_e < 80\text{ pF}$$

Transition frequency at  $f = 20\text{ MHz}$

$$I_C = 50\text{ mA}; V_{CE} = 10\text{ V}$$

$$f_T > 60\text{ MHz}$$

\* Measured under pulse conditions to avoid excessive dissipation:  $t_p = 300\text{ }\mu\text{s}$ ;  $\delta \leq 0,01$ .

\*\* Measured with a lead length of 1 cm.





## SILICON PLANAR EPITAXIAL TRANSISTORS

N-P-N transistor in a TO-18 metal envelope with the collector connected to the case. The 2N2369 is primarily intended for use in very high-speed saturated switching and v.h.f. amplification.

### QUICK REFERENCE DATA

Collector-base voltage (open emitter)	$V_{CBO}$	max.	40 V
Collector-emitter voltage (open base)	$V_{CEO}$	max.	15 V
Collector current (peak value)	$I_{CM}$	max.	500 mA
Total power dissipation up to $T_{amb} = 25\text{ }^{\circ}\text{C}$	$P_{tot}$	max.	360 mW
Junction temperature	$T_j$	max.	200 $^{\circ}\text{C}$
D.C. current gain at $T_j = 25\text{ }^{\circ}\text{C}$ $I_C = 10\text{ mA}; V_{CE} = 1\text{ V}$	$h_{FE}$		40 to 120
Transition frequency $I_C = 10\text{ mA}; V_{CE} = 10\text{ V}$	$f_T$	>	500 MHz
Storage time $I_C = I_B = -I_{BM} = 10\text{ mA}$	$t_s$	<	13 ns

### MECHANICAL DATA

Dimensions in mm

Fig. 1 TO-18.

Collector connected to case

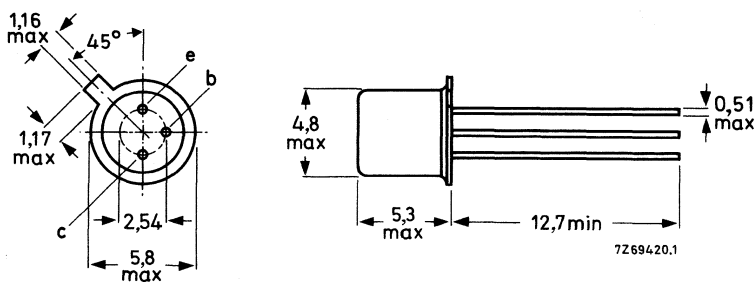

**RATINGS**

Limiting values in accordance with the Absolute Maximum System (IEC 134)

Collector-base voltage (open emitter)	$V_{CBO}$	max.	40 V
Collector-emitter voltage (open base)	$V_{CEO}$	max.	15 V
Collector-emitter voltage with $V_{BE} = 0$	$V_{CES}$	max.	40 V
Emitter-base voltage (open collector)	$V_{EBO}$	max.	4,5 V
Collector current (peak value; $t = 10 \mu\text{s}$ )	$I_{CM}$	max.	500 mA
Total power dissipation up to $T_{amb} = 25 \text{ }^\circ\text{C}$	$P_{tot}$	max.	360 mW
Storage temperature range	$T_{stg}$		-65 to +150 $^\circ\text{C}$
Junction temperature	$T_j$	max.	200 $^\circ\text{C}$

**THERMAL RESISTANCE**

From junction to ambient in free air	$R_{th j-a}$	=	480 K/W
From junction to case	$R_{th j-c}$	=	145 K/W

**CHARACTERISTICS** $T_j = 25 \text{ }^\circ\text{C}$  unless otherwise specified

Collector cut-off current

 $I_E = 0; V_{CB} = 20 \text{ V}$  $I_E = 0; V_{CB} = 20 \text{ V}; T_j = 150 \text{ }^\circ\text{C}$ 

$I_{CBO}$	<	0,4 $\mu\text{A}$
$I_{CBO}$	<	30 $\mu\text{A}$

Sustaining voltage \*

 $I_C = 10 \text{ mA}; I_B = 0$ 

$V_{CEO_{sust}}$	>	15 V*
------------------	---	-------

Saturation voltages

 $I_C = 10 \text{ mA}; I_B = 1 \text{ mA}$ 

$V_{CE_{sat}}$	<	0,25 V
$V_{BE_{sat}}$		0,7 to 0,85 V

Collector capacitance at  $f = 140 \text{ kHz}$  $I_E = I_e = 0; V_{CB} = 5 \text{ V}$ 

$C_c$	<	4 pF
-------	---	------

D.C. current gain\*

 $I_C = 10 \text{ mA}; V_{CE} = 1 \text{ V}$  $I_C = 10 \text{ mA}; V_{CE} = 1 \text{ V}; T_j = -55 \text{ }^\circ\text{C}$  $I_C = 100 \text{ mA}; V_{CE} = 2 \text{ V}$ 

$h_{FE}$		40 to 120
$h_{FE}$	>	20
$h_{FE}$	>	20

Transition frequency

 $I_C = 10 \text{ mA}; V_{CE} = 10 \text{ V}$ 

$f_T$	>	500 MHz
-------	---	---------

\* Measured under pulsed conditions to avoid excessive dissipation.  
Pulse duration  $t = 300 \mu\text{s}$ ; duty cycle  $\delta = 0,01$ .

**CHARACTERISTICS (continued)**

$T_j = 25\text{ }^\circ\text{C}$

Storage time

$I_C = I_B = -I_{BM} = 10\text{ mA}$

$t_s < 13\text{ ns}$

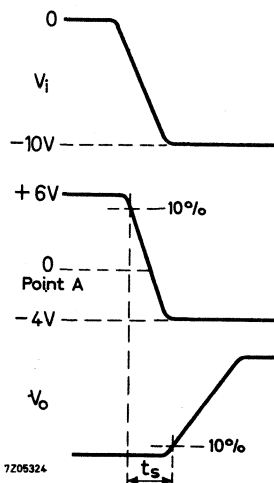
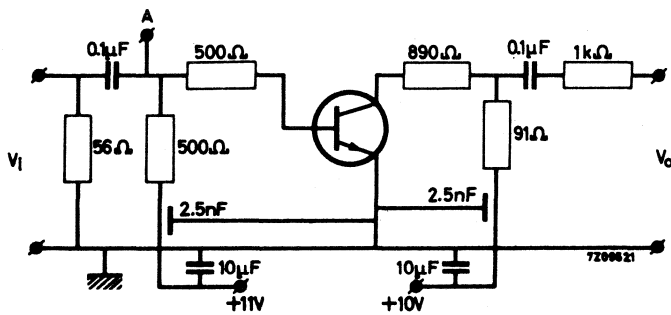

Fig. 2 Test circuit and waveform.

Turn on time

$I_C = 10\text{ mA}; I_B = 3\text{ mA}; -V_{BE} = 1,5\text{ V}$

$t_{on} < 12\text{ ns}$

Turn off time

$I_C = 10\text{ mA}; I_B = 3\text{ mA}; -I_{BM} = 1,5\text{ mA}$

$t_{off} < 18\text{ ns}$

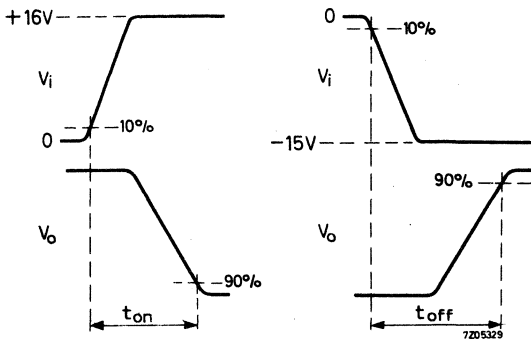
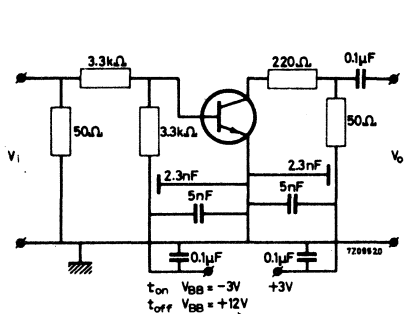

Fig. 3 Test circuit and waveform.

\* Pulse generator

Pulse duration	$t \geq 300\text{ ns}$
Duty cycle	$\delta \leq 0,02$
Rise time	$t_r \leq 1\text{ ns}$
Source impedance	$R_S = 50\ \Omega$

Oscilloscope

Rise time	$t_r \leq 1\text{ ns}$
Input impedance	$R_i = 50\ \Omega$



## SILICON PLANAR EPITAXIAL TRANSISTOR

N-P-N transistor in a TO-18 metal envelope primarily intended for high-speed saturated switching and high frequency amplifier applications.

### QUICK REFERENCE DATA

Collector-base voltage (open emitter)	$V_{CB0}$	max.	40 V
Collector-emitter voltage (open base)	$V_{CE0}$	max.	15 V
Collector current (peak value; $t_p = 10 \mu s$ )	$I_{CM}$	max.	500 mA
Total power dissipation up to $T_{amb} = 25 \text{ }^\circ\text{C}$	$P_{tot}$	max.	360 mW
Junction temperature	$T_j$	max.	200 $^\circ\text{C}$
D.C. current gain at $T_j = 25 \text{ }^\circ\text{C}$			
$I_C = 10 \text{ mA}; V_{CE} = 0,35 \text{ V}$	$h_{FE}$	>	40
$I_C = 10 \text{ mA}; V_{CE} = 1,0 \text{ V}$	$h_{FE}$	<	120
Transition frequency at $f = 100 \text{ MHz}$			
$I_C = 10 \text{ mA}; V_{CE} = 10 \text{ V}$	$f_T$	>	500 MHz
Storage time			
$I_{Con} = I_{Bon} = -I_{Boff} = 10 \text{ mA}$	$t_s$	<	13 ns

### MECHANICAL DATA

Dimensions in mm

Fig. 1 TO-18.

Collector connected to case.

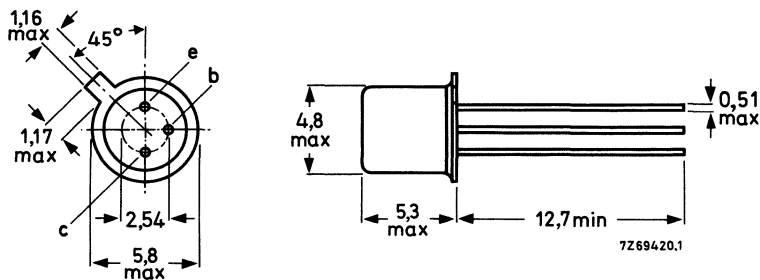

**RATINGS**

Limiting values in accordance with the Absolute Maximum System (IEC 134)

Collector-base voltage (open emitter)	$V_{CBO}$	max.	40 V
Collector-emitter voltage (open base) $I_C = 0,01 \text{ mA to } 10 \text{ mA}$	$V_{CEO}$	max.	15 V
Collector-emitter voltage ( $V_{BE} = 0$ )	$V_{CES}$	max.	40 V
Emitter-base voltage (open collector)	$V_{EBO}$	max.	4,5 V
Collector current (d.c.)	$I_C$	max.	200 mA
Collector current (peak value; $t_p = 10 \mu\text{s}$ )	$I_{CM}$	max.	500 mA
Total power dissipation up to $T_{amb} = 25 \text{ }^\circ\text{C}$	$P_{tot}$	max.	360 mW
up to $T_{case} = 25 \text{ }^\circ\text{C}$	$P_{tot}$	max.	1200 mW
up to $T_{case} = 100 \text{ }^\circ\text{C}$	$P_{tot}$	max.	680 mW
Storage temperature range	$T_{stg}$		$-65 \text{ to } +150 \text{ }^\circ\text{C}$
Junction temperature	$T_j$	max.	200 $^\circ\text{C}$

**THERMAL RESISTANCE**

From junction to ambient in free air	$R_{th j-a}$	=	486 K/W
From junction to case	$R_{th j-c}$	=	146 K/W

## CHARACTERISTICS

$T_{amb} = 25\text{ }^{\circ}\text{C}$  unless otherwise specified

Collector cut-off current

$V_{BE} = 0; V_{CE} = 20\text{ V}$

$I_{CES} < 0,4\text{ }\mu\text{A}$

$I_E = 0; V_{CB} = 20\text{ V}; T_{amb} = 150\text{ }^{\circ}\text{C}$

$I_{CBO} < 30\text{ }\mu\text{A}$

Base current

$V_{BE} = 0; V_{CE} = 20\text{ V}$

$-I_{BEX} < 0,4\text{ }\mu\text{A}$

Collector-base breakdown voltage

open emitter;  $I_C = 10\text{ }\mu\text{A}$

$V_{(BR)CBO} > 40\text{ V}$

Collector-emitter breakdown voltage

$V_{BE} = 0; I_C = 10\text{ }\mu\text{A}$

$V_{(BR)CES} > 40\text{ V}$

Emitter-base breakdown voltage

open collector;  $I_E = 10\text{ }\mu\text{A}$

$V_{(BR)EBO} > 4,5\text{ V}$

Collector-emitter sustaining voltage\*

open base;  $I_C = 10\text{ mA}$

$V_{CEO\text{sust}} > 15\text{ V}$

Saturation voltages

$I_C = 10\text{ mA}; I_B = 1,0\text{ mA}$

$V_{CE\text{sat}} < 0,20\text{ V}$

$V_{BE\text{sat}} 0,70\text{ to }0,85\text{ V}$

$I_C = 10\text{ mA}; I_B = 1,0\text{ mA}; T_{amb} = 125\text{ }^{\circ}\text{C}$

$V_{CE\text{sat}} < 0,30\text{ V}$

$V_{BE\text{sat}} > 0,59\text{ V}$

$I_C = 10\text{ mA}; I_B = 1,0\text{ mA}; T_{amb} = -55\text{ }^{\circ}\text{C}$

$V_{BE\text{sat}} < 1,02\text{ V}$

$I_C = 30\text{ mA}; I_B = 3,0\text{ mA}$

$V_{CE\text{sat}} < 0,25\text{ V}$

$V_{BE\text{sat}} < 1,15\text{ V}$

$I_C = 100\text{ mA}; I_B = 10\text{ mA}$

$V_{CE\text{sat}} < 0,50\text{ V}$

$V_{BE\text{sat}} < 1,60\text{ V}$

D.C. current gain\*

$I_C = 10\text{ mA}; V_{CE} = 0,35\text{ V}$

$h_{FE} > 40$

$I_C = 10\text{ mA}; V_{CE} = 0,35\text{ V}; T_{amb} = -55\text{ }^{\circ}\text{C}$

$h_{FE} > 20$

$I_C = 10\text{ mA}; V_{CE} = 1,0\text{ V}$

$h_{FE} < 120$

$I_C = 30\text{ mA}; V_{CE} = 0,4\text{ V}$

$h_{FE} > 30$

$I_C = 100\text{ mA}; V_{CE} = 1,0\text{ V}$

$h_{FE} > 20$

Collector capacitance at  $f = 140\text{ kHz}$

$I_E = I_e = 0; V_{CB} = 5,0\text{ V}$

$C_C < 4,0\text{ pF}$

Transition frequency at  $f = 100\text{ MHz}$

$I_C = 10\text{ mA}; V_{CE} = 10\text{ V}$

$f_T > 500\text{ MHz}$

\* Measured under pulse conditions to avoid excessive dissipation:  $t_p = 300\text{ }\mu\text{s}; \delta \leq 0,02$ .

Storage time (see Figs 2 and 3)

$$I_{Con} = I_{Bon} = -I_{Boff} = 10 \text{ mA}$$

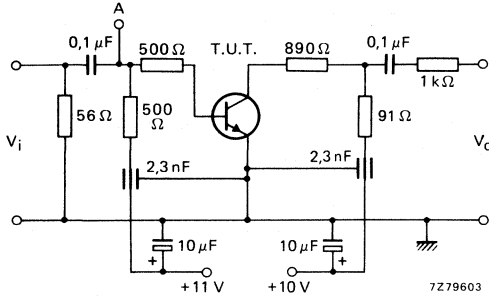

Fig. 2 Storage time test circuit.

$$t_s < 13 \text{ ns}$$

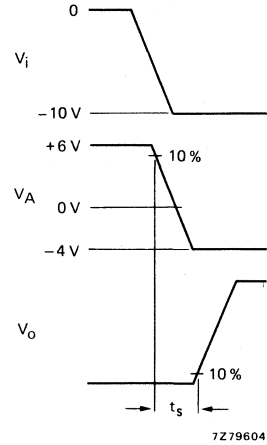

Fig. 3 Waveforms at input, point A and output.

Turn-on time (see Figs 4 and 5)

$$I_{Con} = 10 \text{ mA}; I_{Bon} = 3 \text{ mA}; -V_{BEoff} = 1,5 \text{ V}$$

Turn-off time (see Figs 4 and 5)

$$I_{Con} = 10 \text{ mA}; I_{Bon} = 3 \text{ mA}; -I_{Boff} = 1,5 \text{ mA}$$

$$t_{on} < 12 \text{ ns}$$

$$t_{off} < 18 \text{ ns}$$

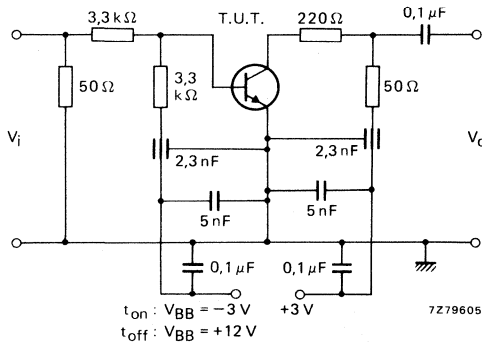

Fig. 4 Turn-on and turn-off test circuit.

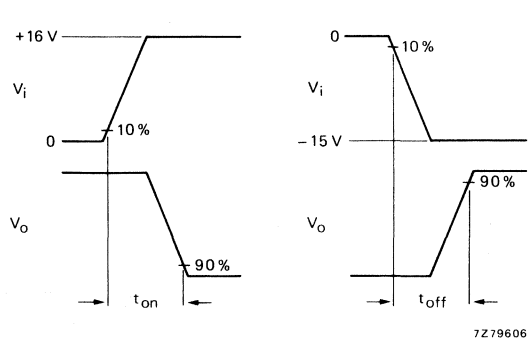

Fig. 5 Input and output waveforms.

Pulse generator:

Rise time	$t_r \leq$	1 ns
Pulse duration	$t_p \geq$	300 ns
Duty factor	$\delta \leq$	0,02
Source impedance	$R_S =$	50 $\Omega$

Oscilloscope:

Rise time	$t_r \leq$	1 ns
Input impedance	$R_i =$	50 $\Omega$



## SILICON PLANAR TRANSISTORS

N-P-N transistors in TO-18 metal envelopes with the collector connected to the case.

These transistors are primarily intended for use in high performance, low-level, low-noise amplifier applications both for direct current and frequencies of up to 100 MHz.

### QUICK REFERENCE DATA

			2N2483	2N2484	
Collector-base voltage (open emitter)	$V_{CBO}$	max	60	60	V
Collector-emitter voltage (open base)	$V_{CEO}$	max	60	60	V
Collector current (peak value)	$I_{CM}$	max	50	50	mA
Total power dissipation up to $T_{amb} = 25\text{ }^{\circ}\text{C}$	$P_{tot}$	max	360	360	mW
Junction temperature	$T_j$	max	200	200	$^{\circ}\text{C}$
D.C. current gain at $T_j = 25\text{ }^{\circ}\text{C}$ $I_C = 10\text{ }\mu\text{A}; V_{CE} = 5\text{ V}$	$h_{FE}$	>	40	100	
		<	120	500	
$I_C = 1\text{ mA}; V_{CE} = 5\text{ V}$	$h_{FE}$	>	175	250	
		<	500	800	
$I_C = 10\text{ mA}; V_{CE} = 5\text{ V}$	$h_{FE}$	>			
		<			
Transition frequency	$f_T$	typ	80	80	MHz
$I_C = 0,5\text{ mA}; V_{CE} = 5\text{ V}$					
Noise figure at $R_S = 10\text{ k}\Omega$ $I_C = 10\text{ }\mu\text{A}; V_{CE} = 5\text{ V}; B = 15,7\text{ kHz}$	F	<	4	3	dB

### MECHANICAL DATA

Dimensions in mm

Fig. 1 TO-18.

Collector connected to case

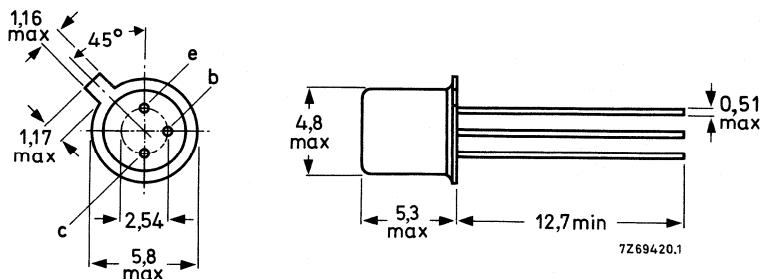

**RATINGS**

Limiting values in accordance with the Absolute Maximum System (IEC 134)

Collector-base voltage (open emitter)	V <sub>CBO</sub>	max.	60 V
Collector-emitter voltage (open base)	V <sub>CEO</sub>	max.	60 V
Emitter-base voltage (open collector)	V <sub>EBO</sub>	max.	6 V
Collector current (peak value)	I <sub>CM</sub>	max.	50 mA
Total power dissipation up to T <sub>amb</sub> = 25 °C	P <sub>tot</sub>	max.	360 mW
Storage temperature range	T <sub>stg</sub>		-65 to +150 °C
Junction temperature	T <sub>j</sub>	max.	200 °C

**THERMAL RESISTANCE**

From junction to ambient in free air	R <sub>th j-a</sub>	=	480 K/W
From junction to case	R <sub>th j-c</sub>	=	150 K/W

**CHARACTERISTICS** $T_j = 25\text{ }^\circ\text{C}$  unless otherwise specified

Collector cut-off current

 $I_E = 0; V_{CB} = 45\text{ V}$  $I_{CBO} < 10\text{ nA}$  $I_E = 0; V_{CB} = 45\text{ V}; T_j = 150\text{ }^\circ\text{C}$  $I_{CBO} < 10\text{ }\mu\text{A}$ 

Emitter cut-off current

 $I_C = 0; V_{EB} = 5\text{ V}$  $I_{EBO} < 10\text{ nA}$ 

Base-emitter voltage

 $I_C = 0,1\text{ mA}; V_{CE} = 5\text{ V}$  $V_{BE} 0,5\text{ to }0,7\text{ V}$ 

Collector-emitter saturation voltage

 $I_C = 1\text{ mA}; I_B = 0,1\text{ mA}$  $V_{CEsat} < 350\text{ mV}$ 

D.C. current gain

 $I_C = 1\text{ }\mu\text{A}; V_{CE} = 5\text{ V}$  $h_{FE} > 30$  $I_C = 10\text{ }\mu\text{A}; V_{CE} = 5\text{ V}$  $h_{FE} 40\text{ to }120$  100 to 500 $I_C = 10\text{ }\mu\text{A}; V_{CE} = 5\text{ V}; T_j = 55\text{ }^\circ\text{C}$  $h_{FE} > 10$  20 $I_C = 100\text{ }\mu\text{A}; V_{CE} = 5\text{ V}$  $h_{FE} > 75$  175 $I_C = 500\text{ }\mu\text{A}; V_{CE} = 5\text{ V}$  $h_{FE} > 100$  200 $I_C = 1\text{ mA}; V_{CE} = 5\text{ V}$  $h_{FE} > 175$  250 $I_C = 10\text{ mA}; V_{CE} = 5\text{ V}^*$  $h_{FE} < 500$  800Collector capacitance at  $f = 1\text{ MHz}$  $I_E = I_e = 0; V_{CB} = 5\text{ V}$  $C_c < 6$  6 pFEmitter capacitance at  $f = 1\text{ MHz}$  $I_C = I_c = 0; V_{EB} = 0,5\text{ V}$  $C_e < 6$  6 pF

Transition frequency

 $I_C = 50\text{ }\mu\text{A}; V_{CE} = 5\text{ V}$  $f_T > 12$  15 MHz $I_C = 500\text{ }\mu\text{A}; V_{CE} = 5\text{ V}$  $f_T >$  60 60 MHz  
typ. 80 80 MHz

Noise figure

 $I_C = 10\text{ }\mu\text{A}; V_{CE} = 5\text{ V}; R_S = 10\text{ k}\Omega$  $f = 100\text{ Hz};$  bandwidth 20 Hz $F < 15$  10 dB $f = 1\text{ kHz};$  bandwidth 200 Hz $F < 4$  3 dB $f = 10\text{ kHz};$  bandwidth 2 kHz $F < 3$  2 dB

Wide band: bandwidth 15,7 kHz

 $F < 4$  3 dB**h parameters at  $f = 1\text{ kHz}$**  $I_C = 1\text{ mA}; V_{CE} = 5\text{ V}$ 

Input impedance

 $h_{ie} 1,5\text{ to }13$  3,5 to 24 k $\Omega$ 

Reverse voltage transfer

 $h_{re} < 8$  8  $10^{-4}$ 

Small signal current gain

 $h_{fe} 80\text{ to }450$  150 to 900

Output admittance

 $h_{oe} < 30$  40  $\mu\text{S}$ \* Measured under pulsed conditions to prevent excessive dissipation.  
Pulse duration  $t < 300\text{ }\mu\text{s}$ ; duty cycle  $\delta < 0,01$ .



Data sheet	
status	Preliminary specification
date of issue	December 1990

# 2N2646

## Silicon unijunction transistor

### QUICK REFERENCE DATA

SYMBOL	PARAMETER	CONDITIONS	MIN.	TYP.	MAX.	UNIT
$-V_{EB2}$	emitter-base 2 voltage		–	–	30	V
$I_{EM}$	emitter current	peak value	–	–	2	A
$P_{tot}$	total power dissipation		–	–	300	mW
$T_j$	junction temperature		–	–	125	°C
$R_{BB}$	static inter-base resistance	$V_{B2B1} = 3\text{ V}$ $I_E = 0$	–	7	–	k $\Omega$
$V_{EB1sat}$	emitter-base 1 saturation voltage	$V_{B2B1} = 10\text{ V}$ $I_E = 50\text{ mA}$	–	3.5	–	V
$I_{E(V)}$	emitter valley point current		4	6	–	mA
$I_{E(P)}$	emitter peak point current		–	1	5	$\mu\text{A}$

### PINNING - TO-18

Base 2 connected to case.

PIN	DESCRIPTION
1	emitter
2	base 1
3	base 2

### PIN CONFIGURATION

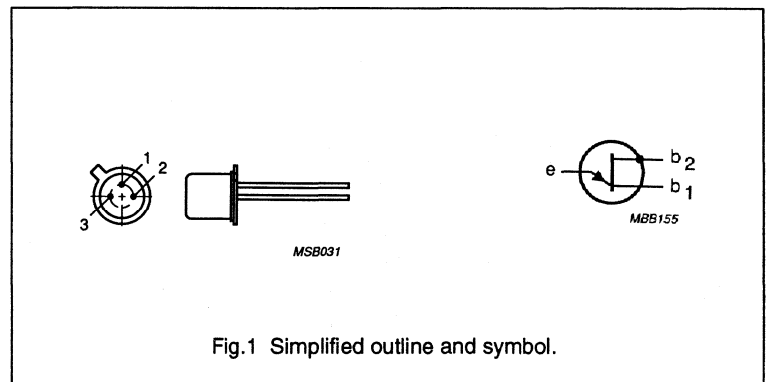

Fig.1 Simplified outline and symbol.

## Silicon unijunction transistor

2N2646

## LIMITING VALUES

In accordance with the Absolute Maximum System (IEC 134).

SYMBOL	PARAMETER	CONDITIONS	MIN.	MAX.	UNIT
$-V_{EB2}$	emitter-base 2 voltage		-	30	V
$V_{B2B1}$	inter-base voltage		-	35	V
$I_E$	emitter current	average value	-	50	mA
$I_{EM}$	emitter current (note 1)	peak value	-	2	A
$P_{tot}$	total power dissipation (note 2)	$T_{amb} \leq 25\text{ }^\circ\text{C}$	-	300	mW
$T_{stg}$	storage temperature range		-65	150	$^\circ\text{C}$
$T_j$	junction temperature		-	125	$^\circ\text{C}$

## Notes

1. Capacitor discharge  $\leq 10\text{ }\mu\text{F}$  at  $\leq 30\text{ V}$ .
2. Must be limited by external circuit.

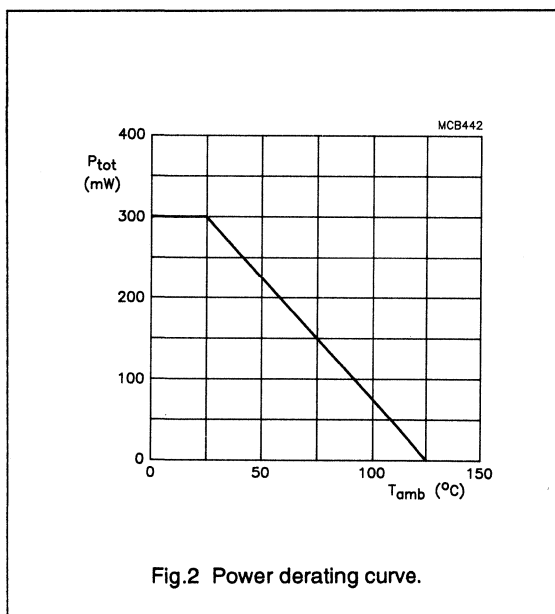

## THERMAL RESISTANCE

SYMBOL	PARAMETER	VALUE	UNIT
$R_{th\ j-a}$	from junction to ambient	300	K/W

# Silicon unijunction transistor

2N2646

## CHARACTERISTICS

T<sub>amb</sub> = 25 °C unless otherwise specified.

SYMBOL	PARAMETER	CONDITIONS	MIN.	TYP.	MAX.	UNIT
R <sub>BB</sub>	static inter-base resistance	V <sub>B2B1</sub> = 3 V I <sub>E</sub> = 0	4.7	7	9.1	kΩ
TC <sub>RBB</sub>	inter-base resistance temperature coefficient	V <sub>B2B1</sub> = 3 V I <sub>E</sub> = 0 T <sub>amb</sub> = -55 to 125 °C	0.1	-	0.9	%/K
-I <sub>EB20</sub>	emitter cut-off current	-V <sub>EB2</sub> = 30 V I <sub>B1</sub> = 0	-	-	12	V
V <sub>EB1sat</sub>	emitter-base 1 saturation voltage	V <sub>B2B1</sub> = 10 V I <sub>E</sub> = 50 mA	-	3.5	-	V
I <sub>B2mod</sub>	inter-base current modulation	V <sub>B2B1</sub> = 10 V I <sub>E</sub> = 50 mA	-	15	-	mA
η	input/output ratio (note 1)	V <sub>B2B1</sub> = 10 V	0.56	-	0.75	
I <sub>E(V)</sub>	emitter valley point current	V <sub>B2B1</sub> = 20 V R <sub>B2</sub> = 100 Ω	4	6	-	mA
I <sub>E(P)</sub>	emitter peak point current	V <sub>B2B1</sub> = 25 V	-	1	5	μA
V <sub>OB1M</sub>	base 1 impulse/output voltage		3	5	-	V

### Note

- $$\eta = \frac{(V_{E(P)} - V_{EB1})}{V_{B2B1}}$$
 when V<sub>E(P)</sub> = emitter peak point voltage, V<sub>EB1</sub> = emitter-base 1 breakdown voltage, (approximately 0.5 V at 10 μA), and V<sub>B2B1</sub> = inter-base voltage.

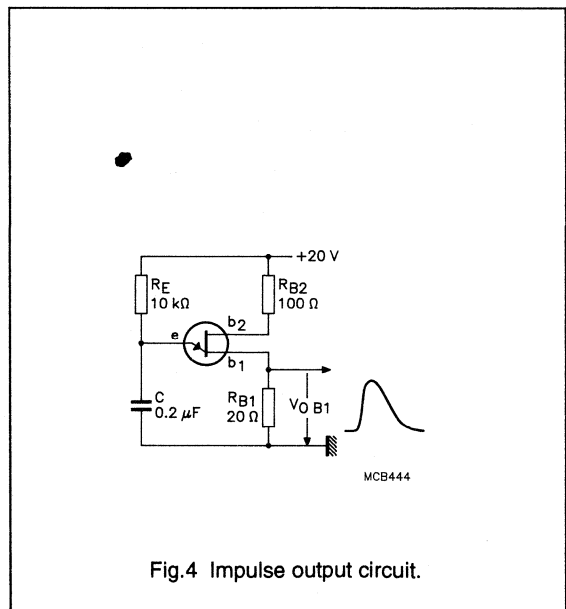
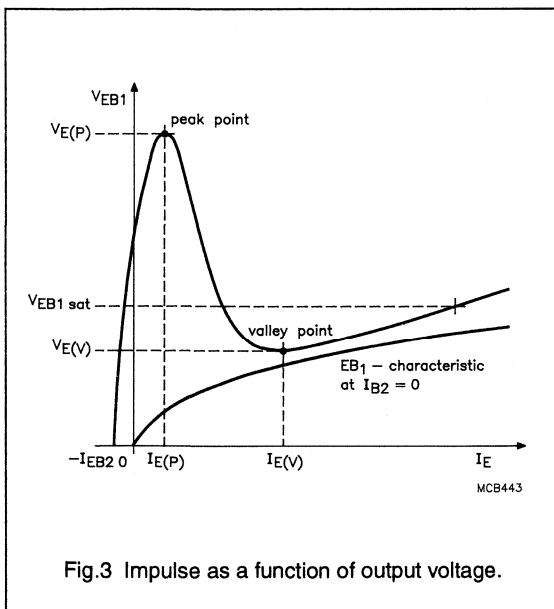

# Silicon unijunction transistor

# 2N2646

## PACKAGE OUTLINE

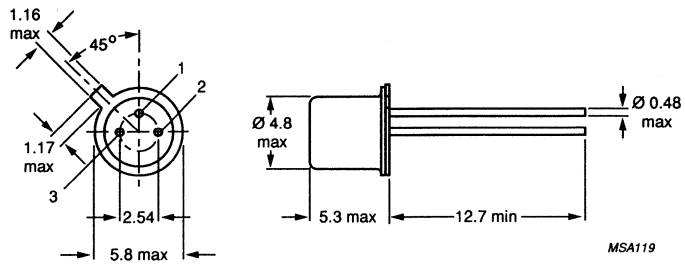

Dimensions in mm.

Fig.5 TO-18.



Data sheet	
status	Preliminary specification
date of issue	December 1990

# 2N2894A

## Silicon switching transistor

### QUICK REFERENCE DATA

SYMBOL	PARAMETER	CONDITIONS	MIN.	MAX.	UNIT
$-V_{CBO}$	collector-base voltage		-	12	V
$-V_{CEO}$	collector-emitter voltage		-	12	V
$-I_C$	collector current		-	200	mA
$P_{tot}$	total power dissipation	$T_{case} \leq 25\text{ }^\circ\text{C}$	-	1.2	W
		$T_{amb} \leq 25\text{ }^\circ\text{C}$	-	360	mW
$T_j$	junction temperature		-	200	$^\circ\text{C}$
$h_{FE}$	current gain	$-V_{CE} = 0.5\text{ V}$ $-I_C = 30\text{ mA}$	40	150	
$f_T$	transition frequency	$-V_{CE} = 10\text{ V}$ $-I_C = 30\text{ mA}$	800	-	MHz
$t_{off}$	turn-off time	$-I_{C\ on} = 30\text{ mA}$ $-I_{B\ on} = I_{B\ off} = 1.5\text{ mA}$	-	35	ns

### PINNING - TO-18

Collector connected to case.

PIN	DESCRIPTION
1	emitter
2	base
3	collector

### PIN CONFIGURATION

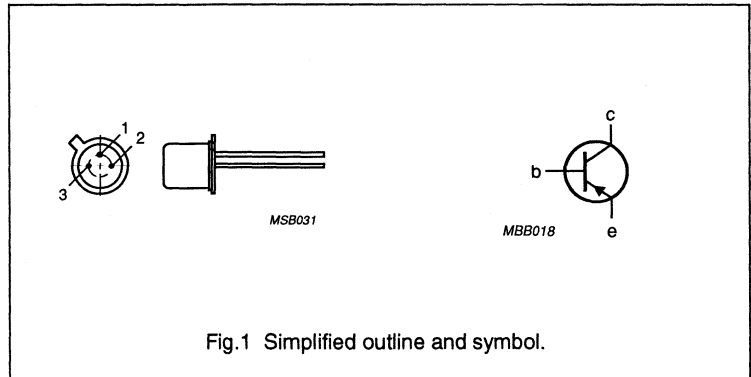

# Silicon switching transistor

# 2N2894A

## LIMITING VALUES

In accordance with the Absolute Maximum System (IEC 134).

SYMBOL	PARAMETER	CONDITIONS	MIN.	MAX.	UNIT
$-V_{CBO}$	collector-base voltage	$I_E = 0$	–	12	V
$-V_{CEO}$	collector-emitter voltage	$I_B = 0$ $-I_C \leq 10 \text{ mA}$	–	12	V
$-V_{EBO}$	emitter-base voltage	$I_C = 0$	–	4.5	V
$-I_C$	collector current		–	200	mA
$P_{tot}$	total power dissipation	$T_{case} \leq 25^\circ\text{C}$	–	1.2	W
		$T_{amb} \leq 25^\circ\text{C}$	–	360	mW
$T_{stg}$	storage temperature range		–65	150	$^\circ\text{C}$
$T_j$	junction temperature		–	200	$^\circ\text{C}$

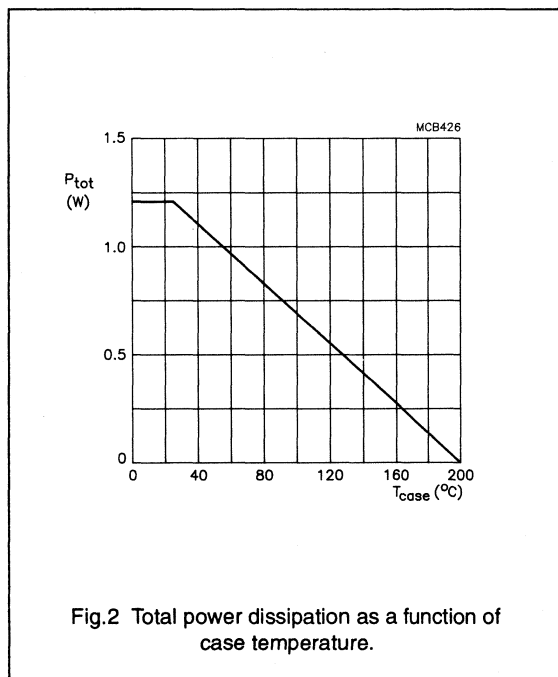

Fig.2 Total power dissipation as a function of case temperature.

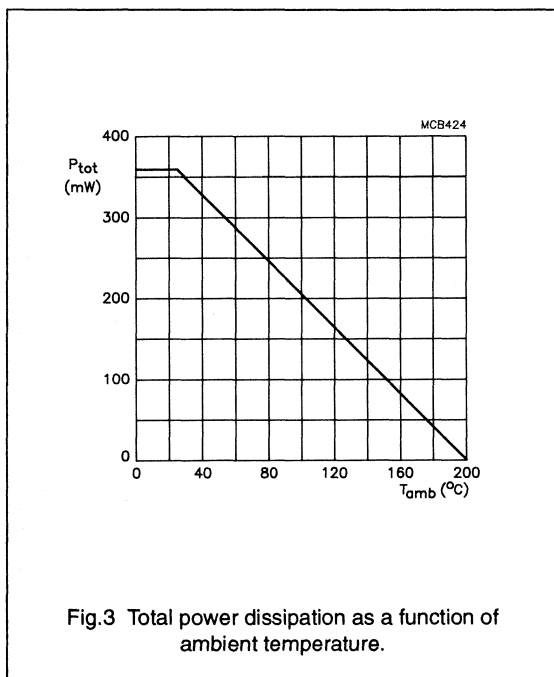

Fig.3 Total power dissipation as a function of ambient temperature.

## THERMAL RESISTANCE

SYMBOL	PARAMETER	VALUE	UNIT
$R_{th\ j-a}$	from junction to ambient	486	K/W
$R_{th\ j-c}$	from junction to case	146	K/W

## Silicon switching transistor

2N2894A

## CHARACTERISTICS

 $T_{amb} = 25\text{ }^{\circ}\text{C}$  unless otherwise specified.

SYMBOL	PARAMETER	CONDITIONS	MIN.	MAX.	UNIT
$-I_{CBO}$	collector cut-off current	$I_E = 0$ $-V_{CB} = 10\text{ V}$ $T_{amb} = 125\text{ }^{\circ}\text{C}$	–	10	$\mu\text{A}$
$-I_{CES}$	collector-emitter cut-off current	$V_{BE} = 0$ $-V_{CE} = 10\text{ V}$	–	50	nA
$-V_{(BR)CBO}$	collector-base breakdown voltage	$I_E = 0$ $-I_C = 10\text{ }\mu\text{A}$	12	–	V
$-V_{(BR)CES}$	collector-emitter breakdown voltage	$I_E = 0$ $-I_C = 10\text{ }\mu\text{A}$	12	–	V
$-V_{(BR)CEO}$	collector-emitter breakdown voltage	$I_B = 0$ $-I_C = 10\text{ mA}$	12	–	V
$-V_{(BR)EBO}$	emitter-base breakdown voltage	$I_C = 0$ $-I_E = 100\text{ }\mu\text{A}$	4.5	–	V
$-V_{CEsat}$	collector-emitter saturation voltage	$-I_B = 1\text{ mA}$ $-I_C = 10\text{ mA}$	–	130	mV
		$-I_B = 3\text{ mA}$ $-I_C = 30\text{ mA}$	–	190	mV
		$-I_B = 10\text{ mA}$ $-I_C = 100\text{ mA}$	–	450	mV
$-V_{BEsat}$	base-emitter saturation voltage	$-I_B = 1\text{ mA}$ $-I_C = 10\text{ mA}$	780	920	mV
		$-I_B = 3\text{ mA}$ $-I_C = 30\text{ mA}$	0.85	1.15	V
		$-I_B = 10\text{ mA}$ $-I_C = 100\text{ mA}$	–	1.5	V
$h_{FE}$	current gain	$-V_{CE} = 0.5\text{ V}$ $-I_C = 1\text{ mA}$	20	–	
		$-V_{CE} = 0.3\text{ V}$ $-I_C = 10\text{ mA}$	30	–	
		$-V_{CE} = 0.5\text{ V}$ $-I_C = 30\text{ mA}$	40	150	
		$-V_{CE} = 0.5\text{ V}$ $-I_C = 30\text{ mA}$ $T_{amb} = -55\text{ }^{\circ}\text{C}$	20	–	
		$-V_{CE} = 1\text{ V}$ $-I_C = 100\text{ mA}$	30	–	
$f_T$	transition frequency	$-V_{CE} = 10\text{ V}$ $-I_C = 30\text{ mA}$ $f = 100\text{ MHz}$	800	–	MHz
$C_c$	collector capacitance	$-V_{CB} = 5\text{ V}$ $I_E = 0$ $f = 140\text{ kHz}$	–	4.5	pF

# Silicon switching transistor

# 2N2894A

SYMBOL	PARAMETER	CONDITIONS	MIN.	MAX.	UNIT
$C_e$	emitter capacitance	$-V_{EB} = 0.5 \text{ V}$ $I_C = 0$ $f = 140 \text{ kHz}$	—	6	pF
<b>Switching times</b>					
$t_{on}$	turn-on time (Fig.4)	$-I_{C \text{ on}} = 30 \text{ mA}$ $-I_{B \text{ on}} = I_{B \text{ off}} = 1.5 \text{ mA}$	—	60	ns
$t_{off}$	turn-off time (Fig.4)	$-I_{C \text{ on}} = 30 \text{ mA}$ $-I_{B \text{ on}} = I_{B \text{ off}} = 1.5 \text{ mA}$	—	35	ns
$t_{on}$	turn-on time (Fig.5)	$-I_{C \text{ on}} = 30 \text{ mA}$ $-I_{B \text{ on}} = I_{B \text{ off}} = 3 \text{ mA}$ $-I_{C \text{ on}} = -I_{B \text{ on}} = I_{B \text{ off}} = 10 \text{ mA}$	—	20	ns
$t_{off}$	turn-off time (Fig.5)	$-I_{C \text{ on}} = 30 \text{ mA}$ $-I_{B \text{ on}} = I_{B \text{ off}} = 3 \text{ mA}$ $-I_{C \text{ on}} = -I_{B \text{ on}} = I_{B \text{ off}} = 10 \text{ mA}$	—	25	ns
$t_s$	storage time factor	$-I_{C \text{ on}} = 30 \text{ mA}$ $-I_{B \text{ on}} = I_{B \text{ off}} = 3 \text{ mA}$ $-I_{C \text{ on}} = -I_{B \text{ on}} = I_{B \text{ off}} = 10 \text{ mA}$	—	20	ns

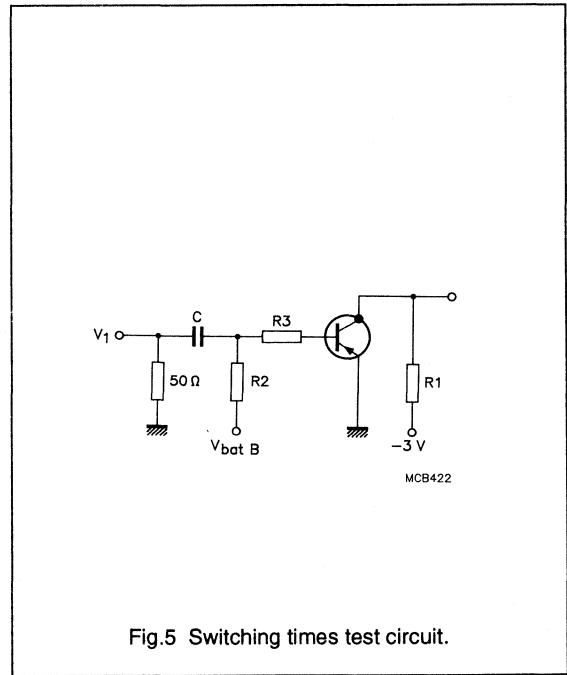
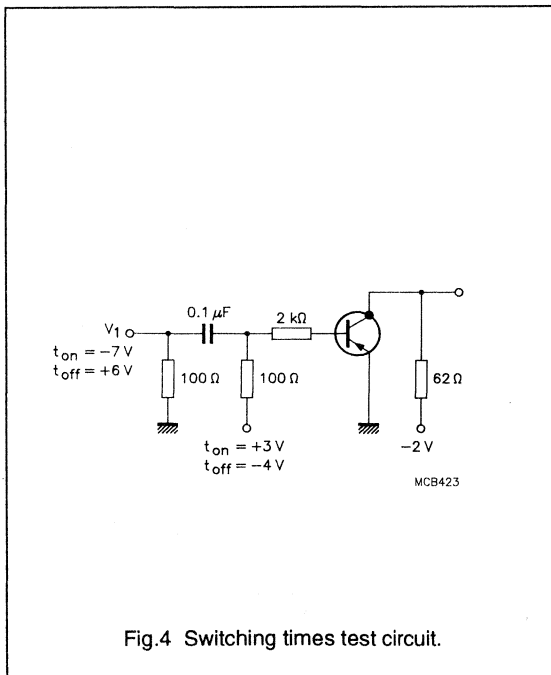

Silicon switching transistor

2N2894A

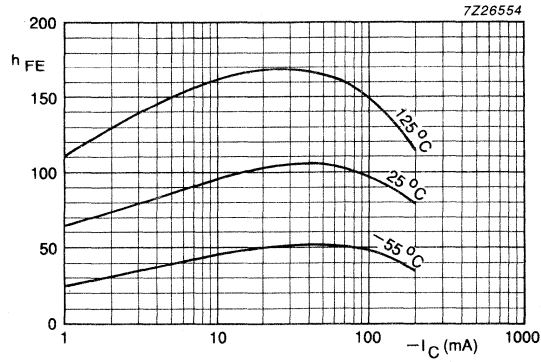

Fig.6 Current gain as a function of collector current;  $-V_{CE} = 5$  V.

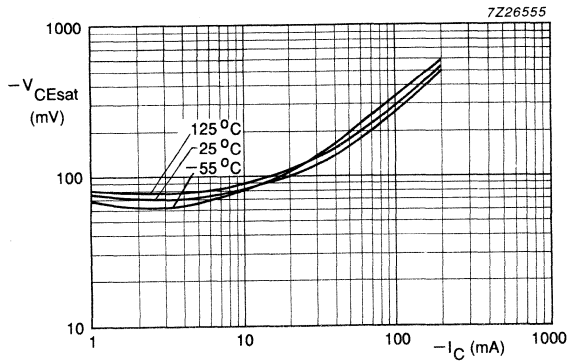

Fig.7 Collector-emitter saturation voltage as a function of collector current;  $I_C:I_B = 10$ .

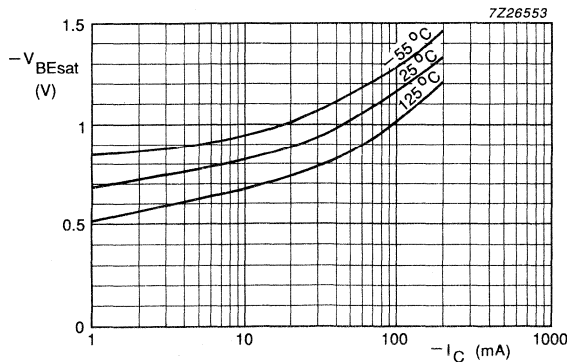
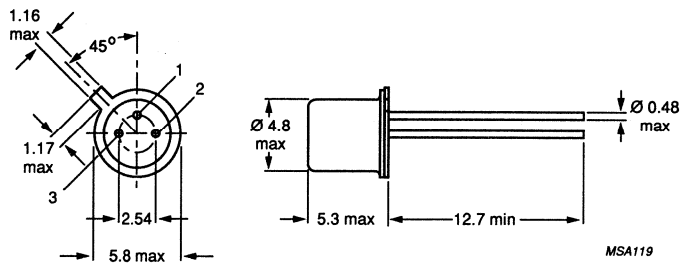

Fig.8 Base-emitter saturation voltage as a function of collector current;  $I_C:I_B = 10$ .

# Silicon switching transistor

# 2N2894A

## PACKAGE OUTLINE



Dimensions in mm.

Fig.9 TO-18.

## SILICON PLANAR EPITAXIAL TRANSISTORS



P-N-P transistors in TO-39 metal envelopes designed primarily for high-speed switching and driver applications for industrial service.

### QUICK REFERENCE DATA

Collector-base voltage (open emitter)		$-V_{CBO}$	max.	60 V
Collector-emitter voltage (open base)	2N2904	$-V_{CEO}$	max.	40 V
	2N2904A	$-V_{CEO}$	max.	60 V
Collector current (d.c.)		$-I_C$	max.	600 mA
Total power dissipation up to $T_{amb} = 25\text{ }^\circ\text{C}$		$P_{tot}$	max.	0,6 W
Junction temperature		$T_j$	max.	200 $^\circ\text{C}$
D.C. current gain at $T_j = 25\text{ }^\circ\text{C}$ $-I_C = 150\text{ mA}; -V_{CE} = 10\text{ V}$		$h_{FE}$		40 to 120
Transition frequency at $f = 100\text{ MHz}$ $-I_C = 50\text{ mA}; -V_{CE} = 20\text{ V}; T_j = 25\text{ }^\circ\text{C}$		$f_T$	>	200 MHz
Storage time $-I_{Con} = 150\text{ mA}; -I_{Bon} = I_{Boff} = 15\text{ mA}$		$t_s$	<	80 ns

### MECHANICAL DATA

Dimensions in mm

Fig. 1 TO-39.

Collector connected to case.

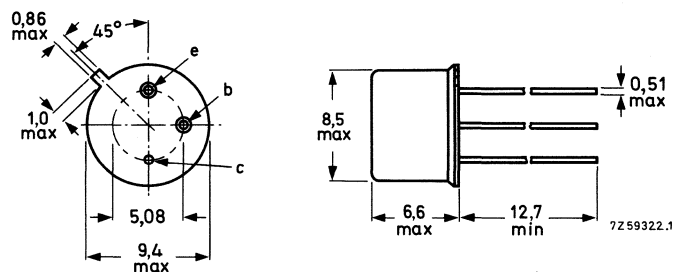

Maximum lead diameter is guaranteed only for 12,7 mm.

**RATINGS**

Limiting values in accordance with the Absolute Maximum System (IEC 134)

Collector-base voltage (open emitter)		$-V_{CBO}$	max.	60 V
Collector-emitter voltage (open base) $-I_C < 100 \text{ mA}$	<b>2N2904</b>	$-V_{CEO}$	max.	40 V
	<b>2N2904A</b>	$-V_{CEO}$	max.	60 V
Emitter-base voltage (open collector)		$-V_{EBO}$	max.	5 V
Collector current (d.c.)		$-I_C$	max.	600 mA
Total power dissipation up to $T_{amb} = 25 \text{ }^\circ\text{C}$		$P_{tot}$	max.	0,6 W
		$P_{tot}$	max.	3,0 W
Storage temperature range		$T_{stg}$		-65 to +150 $^\circ\text{C}$
Junction temperature		$T_j$	max.	200 $^\circ\text{C}$

**THERMAL RESISTANCE**

From junction to ambient in free air	$R_{th j-a}$	=	292 K/W
From junction to case	$R_{th j-c}$	=	58 K/W



## CHARACTERISTICS

 $T_{amb} = 25\text{ }^{\circ}\text{C}$  unless otherwise specified

Collector cut-off current

$I_E = 0; -V_{CB} = 50\text{ V}$

$-I_{CBO} < 20 \quad 10\text{ nA}$

$I_E = 0; -V_{CB} = 50\text{ V}; T_{amb} = 150\text{ }^{\circ}\text{C}$

$-I_{CBO} < 20 \quad 10\text{ }\mu\text{A}$

$+V_{BE} = 0,5\text{ V}; -V_{CE} = 30\text{ V}$

$-I_{CEX} < 50 \quad 50\text{ nA}$

Base current

$+V_{BE} = 0,5\text{ V}; -V_{CE} = 30\text{ V}$

$I_{BEX} < 50 \quad 50\text{ nA}$

Collector-base breakdown voltage

open emitter;  $-I_C = 10\text{ }\mu\text{A}$

$-V_{(BR)CBO} > 60 \quad 60\text{ V}$

Collector-emitter breakdown voltage \*

open base;  $-I_C = 10\text{ mA}$

$-V_{(BR)CEO} > 40 \quad 60\text{ V}$

Emitter-base breakdown voltage

open collector;  $-I_E = 10\text{ }\mu\text{A}$

$-V_{(BR)EBO} > 5 \quad 5\text{ V}$

Saturation voltages \*

$-I_C = 150\text{ mA}; -I_B = 15\text{ mA}$

$-V_{CEsat} < 0,4 \quad 0,4\text{ V}$

$-V_{BEsat} < 1,3 \quad 1,3\text{ V}$

$-I_C = 500\text{ mA}; -I_B = 50\text{ mA}$

$-V_{CEsat} < 1,6 \quad 1,6\text{ V}$

$-V_{BEsat} < 2,6 \quad 2,6\text{ V}$

D.C. current gain

$-I_C = 0,1\text{ mA}; -V_{CE} = 10\text{ V}$

$h_{FE} > 20 \quad 40$

$-I_C = 1\text{ mA}; -V_{CE} = 10\text{ V}$

$h_{FE} > 25 \quad 40$

$-I_C = 10\text{ mA}; -V_{CE} = 10\text{ V}$

$h_{FE} > 35 \quad 40$

$-I_C = 150\text{ mA}; -V_{CE} = 10\text{ V} *$

$h_{FE} > 40 \quad 40$

$h_{FE} < 120 \quad 120$

$-I_C = 500\text{ mA}; -V_{CE} = 10\text{ V} *$

$h_{FE} > 20 \quad 40$

Collector capacitance at  $f = 100\text{ kHz}$ 

$I_E = I_e = 0; -V_{CB} = 10\text{ V}$

$C_c < 8 \quad \text{pF}$

Emitter capacitance at  $f = 100\text{ kHz}$ 

$I_C = I_c = 0; -V_{EB} = 2\text{ V}$

$C_e < 30 \quad \text{pF}$

Transition frequency at  $f = 100\text{ MHz}$ 

$-I_C = 50\text{ mA}; -V_{CE} = 20\text{ V} *$

$f_T > 200 \quad \text{MHz}$

\* Measured under pulse conditions to avoid excessive dissipation:  $t_p \leq 300\text{ }\mu\text{s}; \delta \leq 0,02$ .

Turn-on time (see Fig. 2)

when switched to  $-I_{Con} = 150 \text{ mA}$ ;  $-I_{Bon} = 15 \text{ mA}$

delay time

rise time

turn-on time

$t_d < 10 \text{ ns}$   
 $t_r < 40 \text{ ns}$   
 $t_{on} < 45 \text{ ns}$

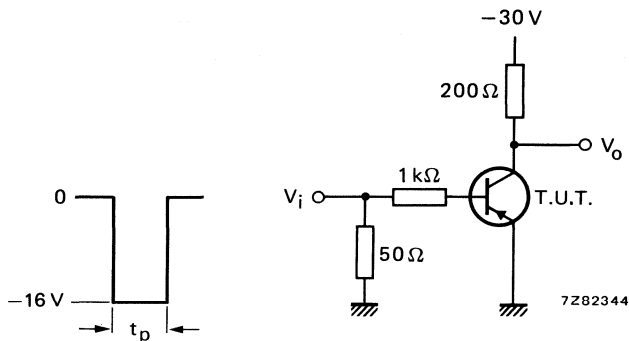

Fig. 2 Input waveform and test circuit for determining delay, rise and turn-on time.

Turn-off time (see Fig. 3)

when switched from  $-I_{Con} = 150 \text{ mA}$ ;  $-I_{Bon} = 15 \text{ mA}$

to cut-off with  $+I_{Boff} = 15 \text{ mA}$

storage time

turn-off time

$t_s < 80 \text{ ns}$   
 $t_{off} < 100 \text{ ns}$

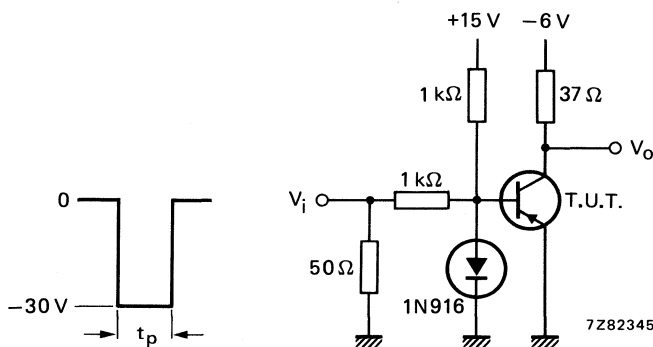

Fig. 3 Input waveform and test circuit for determining storage, fall and turn-off time.

Pulse generator (see Figs 2 and 3)

frequency  $f = 150 \text{ Hz}$   
pulse duration  $t_p = 200 \text{ ns}$   
rise time  $t_r \leq 2 \text{ ns}$   
output impedance  $Z_o = 50 \Omega$

Oscilloscope (see Figs 2 and 3)

rise time  $t_r \leq 5 \text{ ns}$   
input impedance  $Z_i = 10 \text{ M}\Omega$

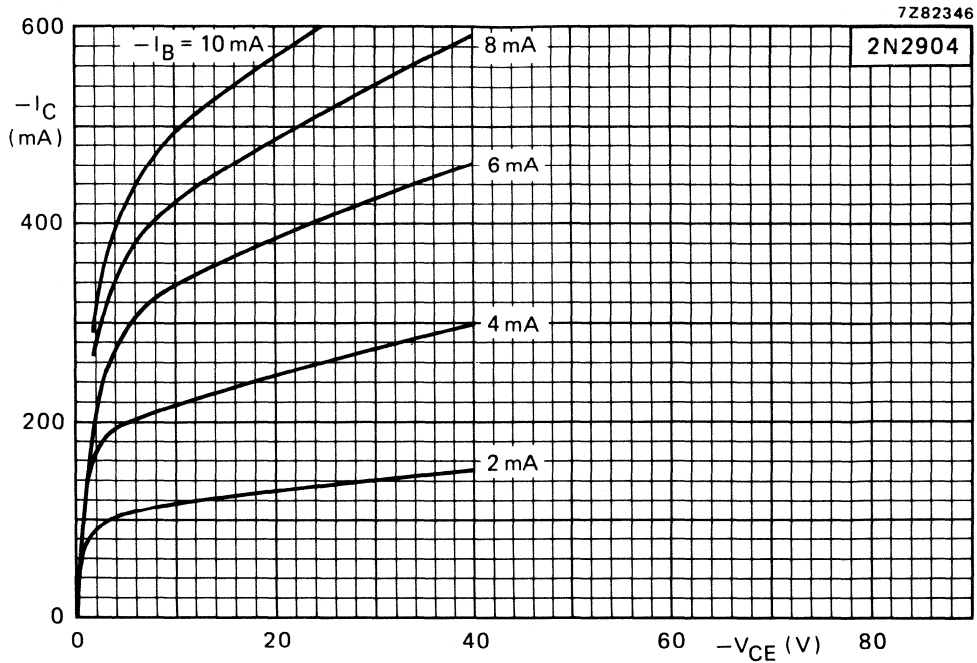

Fig. 4 Typical values;  $T_j = 25^\circ\text{C}$ .

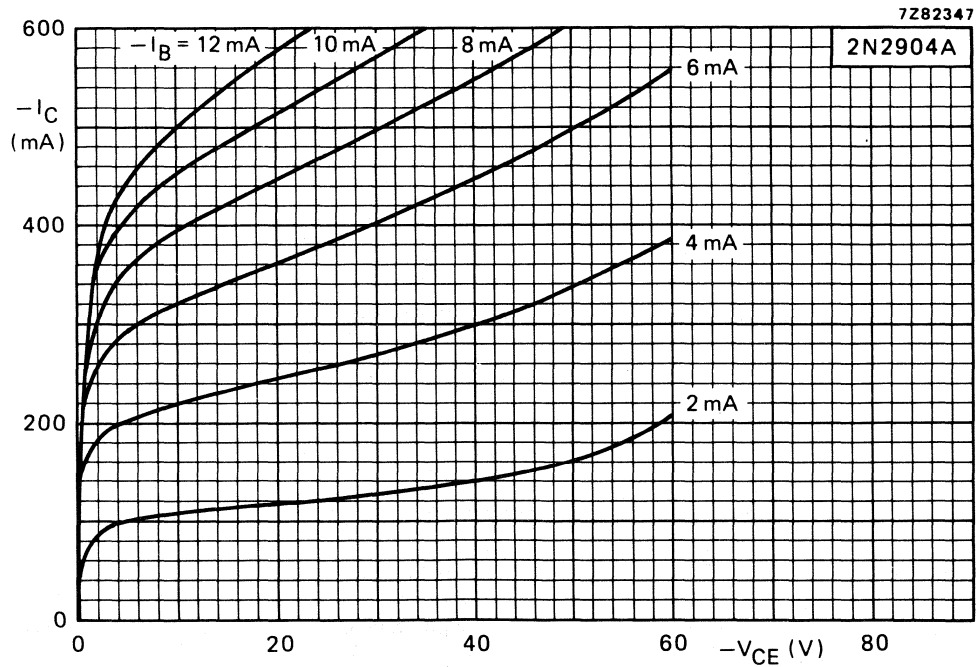

Fig. 5 Typical values;  $T_j = 25^\circ\text{C}$ .

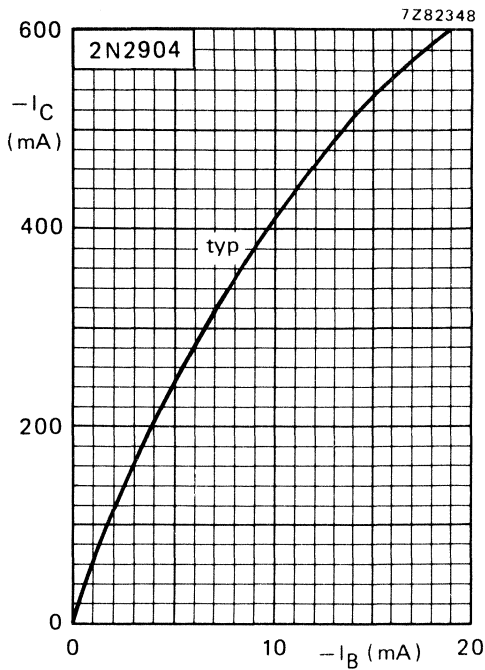

Fig. 6  $-V_{CE} = 5,0 \text{ V}$ ;  $T_j = 25 \text{ }^\circ\text{C}$ .

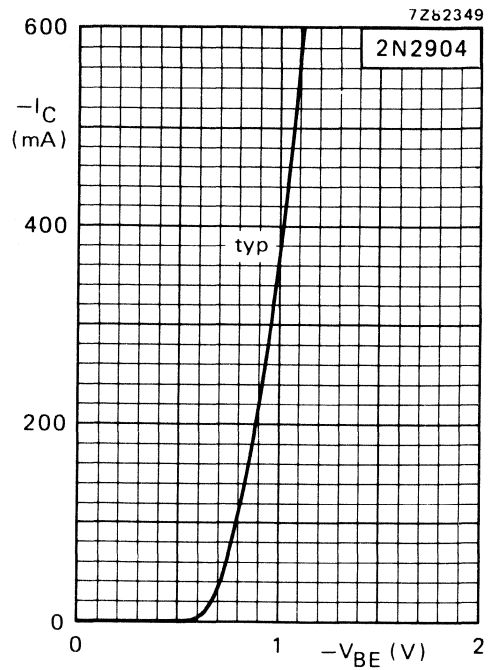

Fig. 7  $-V_{CE} = 5,0 \text{ V}$ ;  $T_j = 25 \text{ }^\circ\text{C}$ .

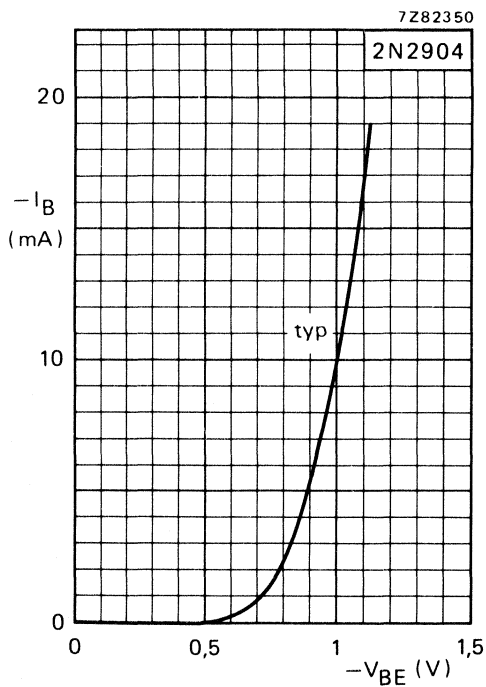

Fig. 8  $-V_{CE} = 5,0 \text{ V}$ ;  $T_j = 25 \text{ }^\circ\text{C}$ .

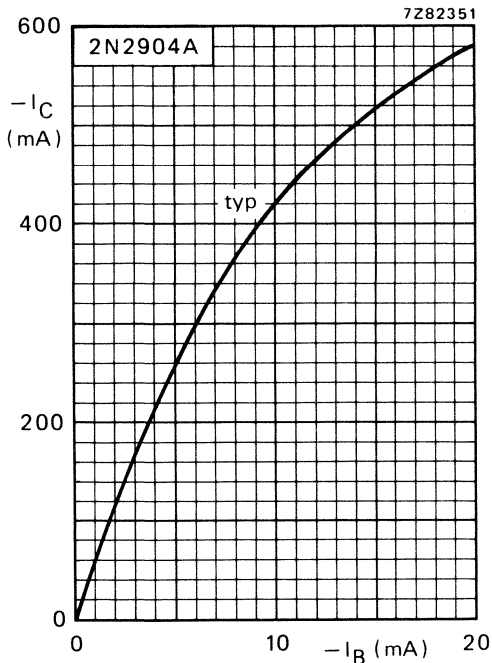

Fig. 9  $-V_{CE} = 5,0$  V;  $T_j = 25$  °C.

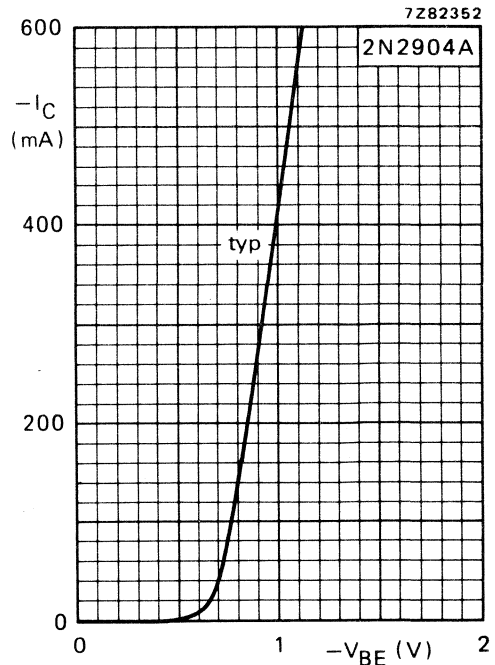

Fig. 10  $-V_{CE} = 5,0$  V;  $T_j = 25$  °C.

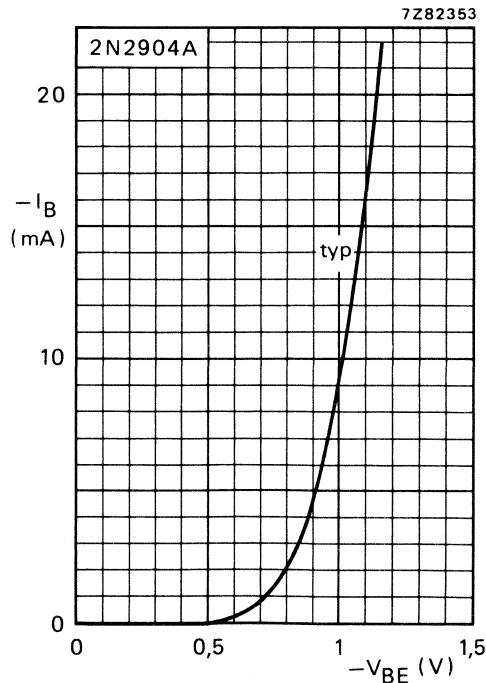

Fig. 11  $-V_{CE} = 5,0$  V;  $T_j = 25$  °C.



## SILICON PLANAR EPITAXIAL TRANSISTORS



P-N-P transistors in TO-39 metal envelopes designed primarily for high-speed switching and driver applications for industrial service.

### QUICK REFERENCE DATA

Collector-base voltage (open emitter)		$-V_{CBO}$	max.	60 V
Collector-emitter voltage (open base)	2N2905	$-V_{CEO}$	max.	40 V
	2N2905A	$-V_{CEO}$	max.	60 V
Collector current (d.c.)		$-I_C$	max.	600 mA
Total power dissipation up to $T_{amb} = 25\text{ }^\circ\text{C}$		$P_{tot}$	max.	0,6 W
Junction temperature		$T_j$	max.	200 $^\circ\text{C}$
D.C. current gain at $T_j = 25\text{ }^\circ\text{C}$ $-I_C = 150\text{ mA}; -V_{CE} = 10\text{ V}$		$h_{FE}$		100 to 300
Transition frequency at $f = 100\text{ MHz}$ $-I_C = 50\text{ mA}; -V_{CE} = 20\text{ V}; T_j = 25\text{ }^\circ\text{C}$		$f_T$	>	200 MHz
Storage time $-I_{Con} = 150\text{ mA}; -I_{Bon} = I_{Boff} = 15\text{ mA}$		$t_s$	<	80 ns

### MECHANICAL DATA

Dimensions in mm

Fig. 1 TO-39.

Collector connected to case.

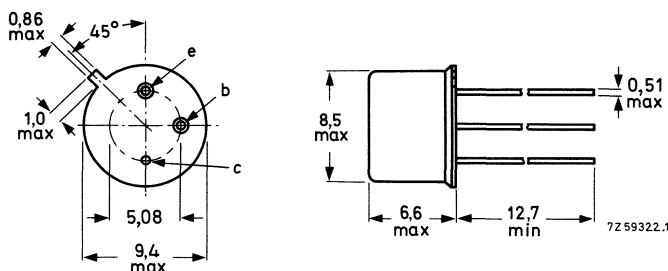

Maximum lead diameter is guaranteed only for 12,7 mm.

**RATINGS**

Limiting values in accordance with the Absolute Maximum System (IEC 134)

Collector-base voltage (open emitter)		$-V_{CBO}$	max.	60 V
Collector-emitter voltage (open base)		$-V_{CEO}$	max.	40 V
$-I_C < 100 \text{ mA}$	<b>2N2905</b>	$-V_{CEO}$	max.	60 V
	<b>2N2905A</b>	$-V_{CEO}$	max.	60 V
Emitter-base voltage (open collector)		$-V_{EBO}$	max.	5 V
Collector current (d.c.)		$-I_C$	max.	600 mA
Total power dissipation				
up to $T_{amb} = 25 \text{ }^\circ\text{C}$		$P_{tot}$	max.	0,6 W
up to $T_{case} = 25 \text{ }^\circ\text{C}$		$P_{tot}$	max.	3,0 W
Storage temperature range		$T_{stg}$		$-65 \text{ to } + 150 \text{ }^\circ\text{C}$
Junction temperature		$T_j$	max.	200 $^\circ\text{C}$

**THERMAL RESISTANCE**

From junction to ambient in free air		$R_{th\ j-a}$	=	292 K/W
From junction to case		$R_{th\ j-c}$	=	58 K/W



**CHARACTERISTICS** $T_{amb} = 25\text{ }^{\circ}\text{C}$  unless otherwise specified

		2N2905	2N2905A
Collector cut-off current			
$I_E = 0; -V_{CB} = 50\text{ V}$	$-I_{CBO}$	< 20	10 nA
$I_E = 0; -V_{CB} = 50\text{ V}; T_{amb} = 150\text{ }^{\circ}\text{C}$	$-I_{CBO}$	< 20	10 $\mu\text{A}$
$+V_{BE} = 0,5\text{ V}; -V_{CE} = 30\text{ V}$	$-I_{CEX}$	< 50	50 nA
Base current			
$+V_{BE} = 0,5\text{ V}; -V_{CE} = 30\text{ V}$	$I_{BEX}$	< 50	50 nA
Collector-base breakdown voltage open emitter; $-I_C = 10\text{ }\mu\text{A}$	$-V_{(BR)CBO}$	> 60	60 V
Collector-emitter breakdown voltage* open base; $-I_C = 10\text{ mA}$	$-V_{(BR)CEO}$	> 40	60 V
Emitter-base breakdown voltage open collector; $-I_E = 10\text{ }\mu\text{A}$	$-V_{(BR)EBO}$	> 5	5 V
Saturation voltages*			
$-I_C = 150\text{ mA}; -I_B = 15\text{ mA}$	$-V_{CEsat}$	< 0,4	0,4 V
	$-V_{BEsat}$	< 1,3	1,3 V
$-I_C = 500\text{ mA}; -I_B = 50\text{ mA}$	$-V_{CEsat}$	< 1,6	1,6 V
	$-V_{BEsat}$	< 2,6	2,6 V
D.C. current gain			
$-I_C = 0,1\text{ mA}; -V_{CE} = 10\text{ V}$	$h_{FE}$	> 35	75
$-I_C = 1\text{ mA}; -V_{CE} = 10\text{ V}$	$h_{FE}$	> 50	100
$-I_C = 10\text{ mA}; -V_{CE} = 10\text{ V}$	$h_{FE}$	> 75	100
$-I_C = 150\text{ mA}; -V_{CE} = 10\text{ V}^*$	$h_{FE}$	> 100	100
	$h_{FE}$	< 300	300
$-I_C = 500\text{ mA}; -V_{CE} = 10\text{ V}^*$	$h_{FE}$	> 30	50
Collector capacitance at $f = 100\text{ kHz}$ $I_E = I_e = 0; -V_{CB} = 10\text{ V}$	$C_C$	< 8	pF
Emitter capacitance at $f = 100\text{ kHz}$ $I_C = I_c = 0; -V_{EB} = 2\text{ V}$	$C_e$	< 30	pF
Transition frequency at $f = 100\text{ MHz}$ $-I_C = 50\text{ mA}; -V_{CE} = 20\text{ V}^*$	$f_T$	> 200	MHz

\* Measured under pulse conditions to avoid excessive dissipation;  $t_p \leq 300\text{ }\mu\text{s}$ ;  $\delta \leq 0,02$ .

Turn-on time (see Fig. 2)

when switched to  $-I_{Con} = 150 \text{ mA}$ ;  $-I_{Bon} = 15 \text{ mA}$   
delay time

rise time

turn-on time

$$t_d < 10 \text{ ns}$$

$$t_r < 40 \text{ ns}$$

$$t_{on} < 45 \text{ ns}$$

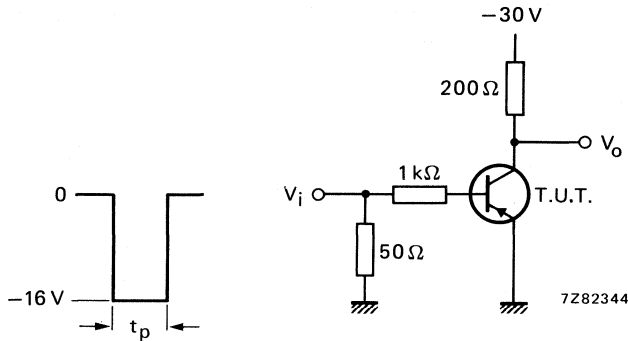

Fig. 2 Input waveform and test circuit for determining delay, rise and turn-on time.

Turn-off time (see Fig. 3)

when switched from  $-I_{Con} = 150 \text{ mA}$ ;  $-I_{Bon} = 15 \text{ mA}$   
to cut-off with  $+I_{Boff} = 15 \text{ mA}$

storage time

turn-off time

$$t_s < 80 \text{ ns}$$

$$t_{off} < 100 \text{ ns}$$

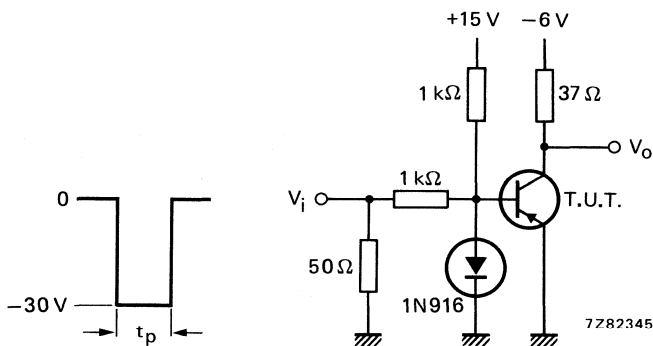

Fig. 3 Input waveform and test circuit for determining storage, fall and turn-off time.

Pulse generator (see Figs 2 and 3)

frequency  $f = 150 \text{ Hz}$

pulse duration  $t_p = 200 \text{ ns}$

rise time  $t_r \leq 2 \text{ ns}$

output impedance  $Z_o = 50 \Omega$

Oscilloscope (see Figs 2 and 3)

rise time  $t_r \leq 5 \text{ ns}$

input impedance  $Z_i = 10 \text{ M}\Omega$

## SILICON PLANAR EPITAXIAL TRANSISTORS



P-N-P medium power transistors in TO-18 metal envelopes designed primarily for high-speed switching and driver applications for industrial service.

### QUICK REFERENCE DATA

Collector-base voltage (open emitter)		$-V_{CBO}$	max.	60 V
Collector-emitter voltage (open base)	2N2906	$-V_{CEO}$	max.	40 V
	2N2906A	$-V_{CEO}$	max.	60 V
Collector current (d.c.)		$-I_C$	max.	600 mA
Total power dissipation up to $T_{amb} = 25\text{ }^\circ\text{C}$		$P_{tot}$	max.	0,4 W
Junction temperature		$T_j$	max.	200 $^\circ\text{C}$
D.C. current gain at $T_j = 25\text{ }^\circ\text{C}$		$h_{FE}$		40 to 120
$-I_C = 150\text{ mA}; -V_{CE} = 10\text{ V}$				
Transition frequency at $f = 100\text{ MHz}$		$f_T$	>	200 MHz
$-I_C = 50\text{ mA}; -V_{CE} = 20\text{ V}; T_j = 25\text{ }^\circ\text{C}$				
Storage time		$t_s$	<	80 ns
$-I_{Con} = 150\text{ mA}; -I_{Bon} = I_{Boff} = 15\text{ mA}$				

### MECHANICAL DATA

Dimensions in mm

Fig. 1 TO-18.

Collector connected to case.

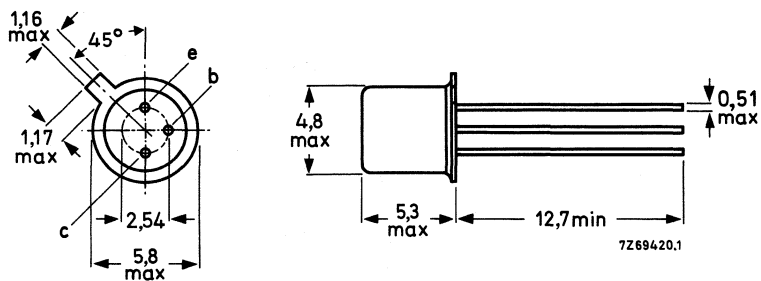

**RATINGS**

Limiting values in accordance with the Absolute Maximum System (IEC 134)

Collector-base voltage (open emitter)		$-V_{CBO}$	max.	60 V
Collector-emitter voltage (open base) $-I_C < 100 \text{ mA}$	<b>2N2906</b>	$-V_{CEO}$	max.	40 V
	<b>2N2906A</b>	$-V_{CEO}$	max.	60 V
Emitter-base voltage (open collector)		$-V_{EBO}$	max.	5 V
Collector current (d.c.)		$-I_C$	max.	600 mA
Total power dissipation up to $T_{amb} = 25 \text{ }^\circ\text{C}$		$P_{tot}$	max.	0,4 W
		$P_{tot}$	max.	1,2 W
Storage temperature range		$T_{stg}$		$-65 \text{ to } +150 \text{ }^\circ\text{C}$
Junction temperature		$T_j$	max.	200 $^\circ\text{C}$

**THERMAL RESISTANCE**

From junction to ambient in free air	$R_{th \text{ j-a}}$	=	438 K/W
From junction to case	$R_{th \text{ j-c}}$	=	146 K/W

## CHARACTERISTICS

 $T_{amb} = 25\text{ }^{\circ}\text{C}$  unless otherwise specified

		2N2906	2N2906A	
Collector cut-off current				
$I_E = 0; -V_{CB} = 50\text{ V}$	$-I_{CBO}$	< 20	10	nA
$I_E = 0; -V_{CB} = 50\text{ V}; T_{amb} = 150\text{ }^{\circ}\text{C}$	$-I_{CBO}$	< 20	10	$\mu\text{A}$
$+V_{BE} = 0,5\text{ V}; -V_{CE} = 30\text{ V}$	$-I_{CEX}$	< 50	50	nA
Base current				
$+V_{BE} = 0,5\text{ V}; -V_{CE} = 30\text{ V}$	$I_{BEX}$	< 50	50	nA
Collector-base breakdown voltage open emitter; $-I_C = 10\text{ }\mu\text{A}$	$-V_{(BR)CBO}$	> 60	60	V
Collector-emitter breakdown voltage* open base; $-I_C = 10\text{ mA}$	$-V_{(BR)CEO}$	> 40	60	V
Emitter-base breakdown voltage open collector; $-I_E = 10\text{ }\mu\text{A}$	$-V_{(BR)EBO}$	> 5	5	V
Saturation voltages*				
$-I_C = 150\text{ mA}; -I_B = 15\text{ mA}$	$-V_{CEsat}$	< 0,4	0,4	V
	$-V_{BEsat}$	< 1,3	1,3	V
$-I_C = 500\text{ mA}; -I_B = 50\text{ mA}$	$-V_{CEsat}$	< 1,6	1,6	V
	$-V_{BEsat}$	< 2,6	2,6	V
D.C. current gain				
$-I_C = 0,1\text{ mA}; -V_{CE} = 10\text{ V}$	$h_{FE}$	> 20	40	
$-I_C = 1\text{ mA}; -V_{CE} = 10\text{ V}$	$h_{FE}$	> 25	40	
$-I_C = 10\text{ mA}; -V_{CE} = 10\text{ V}$	$h_{FE}$	> 35	40	
$-I_C = 150\text{ mA}; -V_{CE} = 10\text{ V}^*$	$h_{FE}$	> 40	40	
	$h_{FE}$	< 120	120	
$-I_C = 500\text{ mA}; -V_{CE} = 10\text{ V}^*$	$h_{FE}$	> 20	40	
Collector capacitance at $f = 100\text{ kHz}$ $I_E = I_e = 0; -V_{CB} = 10\text{ V}$	$C_c$	< 8		pF
Emitter capacitance at $f = 100\text{ kHz}$ $I_C = I_c = 0; -V_{EB} = 2\text{ V}$	$C_e$	< 30		pF
Transition frequency at $f = 100\text{ MHz}$ $-I_C = 50\text{ mA}; -V_{CE} = 20\text{ V}^*$	$f_T$	> 200		MHz

\* Measured under pulse conditions to avoid excessive dissipation:  $t_p \leq 300\text{ }\mu\text{s}; \delta \leq 0,02$ .

Turn-on time (see Fig. 2)

when switched to  $-I_{Con} = 150 \text{ mA}$ ;  $-I_{Bon} = 15 \text{ mA}$

delay time

rise time

turn-on time

$$t_d < 10 \text{ ns}$$

$$t_r < 40 \text{ ns}$$

$$t_{on} < 45 \text{ ns}$$

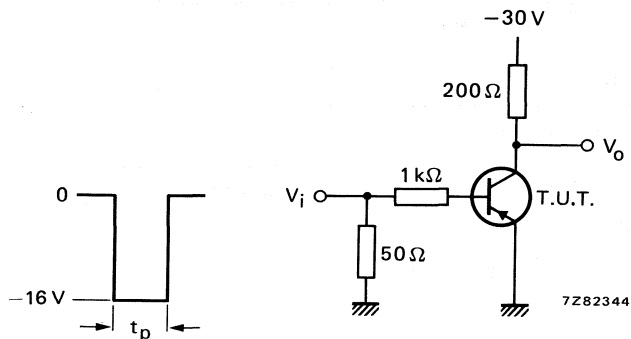

Fig. 2 Input waveform and test circuit for determining delay, rise and turn-on time.

Turn-off time (see Fig. 3)

when switched from  $-I_{Con} = 150 \text{ mA}$ ;  $-I_{Bon} = 15 \text{ mA}$

to cut-off with  $+I_{Boff} = 15 \text{ mA}$

storage time

turn-off time

$$t_s < 80 \text{ ns}$$

$$t_{off} < 100 \text{ ns}$$

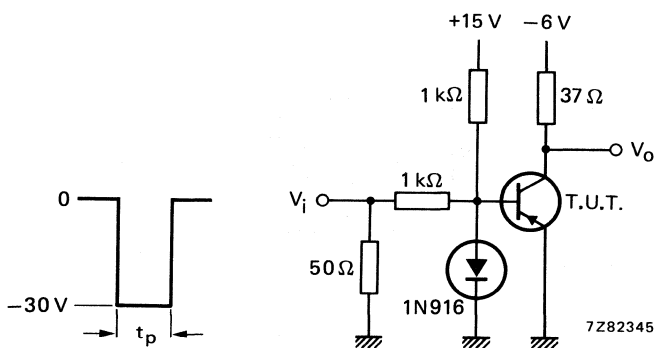

Fig. 3 Input waveform and test circuit for determining storage, fall and turn-off time.

Pulse generator (see Figs 2 and 3)

frequency  $f = 150 \text{ Hz}$

pulse duration  $t_p = 200 \text{ ns}$

rise time  $t_r \leq 2 \text{ ns}$

output impedance  $Z_o = 50 \Omega$

Oscilloscope (see Figs 2 and 3)

rise time  $t_r \leq 5 \text{ ns}$

input impedance  $Z_i \leq 10 \text{ M}\Omega$

## SILICON PLANAR EPITAXIAL TRANSISTORS



P-N-P medium power transistors in TO-18 metal envelopes designed primarily for high-speed switching and driver applications for industrial service.

### QUICK REFERENCE DATA

Collector-base voltage (open emitter)		$-V_{CBO}$	max.	60 V
Collector-emitter voltage (open base)	2N2907	$-V_{CEO}$	max.	40 V
	2N2907A	$-V_{CEO}$	max.	60 V
Collector current (d.c.)		$-I_C$	max.	600 mA
Total power dissipation up to $T_{amb} = 25\text{ }^\circ\text{C}$		$P_{tot}$	max.	0,4 W
Junction temperature		$T_j$	max.	200 $^\circ\text{C}$
D.C. current gain at $T_j = 25\text{ }^\circ\text{C}$		$h_{FE}$		100 to 300
Transition frequency at $f = 100\text{ MHz}$	$-I_C = 150\text{ mA}; -V_{CE} = 10\text{ V}$			
	$-I_C = 50\text{ mA}; -V_{CE} = 20\text{ V}; T_j = 25\text{ }^\circ\text{C}$	$f_T$	>	200 MHz
Storage time		$t_s$	<	80 ns
	$-I_{Con} = 150\text{ mA}; -I_{Bon} = I_{Boff} = 15\text{ mA}$			

### MECHANICAL DATA

Dimensions in mm

Fig. 1 TO-18.

Collector connected to case.

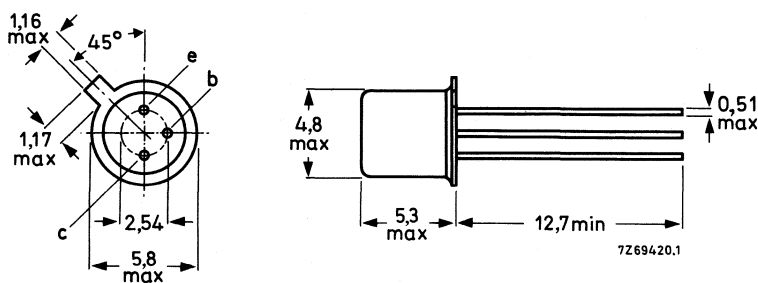

**RATINGS**

Limiting values in accordance with the Absolute Maximum System (IEC 134)

Collector-base voltage (open emitter)		$-V_{CBO}$	max.	60 V
Collector-emitter voltage (open base)				
$-I_C < 100 \text{ mA}$	2N2907	$-V_{CEO}$	max.	40 V
	2N2907A	$-V_{CEO}$	max.	60 V
Emitter-base voltage (open collector)		$-V_{EBO}$	max.	5 V
Collector current (d.c.)		$-I_C$	max.	600 mA
Total power dissipation				
up to $T_{amb} = 25 \text{ }^\circ\text{C}$		$P_{tot}$	max.	0,4 W
up to $T_{case} = 25 \text{ }^\circ\text{C}$		$P_{tot}$	max.	1,2 W
Storage temperature range		$T_{stg}$	-65 to +150	$^\circ\text{C}$
Junction temperature		$T_j$	max.	200 $^\circ\text{C}$

**THERMAL RESISTANCE**

From junction to ambient in free air	$R_{th\ j-a}$	=	438 K/W
From junction to case	$R_{th\ j-c}$	=	146 K/W



**CHARACTERISTICS** $T_{amb} = 25\text{ }^{\circ}\text{C}$  unless otherwise specified

Collector cut-off current

$I_E = 0; -V_{CB} = 50\text{ V}$

	2N2907	2N2907A
$-I_{CBO}$	< 20	10 nA
$-I_{CBO}$	< 20	10 $\mu\text{A}$
$-I_{CEX}$	< 50	50 nA

$I_E = 0; -V_{CB} = 50\text{ V}; T_{amb} = 150\text{ }^{\circ}\text{C}$

$+V_{BE} = 0,5\text{ V}; -V_{CE} = 30\text{ V}$

Base current

$+V_{BE} = 0,5\text{ V}; -V_{CE} = 30\text{ V}$

$I_{BEX}$	< 50	50 nA
-----------	------	-------

Collector-base breakdown voltage

open emitter;  $-I_C = 10\text{ }\mu\text{A}$

$-V_{(BR)CBO}$	> 60	60 V
----------------	------	------

Collector-emitter breakdown voltage \*

open base;  $-I_C = 10\text{ mA}$

$-V_{(BR)CEO}$	> 40	60 V
----------------	------	------

Emitter-base breakdown voltage

open collector;  $-I_E = 10\text{ }\mu\text{A}$

$-V_{(BR)EBO}$	> 5	5 V
----------------	-----	-----

Saturation voltages \*

$-I_C = 150\text{ mA}; -I_B = 15\text{ mA}$

$-V_{CEsat}$	< 0,4	0,4 V
--------------	-------	-------

$-V_{BEsat}$	< 1,3	1,3 V
--------------	-------	-------

$-I_C = 500\text{ mA}; -I_B = 50\text{ mA}$

$-V_{CEsat}$	< 1,6	1,6 V
--------------	-------	-------

$-V_{BEsat}$	< 2,6	2,6 V
--------------	-------	-------

D.C. current gain

$-I_C = 0,1\text{ mA}; -V_{CE} = 10\text{ V}$

$h_{FE}$	> 35	75
----------	------	----

$-I_C = 1\text{ mA}; -V_{CE} = 10\text{ V}$

$h_{FE}$	> 50	100
----------	------	-----

$-I_C = 10\text{ mA}; -V_{CE} = 10\text{ V}$

$h_{FE}$	> 75	100
----------	------	-----

$-I_C = 150\text{ mA}; -V_{CE} = 10\text{ V} *$

$h_{FE}$	> 100	100
----------	-------	-----

$h_{FE}$	< 300	300
----------	-------	-----

$-I_C = 500\text{ mA}; -V_{CE} = 10\text{ V} *$

$h_{FE}$	> 30	50
----------	------	----

Collector capacitance at  $f = 100\text{ kHz}$ 

$I_E = I_e = 0; -V_{CB} = 10\text{ V}$

$C_c$	< 8	pF
-------	-----	----

Emitter capacitance at  $f = 100\text{ kHz}$ 

$I_C = I_c = 0; -V_{EB} = 2\text{ V}$

$C_e$	< 30	pF
-------	------	----

Transition frequency at  $f = 100\text{ MHz}$ 

$-I_C = 50\text{ mA}; -V_{CE} = 20\text{ V} *$

$f_T$	> 200	MHz
-------	-------	-----

\* Measured under pulse conditions to avoid excessive dissipation:  $t_p \leq 300\text{ }\mu\text{s}; \delta \leq 0,02$ .

# 2N2907 2N2907A

Turn-on time (see Fig. 2)

when switched to  $-I_{Con} = 150 \text{ mA}$ ;  $-I_{Bon} = 15 \text{ mA}$

delay time

rise time

turn-on time

$$t_d < 10 \text{ ns}$$

$$t_r < 40 \text{ ns}$$

$$t_{on} < 45 \text{ ns}$$

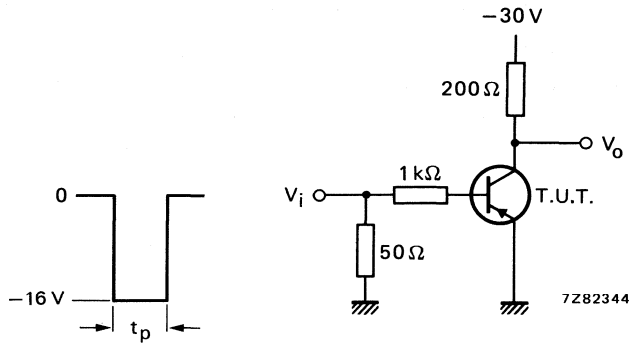

Fig. 2 Input waveform and test circuit for determining delay, rise and turn-on time.

Turn-off time (see Fig. 3)

when switched from  $-I_{Con} = 150 \text{ mA}$ ;  $-I_{Bon} = 15 \text{ mA}$

to cut-off with  $+I_{Boff} = 15 \text{ mA}$

storage time

turn-off time

$$t_s < 80 \text{ ns}$$

$$t_{off} < 100 \text{ ns}$$

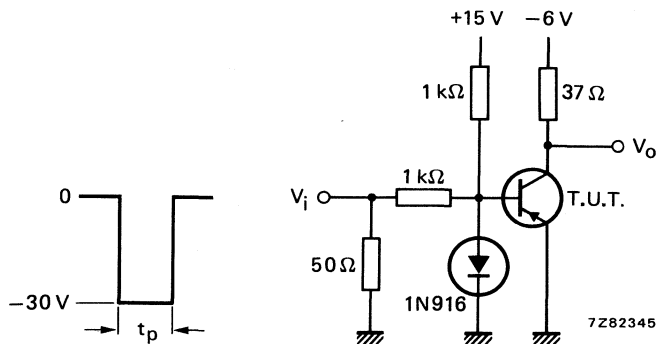

Fig. 3 Input waveform and test circuit for determining storage, fall and turn-off time.

Pulse generator (see Figs 2 and 3)

frequency  $f = 150 \text{ Hz}$

pulse duration  $t_p = 200 \text{ ns}$

rise time  $t_r \leq 2 \text{ ns}$

output impedance  $Z_o = 50 \Omega$

Oscilloscope (see Figs 2 and 3)

rise time  $t_r \leq 5 \text{ ns}$

input impedance  $Z_i \leq 10 \text{ M}\Omega$

## SILICON PLANAR EPITAXIAL TRANSISTORS



N-P-N transistors in TO-39 metal envelopes intended for use as amplifiers and in switching circuits.

### QUICK REFERENCE DATA

Collector-base voltage (open emitter)	$V_{CB0}$	max.	140	V
Collector-emitter voltage (open base)	$V_{CE0}$	max.	80	V
Collector current (d.c.)	$I_C$	max.	1	A
Total power dissipation up to $T_{amb} = 25\text{ }^\circ\text{C}$ up to $T_{case} = 25\text{ }^\circ\text{C}$	$P_{tot}$	max.	0,8	W
	$P_{tot}$	max.	5,0	W
Junction temperature	$T_j$	max.	200	$^\circ\text{C}$
D.C. current gain $I_C = 150\text{ mA}; V_{CE} = 10\text{ V}$	$h_{FE}$	$>$	100	40
		$<$	300	120
Transition frequency at $f = 20\text{ MHz}$ $I_C = 50\text{ mA}; V_{CE} = 10\text{ V}$	$f_T$	$>$	100	80

### MECHANICAL DATA

Dimensions in mm

Fig. 1 TO-39.

Collector connected to case

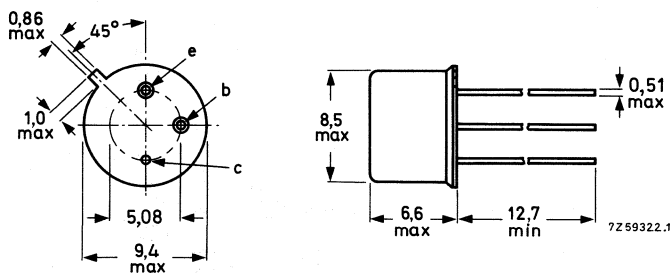

Maximum lead diameter is guaranteed only for 12,7 mm.

### RATINGS

Limiting values in accordance with the Absolute Maximum System (IEC 134)

Collector-base voltage (open emitter)	$V_{CB0}$	max.	140 V
Collector-emitter voltage (open base)	$V_{CEO}$	max.	80 V
Emitter-base voltage (open collector)	$V_{EBO}$	max.	7 V
Collector current (d.c.)	$I_C$	max.	1 A
Total power dissipation up to $T_{amb} = 25\text{ }^\circ\text{C}$ up to $T_{case} = 25\text{ }^\circ\text{C}$	$P_{tot}$	max.	0,8 W
	$P_{tot}$	max.	5,0 W
Storage temperature range	$T_{stg}$		-65 to +150 $^\circ\text{C}$
Junction temperature	$T_j$	max.	200 $^\circ\text{C}$

### THERMAL RESISTANCE

From junction to ambient in free air	$R_{th\ j-a}$	=	218 K/W
From junction to case	$R_{th\ j-c}$	=	35 K/W

### CHARACTERISTICS

$T_{amb} = 25\text{ }^\circ\text{C}$  unless otherwise specified

Collector cut-off current

$$I_E = 0; V_{CB} = 90\text{ V} \quad I_{CBO} < 10\text{ nA}$$

$$I_E = 0; V_{CB} = 90\text{ V}; T_{amb} = 150\text{ }^\circ\text{C} \quad I_{CBO} < 10\text{ }\mu\text{A}$$

Emitter cut-off current

$$I_C = 0; V_{EB} = 5\text{ V} \quad I_{EBO} < 10\text{ nA}$$

Breakdown voltages

$$I_E = 0; I_C = 100\text{ }\mu\text{A} \quad V_{(BR)CBO} > 140\text{ V}$$

$$I_B = 0; I_C = 30\text{ mA} \quad V_{(BR)CEO} > 80\text{ V}^*$$

$$I_C = 0; I_E = 100\text{ }\mu\text{A} \quad V_{(BR)EBO} > 7\text{ V}$$

Saturation voltages

$$I_C = 150\text{ mA}; I_B = 15\text{ mA} \quad V_{CEsat} < 0,2\text{ V}$$

$$I_C = 150\text{ mA}; I_B = 15\text{ mA} \quad V_{BEsat} < 1,1\text{ V}^*$$

$$I_C = 500\text{ mA}; I_B = 50\text{ mA} \quad V_{CEsat} < 0,5\text{ V}^*$$

\* Measured under pulse conditions:  $t_p = 300\text{ }\mu\text{s}$ ;  $\delta \leq 0,01$ .

			2N3019	2N3020
D.C. current gain *				
$I_C = 0,1 \text{ mA}; V_{CE} = 10 \text{ V}$	$h_{FE}$	$>$	50	30
		$<$	—	100
$I_C = 10 \text{ mA}; V_{CE} = 10 \text{ V}$	$h_{FE}$	$>$	90	40
		$<$	—	120
$I_C = 150 \text{ mA}; V_{CE} = 10 \text{ V}$	$h_{FE}$	$>$	100	40
		$<$	300	120
$I_C = 150 \text{ mA}; V_{CE} = 10 \text{ V}; T_{\text{case}} = -55 \text{ }^\circ\text{C}$	$h_{FE}$	$>$	40	—
$I_C = 500 \text{ mA}; V_{CE} = 10 \text{ V}$	$h_{FE}$	$>$	50	30
		$<$	—	100
$I_C = 1000 \text{ mA}; V_{CE} = 10 \text{ V}$	$h_{FE}$	$>$	15	15
Transition frequency at $f = 20 \text{ MHz}$				
$I_C = 50 \text{ mA}; V_{CE} = 10 \text{ V}$	$f_T$	$>$	100	80 MHz
Collector capacitance at $f = 1 \text{ MHz}$				
$I_E = I_C = 0; V_{CB} = 10 \text{ V}$	$C_c$	$<$	12	12 pF
Emitter capacitance at $f = 1 \text{ MHz}$				
$I_C = I_E = 0; V_{EB} = 0,5 \text{ V}$	$C_e$	$<$	60	60 pF
Feedback time constant at $f = 4 \text{ MHz}$				
$I_C = 10 \text{ mA}; V_{CB} = 10 \text{ V}$	$r_{bb}'C_{b'c}$	$<$	400	400 ps
Small-signal current gain at $f = 1 \text{ kHz}$				
$I_C = 1,0 \text{ mA}; V_{CE} = 5 \text{ V}$	$h_{fe}$	$>$	80	30
		$<$	400	200
Noise figure at $f = 1 \text{ kHz}$				
$I_C = 0,1 \text{ mA}; V_{CE} = 10 \text{ V}; R_S = 1 \text{ k}\Omega$	F	$<$	4	— dB

\* Measured under pulse conditions:  $t_p = 300 \mu\text{s}; \delta \leq 0,01$ .



## SILICON PLANAR TRANSISTOR

N-P-N transistor in a TO-39 metal envelope designed for medium speed, saturated and non-saturated switching applications for industrial service.

### QUICK REFERENCE DATA

Collector-base voltage (open emitter)	$V_{CB0}$	max.	60 V
Collector-emitter voltage (open base)	$V_{CEO}$	max.	40 V
Collector current (d.c.)	$I_C$	max.	700 mA
Total power dissipation up to $T_{case} = 25\text{ }^\circ\text{C}$	$P_{tot}$	max.	5,0 W
Junction temperature	$T_j$	max.	200 $^\circ\text{C}$
D.C. current gain $I_C = 150\text{ mA}; V_{CE} = 10\text{ V}$	$h_{FE}$		50 to 250
Transition frequency at $f = 20\text{ MHz}$ $I_C = 50\text{ mA}; V_{CE} = 10\text{ V}$	$f_T$	>	100 MHz

### MECHANICAL DATA

Dimensions in mm

Fig. 1 TO-39.

Collector connected to case

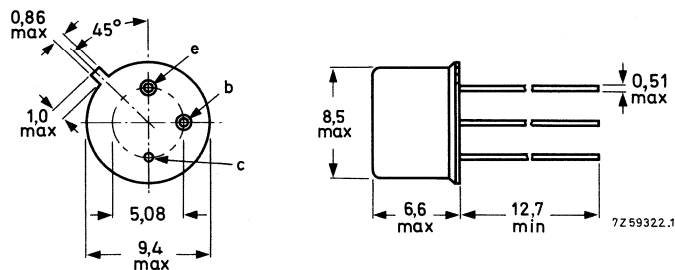

Maximum lead diameter is guaranteed only for 12,7 mm.

**RATINGS**

Limiting values in accordance with the Absolute Maximum System (IEC 134)

Collector-base voltage (open emitter)	$V_{CBO}$	max.	60 V
Collector-emitter voltage (open base)*	$V_{CEO}$	max.	40 V
Emitter-base voltage (open collector)	$V_{EBO}$	max.	5 V
Collector current (d.c.)	$I_C$	max.	700 mA
Total power dissipation up to $T_{case} = 25\text{ }^\circ\text{C}$	$P_{tot}$	max.	5,0 W
Storage temperature range	$T_{stg}$		-65 to + 150 $^\circ\text{C}$
Junction temperature	$T_j$	max.	200 $^\circ\text{C}$

**THERMAL RESISTANCE**

From junction to case	$R_{th\ j-c}$	=	35 K/W
-----------------------	---------------	---	--------

**CHARACTERISTICS** $T_{amb} = 25\text{ }^\circ\text{C}$ 

Collector cut-off current

 $V_{CE} = 30\text{ V}; -V_{BE} = 1,5\text{ V}$ 

$I_{CEX}$	<	0,25 $\mu\text{A}$
-----------	---	--------------------

Emitter cut-off current

 $I_C = 0; V_{EB} = 4\text{ V}$ 

$I_{EBO}$	<	0,25 $\mu\text{A}$
-----------	---	--------------------

Collector-base breakdown voltage

open emitter;  $I_C = 100\text{ }\mu\text{A}$ 

$V_{(BR)CBO}$	>	60 V
---------------	---	------

Collector-emitter breakdown voltage\*\*

open emitter;  $I_C = 100\text{ }\mu\text{A}$ 

$V_{(BR)CEO}$	>	40 V
---------------	---	------

 $I_C = 100\text{ mA}; R_{BE} = 10\text{ }\Omega$ 

$V_{(BR)CER}$	>	50 V
---------------	---	------

Emitter-base breakdown voltage

open collector;  $I_E = 100\text{ }\mu\text{A}$ 

$V_{(BR)EBO}$	>	5 V
---------------	---	-----

Base-emitter voltage

 $I_C = 150\text{ mA}; V_{CE} = 2,5\text{ V}$ 

$V_{BE}$	<	1,7 V
----------	---	-------

Saturation voltages

 $I_C = 150\text{ mA}; I_B = 15\text{ mA}$ 

$V_{CEsat}$	<	1,4 V
-------------	---	-------

$V_{BEsat}$	<	1,7 V
-------------	---	-------

D.C. current gain

 $I_C = 150\text{ mA}; V_{CE} = 2,5\text{ V}$  $I_C = 150\text{ mA}; V_{CE} = 10\text{ V}^{**}$ 

$h_{FE}$	>	25
----------	---	----

$h_{FE}$		50 to 250
----------	--	-----------

Collector capacitance at  $f = 140\text{ kHz}$  $I_E = I_e = 0; V_{CB} = 10\text{ V}$ 

$C_c$	<	15 pF
-------	---	-------

Emitter capacitance at  $f = 140\text{ kHz}$  $I_C = I_c = 0; V_{EB} = 0,5\text{ V}$ 

$C_e$	<	80 pF
-------	---	-------

Transition frequency at  $f = 20\text{ MHz}$  $I_C = 50\text{ mA}; V_{CE} = 10\text{ V}$ 

$f_T$	>	100 MHz
-------	---	---------

\* For  $I_C = 0$  to 100 mA (pulse conditions):  $t_p = 300\text{ }\mu\text{s}$ ;  $\delta = 0,018$ , 0 to 700 mA for shorter pulses.\*\* Measured under pulse conditions to avoid excessive dissipation:  $t_p = 300\text{ }\mu\text{s}$ ;  $\delta = 0,018$ .



## SILICON NPN HIGH-VOLTAGE TRANSISTORS

NPN high-voltage small-signal transistors in a TO-39 envelope and intended for use in telephony and professional communication equipment.

Complementary type is 2N5415/5416.

### QUICK REFERENCE DATA

			2N3439	2N3440
Collector-base voltage (open emitter)	$V_{CBO}$	max.	400	300 V
Collector-emitter voltage (open base)	$V_{CEO}$	max.	350	250 V
Collector current (DC)	$I_C$	max.	1.0	1.0 A
Total power dissipation up to $T_{amb} = 25\text{ }^\circ\text{C}$	$P_{tot}$	max.	1	1 W
Junction temperature	$T_j$	max.	200	200 $^\circ\text{C}$
Collector-emitter saturation voltage $I_C = 50\text{ mA}; I_B = 4\text{ mA}$	$V_{CEsat}$	max.	0.5	0.5 V
DC current gain $I_C = 2\text{ mA}; V_{CE} = 10\text{ V}$ $I_C = 20\text{ mA}; V_{CE} = 10\text{ V}$	$h_{FE}$	min.	30	40

### MECHANICAL DATA

Dimensions in mm

Fig.1 TO-39.

Collector connected to case

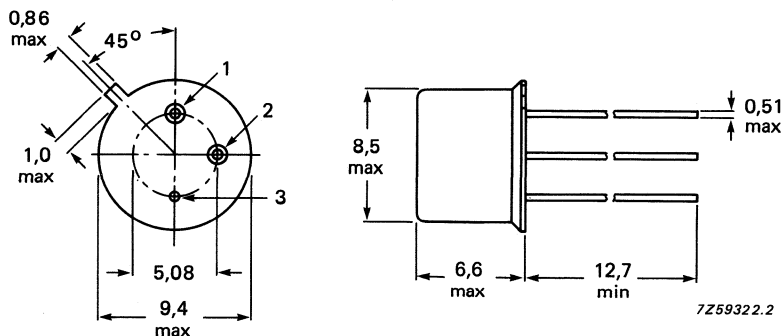

Maximum lead diameter is guaranteed only for 12.7 mm.

### RATINGS

Limiting values in accordance with the Absolute Maximum System (IEC 134)

			2N3439	2N3440
Collector-base voltage (open emitter)	$V_{CBO}$	max.	400	300 V
Collector-emitter voltage (open base)	$V_{CEO}$	max.	350	250 V
Emitter-base voltage (open collector)	$V_{EBO}$	max.	5.0	V
Collector current (DC)	$I_C$	max.	1.0	A
Base current	$I_B$	max.	0.5	A
Total power dissipation up to $T_{amb} = 25\text{ }^\circ\text{C}$ $T_{case} = 25\text{ }^\circ\text{C}$	$P_{tot}$	max.	1	W
	$P_{tot}$	max.	10	W
Junction temperature	$T_j$	max.	200	$^\circ\text{C}$
Storage temperature range	$T_j$		-65 to 150	$^\circ\text{C}$

### THERMAL RESISTANCE

From junction to ambient in free air	$R_{thj-a}$	=	219	K/W
From junction to case	$R_{thj-c}$	=	58.3	K/W

### CHARACTERISTICS

$T_j = 25\text{ }^\circ\text{C}$  unless otherwise specified

			2N3439	2N3440
Collector cut-off currents				
$I_E = 0; V_{CB} = 360\text{ V}$	$I_{CBO}$	max.	0.1	$\mu\text{A}$
$I_E = 0; V_{CB} = 250\text{ V}$		max.		0.1 $\mu\text{A}$
$I_B = 0; V_{CE} = 300\text{ V}$	$I_{CEO}$	max.	1.0	$\mu\text{A}$
$I_B = 0; V_{CE} = 200\text{ V}$		max.		1.0 $\mu\text{A}$
Emitter cut-off current				
$I_C = 0; V_{EB} = 5\text{ V}$	$I_{EBO}$	max.	10	10 $\mu\text{A}$
Collector-emitter sustaining voltage				
$I_B = 0; I_C = 50\text{ mA}$	$V_{CEO_{sus}}$	min.	350	250 V
Saturation voltages				
$I_C = 50\text{ mA}; I_B = 4\text{ mA}$	$V_{CE_{sat}}$	max.	0.5	0.5 V
	$V_{BE_{sat}}$	max.	1.3	1.3 V
DC current gain				
$I_C = 2\text{ mA}; V_{CE} = 10\text{ V}$	$h_{FE}$	min.	30	
$I_C = 20\text{ mA}; V_{CE} = 10\text{ V}$		min.		40
Transition frequency at $f = 5\text{ MHz}$				
$I_C = 10\text{ mA}; V_{CE} = 10\text{ V}; T_{amb} = 25\text{ }^\circ\text{C}$	$f_T$	min.	70	MHz
Small-signal current gain at $f = 1\text{ kHz}$				
$I_C = 5\text{ mA}; V_{CE} = 10\text{ V}; T_{amb} = 25\text{ }^\circ\text{C}$	$h_{fe}$	min.	25	
Real part (Re) of input impedance ( $h_{ie}$ )				
$V_{CE} = 10\text{ V}; I_C = 5\text{ mA}; f = 1\text{ MHz}; T_{amb} = 25\text{ }^\circ\text{C}$	$\text{Re}(h_{ie})$	max.	300	$\Omega$
Input capacitance at $f = 1\text{ MHz}$				
$I_C = 0; V_{EB} = 5\text{ V}; T_{amb} = 25\text{ }^\circ\text{C}$	$C_e$	max.	20	pF
Output capacitance at $f = 1\text{ MHz}$				
$I_E = 0; V_{CB} = 10\text{ V}; T_{amb} = 25\text{ }^\circ\text{C}$	$C_c$	max.	2.0	pF



## SILICON PLANAR EPITAXIAL TRANSISTOR

NPN transistor in a plastic TO-92 envelope, primarily intended for high-speed, saturated switching applications for industrial service.

PNP complement is 2N3906.

### QUICK REFERENCE DATA

Collector-base voltage (open emitter)	$V_{CBO}$	max.	60 V
Collector-emitter voltage (open base)	$V_{CEO}$	max.	40 V
Collector current (DC)	$I_C$	max.	200 mA
Total power dissipation at $T_{amb} = 25\text{ }^\circ\text{C}$	$P_{tot}$	max.	350 mW
Junction temperature	$T_j$	max.	150 $^\circ\text{C}$
DC current gain	$h_{FE}$	min.	100
$I_C = 10\text{ mA}; V_{CE} = 1\text{ V}$		max.	300
Transition frequency at $f = 100\text{ MHz}$	$f_T$	min.	300 MHz
$I_C = 10\text{ mA}; V_{CE} = 20\text{ V}$			
Storage time	$t_s$	max.	200 ns
$I_{Con} = 10\text{ mA}; I_{Bon} = -I_{Boff} = 1\text{ mA}$			

### MECHANICAL DATA

Dimensions in mm

Fig.1 TO-92.

#### Pinning

- 1 = collector
- 2 = base
- 3 = emitter

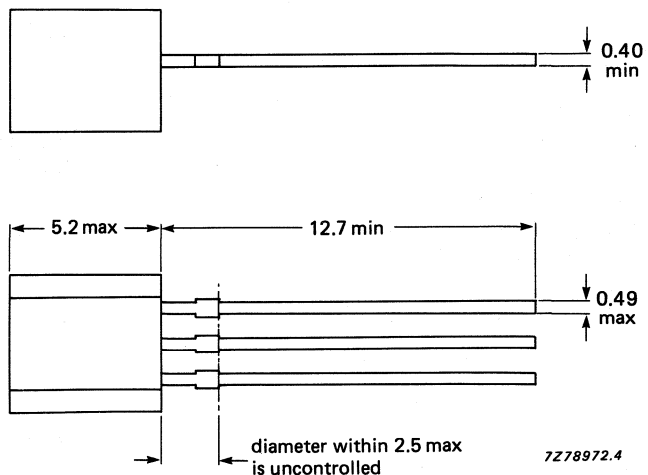
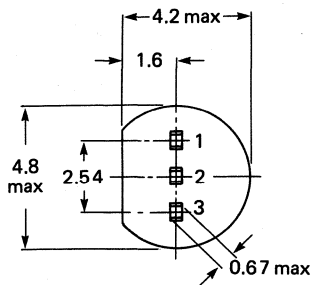
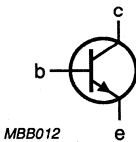

**RATINGS**

Limiting values in accordance with the Absolute Maximum System (IEC 134)

Collector-base voltage (open emitter)	$V_{CBO}$	max.	60 V
Collector-emitter voltage (open base)	$V_{CEO}$	max.	40 V
Emitter-base voltage (open collector)	$V_{EBO}$	max.	6 V
Collector current (DC)	$I_C$	max.	200 mA
Total power dissipation at $T_{amb} = 25\text{ }^\circ\text{C}$	$P_{tot}$	max.	350 mW
Storage temperature range	$T_{stg}$		-65 to + 150 $^\circ\text{C}$
Junction temperature	$T_j$	max.	150 $^\circ\text{C}$

**THERMAL RESISTANCE**

From junction to ambient in free air	$R_{th\ j-a}$	=	357 K/W
--------------------------------------	---------------	---	---------

**CHARACTERISTICS** $T_{amb} = 25\text{ }^\circ\text{C}$ 

Currents at reverse biased emitter junction

 $V_{CE} = 30\text{ V}; -V_{BE} = 3\text{ V}$ 

$I_{CEX}$	max.	50 nA
$-I_{BEX}$	max.	50 nA

Saturation voltages \*

 $I_C = 10\text{ mA}; I_B = 1\text{ mA}$ 

$V_{CEsat}$	max.	200 mV
$V_{BEsat}$		650 to 850 mV

 $I_C = 50\text{ mA}; I_B = 5\text{ mA}$ 

$V_{CEsat}$	max.	300 mV
$V_{BEsat}$	max.	950 mV

DC current gain\*

 $I_C = 0.1\text{ mA}; V_{CE} = 1\text{ V}$ 

$h_{FE}$	min.	40
----------	------	----

 $I_C = 1\text{ mA}; V_{CE} = 1\text{ V}$ 

$h_{FE}$	min.	70
----------	------	----

 $I_C = 10\text{ mA}; V_{CE} = 1\text{ V}$ 

$h_{FE}$	min.	100
	max.	300

 $I_C = 50\text{ mA}; V_{CE} = 1\text{ V}$ 

$h_{FE}$	min.	60
----------	------	----

 $I_C = 100\text{ mA}; V_{CE} = 1\text{ V}$ 

$h_{FE}$	min.	30
----------	------	----

Collector capacitance at  $100\text{ kHz} \leq f \leq 1\text{ MHz}$  $I_E = I_e = 0; V_{CB} = 5\text{ V}$ 

$C_c$	max.	4 pF
-------	------	------

Emitter capacitance at  $100\text{ kHz} \leq f \leq 1\text{ MHz}$  $I_C = I_c = 0; V_{EB} = 0.5\text{ V}$ 

$C_e$	max.	8 pF
-------	------	------

Transition frequency at  $f = 100\text{ MHz}$  $I_C = 10\text{ mA}; V_{CE} = 20\text{ V}$ 

$f_T$	min.	300 MHz
-------	------	---------

Noise figure at  $R_S = 1\text{ k}\Omega$  $I_C = 100\text{ }\mu\text{A}; V_{CE} = 5\text{ V}$  $f = 10\text{ Hz to } 15.7\text{ kHz}$ 

F	max.	5 dB
---	------	------

\* Measured under pulse conditions:  $t_p = 300\text{ }\mu\text{s}; \delta = 0.02$ .

**Switching times**

Turn-on time (see Figs 2 and 3) when switched from  $-V_{BEoff} = 0.5\text{ V}$  to  $I_{Con} = 10\text{ mA}$ ;  $I_{Bon} = 1\text{ mA}$

Delay time  
Rise time

$t_d$	max.	35 ns
$t_r$	max.	35 ns

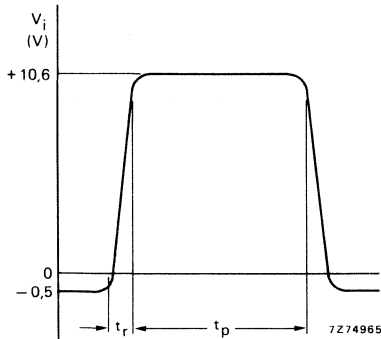

Fig. 2 Input waveform;  $t_r < 1\text{ ns}$ ;  $t_p = 300\text{ ns}$ ;  $\delta = 0.02$ .

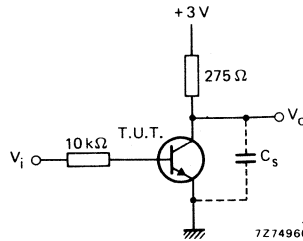

Fig. 3 Delay and rise time test circuit; total shunt capacitance of test jig and connectors  $C_s < 4\text{ pF}$ ; scope impedance =  $10\text{ M}\Omega$ .

Turn-off time (see Figs 4 and 5)

$I_{Con} = 10\text{ mA}$ ;  $I_{Bon} = -I_{Boff} = 1\text{ mA}$

Storage time  
Fall time

$t_s$	max.	200 ns
$t_f$	max.	50 ns

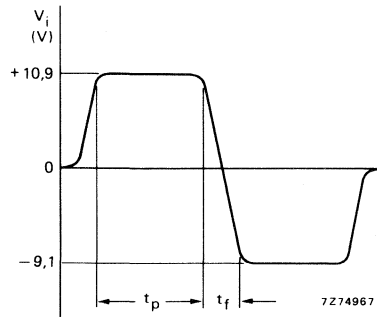

Fig. 4 Input waveform;  $t_f < 1\text{ ns}$ ;  $10\text{ }\mu\text{s} < t_p < 500\text{ }\mu\text{s}$ ;  $\delta = 0.02$ .

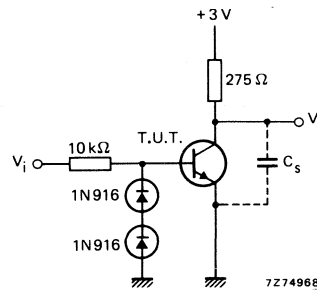

Fig. 5 Storage and fall time test circuit; total shunt capacitance of test jig and connectors  $C_s < 4\text{ pF}$ ; scope impedance =  $10\text{ M}\Omega$ .





## SILICON PLANAR EPITAXIAL TRANSISTOR

PNP transistor in a plastic TO-92 envelope, primarily intended for high-speed, saturated switching applications for industrial service.

NPN complement is 2N3904.

### QUICK REFERENCE DATA

Collector-base voltage (open emitter)	$-V_{CBO}$	max.	40 V
Collector-emitter voltage (open base)	$-V_{CEO}$	max.	40 V
Collector current (DC)	$-I_C$	max.	200 mA
Total power dissipation at $T_{amb} = 25\text{ }^\circ\text{C}$	$P_{tot}$	max.	350 mW
Junction temperature	$T_j$	max.	150 $^\circ\text{C}$
DC current gain	$h_{FE}$	min.	100
$-I_C = 10\text{ mA}; -V_{CE} = 1\text{ V}$		max.	300
Transition frequency at $f = 100\text{ MHz}$	$f_T$	min.	250 MHz
$-I_C = 10\text{ mA}; -V_{CE} = 20\text{ V}$			
Storage time	$t_s$	max.	225 ns
$-I_{Con} = 10\text{ mA}; -I_{Bon} = I_{Boff} = 1\text{ mA}$			

### MECHANICAL DATA

Dimensions in mm

Fig.1 TO-92.

#### Pinning

- 1 = collector
- 2 = base
- 3 = emitter

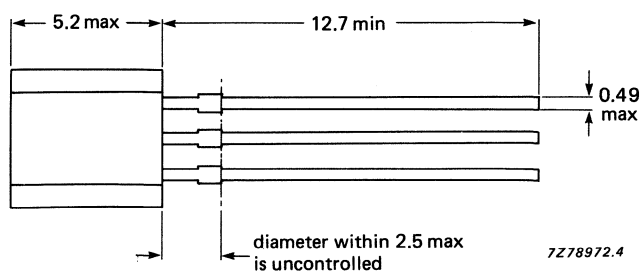
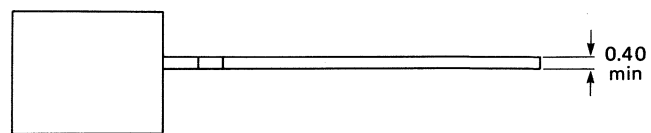
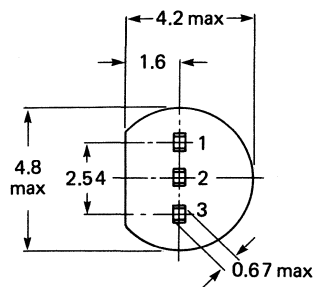
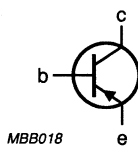

**RATINGS**

Limiting values in accordance with the Absolute Maximum System (IEC 134)

Collector-base voltage (open emitter)	$-V_{CBO}$	max.	40 V
Collector-emitter voltage (open base)	$-V_{CEO}$	max.	40 V
Emitter-base voltage (open collector)	$-V_{EBO}$	max.	5 V
Collector current (DC)	$-I_C$	max.	200 mA
Total power dissipation at $T_{amb} = 25\text{ }^\circ\text{C}$	$P_{tot}$	max.	350 mW
Storage temperature range	$T_{stg}$		-65 to + 150 $^\circ\text{C}$
Junction temperature	$T_j$	max.	150 $^\circ\text{C}$

**THERMAL RESISTANCE**

From junction to ambient in free air	$R_{th\ j-a}$	=	357 K/W
--------------------------------------	---------------	---	---------

**CHARACTERISTICS** $T_{amb} = 25\text{ }^\circ\text{C}$ 

Currents at reverse biased emitter junction

$-V_{CE} = 30\text{ V}; +V_{BE} = 3\text{ V}$	$-I_{CEX}$	max.	50 nA
	$+I_{BEX}$	max.	50 nA

Saturation voltages \*

$-I_C = 10\text{ mA}; -I_B = 1\text{ mA}$	$-V_{CEsat}$	max.	250 mV
	$-V_{BEsat}$		650 to 850 mV
$-I_C = 50\text{ mA}; -I_B = 5\text{ mA}$	$-V_{CEsat}$	max.	400 mV
	$-V_{BEsat}$	max.	950 mV

DC current gain\*

$-I_C = 0.1\text{ mA}; V_{CE} = 1\text{ V}$	$h_{FE}$	min.	60
$-I_C = 1\text{ mA}; V_{CE} = 1\text{ V}$	$h_{FE}$	min.	80
$-I_C = 10\text{ mA}; V_{CE} = 1\text{ V}$	$h_{FE}$	min.	100
		max.	300
$-I_C = 50\text{ mA}; V_{CE} = 1\text{ V}$	$h_{FE}$	min.	60
$-I_C = 100\text{ mA}; V_{CE} = 1\text{ V}$	$h_{FE}$	min.	30

Collector capacitance at  $100\text{ kHz} \leq f \leq 1\text{ MHz}$ 

$I_E = I_e = 0; -V_{CB} = 5\text{ V}$	$C_c$	max.	4.5 pF
---------------------------------------	-------	------	--------

Emitter capacitance at  $100\text{ kHz} \leq f \leq 1\text{ MHz}$ 

$I_C = I_c = 0; -V_{EB} = 0.5\text{ V}$	$C_e$	max.	10 pF
---	-------	------	-------

Transition frequency at  $f = 100\text{ MHz}$ 

$-I_C = 10\text{ mA}; -V_{CE} = 20\text{ V}$	$f_T$	min.	250 MHz
--	-------	------	---------

Noise figure at  $R_S = 1\text{ k}\Omega$ 

$-I_C = 100\text{ }\mu\text{A}; -V_{CE} = 5\text{ V}$ $f = 10\text{ Hz to }15.7\text{ kHz}$	F	max.	4 dB
--	---	------	------

\* Measured under pulse conditions:  $t_p = 300\text{ }\mu\text{s}; \delta = 0.02$ .



**Switching times**

Turn-on time (see Figs 2 and 3) when switched from  
 $+V_{BEoff} = 0.5 \text{ V}$  to  $-I_{Con} = 10 \text{ mA}$ ;  $-I_{Bon} = 1 \text{ mA}$

Delay time  
 Rise time

$t_d$	max.	35 ns
$t_r$	max.	35 ns

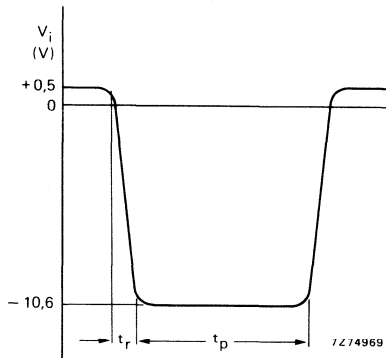

Fig. 2 Input waveform;  $t_r < 1 \text{ ns}$ ;  $t_p = 300 \text{ ns}$ ;  $\delta = 0.02$ .

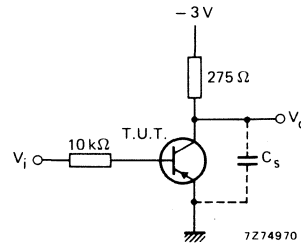

Fig. 3 Delay and rise time test circuit; total shunt capacitance of test jig and connectors  $C_s < 4 \text{ pF}$ ; scope impedance =  $10 \text{ M}\Omega$ .

Turn-off time (see Figs 4 and 5)

$-I_{Con} = 10 \text{ mA}$ ;  $-I_{Bon} = I_{Boff} = 1 \text{ mA}$

Storage time  
 Fall time

$t_s$	max.	225 ns
$t_f$	max.	75 ns

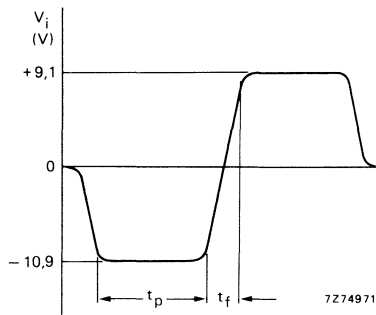

Fig. 4 Input waveform;  $t_f < 1 \text{ ns}$ ;  $10 \mu\text{s} < t_p < 500 \mu\text{s}$ ;  $\delta = 0.02$ .

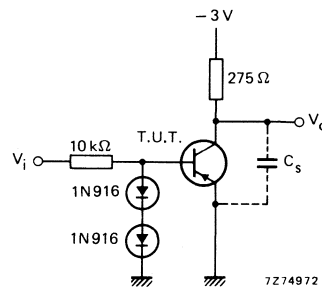

Fig. 5 Storage and fall time test circuit; total shunt capacitance of test jig and connectors  $C_s < 4 \text{ pF}$ ; scope impedance =  $10 \text{ M}\Omega$ .





## SILICON PLANAR EPITAXIAL TRANSISTORS

P-N-P transistors in TO-39 metal envelopes primarily intended for large signal, low-noise, low-power audio frequency applications for industrial service.

### QUICK REFERENCE DATA

		2N4030 2N4032	2N4031 2N4033	
Collector-base voltage (open emitter)	$-V_{CBO}$ max.	60	80	V
Collector-emitter voltage (open base)	$-V_{CEO}$ max.	60	80	V
Collector current (d.c.)	$-I_C$ max.	1		A
Total power dissipation up to $T_{amb} = 25\text{ }^\circ\text{C}$	$P_{tot}$ max.	0,8		W
Junction temperature	$T_j$ max.	200		$^\circ\text{C}$
D.C. current gain		2N4030 2N4031	2N4032 2N4033	
$-I_C = 500\text{ mA}; -V_{CE} = 5\text{ V}$	$h_{FE} >$	25	70	
Transition frequency at $f = 100\text{ MHz}$	$f_T >$	100	150	MHz

### MECHANICAL DATA

Dimensions in mm

Fig. 1 TO-39.

Collector connected to case

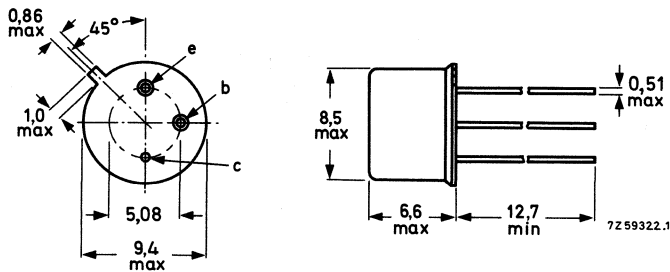

Maximum lead diameter is guaranteed only for 12,7 mm.

Accessories: 56245 (distance disc).

**RATINGS**

Limiting values in accordance with the Absolute Maximum System (IEC 134)

			2N4030 2N4032	2N4031 2N4033
Collector-base voltage (open emitter)	$-V_{CBO}$	max.	60	80 V
Collector-emitter voltage (open base)	$-V_{CEO}$	max.	60	80 V
Emitter-base voltage (open collector)	$-V_{EBO}$	max.	5	5 V
Collector current (d.c.)	$-I_C$	max.	1	A
Total power dissipation up to $T_{amb} = 25\text{ }^{\circ}\text{C}$	$P_{tot}$	max.	0,8	W
up to $T_{case} = 25\text{ }^{\circ}\text{C}$	$P_{tot}$	max.	4,0	W
Storage temperature	$T_{stg}$		-65 to +200	$^{\circ}\text{C}$
Junction temperature	$T_j$	max.	200	$^{\circ}\text{C}$

**THERMAL RESISTANCE**

From junction to ambient in free air	$R_{th\ j-a}$	=	218	K/W
From junction to case	$R_{th\ j-c}$	=	44	K/W

**CHARACTERISTICS** $T_{amb} = 25\text{ }^{\circ}\text{C}$  unless otherwise specified

			2N4030 2N4032	2N4031 2N4033
Collector cut-off current				
$I_E = 0; -V_{CB} = 50\text{ V}$	$-I_{CBO}$	<	50	- nA
$I_E = 0; -V_{CB} = 60\text{ V}$	$-I_{CBO}$	<	-	50 nA
$I_E = 0; -V_{CB} = 50\text{ V}; T_{amb} = 150\text{ }^{\circ}\text{C}$	$-I_{CBO}$	<	50	- $\mu\text{A}$
$I_E = 0; -V_{CB} = 60\text{ V}; T_{amb} = 150\text{ }^{\circ}\text{C}$	$-I_{CBO}$	<	-	50 $\mu\text{A}$
Emitter cut-off current				
$I_C = 0; -V_{EB} = 5\text{ V}$	$-I_{EBO}$	<	10	10 $\mu\text{A}$
Breakdown voltages				
$I_E = 0; -I_C = 10\text{ }\mu\text{A}$	$-V_{(BR)CBO}$	>	60	80 V
$I_B = 0; -I_C = 10\text{ mA}$	$-V_{(BR)CEO}$	>	60	80 V *
$I_C = 0; -I_E = 10\text{ }\mu\text{A}$	$-V_{(BR)EBO}$	>	5	5 V

\* Measured under pulse conditions:  $t_p = 300\text{ }\mu\text{s}; \delta \leq 0,01$ .

		2N4030 2N4032	2N4031 2N4033
<b>Base-emitter voltage</b>			
$-I_C = 500 \text{ mA}; -V_{CE} = 0,5 \text{ V}$	$-V_{BE}$	< 1,1	1,1 V *
$-I_C = 1000 \text{ mA}; -V_{CE} = 1,0 \text{ V}$	$-V_{BE}$	< 1,2	- V *
<b>Saturation voltages</b>			
$-I_C = 150 \text{ mA}; -I_B = 15 \text{ mA}$	$-V_{CEsat}$	< 0,15	0,15 V
	$-V_{BEsat}$	< 0,90	0,90 V *
$-I_C = 500 \text{ mA}; -I_B = 50 \text{ mA}$	$-V_{CEsat}$	< 0,50	0,50 V
$-I_C = 1000 \text{ mA}; -I_B = 100 \text{ mA}$	$-V_{CEsat}$	< 1,00	- V
<b>D.C. current gain *</b>			
$-I_C = 100 \mu\text{A}; -V_{CE} = 5 \text{ V}$	$h_{FE}$	> 30	75
$-I_C = 100 \text{ mA}; -V_{CE} = 5 \text{ V}$	$h_{FE}$	> 40	100
		< 120	300
$-I_C = 100 \text{ mA}; -V_{CE} = 5 \text{ V}; T_{amb} = -55 \text{ }^\circ\text{C}$	$h_{FE}$	> 15	40
$-I_C = 5000 \text{ mA}; -V_{CE} = 5 \text{ V}$	$h_{FE}$	> 25	70
$-I_C = 1000 \text{ mA}; -V_{CE} = 5 \text{ V}$	<b>2N4030</b>	> 15	
	<b>2N4031</b>	> 10	
	<b>2N4032</b>	> 40	
	<b>2N4033</b>	> 25	
<b>Collector capacitance at <math>f = 1 \text{ MHz}</math></b>			
$I_E = I_e = 0; -V_{CB} = 10 \text{ V}$	$C_c$	< 20	pF
<b>Emitter capacitance at <math>f = 1 \text{ MHz}</math></b>			
$I_C = I_c = 0; -V_{EB} = 0,5 \text{ V}$	$C_e$	< 110	pF
<b>Transition frequency at <math>f = 100 \text{ MHz}</math></b>			
$-I_C = 50 \text{ mA}; -V_{CE} = 10 \text{ V}$	$f_T$	> 100	150 MHz
		< 400	500 MHz

\* Measured under pulse conditions:  $t_p = 300 \mu\text{s}; \delta \leq 0,01$ .

Switching times

$-I_{Con} = 500 \text{ mA}; -I_{Bon} = 50 \text{ mA}$

Turn-on time

$t_{on} < 100 \text{ ns}$

$-I_{Con} = 500 \text{ mA}; -I_{Bon} = +I_{Boff} = 50 \text{ mA}$

Storage time

$t_s < 350 \text{ ns}$

Fall time

$t_f < 50 \text{ ns}$

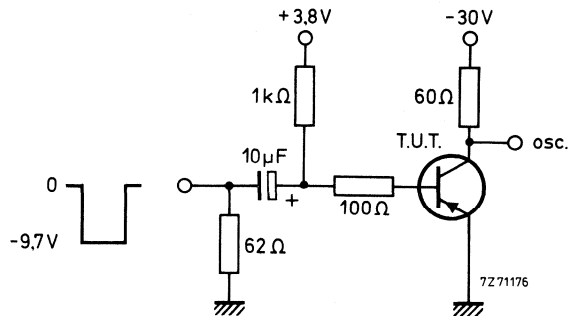

Fig. 2 Switching circuit.

Pulse generator:

Rise time  $t_r < 20 \text{ ns}$   
 Fall time  $t_f < 20 \text{ ns}$   
 Pulse duration  $t_p = 10 \mu\text{s}$   
 Duty factor  $\delta < 0,02$   
 Source impedance  $Z_S = 50 \Omega$

Oscilloscope:

Rise time  $t_r = 10 \text{ ns}$   
 Input impedance  $Z_I > 100 \text{ k}\Omega$

## PNP POWER TRANSISTOR

PNP power transistor, housed in a TO-39 metal envelope. It is intended for use in amplifier and switching applications.

### QUICK REFERENCE DATA

Collector-base voltage (open emitter)	$-V_{CB0}$	max.	90 V
Collector-emitter voltage (open base)	$-V_{CEO}$	max.	65 V
Collector current (DC)	$-I_C$	max.	1.0 A
Total power dissipation up to $T_{amb} = 25\text{ }^{\circ}\text{C}$	$P_{tot}$	max.	7.0 W
DC current gain $-I_C = 150\text{ mA}; -V_{CE} = 2\text{ V}$	$h_{FE}$		20 to 200

### MECHANICAL DATA

Dimensions in mm

Fig. 1 TO-39.

#### Pinning:

- 1 = emitter
- 2 = base
- 3 = collector

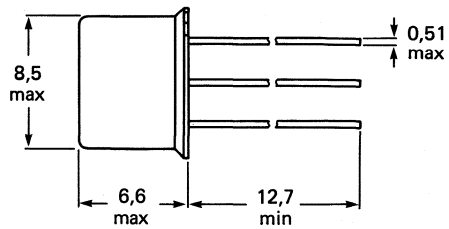
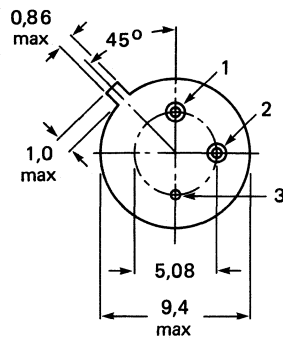
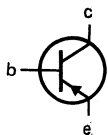

7Z59322.2

**RATINGS**

Limiting values in accordance with the Absolute Maximum System (IEC 134)

Collector-base voltage (open emitter)	$-V_{CB0}$	max.	90 V
Collector-emitter voltage (open base)	$-V_{CE0}$	max.	65 V
Emitter-base voltage (open collector)	$-V_{EBO}$	max.	7.0 V
Collector current (DC)	$-I_C$	max.	1.0 A
Base current	$-I_B$	max.	0.5 A
Total power dissipation up to $T_{amb} = 25\text{ }^\circ\text{C}$	$P_{tot}$	max.	7.0 W
Storage temperature range	$T_{stg}$		$-55$ to $+200\text{ }^\circ\text{C}$
Junction temperature	$T_j$	max.	$200\text{ }^\circ\text{C}$

**THERMAL RESISTANCE**

From junction to case	$R_{th\ j-c}$	25 K/W
-----------------------	---------------	--------

**CHARACTERISTICS** $T_{amb} = 25\text{ }^\circ\text{C}$  unless stated otherwise

Collector-emitter sustaining voltage $-I_C = 100\text{ mA}; I_B = 0$	$-V_{CE0sus}$	>	65 V
Collector cut-off current $-V_{CE} = 85\text{ V}; -V_{EB} = 1.5\text{ V}$ $-V_{CE} = 30\text{ V}; -V_{EB} = 1.5\text{ V}; T_c = 150\text{ }^\circ\text{C}$	$-I_{CEX}$	<	100 mA
	$-I_{CEX}$	<	0.1 mA
Collector cut-off current $-V_{CB} = 90\text{ V}; I_E = 0$	$-I_{CEO}$	<	100 $\mu\text{A}$
Emitter cut-off current $-V_{EB} = 7\text{ V}; I_C = 0$	$-I_{EBO}$	<	10 $\mu\text{A}$
DC current gain $-I_C = 150\text{ mA}; -V_{CE} = 2\text{ V}$ $-I_C = 0.1\text{ mA}; -V_{CE} = 10\text{ V}$ $-I_C = 150\text{ mA}; -V_{CE} = 10\text{ V}$ $-I_C = 150\text{ mA}; -V_{CE} = 10\text{ V}$	$h_{FE}$		20 to 200
	$h_{FE}$	>	20
	$h_{FE}$		40 to 140
	$h_{FE}$	>	20
Saturation voltages $-I_C = 150\text{ mA}; -I_B = 15\text{ mA}$	$-V_{CEsat}$	<	0.65 V
	$-V_{BEsat}$	<	1.4 V
Base-emitter on-state voltage $-I_C = 150\text{ mA}; -V_{CE} = 10\text{ V}$	$-V_{BE\ on}$	<	1.5 V
Collector-base capacitance $-V_{CB} = 10\text{ V}; f = 1\text{ MHz}$	$C_{cb}$	<	30 pF
High-frequency current gain $-I_C = 50\text{ mA}; -V_{CE} = 10\text{ V}; f = 20\text{ MHz}$	$h_{FE}$	>	3.0
Switching characteristics rise time; $I_{B1} = 15\text{ mA}$	$t_r$	<	70 ns
storage time; $I_{B2} = 15\text{ mA}$	$t_s$	<	600 ns
fall time; $I_{B2} = 15\text{ mA}$	$t_f$	<	100 ns
turn-on time; $I_{B1} = I_{B2}$	$t_{on}$	<	110 ns
turn-off time; $I_{B1} = I_{B2}$	$t_{off}$	<	700 ns





## SILICON PLANAR EPITAXIAL TRANSISTORS

N-P-N transistors in plastic TO-92 envelopes, primarily intended for low-power, small-signal audio-frequency applications for consumer service.

P-N-P complements are 2N4125 and 2N4126.

### QUICK REFERENCE DATA

		2N4123	2N4124
Collector-base voltage (open emitter)	$V_{CB0}$ max.	40	30 V
Collector-emitter voltage (open base)	$V_{CEO}$ max.	30	25 V
Collector current (d.c.)	$I_C$ max.	200	200 mA
Total power dissipation up to $T_{amb} = 25^\circ\text{C}$	$P_{tot}$ max.	350	350 mW
Junction temperature	$T_j$ max.	150	150 $^\circ\text{C}$
Small-signal current gain $I_C = 2\text{ mA}; V_{CE} = 10\text{ V}; f = 1\text{ kHz}$	$h_{fe} >$	50	120
	$h_{fe} <$	200	480
Transition frequency at $f = 100\text{ MHz}$ $I_C = 10\text{ mA}; V_{CE} = 20\text{ V}$	$f_T >$	250	300 MHz
Noise figure at $R_S = 1\text{ k}\Omega$ $I_C = 100\text{ }\mu\text{A}; V_{CE} = 5\text{ V}$ $f = 10\text{ Hz to }15,7\text{ kHz}$	$F <$	6	5 dB

### MECHANICAL DATA

Dimensions in mm

Fig. 1 TO-92.

#### Pinning

- 1 = collector
- 2 = base
- 3 = emitter

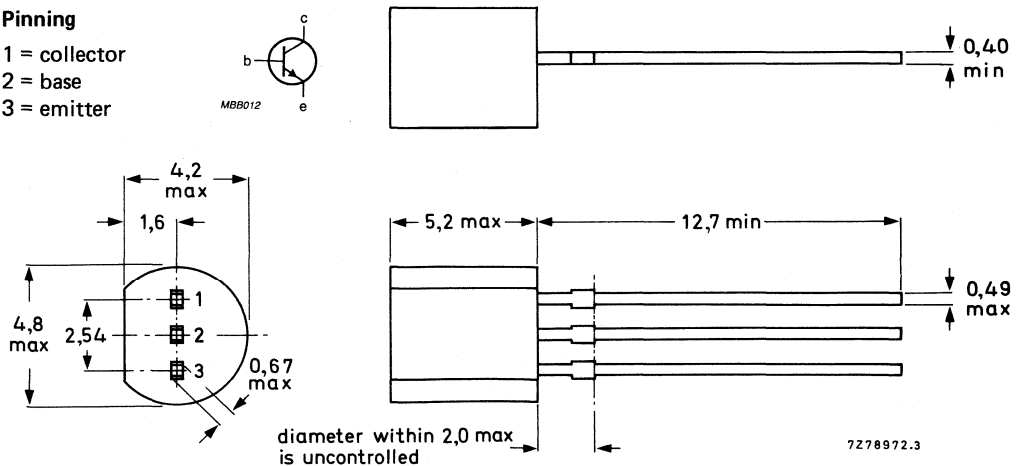
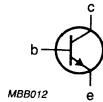

**RATINGS**

Limiting values in accordance with the Absolute Maximum System (IEC 134)

		2N4123	2N4124	
Collector-base voltage (open emitter)	$V_{CBO}$ max.	40	30	V
Collector-emitter voltage (open base)	$V_{CEO}$ max.	30	25	V
Emitter-base voltage (open collector)	$V_{EBO}$ max.	5		V
Collector current (d.c.)	$I_C$ max.	200		mA
Total power dissipation up to $T_{amb} = 25\text{ }^\circ\text{C}$	$P_{tot}$ max.	350		mW
Total power dissipation up to $T_{case} = 25\text{ }^\circ\text{C}$	$P_{tot}$ max.	1000		mW
Storage temperature range	$T_{stg}$	-65 to +150		$^\circ\text{C}$
Junction temperature	$T_j$ max.	150		$^\circ\text{C}$

**THERMAL RESISTANCE**

From junction to ambient in free air	$R_{th\ j-a}$ =	357	K/W
From junction to case	$R_{th\ j-c}$ =	125	K/W

**CHARACTERISTICS**

$T_{amb} = 25\text{ }^\circ\text{C}$

Collector cut-off current $I_E = 0; V_{CB} = 20\text{ V}$	$I_{CBO} <$	50	nA
Emitter cut-off current $I_C = 0; V_{EB} = 3\text{ V}$	$I_{EBO} <$	50	nA
Saturation voltages * $I_C = 50\text{ mA}; I_B = 5\text{ mA}$	$V_{CEsat} <$ $V_{BEsat} <$	300 950	mV mV

		2N4123	2N4124	
D.C. current gain * $I_C = 2\text{ mA}; V_{CE} = 1\text{ V}$	$h_{FE} >$	50	120	
	$h_{FE} <$	150	360	
$I_C = 50\text{ mA}; V_{CE} = 1\text{ V}$	$h_{FE} >$	25	60	
	$h_{FE} <$			
Collector capacitance at $f = 100\text{ kHz}$ $I_E = I_e = 0; V_{CB} = 5\text{ V}$	$C_c <$	4	4	pF
Emitter capacitance at $f = 100\text{ kHz}$ $I_C = I_c = 0; V_{EB} = 0,5\text{ V}$	$C_e <$	8	8	pF
Transition frequency at $f = 100\text{ MHz}$ $I_C = 10\text{ mA}; V_{CE} = 20\text{ V}$	$f_T >$	250	300	MHz
Noise figure at $R_S = 1\text{ k}\Omega$ $I_C = 100\text{ }\mu\text{A}; V_{CE} = 5\text{ V}$ $f = 10\text{ Hz to }15,7\text{ kHz}$	$F <$	6	5	dB
Small-signal current gain $I_C = 2\text{ mA}; V_{CE} = 10\text{ V}; f = 1\text{ kHz}$	$h_{fe} >$	50	120	
	$h_{fe} <$	200	480	

\* Measured under pulse conditions:  $t_p = 300\text{ }\mu\text{s}; \delta = 0,02$ .



## SILICON PLANAR EPITAXIAL TRANSISTORS

P-N-P transistors in plastic TO-92 envelopes, primarily intended for low-power, small-signal audio-frequency applications for consumer service.

N-P-N complements are 2N4123 and 2N4124.

### QUICK REFERENCE DATA

		2N4125	2N4126
Collector-base voltage (open emitter)	$-V_{CBO}$ max.	30	25 V
Collector-emitter voltage (open base)	$-V_{CEO}$ max.	30	25 V
Collector current (d.c.)	$-I_C$ max.	200	200 mA
Total power dissipation up to $T_{amb} = 25^\circ\text{C}$	$P_{tot}$ max.	350	350 mW
Junction temperature	$T_j$ max.	150	150 $^\circ\text{C}$
Small-signal current gain $-I_C = 2\text{ mA}; -V_{CE} = 10\text{ V}; f = 1\text{ kHz}$	$h_{fe} >$	50	120
	$h_{fe} <$	200	480
Transition frequency at $f = 100\text{ MHz}$ $-I_C = 10\text{ mA}; -V_{CE} = 20\text{ V}$	$f_T >$	200	250 MHz
Noise figure at $R_S = 1\text{ k}\Omega$ $-I_C = 100\text{ }\mu\text{A}; -V_{CE} = 5\text{ V}$ $f = 10\text{ Hz to }15,7\text{ kHz}$	$F <$	5	4 dB

### MECHANICAL DATA

Dimensions in mm

Fig. 1 TO-92.

#### Pinning

- 1 = collector
- 2 = base
- 3 = emitter

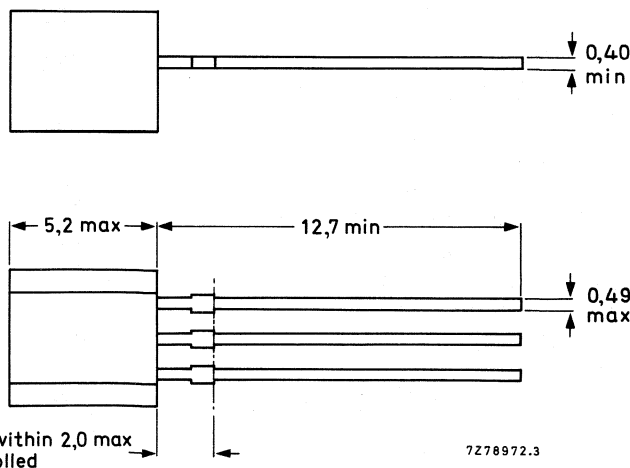
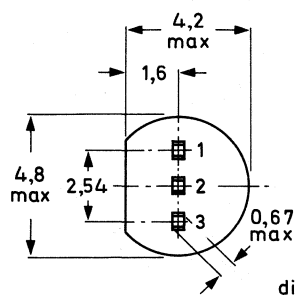
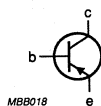

diameter within 2,0 max is uncontrolled

7278972.3

**RATINGS**

Limiting values in accordance with the Absolute Maximum System (IEC 134)

		2N4125	2N4126	
Collector-base voltage (open emitter)	$-V_{CBO}$ max.	30	25	V
Collector-emitter voltage (open base)	$-V_{CEO}$ max.	30	25	V
Emitter-base voltage (open collector)	$-V_{EBO}$ max.	4		V
Collector current (d.c.)	$-I_C$ max.	200		mA
Total power dissipation up to $T_{amb} = 25\text{ }^\circ\text{C}$	$P_{tot}$ max.	350		mW
Total power dissipation up to $T_{case} = 25\text{ }^\circ\text{C}$	$P_{tot}$ max.	1000		mW
Storage temperature range	$T_{stg}$	-65 to +150		$^\circ\text{C}$
Junction temperature	$T_j$ max.	150		$^\circ\text{C}$

**THERMAL RESISTANCE**

From junction to ambient in free air	$R_{th\ j-a}$ =	357	K/W
From junction to case	$R_{th\ j-c}$ =	125	K/W

**CHARACTERISTICS**

$T_{amb} = 25\text{ }^\circ\text{C}$

Collector cut-off current $I_E = 0; -V_{CB} = 20\text{ V}$	$-I_{CBO} <$	50	nA
Emitter cut-off current $I_C = 0; -V_{EB} = 3\text{ V}$	$-I_{EBO} <$	50	nA
Saturation voltages * $-I_C = 50\text{ mA}; -I_B = 5\text{ mA}$	$-V_{CEsat} <$	400	mV
	$-V_{BEsat} <$	950	mV

		2N4125	2N4126	
D.C. current gain * $-I_C = 2\text{ mA}; -V_{CE} = 1\text{ V}$	$h_{FE} >$	50	120	
	$h_{FE} <$	150	360	
$-I_C = 50\text{ mA}; -V_{CE} = 1\text{ V}$	$h_{FE} >$	25	60	
Collector capacitance at $f = 100\text{ kHz}$ $I_E = I_e = 0; -V_{CB} = 5\text{ V}$	$C_c <$	4,5	4,5	pF
Emitter capacitance at $f = 100\text{ kHz}$ $I_C = I_c = 0; -V_{EB} = 0,5\text{ V}$	$C_e <$	10	10	pF
Transition frequency at $f = 100\text{ MHz}$ $-I_C = 10\text{ mA}; -V_{CE} = 20\text{ V}$	$f_T >$	200	250	MHz
Noise figure at $R_S = 1\text{ k}\Omega$ $-I_C = 100\text{ }\mu\text{A}; -V_{CE} = 5\text{ V}$ $f = 10\text{ Hz to }15,7\text{ kHz}$	F <	5	4	dB
Small-signal current gain $-I_C = 2\text{ mA}; -V_{CE} = 10\text{ V}; f = 1\text{ kHz}$	$h_{fe} >$	50	120	
	$h_{fe} <$	200	480	

\* Measured under pulse conditions:  $t_p = 300\text{ }\mu\text{s}; \delta = 0,02$ .



## SILICON PLANAR EPITAXIAL TRANSISTORS

N-P-N silicon planar epitaxial transistors in plastic TO-92 envelope for use in general purpose applications.

### QUICK REFERENCE DATA

			2N4400	2N4401
Collector-emitter voltage (open base)	$V_{CEO}$	max.	40	V
Collector-base voltage (open emitter)	$V_{CBO}$	max.	60	V
Collector current (d.c.)	$I_C$	max.	600	mA
Total device dissipation at $T_{amb} = 25^\circ C$	$P_{tot}$	max.	625	mW
Collector-emitter saturation voltage $I_C = 500\text{ mA}; I_B = 50\text{ mA}$	$V_{CEsat}$	max.	0,75	V
D.C. current gain $I_C = 100\text{ mA}; V_{CE} = 2\text{ V}$	$h_{FE}$	min. max.	50 100	150 300

### MECHANICAL DATA

Dimensions in mm

Fig. 1 TO-92.

#### Pinning

- 1 = collector
- 2 = base
- 3 = emitter

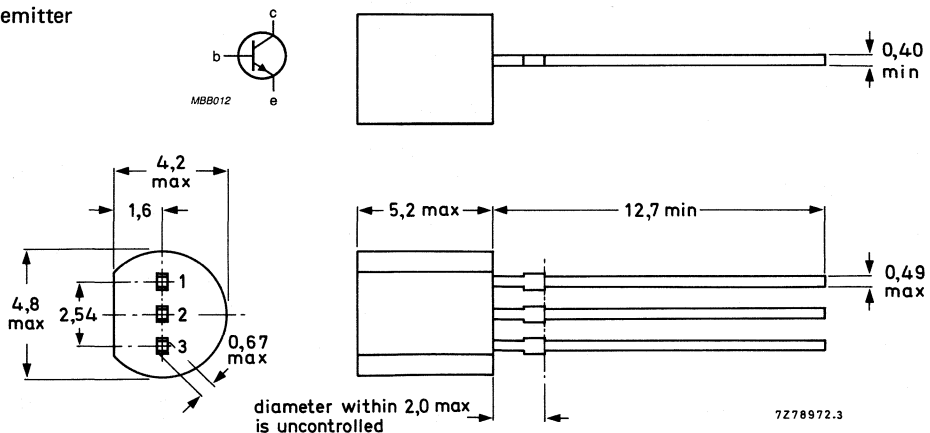

# 2N4400 2N4401

## RATINGS

Limiting values in accordance with the Absolute Maximum System (IEC 134)

			2N4400	2N4401
Collector-emitter voltage (open base)	$V_{CEO}$	max.	40	V
Collector-base voltage (open emitter)	$V_{CBO}$	max.	60	V
Emitter-base voltage (open collector)	$V_{EBO}$	max.	6	V
Collector current (d.c.)	$I_C$	max.	600	mA
Total power dissipation up to $T_{amb} = 25\text{ }^\circ\text{C}$	$P_{tot}$	max.	625	mW
Storage temperature range	$T_{stg}$		-65 to +150	$^\circ\text{C}$
Junction temperature	$T_j$	max.	150	$^\circ\text{C}$

## THERMAL RESISTANCE

From junction to ambient	$R_{th\ j-a}$	=	200	K/W
--------------------------	---------------	---	-----	-----

## CHARACTERISTICS

$T_j = 25\text{ }^\circ\text{C}$  unless otherwise specified

Collector-emitter breakdown voltage $I_B = 0$ ; $I_C = 1\text{ mA}$	$V_{(BR)CEO}$	min.	40	V
Collector-base breakdown voltage $I_E = 0$ ; $I_C = 0,1\text{ mA}$	$V_{(BR)CBO}$	min.	60	V
Emitter-base breakdown voltage $I_E = 0,1\text{ mA}$ ; $I_C = 0$	$V_{(BR)EBO}$	min.	6	V
Base cut-off current $V_{CE} = 35\text{ V}$ ; $-V_{BE} = 0,4\text{ V}$	$I_{BEX}$	max.	0,1	$\mu\text{A}$
Collector cut-off current $V_{CE} = 35\text{ V}$ ; $-V_{BE} = 0,4\text{ V}$	$I_{CEX}$	max.	0,1	$\mu\text{A}$
D.C. current gain $I_C = 0,1\text{ mA}$ ; $V_{CE} = 1\text{ V}$	$h_{FE}$	min.	20	40
$I_C = 1\text{ mA}$ ; $V_{CE} = 1\text{ V}$	$h_{FE}$	min.	40	80
$I_C = 10\text{ mA}$ ; $V_{CE} = 1\text{ V}$	$h_{FE}$	min.	50	100
$I_C = 150\text{ mA}$ ; $V_{CE} = 1\text{ V}$	$h_{FE}$	max.	150	300
$I_C = 500\text{ mA}$ ; $V_{CE} = 2\text{ V}$	$h_{FE}$	min.	20	40
Saturation voltages $I_C = 150\text{ mA}$ ; $I_B = 15\text{ mA}$	$V_{CEsat}$	max.	0,4	V
	$V_{BEsat}$	min.	0,75	V
	$V_{BEsat}$	max.	0,95	V
$I_C = 500\text{ mA}$ ; $I_B = 50\text{ mA}$	$V_{CEsat}$	max.	0,75	V
	$V_{BEsat}$	max.	1,2	V

		2N4400	2N4401
Transition frequency at $f = 100$ MHz $I_C = 20$ mA; $V_{CE} = 10$ V		$f_T$ min. 200	250 MHz
Collector-base capacitance $I_E = 0$ ; $V_{CB} = 5$ V; $f = 100$ kHz		$C_C$ max. 6,5	pF
Emitter-base capacitance $I_C = 0$ ; $V_{BE} = 0,5$ V; $f = 100$ kHz		$C_e$ max. 30	pF
Input impedance at $f = 1$ kHz $I_C = 1$ mA; $V_{CE} = 10$ V		$h_{ie}$ min. 0,5 max. 7,5	1,0 k $\Omega$ 15 k $\Omega$
Voltage feedback ratio at $f = 1$ kHz $I_C = 1$ mA; $V_{CE} = 10$ V		$h_{re}$ min. 0,1 max. 8,0	$\times 10^{-4}$ $\times 10^{-4}$
Small-signal current gain $I_C = 1$ mA; $V_{CE} = 10$ V; $f = 1$ kHz		$h_{fe}$ min. 20 max. 250	40 500
Output admittance at $f = 1$ kHz $I_C = 1$ mA; $V_{CE} = 10$ V		$h_{oe}$ min. 1,0 max. 30	$\mu S$ $\mu S$
<b>Switching times (resistive load)</b>			
Turn-on time			
$I_C = 150$ mA; $I_{B1} = 15$ mA; $V_{CC} = 30$ V; $V_{EB} = 2$ V			
delay time	$t_d$	max. 15	ns
rise time	$t_r$	max. 20	ns
Turn-off time			
$I_C = 150$ mA; $I_{B1} = I_{B2} = 15$ mA; $V_{CC} = 30$ V			
storage time	$t_s$	max. 225	ns
fall time	$t_f$	max. 30	ns







## SILICON PLANAR EPITAXIAL TRANSISTORS

P-N-P silicon planar epitaxial transistors in plastic TO-92 envelope for use in general purpose applications.

### QUICK REFERENCE DATA

			2N4402	2N4403
Collector-emitter voltage (open base)	$-V_{CEO}$	max.	40	V
Collector-base voltage (open emitter)	$-V_{CBO}$	max.	40	V
Collector current (d.c.)	$-I_C$	max.	600	mA
Total device dissipation at $T_{amb} = 25\text{ }^\circ\text{C}$	$P_{tot}$	max.	625	mW
Collector-emitter saturation voltage $-I_C = 500\text{ mA}; -I_B = 50\text{ mA}$	$-V_{CEsat}$	max.	0,75	V
D.C. current gain $-I_C = 150\text{ mA}; -V_{CE} = 2\text{ V}$	$h_{FE}$	min. max.	50 150	100 300

### MECHANICAL DATA

Dimensions in mm

Fig. 1 TO-92.

#### Pinning

- 1 = collector
- 2 = base
- 3 = emitter

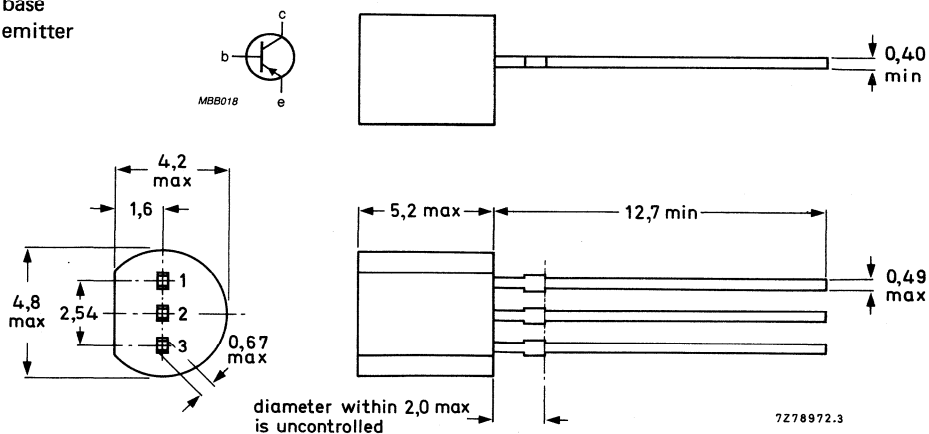

### RATINGS

Limiting values in accordance with the Absolute Maximum System (IEC 134)

			2N4402	2N4403
Collector-emitter voltage (open base)	$-V_{CEO}$	max.	40	V
Collector-base voltage (open emitter)	$-V_{CBO}$	max.	40	V
Emitter-base voltage (open collector)	$-V_{EBO}$	max.	5	V
Collector current (d.c.)	$-I_C$	max.	600	mA
Total power dissipation at $T_{amb} = 25\text{ }^{\circ}\text{C}$	$P_{tot}$	max.	625	mW
Storage temperature range	$T_{stg}$		-65 to +150	$^{\circ}\text{C}$
Junction temperature	$T_j$	max.	150	$^{\circ}\text{C}$

### THERMAL RESISTANCE

From junction to ambient	$R_{th\ j-a}$	=	200	K/W
--------------------------	---------------	---	-----	-----

### CHARACTERISTICS

$T_j = 25\text{ }^{\circ}\text{C}$  unless otherwise specified

Collector-emitter breakdown voltage $I_B = 0; -I_C = 1\text{ mA}$	$-V_{(BR)CEO}$	min.	40	V
Collector-base breakdown voltage $I_E = 0; -I_C = 0,1\text{ mA}$	$-V_{(BR)CBO}$	min.	40	V
Emitter-base breakdown voltage $-I_E = 0,1\text{ mA}; I_C = 0$	$-V_{(BR)EBO}$	min.	5	V
Base cut-off current $-V_{CE} = 35\text{ V}; V_{BE} = 0,4\text{ V}$	$-I_{BEX}$	max.	0,1	$\mu\text{A}$
Collector cut-off current $-V_{CE} = 35\text{ V}; V_{BE} = 0,4\text{ V}$	$-I_{CEX}$	max.	0,1	$\mu\text{A}$
D.C. current gain $-I_C = 0,1\text{ mA}; -V_{CE} = 1\text{ V}$	$h_{FE}$	min.		30
$-I_C = 1\text{ mA}; -V_{CE} = 1\text{ V}$	$h_{FE}$	min.	30	60
$-I_C = 10\text{ mA}; -V_{CE} = 1\text{ V}$	$h_{FE}$	min.	50	100
$-I_C = 150\text{ mA}; -V_{CE} = 2\text{ V}$	$h_{FE}$	min. max.	50 150	100 300
$-I_C = 500\text{ mA}; -V_{CE} = 2\text{ V}$	$h_{FE}$	min.	20	
Saturation voltages $-I_C = 150\text{ mA}; -I_B = 15\text{ mA}$	$-V_{CEsat}$	max.	0,4	V
	$-V_{BEsat}$	min.	0,75	V
	$-V_{BEsat}$	max.	0,95	V
$-I_C = 500\text{ mA}; -I_B = 50\text{ mA}$	$-V_{CEsat}$	max.	0,75	V
	$-V_{BEsat}$	max.	1,3	V

			2N4402	2N4403	
Transition frequency at $f = 100$ MHz $-I_C = 20$ mA; $-V_{CE} = 10$ V			$f_T$	min. 150	200 MHz
Collector-base capacitance $I_E = 0$ ; $-V_{CB} = 10$ V; $f = 140$ kHz			$C_{cb}$	max. 8,5	pF
Emitter-base capacitance $I_C = 0$ ; $-V_{BE} = 0,5$ V; $f = 140$ kHz			$C_{eb}$	max. 30	pF
<b>Switching times (resistive load)</b>					
Turn-on time					
$-I_C = 150$ mA; $-I_{B1} = 15$ mA; $-V_{CC} = 30$ V; $-V_{EB} = 2$ V					
delay time	$t_d$	max.	15	ns	
rise time	$t_r$	max.	20	ns	
Turn-off time					
$-I_C = 150$ mA; $-I_{B1} = I_{B2} = 15$ mA; $-V_{CC} = 30$ V					
storage time	$t_s$	max.	225	ns	
fall time	$t_f$	max.	30	ns	





## SILICON PLANAR EPITAXIAL TRANSISTORS

P-N-P small-signal transistors in plastic TO-92 envelope intended for low-noise stages in audio equipment. Complementary types are 2N5088/2N5089.

### QUICK REFERENCE DATA

Collector-emitter voltage (open base)	$-V_{CEO}$	max.	50	V
Collector-base voltage (open emitter)	$-V_{CBO}$	max.	50	V
Collector current (d.c.)	$-I_C$	max.	50	mA
Total power dissipation up to $T_{amb} = 25^\circ\text{C}$	$P_{tot}$	max.	625	mW
Collector-emitter saturation voltage $-I_C = 10\text{ mA}; -I_B = 1\text{ mA}$	$-V_{CEsat}$	max.	0,3	V
			2N5086	2N5087
D.C. current gain $-I_C = 1\text{ mA}; -V_{CE} = 5\text{ V}$	$h_{FE}$	min.	150	250

### MECHANICAL DATA

Dimensions in mm

Fig. 1 TO-92.

#### Pinning

- 1 = collector
- 2 = base
- 3 = emitter

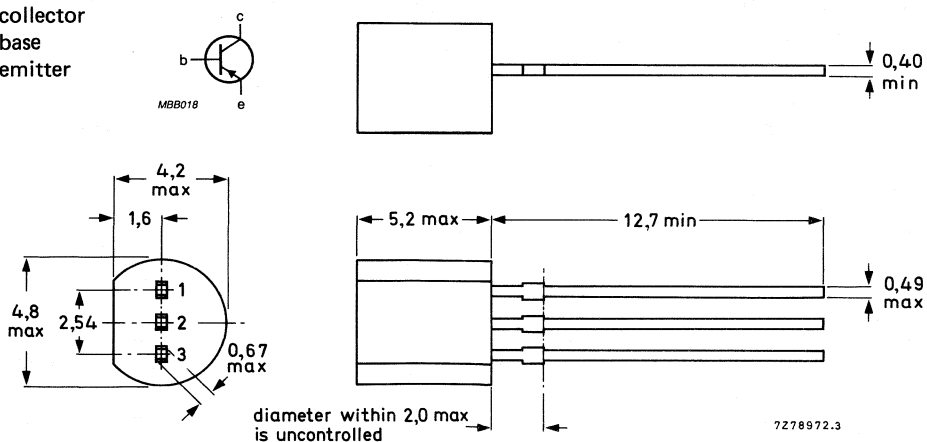

**RATINGS**

Limiting values in accordance with the Absolute Maximum System (IEC 134)

Collector-emitter voltage (open base)	$-V_{CEO}$	max.	50	V
Collector-base voltage (open emitter)	$-V_{CBO}$	max.	50	V
Emitter-base voltage (open collector)	$-V_{EBO}$	max.	3,0	V
Collector current (d.c.)	$-I_C$	max.	50	mA
Total power dissipation up to $T_{amb} = 25\text{ }^\circ\text{C}$	$P_{tot}$	max.	625	mW
Storage temperature range	$T_{stg}$		-65 to +150	$^\circ\text{C}$
Junction temperature	$T_j$	max.	150	$^\circ\text{C}$

**THERMAL RESISTANCE**

From junction to ambient in free air	$R_{th\ j-a}$	=	200	K/W
--------------------------------------	---------------	---	-----	-----

**CHARACTERISTICS**

$T_j = 25\text{ }^\circ\text{C}$  unless otherwise specified

Collector-emitter breakdown voltage $I_B = 0; -I_C = 1\text{ mA}$	$-V_{(BR)CEO}$	min.	50	V																									
Collector-base breakdown voltage $I_E = 0; -I_C = 100\text{ }\mu\text{A}$	$-V_{(BR)CBO}$	min.	50	V																									
Collector cut-off current $-V_{CB} = 10\text{ V}; I_E = 0$ $-V_{CB} = 35\text{ V}; I_E = 0$	$-I_{CBO}$	max. max.	10 50	nA nA																									
Emitter cut-off current $-V_{EB} = 3\text{ V}; I_C = 0$	$-I_{EBO}$	max.	50	nA																									
Collector-emitter saturation voltage $-I_C = 10\text{ mA}; -I_B = 1\text{ mA}$	$-V_{CEsat}$	max.	0,3	V																									
Base-emitter ON-voltage $-I_C = 1\text{ mA}; -V_{CE} = 5\text{ V}$	$-V_{BEon}$	max.	0,85	V																									
Transition frequency at $f = 20\text{ MHz}$ $-I_C = 500\text{ }\mu\text{A}; -V_{CE} = 5\text{ V}$	$f_T$	min.	40	MHz																									
Collector capacitance at $f = 100\text{ kHz}$ $-V_{CB} = 5\text{ V}; I_E = 0$	$C_c$	max.	4,0	pF																									
<table border="1" style="margin-left: auto; margin-right: auto;"> <thead> <tr> <th colspan="2"></th> <th style="border-right: 1px solid black;">2N5086</th> <th>2N5087</th> </tr> </thead> <tbody> <tr> <td rowspan="2">D.C. current gain <math>-I_C = 100\text{ }\mu\text{A}; -V_{CE} = 5\text{ V}</math></td> <td><math>h_{FE}</math></td> <td style="border-right: 1px solid black;">min. 150</td> <td>250</td> </tr> <tr> <td></td> <td style="border-right: 1px solid black;">max. 500</td> <td>800</td> </tr> <tr> <td rowspan="2"><math>-I_C = 1\text{ mA}; -V_{CE} = 5\text{ V}</math> <math>-I_C = 10\text{ mA}; -V_{CE} = 5\text{ V}</math></td> <td><math>h_{FE}</math></td> <td style="border-right: 1px solid black;">min. 150</td> <td>250</td> </tr> <tr> <td></td> <td style="border-right: 1px solid black;">min. 150</td> <td>250</td> </tr> <tr> <td rowspan="2">Small-signal current gain at <math>f = 1\text{ kHz}</math> <math>-I_C = 1\text{ mA}; -V_{CE} = 5\text{ V}</math></td> <td><math>h_{fe}</math></td> <td style="border-right: 1px solid black;">min. 150</td> <td>250</td> </tr> <tr> <td></td> <td style="border-right: 1px solid black;">max. 600</td> <td>900</td> </tr> </tbody> </table>							2N5086	2N5087	D.C. current gain $-I_C = 100\text{ }\mu\text{A}; -V_{CE} = 5\text{ V}$	$h_{FE}$	min. 150	250		max. 500	800	$-I_C = 1\text{ mA}; -V_{CE} = 5\text{ V}$ $-I_C = 10\text{ mA}; -V_{CE} = 5\text{ V}$	$h_{FE}$	min. 150	250		min. 150	250	Small-signal current gain at $f = 1\text{ kHz}$ $-I_C = 1\text{ mA}; -V_{CE} = 5\text{ V}$	$h_{fe}$	min. 150	250		max. 600	900
		2N5086	2N5087																										
D.C. current gain $-I_C = 100\text{ }\mu\text{A}; -V_{CE} = 5\text{ V}$	$h_{FE}$	min. 150	250																										
		max. 500	800																										
$-I_C = 1\text{ mA}; -V_{CE} = 5\text{ V}$ $-I_C = 10\text{ mA}; -V_{CE} = 5\text{ V}$	$h_{FE}$	min. 150	250																										
		min. 150	250																										
Small-signal current gain at $f = 1\text{ kHz}$ $-I_C = 1\text{ mA}; -V_{CE} = 5\text{ V}$	$h_{fe}$	min. 150	250																										
		max. 600	900																										

			2N5086	2N5087
Noise figure at $-V_{CE} = 5 \text{ V}$ ; $T_{\text{amb}} = 25 \text{ }^{\circ}\text{C}$				
$-I_C = 20 \text{ } \mu\text{A}$ ; $R_S = 10 \text{ k}\Omega$ ; $f = 10 \text{ Hz to } 15,7 \text{ kHz}$	F	max.	3,0	2,0 dB
$-I_C = 100 \text{ } \mu\text{A}$ ; $R_S = 3 \text{ k}\Omega$ ; $f = 1 \text{ kHz}$	F	max.	3,0	2,0 dB







## SILICON PLANAR EPITAXIAL TRANSISTOR

NPN small-signal transistor in plastic TO-92 envelope intended for low-noise stages in audio equipment. Complementary type is 2N5086.

### QUICK REFERENCE DATA

Collector-emitter voltage (open base)	$V_{CEO}$	max.	30 V
Collector-base voltage (open emitter)	$V_{CBO}$	max.	35 V
Collector current (DC)	$I_C$	max.	50 mA
Total power dissipation up to $T_{amb} = 25\text{ }^\circ\text{C}$	$P_{tot}$	max.	625 mW
Collector-emitter saturation voltage $I_C = 10\text{ mA}; I_B = 1\text{ mA}$	$V_{CEsat}$	max.	0.5 V
DC current gain $I_C = 1\text{ mA}; V_{CE} = 5\text{ V}$	$h_{FE}$	min.	350

### MECHANICAL DATA

Dimensions in mm

Fig.1 TO-92.

#### Pinning

- 1 = collector
- 2 = base
- 3 = emitter

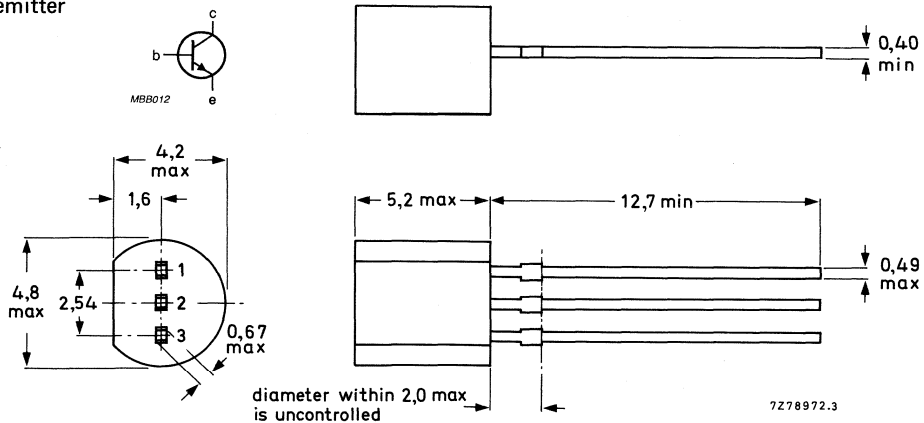

**RATINGS**

Limiting values in accordance with the Absolute Maximum System (IEC 134)

Collector-emitter voltage (open base)	$V_{CEO}$	max.	30 V
Collector-base voltage (open emitter)	$V_{CBO}$	max.	35 V
Emitter-base voltage (open collector)	$V_{EBO}$	max.	4.5 V
Collector current (DC)	$I_C$	max.	50 mA
Total power dissipation up to $T_{amb} = 25\text{ }^\circ\text{C}$	$P_{tot}$	max.	625 mW
Storage temperature range	$T_{stg}$		-65 to + 150 $^\circ\text{C}$
Junction temperature	$T_j$	max.	150 $^\circ\text{C}$

**THERMAL RESISTANCE**

From junction to ambient in free air	$R_{th\ j-a}$	=	200 K/W
--------------------------------------	---------------	---	---------

**CHARACTERISTICS** $T_j = 25\text{ }^\circ\text{C}$  unless otherwise specified

Collector-emitter breakdown voltage $I_B = 0$ ; $I_C = 1\text{ mA}$	$V_{(BR)CEO}$	min.	30 V
Collector-base breakdown voltage $I_E = 0$ ; $I_C = 100\text{ }\mu\text{A}$	$V_{(BR)CBO}$	min.	35 V
Collector cut-off current $V_{CB} = 20\text{ V}$ ; $I_E = 0$	$I_{CBO}$	max.	50 nA
Emitter cut-off current $V_{EBoff} = 3\text{ V}$ ; $I_C = 0$ $V_{EBoff} = 4.5\text{ V}$ ; $I_C = 0$	$I_{EBO}$	max.	50 nA 100 nA
Collector-emitter saturation voltage $I_C = 10\text{ mA}$ ; $I_B = 1\text{ mA}$	$V_{CEsat}$	max.	0.5 V
Base-emitter ON-voltage $I_C = 10\text{ mA}$ ; $V_{CE} = 5\text{ V}$	$V_{BEon}$	max.	0.8 V
Transition frequency at $f = 20\text{ MHz}$ $I_C = 500\text{ }\mu\text{A}$ ; $V_{CE} = 5\text{ V}$	$f_T$	min.	50 MHz
DC current gain $I_C = 100\text{ }\mu\text{A}$ ; $V_{CE} = 5\text{ V}$	$h_{FE}$	min.	300
$I_C = 1\text{ mA}$ ; $V_{CE} = 5\text{ V}$		max.	900
$I_C = 10\text{ mA}$ ; $V_{CE} = 5\text{ V}$	$h_{FE}$	min.	350
		min.	300
Small-signal current gain at $f = 1\text{ kHz}$ $I_C = 1\text{ mA}$ ; $V_{CE} = 5\text{ V}$	$h_{fe}$	min.	350
		max.	1400
Noise figure at $R_S = 10\text{ k}\Omega$ ; $T_{amb} = 25\text{ }^\circ\text{C}$ $I_C = 100\text{ }\mu\text{A}$ ; $V_{CE} = 5\text{ V}$ ; $f = 10\text{ Hz to } 15.7\text{ kHz}$	F	max.	3.0 dB
Collector capacitance at $f = 100\text{ kHz}$ $V_{CB} = 5\text{ V}$ ; $I_E = 0$	$C_C$	max.	4.0 pF
Emitter capacitance at $f = 100\text{ kHz}$ $V_{BE} = 0.5\text{ V}$ ; $I_C = 0$	$C_e$	max.	10 pF



## SILICON P-N-P HIGH-VOLTAGE TRANSISTORS

P-N-P high-voltage small-signal transistors for general purposes and especially in telephony applications and encapsulated in a TO-92 envelope.

N-P-N complements are 2N5550 and 2N5551.

### QUICK REFERENCE DATA

		2N5400	2N5401	
Collector-base voltage (open emitter)	$-V_{CBO}$ max.	130	160	V
Collector-emitter voltage (open base)	$-V_{CEO}$ max.	120	150	V
Collector current	$-I_C$ max.	600	600	mA
Total power dissipation up to $T_{amb} = 25\text{ }^\circ\text{C}$	$P_{tot}$ max.	500	500	mW
Junction temperature	$T_j$ max.	150	150	$^\circ\text{C}$
Collector-emitter saturation voltage $I_C = 50\text{ mA}; I_B = 5\text{ mA}$	$V_{CEsat}$ max.	0,5	0,5	V
D.C. current gain $I_C = 10\text{ mA}; V_{CE} = -5\text{ V}$	$h_{FE}$ min.	40	60	

### MECHANICAL DATA

Dimensions in mm

Fig. 1 TO-92.

#### Pinning

- 1 = collector
- 2 = base
- 3 = emitter

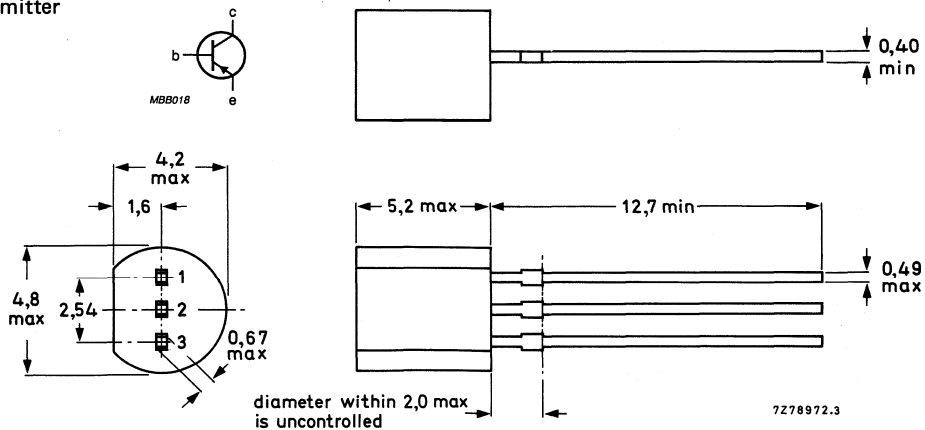

**RATINGS**

Limiting values in accordance with the Absolute Maximum System (IEC 134)

			2N5400	2N5401	
Collector-base voltage (open emitter)	$-V_{CB0}$	max.	130	160	V
Collector-emitter voltage (open base)	$-V_{CEO}$	max.	120	150	V
Emitter-base voltage (open collector)	$-V_{EBO}$	max.	5		V
Collector current	$-I_C$	max.	600		mA
Total power dissipation up to $T_{amb} = 25\text{ }^\circ\text{C}$	$P_{tot}$	max.	500		mW
Junction temperature	$T_j$	max.	150		$^\circ\text{C}$
Storage temperature range	$T_{stg}$		-65 to + 150		$^\circ\text{C}$

**THERMAL RESISTANCE**

From junction to ambient	$R_{th\ j-a}$	max.	250		K/W
--------------------------	---------------	------	-----	--	-----

**CHARACTERISTICS**

$T_{amb} = 25\text{ }^\circ\text{C}$  unless otherwise specified

			2N5400	2N5401	
Collector cut-off current					
$I_E = 0; -V_{CB} = 100\text{ V}$	$-I_{CBO}$	max.	100		nA
$I_E = 0; -V_{CB} = 120\text{ V}$	$-I_{CBO}$	max.		50	nA
$I_E = 0; -V_{CB} = 100\text{ V}; T_{amb} = 100\text{ }^\circ\text{C}$	$-I_{CBO}$	max.	100		$\mu\text{A}$
$I_E = 0; -V_{CB} = 120\text{ V}; T_{amb} = 100\text{ }^\circ\text{C}$	$-I_{CBO}$	max.		50	$\mu\text{A}$
Emitter cut-off current					
$I_C = 0; -V_{EB} = 4,0\text{ V}$	$-I_{EBO}$	max.	50	50	nA
Breakdown voltages					
$I_C = 1,0\text{ mA}; I_E = 0$	$-V_{(BR)CEO}$	min.	120	150	V
$I_C = 100\text{ }\mu\text{A}; I_E = 0$	$-V_{(BR)CBO}$	min.	130	160	V
$I_C = 0; I_E = 10\text{ }\mu\text{A}$	$-V_{(BR)EBO}$	min.	5,0	5,0	V
Saturation voltages					
$-I_C = 10\text{ mA}; -I_B = 1,0\text{ mA}$	$-V_{CEsat}$	max.	0,2	0,2	V
	$-V_{BEsat}$	max.	1,0	1,0	V
$-I_C = 50\text{ mA}; -I_B = 5,0\text{ mA}$	$-V_{CEsat}$	max.	0,5	0,5	V
	$-V_{BEsat}$	max.	1,0	1,0	V
D.C. current gain					
$I_C = 1,0\text{ mA}; -V_{CE} = 5\text{ V}$	$h_{FE}$	min.	30	50	
		min.	40	60	
$I_C = 10\text{ mA}; -V_{CE} = 5\text{ V}$	$h_{FE}$	max.	180	240	
$I_C = 50\text{ mA}; -V_{CE} = 5\text{ V}$	$h_{FE}$	min.	40	50	
Small-signal current gain					
$I_C = 1,0\text{ mA}; -V_{CE} = 10\text{ V}; f = 1\text{ kHz}$	$h_{fe}$	min.	30	40	
		max.	200	200	
Output capacitance at $f = 1\text{ MHz}$					
$I_E = 0; -V_{CB} = 10\text{ V}$	$C_o$	max.	6	6	pF

		2N5400	2N5401	
Transition frequency at $f = 100$ MHz $-I_C = 10$ mA; $-V_{CE} = 10$ V	$f_T$	min.	100	100 MHz
		max.	400	300 MHz
Noise figure at $R_S = 1$ k $\Omega$ $I_C = 250$ $\mu$ A; $-V_{CE} = 5$ V; $f = 10$ Hz to 15,7 kHz	F	max.	8	8 dB



## SILICON P-N-P HIGH-VOLTAGE TRANSISTORS

Transistors in TO-39 metal envelopes with the collector connected to the case. They are intended for high-speed switching and linear amplifier applications in military, industrial and commercial equipment.

### QUICK REFERENCE DATA

		2N5415	2N5416
Collector-base voltage (open emitter)	$-V_{CBO}$ max.	200	350 V
Collector-emitter voltage (open base)	$-V_{CEO}$ max.	200	300 V
Collector current (d.c.)	$-I_C$ max.	1	1 A
Total power dissipation up to $T_{amb} = 50^\circ\text{C}$	$P_{tot}$ max.	1	1 W
Junction temperature	$T_j$ max.	200	200 $^\circ\text{C}$
D.C. current gain	$h_{FE}$	> 30	30
$-I_C = 50\text{ mA}; -V_{CE} = 10\text{ V}$		< 150	120

### MECHANICAL DATA

Dimensions in mm

Fig. 1 TO-39.

Collector connected to case

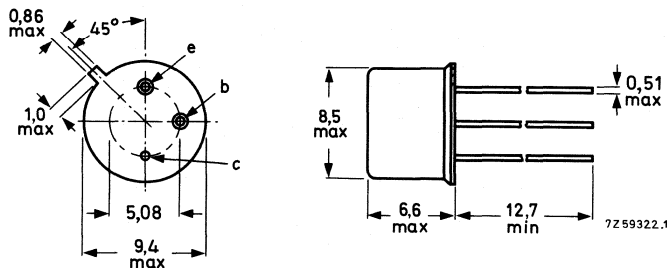

Maximum lead diameter is guaranteed only for 12,7 mm.

**RATINGS**

Limiting values in accordance with the Absolute Maximum System (IEC 134)

		2N5415	2N5416
Collector-base voltage (open emitter)	$-V_{CBO}$ max.	200	350 V
Collector-emitter voltage (open base)	$-V_{CEO}$ max.	200	300 V
Emitter-base voltage (open collector)	$-V_{EBO}$ max.	4	6 V
Collector current (d.c.)	$-I_C$ max.	1	A
Base current (d.c.)	$-I_B$ max.	0,5	A
Total power dissipation up to $T_{case} = 25\text{ }^\circ\text{C}$	$P_{tot}$ max.	10	W
Total power dissipation up to $T_{amb} = 50\text{ }^\circ\text{C}$	$P_{tot}$ max.	1	W

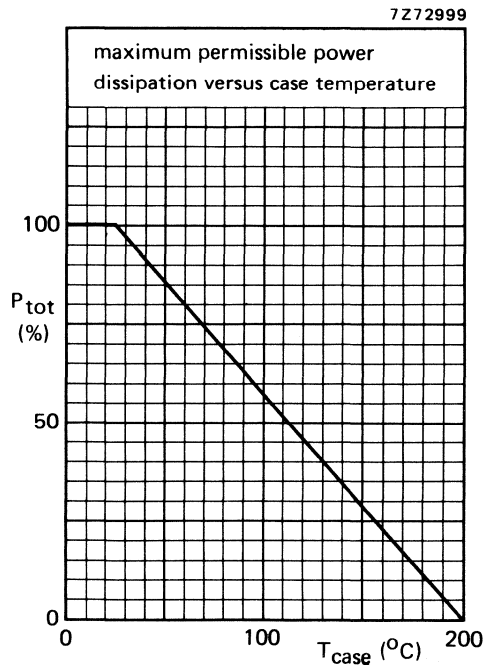

Fig. 2.

Storage temperature range	$T_{stg}$	-65 to +150	$^\circ\text{C}$
Junction temperature	$T_j$ max.	200	$^\circ\text{C}$

**THERMAL RESISTANCE**

From junction to case	$R_{th\ j-c}$	=	17,5	K/W
From junction to ambient in free air	$R_{th\ j-a}$	=	150	K/W



**CHARACTERISTICS**

$T_{case} = 25\text{ }^{\circ}\text{C}$  unless otherwise specified

Collector cut-off currents

$I_E = 0; -V_{CB} = 175\text{ V}$

$I_E = 0; -V_{CB} = 280\text{ V}$

$I_B = 0; -V_{CE} = 150\text{ V}$

$I_B = 0; -V_{CE} = 250\text{ V}$

Emitter cut-off current

$I_C = 0; -V_{EB} = 4\text{ V}$

$I_C = 0; -V_{EB} = 6\text{ V}$

Sustaining voltage

$I_B = 0; -I_C = 0\text{ to }50\text{ mA}$

		2N5415	2N5416
$-I_{CBO}$	<	50	— $\mu\text{A}$
$-I_{CBO}$	<	—	50 $\mu\text{A}$
$-I_{CEO}$	<	50	— $\mu\text{A}$
$-I_{CEO}$	<	—	50 $\mu\text{A}$
$-I_{EBO}$	<	20	— $\mu\text{A}$
$-I_{EBO}$	<	—	20 $\mu\text{A}$
$-V_{CEO_{sust}}$	>	200	300 V*

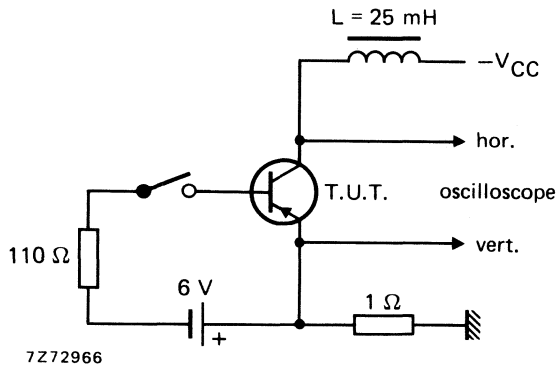

Fig. 3 Test circuit for  $V_{CEO_{sust}}$ .

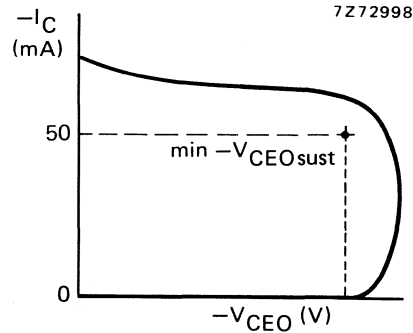

Fig. 4 Oscilloscope display for  $V_{CEO_{sust}}$ .

Saturation voltages

$-I_C = 50\text{ mA}; -I_B = 5\text{ mA}$

D.C. current gain

$-I_C = 50\text{ mA}; -V_{CE} = 10\text{ V}$

Collector capacitance at  $f = 1\text{ MHz}$

$I_E = I_e = 0; -V_{CB} = 10\text{ V}$

Emitter capacitance at  $f = 1\text{ MHz}$

$I_C = I_c = 0; -V_{EB} = -V_{EBO_{max}}$

$-V_{CE_{sat}}$	<	2,5	2,0 V
$-V_{BE_{sat}}$	<	1,5	1,5 V
$h_{FE}$	>	30	30
	<	150	120
$C_c$	<	15	pF
$C_e$	<	75	pF

\* Measured under pulse conditions to avoid excessive dissipation.

2N5415  
2N5416

Transition frequency at  $f = 5 \text{ MHz}$

$-I_C = 10 \text{ mA}; -V_{CE} = 10 \text{ V}$

$f_T > 15 \text{ MHz}$

**h-parameters (common emitter)**

$-I_C = 5 \text{ mA}; -V_{CE} = 10 \text{ V}$

real part of input impedance at  $f = 1 \text{ MHz}$

$R_e(h_{ie}) < 300 \ \Omega$

small-signal current gain at  $f = 1 \text{ kHz}$

$h_{fe} > 25$



## SILICON N-P-N HIGH-VOLTAGE TRANSISTORS

N-P-N high-voltage small-signal transistors for general purposes and especially telephony applications and encapsulated in a TO-92 envelope.

P-N-P complements are 2N5400 and 2N5401.

### QUICK REFERENCE DATA

			2N5550	2N5551	
Collector-base voltage (open emitter)	$V_{CBO}$	max.	160	180	V
Collector-emitter voltage (open base)	$V_{CEO}$	max.	140	160	V
Collector current	$I_C$	max.	600	600	mA
Total power dissipation up to $T_{amb} = 25\text{ }^\circ\text{C}$	$P_{tot}$	max.	500	500	mW
Junction temperature	$T_j$	max.	150	150	$^\circ\text{C}$
Collector-emitter saturation voltage $I_C = 50\text{ mA}; I_B = 5\text{ mA}$	$V_{CEsat}$	max.	0,25	0,20	V
D.C. current gain $I_C = 10\text{ mA}; V_{CE} = 5\text{ V}$	$h_{FE}$	min.	60	80	

### MECHANICAL DATA

Dimensions in mm

Fig. 1 TO-92.

#### Pinning

- 1 = collector .
- 2 = base
- 3 = emitter

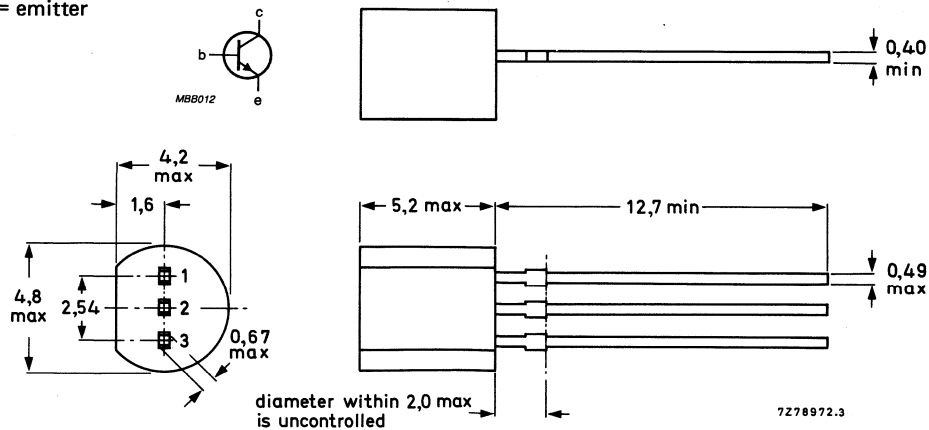

**RATINGS**

Limiting values in accordance with the Absolute Maximum System (IEC 134)

			2N5550	2N5551	
Collector-base voltage (open emitter)	$V_{CBO}$	max.	160	180	V
Collector-emitter voltage (open base)	$V_{CEO}$	max.	140	160	V
Emitter-base voltage (open collector)	$V_{EBO}$	max.	6		V
Collector current	$I_C$	max.	600		mA
Total power dissipation up to $T_{amb} = 25\text{ }^\circ\text{C}$	$P_{tot}$	max.	500		mW
Junction temperature	$T_j$	max.	150		$^\circ\text{C}$
Storage temperature range	$T_{stg}$		-65 to + 150		$^\circ\text{C}$

**THERMAL RESISTANCE**

From junction to ambient	$R_{th\ j-a}$	max.	250	K/W
--------------------------	---------------	------	-----	-----

**CHARACTERISTICS**

$T_{amb} = 25\text{ }^\circ\text{C}$  unless otherwise specified

			2N5550	2N5551	
Collector cut-off current					
$I_E = 0; V_{CB} = 100\text{ V}$	$I_{CBO}$	max.	100		nA
$I_E = 0; V_{CB} = 120\text{ V}$	$I_{CBO}$	max.		50	nA
$I_E = 0; V_{CB} = 100\text{ V}; T_{amb} = 100\text{ }^\circ\text{C}$	$I_{CBO}$	max.	100		$\mu\text{A}$
$I_E = 0; V_{CB} = 120\text{ V}; T_{amb} = 100\text{ }^\circ\text{C}$	$I_{CBO}$	max.		50	$\mu\text{A}$
Emitter cut-off current					
$I_C = 0; V_{EB} = 4,0\text{ V}$	$I_{EBO}$	max.	50	50	nA
Breakdown voltages					
$I_C = 1,0\text{ mA}; I_B = 0$	$V_{(BR)CEO}$	min.	140	160	V
$I_C = 100\text{ }\mu\text{A}; I_E = 0$	$V_{(BR)CBO}$	min.	160	180	V
$I_C = 0; I_E = 10\text{ }\mu\text{A}$	$V_{(BR)EBO}$	min.	6,0	6,0	V
Saturation voltages					
$I_C = 10\text{ mA}; I_B = 1,0\text{ mA}$	$V_{CEsat}$	max.	0,15	0,15	V
	$V_{BEsat}$	max.	1,0	1,0	V
$I_C = 50\text{ mA}; I_B = 5,0\text{ mA}$	$V_{CEsat}$	max.	0,25	0,20	V
	$V_{BEsat}$	max.	1,2	1,0	V
D.C. current gain					
$I_C = 1,0\text{ mA}; V_{CE} = 5\text{ V}$	$h_{FE}$	min.	60	80	
		min.	60	80	
$I_C = 10\text{ mA}; V_{CE} = 5\text{ V}$	$h_{FE}$	max.	250	250	
	$h_{FE}$	min.	20	30	
$I_C = 50\text{ mA}; V_{CE} = 5\text{ V}$	$h_{FE}$				
Small-signal current gain					
$I_C = 1,0\text{ mA}; V_{CE} = 10\text{ V}; f = 1\text{ kHz}$	$h_{fe}$	min.	50	50	
		max.	200	200	
Output capacitance at $f = 1\text{ MHz}$					
$I_E = 0; V_{CB} = 10\text{ V}$	$C_o$	max.	6	6	pF
Input capacitance at $f = 1\text{ MHz}$					
$I_C = 0; V_{EB} = 0,5\text{ V}$	$C_i$	max.	30	30	pF

		2N5550	2N5551	
Transition frequency at $f = 100$ MHz				
$I_C = 10$ mA; $V_{CE} = 10$ V	$f_T$	min. 100	100	MHz
		max. 300	300	MHz
Noise figure at $R_S = 1$ k $\Omega$				
$I_C = 250$ $\mu$ A; $V_{CE} = 5$ V; $f = 10$ Hz to 15,7 kHz	F	max. 10	8	dB



# Silicon planar epitaxial transistor

2N5680

## QUICK REFERENCE DATA

SYMBOL	PARAMETER	CONDITIONS	MIN.	MAX.	UNIT
$-V_{CBO}$	collector-base voltage		-	120	V
$-V_{CEO}$	collector-emitter voltage		-	120	V
$-I_C$	collector current		-	1	A
$P_{tot}$	total power dissipation	$T_{case} \leq 25\text{ }^\circ\text{C}$	-	10	W
		$T_{amb} \leq 25\text{ }^\circ\text{C}$	-	1	W
$T_j$	junction temperature		-	200	$^\circ\text{C}$
$h_{FE}$	current gain	$-V_{CE} = 2\text{ V}$ $-I_C = 250\text{ mA}$	40	150	
$f_T$	transition frequency	$-V_{CE} = 10\text{ V}$ $-I_C = 100\text{ mA}$	30	-	MHz
$-V_{CEsat}$	collector-emitter saturation voltage	$-I_B = 25\text{ mA}$ $-I_C = 250\text{ mA}$	-	0.6	V

## PINNING - TO-39

Collector connected to case.

PIN	DESCRIPTION
1	emitter
2	base
3	collector

## PIN CONFIGURATION

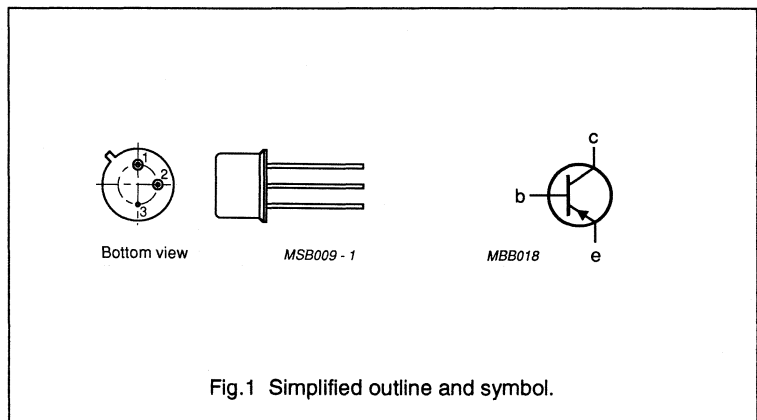

## LIMITING VALUES

In accordance with the Absolute Maximum System (IEC 134).

SYMBOL	PARAMETER	CONDITIONS	MIN.	MAX.	UNIT
$-V_{CBO}$	collector-base voltage	$I_E = 0$	-	120	V
$-V_{CEO}$	collector-emitter voltage	$I_B = 0$	-	120	V
$-V_{EBO}$	emitter-base voltage	$I_C = 0$	-	4	V
$-I_C$	collector current		-	1	A
$-I_B$	base current		-	0.5	A
$P_{tot}$	total power dissipation	$T_{case} \leq 25\text{ }^\circ\text{C}$	-	10	W
		$T_{amb} \leq 25\text{ }^\circ\text{C}$	-	1	W
$T_{stg}$	storage temperature range		-65	200	$^\circ\text{C}$
$T_j$	junction temperature		-	200	$^\circ\text{C}$

Silicon planar epitaxial transistor

2N5680

THERMAL RESISTANCE

SYMBOL	PARAMETER	VALUE	UNIT
$R_{th\ j-a}$	from junction to ambient	175	K/W
$R_{th\ j-c}$	from junction to case	17.5	K/W

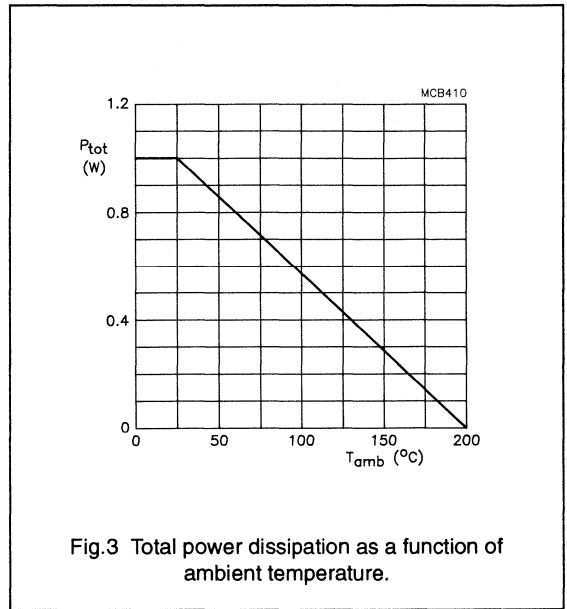
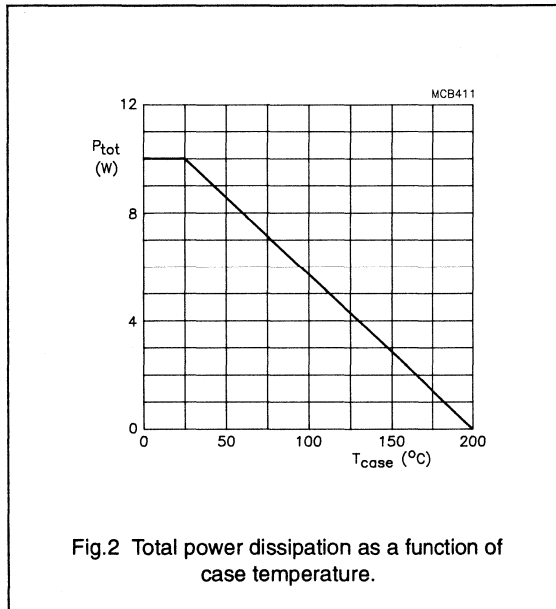



## Silicon planar epitaxial transistor

2N5680

## CHARACTERISTICS

 $T_{amb} = 25\text{ }^{\circ}\text{C}$  unless otherwise specified.

SYMBOL	PARAMETER	CONDITIONS	MIN.	MAX.	UNIT
$-V_{(BR)CEO}$	collector-emitter breakdown voltage	$I_B = 0$ $-I_C = 10\text{ mA}$	120	–	V
$-I_{CBO}$	collector-base cut-off current	$I_E = 0$ $-V_{CB} = 120\text{ V}$	–	1	$\mu\text{A}$
$-I_{CEO}$	collector-emitter cut-off current	$I_B = 0$ $-V_{CE} = 80\text{ V}$	–	10	$\mu\text{A}$
$-I_{CEX}$	collector-emitter cut-off current	$V_{EB} = 1.5\text{ V}$ $-V_{CE} = 120\text{ V}$	–	1	$\mu\text{A}$
		$V_{EB} = 1.5\text{ V}$ $-V_{CE} = 120\text{ V}$ $T_{case} = 150\text{ }^{\circ}\text{C}$	–	1	mA
$-I_{EBO}$	emitter-base cut-off current	$I_C = 0$ $-V_{EB} = 4\text{ V}$	–	1	$\mu\text{A}$
$-V_{CEsat}$	collector-emitter saturation voltage	$-I_B = 25\text{ mA}$ $-I_C = 250\text{ mA}$	–	0.6	V
		$-I_B = 50\text{ mA}$ $-I_C = 500\text{ mA}$	–	1	V
		$-I_B = 200\text{ mA}$ $-I_C = 1\text{ A}$	–	2	V
$-V_{BEsat}$	base-emitter saturation voltage	$-I_B = 25\text{ mA}$ $-I_C = 250\text{ mA}$	–	1	V
$h_{FE}$	current gain	$-V_{CE} = 2\text{ V}$ $-I_C = 250\text{ mA}$	40	150	
		$-V_{CE} = 2\text{ V}$ $-I_C = 1\text{ A}$	5	–	
$h_{fe}$	small signal current gain	$-V_{CE} = 1.5\text{ V}$ $-I_C = 200\text{ mA}$ $f = 1\text{ kHz}$	40	–	
$f_T$	transition frequency	$-V_{CE} = 10\text{ V}$ $-I_C = 100\text{ mA}$ $f = 10\text{ MHz}$	30	–	MHz
$C_c$	collector capacitance	$-V_{CB} = 20\text{ V}$ $I_E = 0$ $f = 1\text{ MHz}$	–	50	pF

## Silicon planar epitaxial transistor

2N5680

## PACKAGE OUTLINE

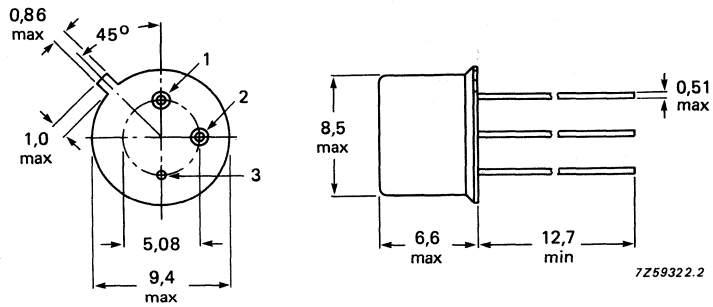

Dimensions in mm.

Fig.4 TO-39.



## SILICON SMALL-SIGNAL TRANSISTOR

PNP small-signal transistor, in a plastic TO-92 envelope.

It is intended for use in audio amplifier driver stages and low speed switching applications etc.

NPN complementary type is the 2PC945.

### QUICK REFERENCE DATA

Collector-base voltage (open emitter)	$-V_{CBO}$	max.	60 V
Collector-emitter voltage (open base)	$-V_{CEO}$	max.	50 V
Collector current (DC)	$-I_C$	max.	100 mA
Total power dissipation at $T_{amb} \leq 25^\circ\text{C}$	$P_{tot}$	max.	500 mW
Collector-emitter saturation voltage $-I_C = 100\text{ mA}; -I_B = 10\text{ mA}$	$-V_{CEsat}$	max.	0.3 V
DC current gain $-I_C = 1\text{ mA}; -V_{CE} = 6\text{ V}$	$h_{FE}$	min.	90
		max.	600

### MECHANICAL DATA

Dimensions in mm

Fig.1 TO-92

#### Pinning

- 1 = base
- 2 = collector
- 3 = emitter

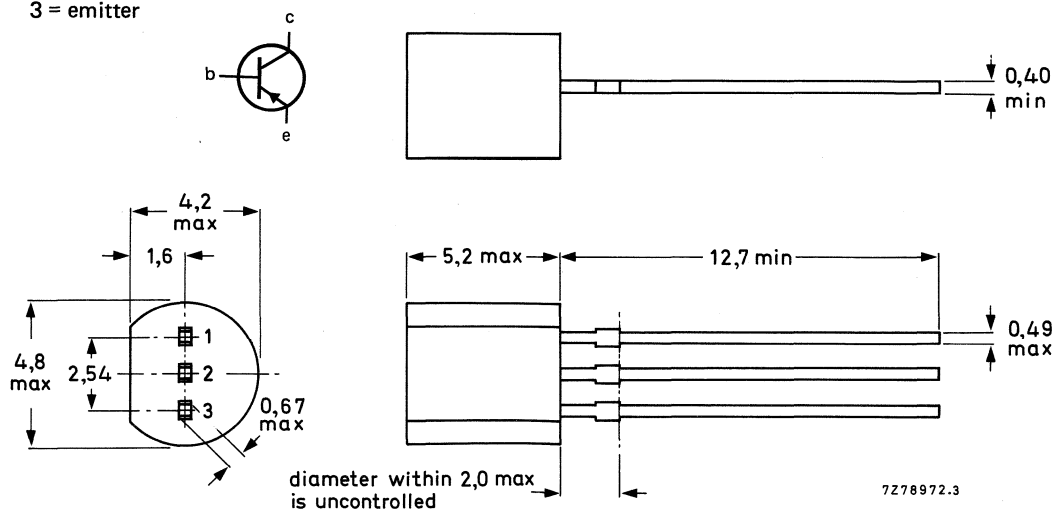

**RATINGS**

Limiting values in accordance with the Absolute Maximum System (IEC 134)

Collector-base voltage (open emitter)	$-V_{CBO}$	max.	60 V
Collector-emitter voltage (open base)	$-V_{CEO}$	max.	50 V
Emitter-base voltage (open collector)	$-V_{EBO}$	max.	5.0 V
Collector current (DC)	$-I_C$	max.	100 mA
Base current (DC)	$-I_B$	max.	20 mA
Total power dissipation at $T_{amb} \leq 25\text{ }^\circ\text{C}$	$P_{tot}$	max.	500 mW
Junction temperature	$T_j$	max.	150 $^\circ\text{C}$
Storage temperature range	$T_{stg}$		-65 to + 150 $^\circ\text{C}$

**THERMAL RESISTANCE**

From junction to ambient in free air	$R_{thj-a}$	=	250 K/W
--------------------------------------	-------------	---	---------

**CHARACTERISTICS** $T_j = 25\text{ }^\circ\text{C}$  unless otherwise specified

Collector cut-off current $-I_E = 0; -V_{CB} = 6\text{ V}$	$-I_{CBO}$	max.	100 nA
Emitter cut-off current $-I_C = 0; -V_{EB} = 5\text{ V}$	$-I_{EBO}$	max.	100 nA
DC current gain $-I_C = 1\text{ mA}; -V_{CE} = 6\text{ V}^*$	$h_{FE}$	min. max.	90 600
Collector-emitter saturation voltage $-I_C = 100\text{ mA}; -I_B = 10\text{ mA}$	$-V_{CEsat}$	max.	0.3 V
Base-emitter on-state voltage $-I_C = 1\text{ mA}; -V_{CE} = 6\text{ V}$	$-V_{BEon}$	min. max.	0.6 V 0.7 V
Transition frequency $-I_C = 10\text{ mA}; -V_{CE} = 6\text{ V}$	$f_T$	min. typ.	100 MHz 180 MHz
Collector-base capacitance $-I_E = 0; -V_{CB} = 10\text{ V}; f = 1\text{ MHz}$	$C_{ob}$	max. typ.	6.0 pF 4.5 pF
Noise figure $-I_C = 300\text{ }\mu\text{A}; -V_{CE} = 6\text{ V};$ $R_s = 2\text{ k}\Omega; f = 100\text{ Hz}$	F	max. typ.	20 dB 6.0 dB

\* Classification of  $h_{FE}$ 

Group	R	Q	P	K
Range	90 - 180	135 - 270	200 - 400	300 - 600



## SILICON SMALL-SIGNAL TRANSISTORS

PNP small-signal transistors, each in a plastic TO-92 envelope.

They are intended for use in audio amplifier driver stages and other general purpose applications.

NPN complementary types are 2PC1815 and 2PC1815L.

### QUICK REFERENCE DATA

Collector-base voltage (open emitter)	$-V_{CBO}$	max.	50 V
Collector-emitter voltage (open base)	$-V_{CEO}$	max.	50 V
Collector current (DC)	$-I_C$	max.	150 mA
Total power dissipation at $T_{amb} \leq 25\text{ }^\circ\text{C}$	$P_{tot}$	max.	500 mW
Collector-emitter saturation voltage $-I_C = 100\text{ mA}; -I_B = 10\text{ mA}$	$-V_{CEsat}$	max.	0.3 V
DC current gain $-I_C = 2\text{ mA}; -V_{CE} = 6\text{ V}$	$h_{FE}$	min.	120
		max.	700

### MECHANICAL DATA

Dimensions in mm

Fig.1 TO-92

#### Pinning

- 1 = base
- 2 = collector
- 3 = emitter

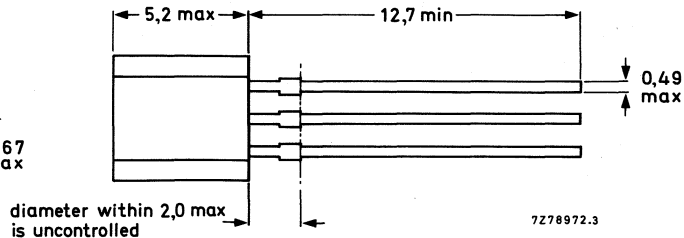
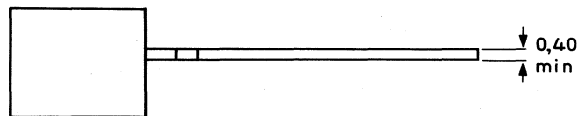
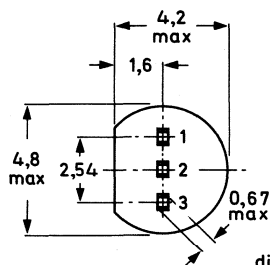
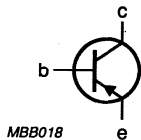

**RATINGS**

Limiting values in accordance with the Absolute Maximum System (IEC 134)

Collector-base voltage (open emitter)	$-V_{CB0}$	max.	50 V
Collector-emitter voltage (open base)	$-V_{CEO}$	max.	50 V
Emitter-base voltage (open collector)	$-V_{EB0}$	max.	5.0 V
Collector current (DC)	$-I_C$	max.	150 mA
Base current (DC)	$-I_B$	max.	50 mA
Total power dissipation at $T_{amb} \leq 25^\circ C$	$P_{tot}$	max.	500 mW
Junction temperature	$T_j$	max.	150 °C
Storage temperature range	$T_{stg}$		-65 to + 150 °C

**THERMAL RESISTANCE**

From junction to ambient in free air	$R_{th\ j-a}$	=	250 K/W
--------------------------------------	---------------	---	---------

**CHARACTERISTICS**

$T_j = 25^\circ C$  unless otherwise specified

Collector cut-off current $-I_E = 0; -V_{CB} = 50\ V$	$-I_{CB0}$	max.	100 nA
Emitter cut-off current $-I_C = 0; -V_{EB} = 5\ V$	$-I_{EB0}$	max.	100 nA
DC current gain $-I_C = 150\ mA; -V_{CE} = 6\ V$	$h_{FE}$	min.	25
$-I_C = 2\ mA; -V_{CE} = 6\ V^*$	$h_{FE}$	min.	120
		max.	700
Collector-emitter saturation voltage $-I_C = 100\ mA; -I_B = 10\ mA$	$-V_{CEsat}$	max.	0.3 V
Base-emitter saturation voltage $-I_C = 100\ mA; -I_B = 10\ mA$	$-V_{BEsat}$	max.	1.1 V
Transition frequency $-I_C = 1\ mA; -V_{CE} = 10\ V$	$f_T$	min.	80 MHz
Collector-output capacitance $-I_E = 0; -V_{CB} = 10\ V; f = 1\ MHz$	$C_{ob}$	typ.	4 pF
		max.	7 pF
Noise figure $-I_C = 100\ \mu A; -V_{CE} = 6\ V;$ $R_s = 10\ k\Omega; f = 1\ kHz$		max.	10 dB
	2PA1015	F	max.
	2PA1015L	F	6 dB

\* Classification of  $h_{FE}$

Group	Y	GR	BL
Range	120 - 240	200 - 400	350 - 700



## SILICON SMALL-SIGNAL TRANSISTOR

NPN small-signal transistor, in a plastic TO-92 envelope.

It is intended for use in audio amplifier driver stages and low speed switching applications etc.

PNP complementary type is the 2PA733.

### QUICK REFERENCE DATA

Collector-base voltage (open emitter)	$V_{CB0}$	max.	60 V
Collector-emitter voltage (open base)	$V_{CEO}$	max.	50 V
Collector current (DC)	$I_C$	max.	100 mA
Total power dissipation at $T_{amb} \leq 25^\circ C$	$P_{tot}$	max.	500 mW
Collector-emitter saturation voltage $I_C = 100 \text{ mA}; I_B = 10 \text{ mA}$	$V_{CEsat}$	max.	0.3 V
DC current gain $I_C = 1 \text{ mA}; V_{CE} = 6 \text{ V}$	$h_{FE}$	min.	90
		max.	600

### MECHANICAL DATA

Dimensions in mm

Fig.1 TO-92.

#### Pinning

1 = base

2 = collector

3 = emitter

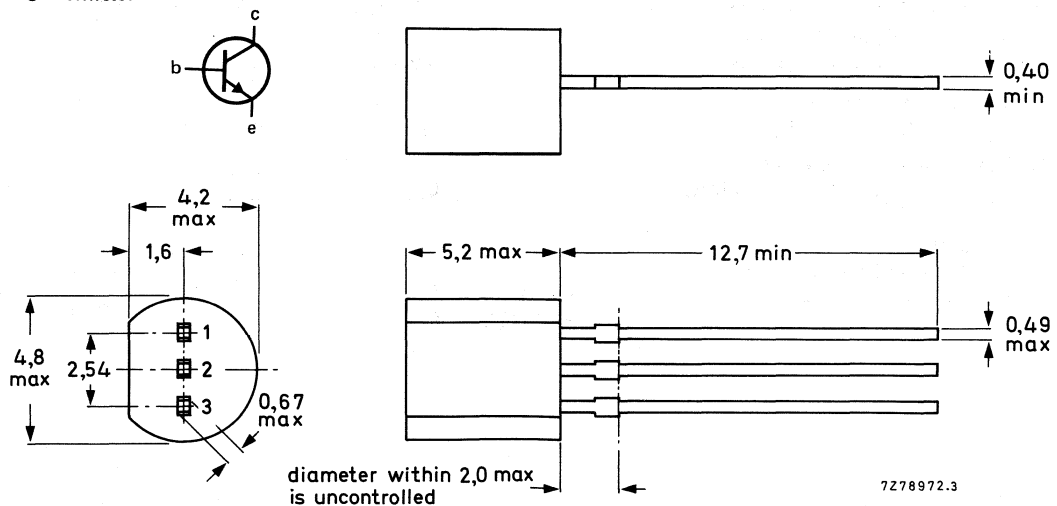

**RATINGS**

Limiting values in accordance with the Absolute Maximum System (IEC 134)

Collector-base voltage (open emitter)	$V_{CBO}$	max.	60 V
Collector-emitter voltage (open base)	$V_{CEO}$	max.	50 V
Emitter-base voltage (open collector)	$V_{EBO}$	max.	5.0 V
Collector current (DC)	$I_C$	max.	100 mA
Base current (DC)	$I_B$	max.	20 mA
Total power dissipation at $T_{amb} \leq 25\text{ }^\circ\text{C}$	$P_{tot}$	max.	500 mW
Junction temperature	$T_j$	max.	150 $^\circ\text{C}$
Storage temperature range	$T_{stg}$		-65 to + 150 $^\circ\text{C}$

**THERMAL RESISTANCE**

From junction to ambient in free air	$R_{th\ j-a}$	=	250 K/W
--------------------------------------	---------------	---	---------

**CHARACTERISTICS** $T_j = 25\text{ }^\circ\text{C}$  unless otherwise specified

Collector cut-off current $I_E = 0; V_{CB} = 60\text{ V}$	$I_{CBO}$	max.	100 nA
Emitter cut-off current $I_C = 0; V_{EB} = 5\text{ V}$	$I_{EBO}$	max.	100 nA
DC current gain $I_C = 0.1\text{ mA}; V_{CE} = 6\text{ V}$	$h_{FE}$	min.	50
$I_C = 1\text{ mA}; V_{CE} = 6\text{ V}^*$	$h_{FE}$	min. max.	90 600
Collector-emitter saturation voltage $I_C = 100\text{ mA}; I_B = 10\text{ mA}$	$V_{CEsat}$	max.	0.3 V
Base-emitter on-state voltage $I_C = 1\text{ mA}; V_{CE} = 6\text{ V}$	$V_{BEon}$	min. max.	0.6 V 0.7 V
Base-emitter saturation voltage $I_C = 100\text{ mA}; I_B = 10\text{ mA}$	$V_{BEsat}$	max.	1.1 V
Transition frequency $I_C = 10\text{ mA}; V_{CE} = 6\text{ V}$	$f_T$	min. max.	150 MHz 450 MHz
Collector-base capacitance $I_E = 0; V_{CB} = 6\text{ V}; f = 1\text{ MHz}$	$C_{ob}$	max.	4.0 pF
Noise figure $I_C = 100\text{ }\mu\text{A}; V_{CE} = 6\text{ V};$ $R_s = 2\text{ k}\Omega; f = 1\text{ kHz}$	$F$	max.	15 dB

\* Classification of  $h_{FE}$ 

Group	R	Q	P	K
Range	90 - 180	135 - 270	200 - 400	300 - 600





## SILICON SMALL-SIGNAL TRANSISTORS

NPN small-signal transistors, each in a TO-92 envelope.

They are intended for use in audio amplifier driver stages and other general purpose applications.

PNP complementary types are 2PA1015 and 2PA1015L.

### QUICK REFERENCE DATA

Collector-base voltage (open emitter)	$V_{CBO}$	max.	60 V
Collector-emitter voltage (open base)	$V_{CEO}$	max.	50 V
Collector current (DC)	$I_C$	max.	150 mA
Total power dissipation at $T_{amb} \leq 25^\circ C$	$P_{tot}$	max.	500 mW
Collector-emitter saturation voltage $I_C = 100 \text{ mA}; I_B = 10 \text{ mA}$	$V_{CEsat}$	max.	0.3 V
DC current gain $I_C = 2 \text{ mA}; V_{CE} = 6 \text{ V}$	$h_{FE}$	min.	120
		max.	700

### MECHANICAL DATA

Dimensions in mm

Fig.1 TO-92

#### Pinning

- 1 = base
- 2 = collector
- 3 = emitter

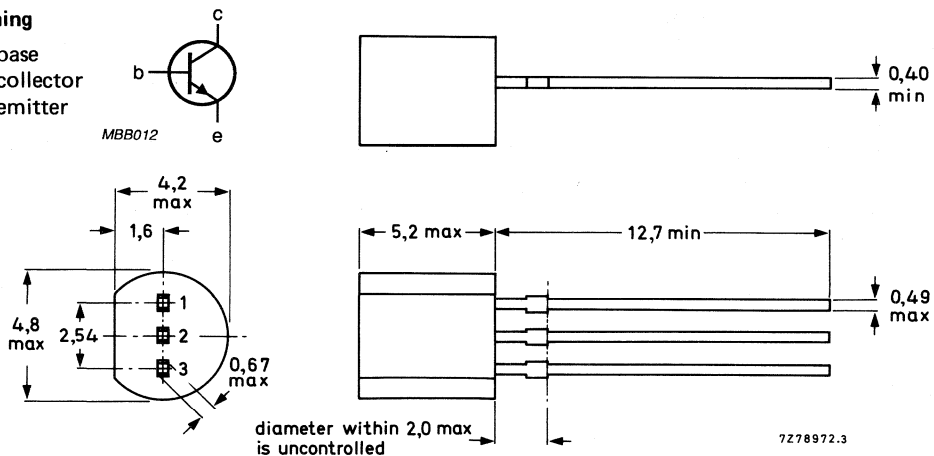

**RATINGS**

Limiting values in accordance with the Absolute Maximum System (IEC 134)

Collector-base voltage (open emitter)	$V_{CBO}$	max.	60 V
Collector-emitter voltage (open base)	$V_{CEO}$	max.	50 V
Emitter-base voltage (open collector)	$V_{EBO}$	max.	5.0 V
Collector current (DC)	$I_C$	max.	150 mA
Base current (DC)	$I_B$	max.	50 mA
Total power dissipation at $T_{amb} \leq 25^\circ C$	$P_{tot}$	max.	500 mW
Junction temperature	$T_j$	max.	150 °C
Storage temperature range	$T_{stg}$		-65 to + 150 °C

**THERMAL RESISTANCE**

From junction to ambient in free air	$R_{th\ j-a}$	=	250 K/W
--------------------------------------	---------------	---	---------

**CHARACTERISTICS**

$T_j = 25^\circ C$  unless otherwise specified

Collector cut-off current $I_E = 0; V_{CB} = 60\ V$	$I_{CBO}$	max.	100 nA
Emitter cut-off current $I_C = 0; V_{EB} = 5\ V$	$I_{EBO}$	max.	100 nA
DC current gain $I_C = 150\ mA; V_{CE} = 6\ V$	$h_{FE}$	min.	25
$I_C = 2\ mA; V_{CE} = 6\ V^*$	$h_{FE}$	max.	120
			700
Collector-emitter saturation voltage $I_C = 100\ mA; I_B = 10\ mA$	$V_{CEsat}$	max.	0.3 V
Base-emitter saturation voltage $I_C = 100\ mA; I_B = 10\ mA$	$V_{BEsat}$	max.	1.1 V
Transition frequency $I_C = 1\ mA; V_{CE} = 6\ V$	$f_T$	min.	80 MHz
Collector-output capacitance $I_E = 0; V_{CB} = 10\ V; f = 1\ MHz$	$C_{ob}$	max.	3.5 pF
		typ.	2.5 pF
Noise figure $I_C = 100\ \mu A; V_{CE} = 6\ V;$ $R_s = 10\ k\Omega; f = 1\ kHz$			
	2PC1815	F	max. 10 dB
			typ. 1 dB
	2PC1815L	F	max. 3 dB
			typ. 0.2 dB

\* Classification of  $h_{FE}$

Group	Y	GR	BL
Range	120 - 240	200 - 400	350 - 700

## INDEX



## Small-signal Transistors

## Index

TYPE NUMBER	PAGE	TYPE NUMBER	PAGE	TYPE NUMBER	PAGE
BC107	71	BC640	181	BF484	297
BC108	71	BC875	187	BF485	293
BC109	71	BC876	191	BF486	297
BC140	85	BC877	187	BF487	293
BC141	85	BC878	191	BF488	297
BC160	89	BC879	187	BF494	301
BC161	89	BC880	191	BF495	303
BC177	93	BCX22	195	BF496	305
BC178	93	BCX23	199	BF926	309
BC179	93	BCX58	203	BF970	311
BC327	105	BCX59	203	BFR54	313
BC327A	105	BCX78	207	BFT44	321
BC328	105	BCX79	207	BFT45	321
BC337	111	BCY56	211	BFX29	329
BC337A	111	BCY57	211	BFX30	343
BC338	111	BCY58	215	BFX34	355
BC368	117	BCY59	215	BFX84	361
BC369	125	BCY65	225	BFX85	361
BC375	133	BCY70	229	BFX87	381
BC376	135	BCY71	229	BFX88	381
BC516	137	BCY72	229	BFY50	395
BC517	139	BCY78	245	BFY51	395
BC546	141	BCY79	245	BRY52	395
BC547	141	BCY87	253	BFY55	415
BC548	141	BCY88	253	BR101	427
BC549	149	BCY89	253	BRY39(P)	431
BC550	149	BF198	261	BRY39(S)	437
BC556	159	BF199	265	BRY56	445
BC557	159	BF240	267	BSR50	449
BC558	159	BF241	267	BSR51	449
BC559	165	BF324	269	BSR52	449
BC560	165	BF370	275	BSR60	455
BC617	173	BF420	279	BSR61	455
BC618	173	BF421	285	BSR62	455
BC635	175	BF422	279	BSS38	461
BC636	181	BF423	285	BSS50	465
BC637	175	BF450	291	BSS51	465
BC638	181	BF451	291	BSS52	465
BC639	175	BF483	293	BSS60	473

## Small-signal Transistors

## Index

TYPE NUMBER	PAGE	TYPE NUMBER	PAGE	TYPE NUMBER	PAGE
BSS61	473	JC558	599	MPSA76	645
BSS62	473	JC559	603	MPSA77	645
BSS68	481	JC560	603	MPSA92	647
BSV15	485	JF494	607	MPSA93	647
BSV16	485	MPS3702	609	PH2222	649
BSV17	485	MPS3703	609	PH2222A	649
BSV64	495	MPS3704	611	PH2369	653
BSW66A	501	MPS3705	611	PH2907	663
BSW67A	501	MPS3706	611	PH2907A	663
BSW68A	501	MPS3904	613	PH5415	667
BSX20	509	MPS3906	617	PH5416	667
BSX32	525	MPS6513	621	PN2222	669
BSX45	529	MPS6514	621	PN2222A	669
BSX46	529	MPS6515	621	PN2369	673
BSX47	529	MPS6517	623	PN2369A	673
BSX49	541	MPS6518	623	PN2907	677
BSX59	545	MPS6519	623	PN2907A	677
BSX60	545	MPS6520	625	PN3439	681
BSX61	545	MPS6521	625	PN3440	681
BSX62	557	MPS6522	627	PN5415	683
BSX63	557	MPS6523	627	PN5416	683
BSY95A	565	MPS6531	629	2N930	685
JA100	569	MPS6532	629	2N1613	689
JA101	569	MPS6534	631	2N1711	697
JC327	573	MPS6535	631	2N1893	701
JC327A	573	MPSA05	633	2N2219	705
JC328	573	MPSA06	633	2N2219A	705
JC337	577	MPSA13	635	2N2222	711
JC337A	577	MPSA14	635	2N2222A	711
JC338	577	MPSA25	637	2N2297	717
JC500	581	MPSA26	637	2N2369	721
JC501	581	MPSA27	637	2N2369A	725
JC546	585	MPSA42	639	2N2483	729
JC547	585	MPSA43	639	2N2484	729
JC548	585	MPSA55	641	2N2646	733
JC549	595	MPSA56	641	2N2894A	737
JC550	595	MPSA63	643	2N2904	743
JC556	599	MPSA64	643	2N2904A	743
JC557	599	MPSA75	645	2N905	751

## Small-signal Transistors

## Index

TYPE NUMBER	PAGE
2N2905A	751
2N2906	755
2N2906A	755
2N2907	759
2N2907A	759
2N3019	763
2N3020	763
2N3053	767
2N3439	769
2N3440	769
2N3904	771
2N3906	775
2N4030	779
2N4031	779
2N4032	779
2N4033	779
2N4036	783
2N4123	785
2N4124	785
2N4125	787
2N4126	787

TYPE NUMBER	PAGE
2N4400	789
2N4401	789
2N4402	793
2N4403	793
2N5086	797
2N5087	797
2N5088	801
2N5400	803
2N5401	803
2N5415	807
2N5416	807
2N5550	811
2N5551	811
2N5680	815
2PA733	819
2PA1015	821
2PA1015L	821
2PC945	823
2PC1815	825
2PC1815L	825

---

## NOTES

---



**DATA HANDBOOK SYSTEM**

**INTRODUCTION**

Our data handbook system comprises more than 65 books with subjects including electronic components, subassemblies and magnetic products. The handbooks are classified into seven series:

INTEGRATED CIRCUITS;  
DISCRETE SEMICONDUCTORS;  
DISPLAY COMPONENTS;  
PASSIVE COMPONENTS;  
PROFESSIONAL COMPONENTS;  
MAGNETIC PRODUCTS;  
LIQUID CRYSTAL DISPLAYS.

Data handbooks contain all pertinent data available at the time of publication and each is revised and reissued regularly.

Loose data sheets are sent to subscribers to keep them up-to-date on additions or alterations made during the lifetime of a data handbook.

Catalogues are available for selected product ranges (some catalogues are also on floppy discs).

For more information about data handbooks, catalogues and subscriptions, contact one of the organizations listed on the back cover of this handbook. Product specialists are at your service and enquiries are answered promptly.

**INTEGRATED CIRCUITS**

IC01	Semiconductors for Radio and Audio Systems
IC02	Semiconductors for Television and Video Systems
IC03	Semiconductors for Telecom Systems
IC04	CMOS HE4000B Logic Family
IC05	Advanced Low-power Schottky (ALS) Logic Series
IC06	High-speed CMOS Logic Family
IC08	ECL 100K ECL Logic Family
IC10	Memories
IC11	General Purpose/Linear ICs
IC12	Display Drivers and Microcontroller Peripherals

**INTEGRATED CIRCUITS (continued)**

IC13	Programmable Logic Devices (PLD)
IC14	8048-based 8-bit Microcontrollers
IC15	FAST TTL Logic Series
IC16	ICs for Clocks and Watches
IC18	Semiconductors for In-Car Electronics and General Industrial Applications
IC19	Semiconductors for Datacom: LANs, UARTs, Multi-Protocol Controllers and Fibre Optics
IC20	8051-based 8-bit Microcontrollers
IC21	68000-based 16-bit Microcontrollers
IC22	ICs for Multi-Media Systems
IC23	QUBIC Advanced BiCMOS Interface Logic ABT, MULTIBYTE™
IC24	Low Voltage CMOS Logic

**DISCRETE SEMICONDUCTORS**

SC01	Diodes
SC02	Power Diodes
SC03	Thyristors and Triacs
SC04	Small Signal Transistors
SC05	Low-frequency Power Transistors and Hybrid IC Power Modules
SC06	High-voltage and Switching Power Transistors
SC07	Small-signal Field-effect Transistors
SC08a	RF Power Bipolar Transistors
SC08b	RF Power MOS Transistors
SC09	RF Power Modules
SC10	Surface Mounted Semiconductors
SC12	Optocouplers
SC13	PowerMOS Transistors
SC14	Wideband Transistors and Wideband Hybrid IC Modules
SC15	Microwave Transistors
SC16	Wideband Hybrid IC Modules
SC17	Semiconductor Sensors

**DISPLAY COMPONENTS**

- DC01 Colour Display Components  
Colour TV Picture Tubes and Assemblies  
Colour Monitor Tube Assemblies
- DC02 Monochrome Monitor Tubes and Deflection  
Units
- DC03 Television Tuners, Coaxial Aerial Input  
Assemblies
- DC04 Loudspeakers
- DC05 Flyback Transformers, Mains Transformers  
and General-purpose FXC Assemblies

**PASSIVE COMPONENTS**

- PA01 Electrolytic Capacitors
- PA02 Varistors, Thermistors and Sensors
- PA03 Potentiometers and Switches
- PA04 Variable Capacitors
- PA05 Film Capacitors
- PA06 Ceramic Capacitors
- PA07 Quartz Crystals for Special and Industrial  
Applications
- PA08 Fixed Resistors
- PA10 Quartz Crystals for Automotive and Standard  
Applications
- PA11 Quartz Oscillators

**PROFESSIONAL COMPONENTS**

- PC01 High-power Klystrons and Accessories
- PC02 Cathode-ray Tubes
- PC03 Geiger-Müller Tubes
- PC04 Photo Multipliers
- PC05 Plumbicon Camera Tubes and Accessories
- PC06 Circulators and Isolators
- PC07 Vidicon and Newvicon Camera Tubes and  
Deflection Units
- PC08 Image Intensifiers
- PC09 Dry-reed Switches
- PC11 Solid-state Image Sensors and Peripheral  
Integrated Circuits
- PC12 Electron Multipliers

**MAGNETIC PRODUCTS**

- MA01 Soft Ferrites
- MA02 Permanent Magnets
- MA03 Piezoelectric Ceramics

**LIQUID CRYSTAL DISPLAYS**

- LCD01 Liquid Crystal Displays and Driver ICs for  
LCDs





## *Philips Semiconductors – a worldwide company*

- Argentina** IEROD, St. Juramento 1991 - 14 B, Buenos Aires.  
Zip Code 1428, Phone/Fax: 54 1 7869367
- Australia** 34 Waterloo Road, NORTH RYDE, NSW 2113,  
Tel. (02)8054455, Fax. (02)8054466
- Austria** Triester Str. 64, 1101 WIEN,  
Tel. (0222)60 101-0, Fax. (0222)60 101-1975
- Belgium** 80 Rue Des Deux Gares, B-1070 BRUXELLES,  
Tel. (02)5256111, Fax. (02)5257246
- Brazil** Rua do Rocia 220, SAO PAULO-SP, CEP 4552,  
P.O. Box 7383, CEP 01051, Tel. (011)829-1166,  
Fax. (011)829-1849
- Canada** DISCRETE SEMICONDUCTORS, 601 Milner Ave,  
SCARBOROUGH, ONTARIO, M1B 1M8,  
Tel. (416)292-5161  
INTEGRATED CIRCUITS, 1 Eva Road, Suite 411, ETOBICOKE,  
Ontario, M9C 4Z5, Tel. (416)626-6676
- Chile** Av. Santa Maria 0760, SANTIAGO,  
Tel. (02)773816
- Colombia** Carrera 21 No. 56-17, BOGOTA, D.E., P.O. Box 77621,  
Tel. (01)2497624
- Denmark** Prags Boulevard 80, PB 1919, DK-2300 COPENHAGENS,  
Tel. 32-883333, Fax. 32-960125
- Finland** Sinikalliontie 3, SF-2630 ESPOO,  
Tel. 358-0-50261, Fax. 358-0-520039
- France** 117 Quai du Président Roosevelt, 92134 ISSY-LES-  
MOULINEAUX Cedex, Tel. (01)40938000,  
Fax. (01)40938127
- Germany** Burchardsstrasse 19, D-2 HAMBURG 1,  
Tel. (040)3296-0, Fax. (040)3296213
- Greece** No. 15, 25th March Street, GR 17778 TAVROS,  
Tel. (01)4894 339/4894 911
- Hong Kong** 15/F Philips Ind. Bldg., 24-28 Kun Yip St., KWAI CHUNG,  
Tel. (0)-4245121, Fax. (0)4806960
- India** Shivsagar Estate 'A' Block, P.O. Box 6598, 254-D Dr. Annie  
Besant Rd., BOMBAY-40018, Tel. (022)4921500-4921 515,  
Fax. (022)49419063
- Indonesia** Setiabudi 11 Building, 6th Fl., Jalan H.R. Rasuna Said,  
P.O. Box 223/KBY, Kuningan, JAKARTA 12910,  
Tel. (021)51 7995
- Ireland** Newstead, Clonskeagh, DUBLIN 14,  
Tel. (01)693355, Fax. (01)697856
- Italy** Piazza IV Novembre 3, I-20124 MILANO,  
Tel. (02)67522642, Fax. (02)67522648
- Japan** Philips Bldg 13-37, Kohnan 2-chome, Minato-ku, TOKIO 108,  
Tel. (03)813-3740-5101, Fax. (03)81337400570
- Korea (Republic of)** Philips House, 260-199 Itaewon-dong,  
Yongsan-ku, SEOUL, Tel. (02)794-5011, Fax. (02)798-8022
- Malaysia** 3 Jalan SS15/2A SUBANG, 47500 PETALING JAYA,  
Tel. (03)7345511, Fax. (03)7345494
- Mexico** Paseo Triunfo de la Republica, No. 215 Local 5, Cd Juarez  
CHI HUA HUA 32340, Tel. (16)18-67-01/02
- Netherlands** Postbus 90050, 5600 PB EINDHOVEN,  
Tel. (040)783749, Fax. (040)788399
- New Zealand** 2 Wagener Place, C.P.O. Box 1041, AUCKLAND,  
Tel. (09)894-160, Fax. (09)897-811
- Norway** Box 1, Manglerud 0612, OSLO,  
Tel. (02)748000, Fax. (02)748341
- Pakistan** Philips Markaz, M.A. Jinnah Rd., KARACHI-3,  
Tel. (021)725772
- Peru** Carretera Central 6.500, LIMA 3, Apartado 5612,  
Tel. 51-14-350059
- Philippines** PHILIPS SEMICONDUCTORS PHILIPPINES Inc,  
106 Valero St. Salcedo Village, P.O. Box 911, MAKATI,  
Metro MANILA, Tel. (63-2)810-0161, Fax. (63-2)8173474
- Portugal** Av. Eng. Duarte Pacheco 6, 1009 LISBOA Codex,  
Tel. (019)683121, Fax. (019)658013
- Singapore** Lorong 1, Toa Payoh, SINGAPORE 1231,  
Tel. 3502000, Fax. 2516500
- South Africa** 195-215 Main Road, JOHANNESBURG 2000,  
P.O. Box 7430, Tel. (011)8893911, Fax. (011)8893191
- Spain** Balmes 22, 08007 BARCELONA,  
Tel. (03)3016312, Fax. (03)3014243
- Sweden** Tegeluddsvägen 1, S-11584 STOCKHOLM,  
Tel. (0)8-7821000, Fax. (0)8-6603201
- Switzerland** Allmendstrasse 140-142, CH-8027 ZÜRICH,  
Tel. (01)4882211, FAX. (01)4828595
- Taiwan** 581 Min Sheng East Road, P.O. Box 22978 TAIPEI 10446,  
Tel. 886-2-5097666, Fax. 88625005899
- Thailand** PHILIPS ELECTRICAL Co. of THAILAND Ltd.,  
60/14 MOO 11, Bangna - Trad Road Km. 3  
Prakanong, BANGKOK 10260,  
Tel. (66-2)399-3280 to 9, (66-2)398-2083,  
Fax. (66-2)398-2080
- Turkey** Talatpasa Cad. No. 5, 80640 LEVENT/ISTANBUL,  
Tel. (01)1792770, Fax. (01)1693094
- United Kingdom** Philips Semiconductors Limited, P.O. Box 65,  
Philips House, Torrington Place, LONDON, WC1E 7HD,  
Tel. (071)4364144, Fax. (071)3230342
- United States** INTEGRATED CIRCUITS, 811 East Arques Avenue,  
SUNNYVALE, CA 94088-3409, Tel. (800)227-1817, Ext. 900,  
Fax. (408)991-3581  
DISCRETE SEMICONDUCTORS, 2001 West Blue Heron Blvd.,  
P.O. Box 10330, RIVIERA BEACH, FLORIDA 33404,  
Tel. (407)881-3200, Fax. (407)881-3300
- Uruguay** Coronel Mora 433, MONTEVIDEO,  
Tel. (02)70-4044
- Venezuela** Calle 6, Ed. Las Tres Jotas, CARACAS, 1074A,  
App. Post. 78117, Tel. (02)2417509
- Zimbabwe** 62 Mutare Road, HARARE, P.O. Box 994,  
Tel. 47211

**For all other countries apply to:** Philips Semiconductors,  
International Marketing and Sales, Building BAF-1,  
P.O. Box 218, 5600 MD, EINDHOVEN, The Netherlands,  
Telex 35000 phtnl, Fax. +31-40-724825

SCD7 © Philips Export B.V. 1992

All rights are reserved. Reproduction in whole or in part is prohibited  
without the prior written consent of the copyright owner.

The information presented in this document does not form part of  
any quotation or contract, is believed to be accurate and reliable and  
may be changed without notice. No liability will be accepted by the  
publisher for any consequence of its use. Publication thereof does  
not convey nor imply any license under patent- or other industrial or  
intellectual property rights.

Printed in the Netherlands Date of release: 7-92 9398 183 30011

# Philips Semiconductors



# PHILIPS